

The logo for ZIEHER, featuring the brand name in a bold, black, sans-serif font. A vibrant pink arc is positioned above the letters 'I' and 'E', partially overlapping them.

ZIEHER



2019
PROFESSIONAL



stands for innovative design and high-grade craftsmanship of numerous materials. The present catalogue of our Zieher professional range shall be understood as creative inspiration and assistant to satisfy even the highest demands of food- and merchandise presentation.



The demands of gourmet restaurants as well as those of suites and executive lounges in the best hotels worldwide serve as pulse generator and inspiration for new products. The Zieher range, which is distributed in over 90 countries, comprises approximately 1200 items which impress by their exquisite materials as well as their high standard in both design and quality.

Manfred Zieher

All information about Zieher and the complete product range is available at www.zieher.com.

"Star" page 190



"Bento-Tray" page 120



Page 86



Etagere "DressCoat" page 77



Buffet

5

- buffet displays: "Textura" - "Somnia" - "Spike"
- buffet displays: "Crossline"
- buffet systems: "Skyline" - "Squareline" - "Curve"
- The Zieher-System: "Konkret!" - "Luxor" - "V12" - "Basic" - "Classy" - "Solid" - "Antique" - "Lightning Buffet"
- cooling element "Chiller-Base"
- buffet platters made of laminated plastic, glass and natural stone, buffet steps made of glass
- buffet stands "Stablo"
- buffet bowls made of pewter alloy, stoneware, shell, brass, glass, stainless steel, china and walnut
- buffet etageres
- serving tongs
- "Fingerfood Tree"
- buffet bridges and trays "Podia"
- serving trays and buffet systems made of walnut: "Mercato" - "Solid"

Catering

119

- "Bento Box"
- melamine trays and accessories
- serving trays and cutlery boxes
- tray system "Modul": walnut - melamine - glass and china inserts

China, glass and more!

140

- main series and small series made of china / glass
- china plates, platters, trays, bowls and small bowls
- glass plates, platters, trays, bowls and small bowls
- shell series "Capiz"
- cloches made of glass and china
- charger plates

Wine glasses and more!

189

- wine decanter / carafe "Star"
- wine decanter "Eddy"
- wine glass series VISION
- wine decanter "Pebble"
- champagne flute VAGANZA

Miniatures

203

- anti-slip coasters made of silicone
- glass miniatures, borosilicate glass, double-walled glass
- china miniatures
- party cutlery, amuse gueule / tapas spoons, glass and honey spoons
- stainless steel miniatures
- skewers and natural stone

Cruet stands, trays, etageres and more!

241

- trays made of melamine and wood
- chocolate / truffles box, suitable inserts made of solid surface material
- bread baskets / boxes, trays and snack boards made of walnut
- etageres made of stainless steel
- jam trays and food displays
- vinegar / oil bottles
- cruet stands and trays with suitable inserts
- trays made of melamine and glass with 3 / 4 sockets for inserts
- wind lights, candlesticks and accessories

Room service / guestrooms

285

- roomservice trays and accessories
- storage / presentation boxes, cutlery box "Solid"
- trays made of shell "Capiz"
- bowls and baskets made of brass and pewter
- displays and trays "Podia"
- coat rack "Kibu"

List of items in ascending order

299

Table of content

305

WWW.ZIEHER.COM

PHOTOGRAPHY: www.die-lichtzeichner.de

"Design by Zieher" - our motto for 14 years!

In the year 2006 we designed the first items ourselves and placed them on the market. Since that time developing and implementing exclusive design objects has been our calling. On this page we show a couple of the most important creations of the past years.



Design, innovation and quality are our mission!

The Zieher Design History



2006



2008



2010



2012



2014



2016

2017

2009



2011



2013



2015



2018



Plateau plates, page 89



"Solid", pages 102/103



"Pebble", page 201



Melamine, pages 122-126



NEWS 2019!

"Flower-Tower", page 87



"Unique", pages 146 / 147

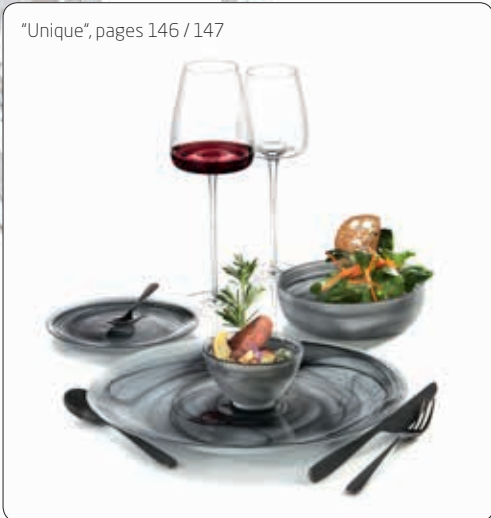

"Pulsar", page 140



"Bento Box", pages 120 / 121



Amuse gueule stand, page 86



Buffet



Etagere "DressCoat", page 77



The cloches and porcelain coasters of the series „Cuspis“ are available on page 142 and 205.

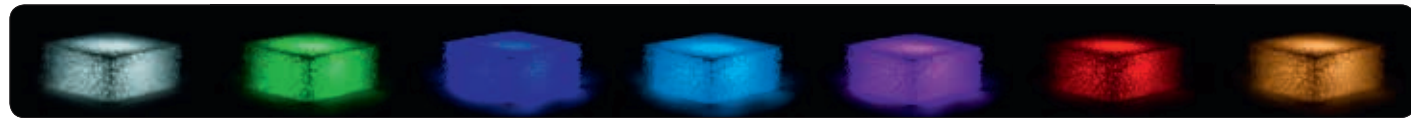

In order to grant a harmonic all-over illumination while using stacked cuboids it is recommended to use one LED lamp per item. For usage of bigger buffet platters we suggest to employ the elements with 30 cm edge length. Due to the flexible material we recommend stacking a maximum of two cubes on top of each other, when the system is equipped with heavy platters or bowls.



Precisely fitting recess for ZIEHER LED lights (page 40 / 41)



buffet display “Textura”
polyethylene, transparent, with notch for rechargeable LED-light item 8150

item	l x w x h in cm
8232.24	approx. 24x24x10,5
8232.30	approx. 30x30x10,5

“Textura” - indestructible, innovative, exclusive!

The exclusive cuboids of the „Textura“ series are exceedingly interesting, even at a second glance, due to their awesome structure. They consist of thin polyethylene filaments which are convoluted intricately and fused together. This awards them a flexible but nevertheless very stable texture. The true potential of this innovative material is only disclosed in connection with light. The light-conducting properties of the filigree filaments manifest effectively when using the rechargeable Zieher LED light, which fits exactly into the cut-outs on the bottom side of the displays.

The “Textura” buffet cuboids are available in two sizes which, when used separately or stacked on top of each other, create different presentation levels on the buffet. Buffet platters and trays are reliably kept in position due to the non-slip features of this material. “Textura” lives up to the high demands of gastronomy and catering in numerous ways. The displays are indestructible and very light, washable and dirt-repellent. The countless interspaces create a light-flooded meshwork which dries very quickly and is therefore resistant to humidity and mold. Also the raw material itself is something to be proud of. Polyethylene can repeatedly be 100% recycled without losing its outstanding characteristics. It is non-hazardous physiologically, odorless, tasteless and resistant to a variety of acids, oils and grease.



All information about the cooling elements “Chiller Base” can be found on pages 42 and 43.



2386.10 + 4814.40 + 4685

2385.01 + 4814.17

2385.02 + 4814.23

At first glance the golden branches, carefully strapped to a bundle, are reminiscent of a besom and braided objects of a different kind. The buffet displays and luminaires of the “Somnia” series are assembled from organically shaped, filigree rods which are made of solid brass in traditional sand casting. These single components, reminiscent of brittle branches, are afterwards melded in complex handicraft to impressive unique pieces. The matt-golden surface of the “Somnia” series harmonises elegantly with the grey glass of the handblown bowls which have been specially adapted to the shape of the small stands. The two bigger buffet raisers form a precious basis for bowls and buffet platters of all kind. Optionally available black rubber caps can be fixed on demand to improve the slip resistance and to protect the sensitive surface of furniture. The smallest version of these little pieces of art impresses also at a set table. An amuse bouche, bedded on a nest of golden branches, will be treasured by the guests for a long time.



candle holder/wind light “Somnia”

brass, golden, matt, not dishwasher-safe, for glass insert item 4991.02 (please order separately) and candles up to Ø 7 cm

item	Ø foot in cm	Ø top in cm	height in cm
2383.01	11	approx. 16.5	approx. 19.5



wind light

borosilicate glass, satined inside, open at the top and at the bottom, for candle holder/wind light “Somnia” item 2383.01

item	Ø in cm	height in cm	PU
4991.02	9	14.5	6 pcs



buffet display “Somnia”

brass, golden, matt, not dishwasher-safe

item	Ø in cm	height in cm
2386.10	approx. 21.5	approx. 10.5
2386.20	approx. 21.5	approx. 20.5



display for bowls “Somnia”

brass, golden, matt, not dishwasher-safe

item	Ø in cm	height in cm	for glass bowl
2385.01	approx. 15.5	approx. 13.5	4814.17
2385.02	approx. 23.5	approx. 22.5	4814.23



glass bowl

dark grey, round, handblown, ground edge

item	Ø in cm	height in cm	content in l
4814.17	17	5.5	approx. 0.3
4814.23	23	9.5	approx. 1.5
4814.30	30	13	approx. 3.25
4814.40	40	10	approx. 4.5

protecting cap

rubber, black, for buffet display “Somnia” items 2386...

item	Ø in mm	PU
4685	4	10 pcs



The wind light of the “Somnia” series is equipped with a solid base plate with an elevated rim. This base avoids a leakage of wax and protects the table surface from heat. Furthermore it forms the frame for a removable cylinder, made of heat resistant glass, which by way of its satined surface intensifies the mood of light and protects the flame from wind at the same time. With candle-light this extraordinary lighting object creates fascinating effects and provides for a cosy and comfortable ambience.



"Spike"

"Spike"

Modern and compact - bowl displays "Spike"

The anthracite coloured displays of the "Spike" series consist of translucent acrylic with a silk-matt surface. They are an elegant combination of shapely elements with a flexibility suitable for everyday usage. As the stands have been adapted exactly to the grey glass bowls belonging to the series, they form a harmonious picture and additionally provide a safe stand. A combination of the stands/trestles with buffet platters - even in a flipped position - is also possible and increases the usefulness of the displays enormously.

The plug connections between the single items are very practical. They are compatible with one another within one size of stands, which guarantees a maximum of variability and creative freedom. Existing elements can therefore be newly arranged and extended almost arbitrarily by buying additional single items.

The displays of the "Spike" series are available in ten single units for several bowl sizes as well as ten pre-configured sets. Optionally available wooden transport and storage boxes simplify a space-saving storage of the single pieces.



buffet display "Spike" S - parts
acrylic glass, 6 mm thick, anthracite, satined, translucent, size S for glass bowl item 4814.17

item	version	l x h in cm
a) 8260.10	top part onefold	11,6x6
b) 8260.1U	bottom part onefold	11,6x6
c) 8260.20	top part twofold	30,3x6
d) 8260.2U	bottom part twofold	30,3x6



buffet display "Spike" M - parts
acrylic glass, 6 mm thick, anthracite, satined, translucent, size S for glass bowl item 4814.23 and 4814.30

item	version	l x h in cm
a) 8261.10	top part onefold	20,8x10
b) 8261.1U	bottom part onefold	20,8x10
c) 8261.20	top part twofold	52,6x10
d) 8261.2U	bottom part twofold	52,6x10

buffet display "Spike" L - parts
acrylic glass, 6 mm thick, anthracite, satined, translucent, size S for glass bowl item 4814.40

item	version	l x h in cm
a) 8262.10	top part onefold	24,7x9
b) 8262.1U	bottom part onefold	24,7x9



glass bowl
dark grey, round, handblown, ground edge

item	Ø in cm	height in cm	content in l
4814.17	17	5,5	approx. 0,3



glass bowl
dark grey, round, handblown, ground edge

item	Ø in cm	height in cm	content in l
4814.23	23	9,5	approx. 1,5
4814.30	30	13	approx. 3,25



glass bowl
dark grey, round, handblown, ground edge

item	Ø in cm	height in cm	content in l
4814.40	40	10	approx. 4,5

"Spike" offers numerous possible ways of combination and extension. We have a selection of different preconfigured sets in our assortment, which can be combined with each other or extended with the also available individual parts.



buffet display "Spike", set S

acrylic glass, 6 mm thick, anthracite, satined, translucent, pluggable

item	consists of items	for glass bowl item
a) 8260.01	8260.10 (1x) / 8260.1U (1x)	4814.17
b) 8260.02	8260.10 (2x) / 8260.2U (1x)	4814.17
c) 8260.03	8260.10 (1x) / 8260.1U (1x) / 8260.20 (1x) / 8260.2U (1x)	4814.17
d) 8260.04	8260.20 (2x) / 8260.2U (2x)	4814.17
e) 8260.05	8260.10 (2x) / 8260.20 (1x) / 8260.2U (2x)	4814.17



buffet display "Spike", set M

acrylic glass, 6 mm thick, anthracite, satined, translucent, pluggable

item	consists of items	for glass bowl item
a) 8261.01	8261.10 (1x) / 8261.1U (1x)	4814.23 and 4814.30
b) 8261.02	8261.10 (2x) / 8261.2U (1x)	4814.23 and 4814.30
c) 8261.03	8261.10 (1x) / 8261.1U (1x) / 8261.20 (1x) / 8261.2U (1x)	4814.23 and 4814.30
d) 8261.04	8261.20 (2x) / 8261.2U (2x)	4814.23 and 4814.30



buffet display "Spike", set L
acrylic glass, 6 mm thick, anthracite, satined, translucent, pluggable

item	consists of items	for glass bowl item
8262.01	8262.10 (1x) / 8262.1U (1x)	4814.40



storage/transportation box
veneer plywood, dovetailed corners, 1 divider

item	l x w x h in cm	for buffet display "Spike" item
5665.01	34x16x8,5	8260...
5665.02	56x25x13	8261... and 8262...



More dark grey glass bowls are available on pages 70 and 71.



Hinged beams at the upper side of the trestle can be adjusted individually to the shape of bowls and platters.

buffet bowl
glass, 8 mm thick, dark grey, oval, structured, delivery in strong wooden box

item	l x w x h in cm
5176	130x42x8

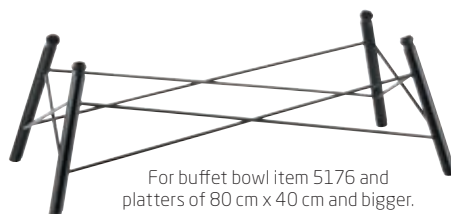

buffet stand “Crossline”
galvanised steel, matt black (powder coating), rectangular, hinged beams on top

item	l x w x h in cm	l x w in cm (on top)
8325.23	70.5x33.5x23.5	59.5x22

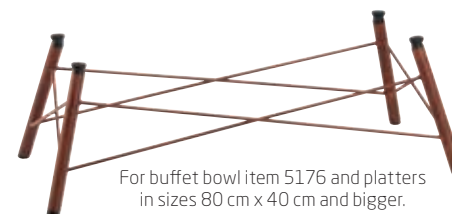

buffet stand “Crossline” - rust
steel, rusted surface, transparent sealing, rectangular, hinged beams on top

item	l x w x h in cm	l x w in cm (on top)
8325.23R	70.5x33.5x23.5	59.5x22



buffet stand “Crossline”
galvanised steel, matt black (powder coating), square, hinged beams on top

item	l x w x h in cm	l x w in cm (on top)
8320.15	41.5x41.5x15.5	34x34
8320.31	49.5x49.5x31	34x34

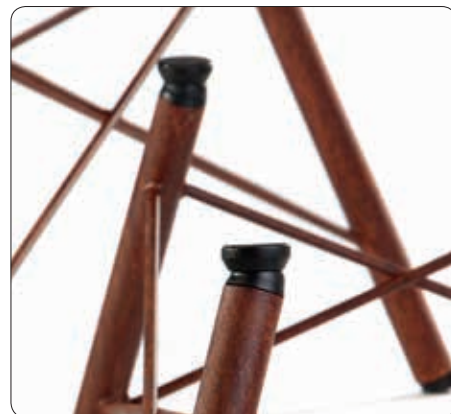

buffet stand “Crossline” - rust
steel, rusted surface, transparent sealing, square, hinged beams on top

item	l x w x h in cm	l x w in cm (on top)
8320.15R	41.5x41.5x15.5	34x34
8320.31R	49.5x49.5x31	34x34

Filigree understatement!

The filigree displays of the “Crossline” series feature an enormous stability due to their cleverly elaborated statics. These elements, which have been deliberately designed to have a plain and restrained appearance, unobtrusively blend into every ambience.

The rectangular base has been constructed especially for a presentation bowl made of dark grey glass, which impresses by its length of 130 cm. Hinged beams at the upper side of the trestle can be adjusted to the shape of the bowl individually. Hence also Zieher buffet platters of 80 cm x 40 cm and bigger can be installed. The supports are felt-covered, which minimises disturbing noise, evens out smaller asperities and provides for slip-resistance. Two more versions in square shape are constructed identically and are suitable for instance for buffet platters of the sizes 42 cm x 42 cm or 50 cm x 50 cm.

All trestles are made of galvanised steel and afterwards coated with a robust and scratch-proof powder-coating in a classy matt black. Therefore the stands are also suitable for outdoor areas. A second variant of raw steel with a rusted and sealed surface inspires by the charm of corroded metal and perfectly matches the industrial style of modern architecture! Low weight, space-saving storage due to its stackability, easy handling and quick installation are just a few advantages of the “Crossline” series. The matt black colouring of the stands can be combined harmoniously with many different materials. Thanks to the large variety of Zieher buffet platters, the arrangement of buffets can be redesigned again and again.



The dark grey glass bowls are available on page 71, our complete range of buffet platters is available on pages 44 to 53.

“Skyline” - Manhattan-Feeling on the buffet



“Skyline”, Zieher’s buffet system, allows a maximum of flexibility for most exclusive buffet presentations. Different heights enable you to install big buffet platters on the one hand - on the other hand they can be stabilised by insertion into the corresponding serration. The square columns are made of highly-polished stainless steel and due to the standardised serration heights they can be combined with the “Squareline” (pages 20 to 23) and “Curve” series (pages 24 and 25).

The spectacular look, that brings the silhouette of skyscrapers to mind, is available in a highly polished version and for an intensified effect also in black and white colouring (gold and copper on request!). The optionally available Zieher LED-lights are a perfect addition to the system and come in 2 versions: cabled and rechargeable (pages 40 and 41). In combination with light-diffusing tubes (page 40), they provide a perfect illumination of the system in various colours.



Buffet platters made of grey glass are available on page 49, black glass trays and glass steps on page 53.

“Skyline” - the original!



The buffet platters are available on page 48.



"Skyline"- the original

Buffet platters made of glass, laminated plastic and slate are available from page 44 onwards.



The glass bowls item 5346 and 5308.26 are available on page 175.



The LED-lights, either as rechargeable or cable version, are available on pages 40 and 41.



acrylic glass tube

satined (white), removable lid for easy fitting of bowls etc., notch for cable for LED-light item 8104 (not included, please order separately)

item	Ø in cm	height in cm	PU
8122.10	12	10	3 tubes
8122.22	12	22	3 tubes
8122.34	12	34	3 tubes
8122.58	12	58	3 tubes



The displays of the series "Skyline" and many other items made of stainless steel can be refined to gold and copper versions. All information about refining of stainless steel in PVD process on page 76.

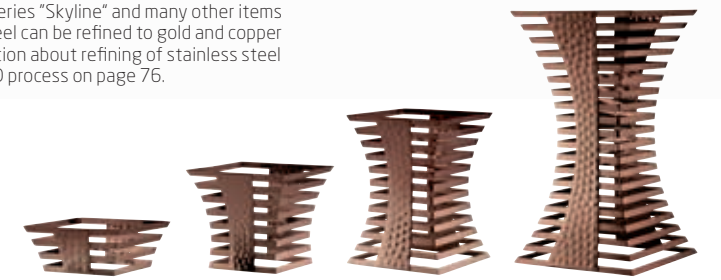

silicone sleeve

transparent, slotted lengthwise, for buffet stand "Skyline" items 8081..., 8082..., 8084... and buffet stand "Skyline" items 2177..., 8300... and 8305... (prevents the slipping of buffet platters)

item	length in mm	PU
4684	20	10 pcs



Storage and transportation trolley

We are happy to offer you an individual solution for the transportation and storage of your miscellaneous items. Please ask us!



buffet stand "Skyline"

massive stainless steel 18/10, matt black (powder-coated), square, not dishwasher-safe

item	l x w x h in cm
8300.10	25x25x10.5
8300.22	25x25x22.5
8300.34	25x25x34.5
8300.58	32x32x58.5

buffet stand "Skyline"

massive stainless steel 18/10, white (powder-coated), square, not dishwasher-safe

item	l x w x h in cm
8305.10	25x25x10.5
8305.22	25x25x22.5
8305.34	25x25x34.5
8305.58	32x32x58.5

buffet stand "Skyline"

massive stainless steel 18/10, highly polished, square, dishwasher-safe, food-safe

item	l x w x h in cm
2177.10	25x25x10.5
2177.22	25x25x22.5
2177.34	25x25x34.5
2177.58	32x32x58.5

"Skyline"



Please note: The bread baskets from the "Skyline" series have a closed base plate and rubber feet. They deviate in height from the buffet stands items 2177...



insert f. wine cooler item 8202
acrylic glass, with 4 holes, suitable for decanters or bottles up to a diameter of 10.5 cm

item	version	l x w in cm
8203.02	transparent	33.5x33.5
8204.02	satined	33.5x33.5

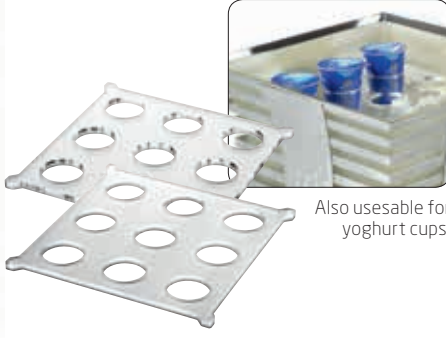

insert f. wine cooler item 8202
acrylic glass, with 9 holes, suitable for glass bottle with swing top item 5290.02 or for standard juice glasses/ bottles up to a diameter of 5.8 cm

item	version	l x w in cm
8203.01	transparent	31.4x31.4
8204.01	satined	31.4x31.4

For the illumination of item 8202, we recommend the use of 2 - 3 LED-lights.

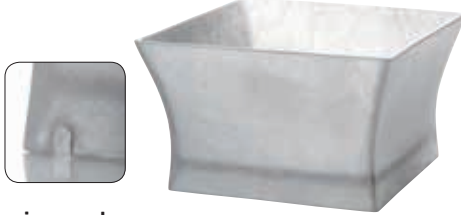

wine cooler
fibreglass natural, with raised bottom and notch for cable on the backside to place an LED-light below the cooler, to be used as an insert for bread basket "Skyline" item 2178.23

item	l x w x h in cm	content in l
8202	37x37x22	16.0

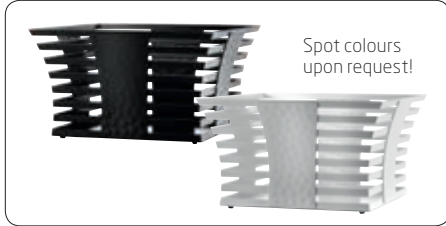

Spot colours upon request!



fruit/bread basket "Skyline"
massive stainless steel 18/10, highly polished, square, with bottom plate and 4 rubber feet

item	l x w x h in cm
2178.23	40x40x23.5

"Skyline"

glass carafe
clear glass

item	Ø in cm	height in cm	content in l
5352	9	31	1.0



glass bottle
clear glass, with swing top (PVC lid), height incl. swing top

item	Ø / height in cm	content in l	PU
5290.02	5.5 / 19	0.2	12 pcs



satined insert



transparent insert

The inserts are available in two versions with frosted and transparent surface finish. They prevent the shifting and leaking of carafes and glasses in ice and keep the buffet constantly in good order.

"Skyline" made by Zieher - Compare the original to copies of inferior quality!

Reasons to stick with the original:

- Different versions: polished, matt black and white (golden and copper on request)
- Highest Zieher quality and perfect accuracy in manufacturing
- Compatibility with other Zieher items
- 100 % fitting illumination
- Massive stainless steel 18/10
- Design by Zieher in 2009



The "Skyline" buffet system allows a maximum of flexibility for most exclusive buffet presentations.

Due to the same serration heights, the "Skyline" system is combinable with our "Squareline" system (pages 20 to 23) and "Curve" (pages 24 and 25). The different adaptors of the "Squareline" system may equally be used with the "Skyline" stands (exception: columns with 58 cm height).

Please note: Due to constructional reasons the combination of "Skyline" with the walnut adaptor (item 4736) can only be illuminated with limitations.

Some exemplary displays can be seen here:



"Skyline" black, connector pieces acrylic glass satined (page 22), platters grey glass (page 49), acrylic glass tubes (page 16), rechargeable LED-lights (page 41).

"Skyline" white, walnut connector piece (page 22), walnut tray (page 112).

"Skyline" highly polished, connector pieces acrylic glass black (page 22), platters black glass (page 50), acrylic glass tubes (page 16), rechargeable LED-lights (page 41).

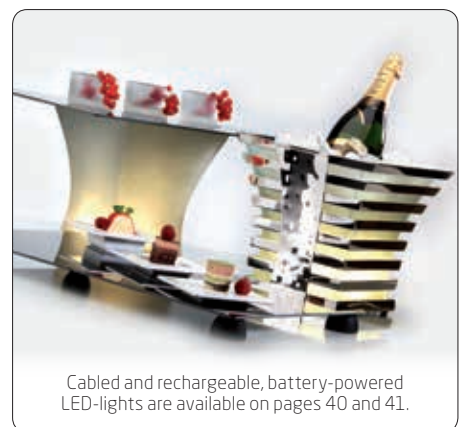

Cabled and rechargeable, battery-powered LED-lights are available on pages 40 and 41.



The bowl "Sixth Sense" is available on page 78.



fruit/bread basket "Skyline"
massive stainless steel 18/10, highly polished, square, with bottom plate and 4 rubber feet

item	l x w x h in cm
2179.10	25x25x11.5
2179.22	25x25x23.5
2179.34	25x25x35.5

"Squareline"



"Squareline" black, acrylic connector pieces satined (page 22), glass platters grey (page 49), "Lightning Buffet" tubes (page 40), rechargeable LED-lights (page 41).



"Squareline" polished, connector pieces walnut (page 22), buffet platters made of glass (page 48-52), trays "Solid" walnut (page 112), glass steps transparent (page 53).



"Squareline" black, acrylic connector pieces black (page 22), glass platters black (page 50), glass steps black (page 53).



"Squareline", the buffet system with 1000 faces!



"Squareline" white, acrylic connector pieces black (page 22), glass platters black (page 50), glass steps black and glass trays black (page 53).

Our classic "Skyline" has been changed and advanced to become "Squareline", which now offers several new features apart from its pure design.

The stainless steel displays are available in two heights. Three versions, highly polished, matt black and white (golden and copper on request), grant the columns completely different effects! The "Squareline" towers can be stacked on top of each other by using connector pieces which are available in three different versions. A 90° rotated arrangement of the stands increases the creative leeway tremendously and permits a buffet set-up at an angle.

Besides the technical aspect, the connector pieces are mainly a decorative element. They are available in glossy black as well as in satined, light-diffusing acrylic. The third version is handmade from solid walnut in best quality. In connection with the various displays and buffet platters countless possibilities for the creation of a buffet arise.

Optionally "Squareline" offers the possibility of a 100 % integration of our "Lightning Buffet" – the full height of the columns will be illuminated from the inside. When using the satined connector pieces, their light-diffusing effect even enhances the spectacular sight. The system is based on the buffet classic "Skyline" (pages 14 to 19), both in construction and in form. So both systems can be combined quite easily.

Just let your imagination run wild!



"Squareline"



silicone sleeve
transparent, slotted lengthwise, for buffet stand "Squareline" items 8081..., 8082..., 8084... and buffet stand "Skyline" items 2177..., 8300... and 8305... (prevents the slipping of buffet platters)

item	length in mm	PU
4684	20	10 pcs

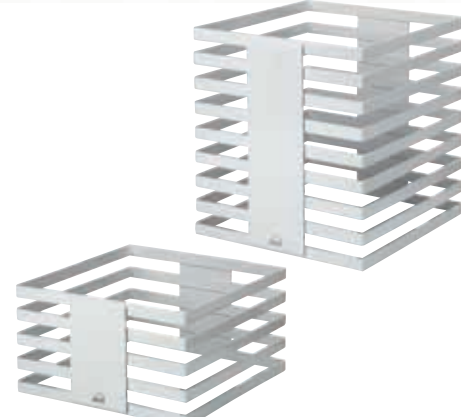

buffet stand "Squareline"
massive stainless steel 18/10, highly polished, square, dishwasher-safe, food-safe

item	l x w x h in cm
8081.13	24x24x13.5
8081.25	24x24x25.5

buffet stand "Squareline"
massive stainless steel 18/10, white (powder-coated), square, not dishwasher-safe

item	l x w x h in cm
8084.13	24x24x13.5
8084.25	24x24x25.5

buffet stand "Squareline"
massive stainless steel 18/10, matt black (powder-coated), square, not dishwasher-safe

item	l x w x h in cm
8082.13	24x24x13.5
8082.25	24x24x25.5

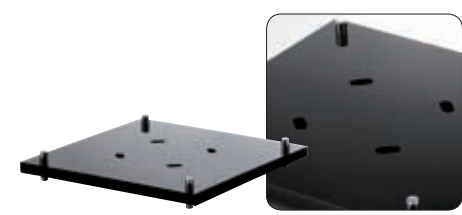
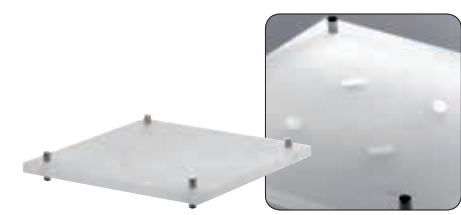
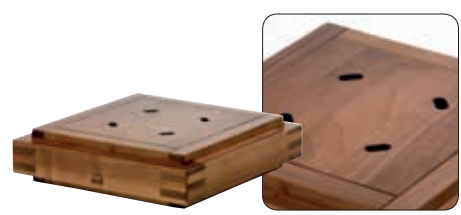

acrylic connector "Squareline"
clear satined (translucent), with 4 stainless steel pins and 4 holes for cable run

item	l x w x h in cm
8083.01	27x27x3.5

acrylic connector "Squareline"
black, glossy, with 4 stainless steel pins and 4 holes for cable run

item	l x w x h in cm
8083.02	27x27x3.5

walnut connector "Squareline"
food-safe sealed, not dishwasher-safe, with 4 holes for cable run

item	l x w x h in cm
4736	27x27x7

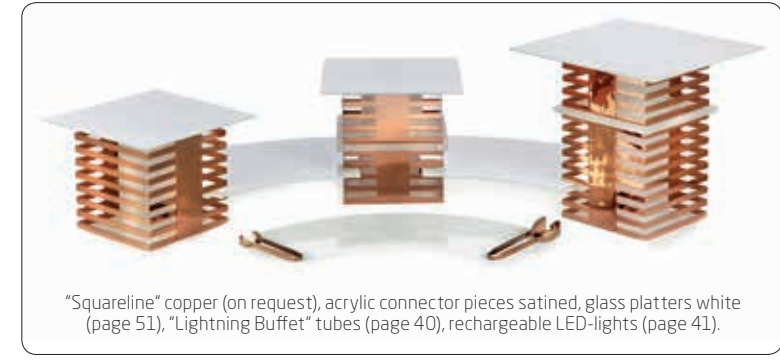

"Squareline" copper (on request), acrylic connector pieces satined, glass platters white (page 51), "Lightning Buffet" tubes (page 40), rechargeable LED-lights (page 41).

"Squareline"

No matter whether it is classic design in stainless steel with wood, golden and copper, or the highly modern design in matt black and white with stunning lighting – "Squareline" will adapt to every atmosphere and will give your guests lasting impressions!



The rechargeable LED-light (item 8150, optionally available, page 41) offers numerous fixedly pre-installed colours as well as special programs like colour gradient and flickering-candle-effect. The compatible remote control (item 8151) allows the synchronization of up to 20 LED-lights at the same time and enables the change of the complete buffet-colouring by just pressing one button! Alternatively and especially for fixed buffet installations we recommend the use of the Zieher LED-lights with cable (item 8104, page 40). With this item, 5 lighting colours can be set by using stick-on colour-filters.

The connector pieces feature slots for the cables, so that the cables can be laid invisibly through the columns of the "Lightning Buffet". To do this, the detachable lids of the acrylic tubes have to be removed. If cabled LED-lights are used, it is recommended to lay down all components of a "Squareline"- tower next to each other on the table to facilitate the installation of the cables.

Please note: To illuminate the system you will need one LED-light and one acrylic column in the fitting size (12 resp. 24 cm) for each "Squareline" stand. The acrylic columns are available in sets of 3 pieces (items 8120...) and can be found on page 40, the information on our LED-lights can be found on pages 40 and 41.



"Squareline" polished, acrylic connector pieces satined, platters transparent glass (page 52), buffet platter (page 72) and glass steps transparent (page 53), "Lightning Buffet" tubes (page 40), rechargeable LED-lights (page 41).



"Curve" - flexibility with a concept

"Curve" is made of 3 mm strong galvanised steel with a high grade powder coating. This guarantees great stability and corrosion-resistance. The colouring in matt black or white as well as the gaps between the bars were expressly chosen by the Milanese designer Itamar Harari to make the raisers completely compatible with the systems "Skyline" (pages 14 to 19) and "Squareline" (pages 20 to 23). The attractively priced "Curve" is therefore not only suitable as a starter version but also as an optimal extension of existing systems.

During the development of "Curve", special attention was given to the mobile usage. Thus all components can be stored in an extremely space-saving way. Simple and swift to install, "Curve" is the perfect equipment for outdoor areas, events and catering.

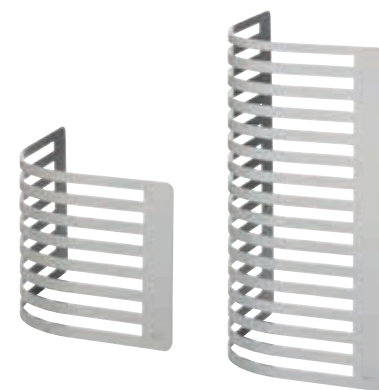

buffet stand "Curve"
galvanised steel, 3 mm thick, white (powder-coated), not dishwasher-safe

item	l x w x h in cm	PU
8311.22	27x27x22.5	2 pcs
8311.46	27x27x46.5	2 pcs

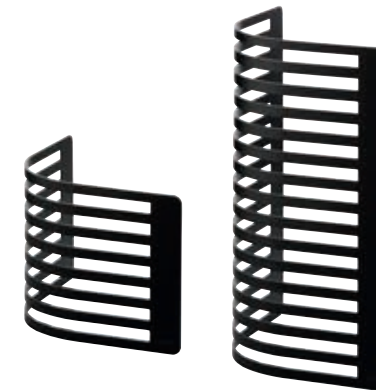

buffet stand "Curve"
galvanised steel, 3 mm thick, matt black (powder-coated), not dishwasher-safe

item	l x w x h in cm	PU
8310.22	27x27x22.5	2 pcs
8310.46	27x27x46.5	2 pcs



The "Zieher-System"

Zieher offers innumerable possibilities to present food optically appealing and highly flexible. When developing new buffet products it is most important for Zieher to guarantee compatibility among the individual systems.

The "Zieher-System" with its different heights of 12, 24 and 36 cm or 8, 16, and 24 cm leads to a perfect composition of different presentation levels on the buffet, thus offering more flexibility in the arrangement of a buffet. A wide range of buffet platters and trays of hardened glass, natural slate and laminated plastic in various styles are available on pages 44 to 53.

Thanks to the boundless possibilities, varying materials and designs, every buffet can easily be adapted to any accommodation. The system becomes part of the whole interior and assimilates harmonically into any ambience.

"Konkret!"



"Konkret!" (from page 27 on)

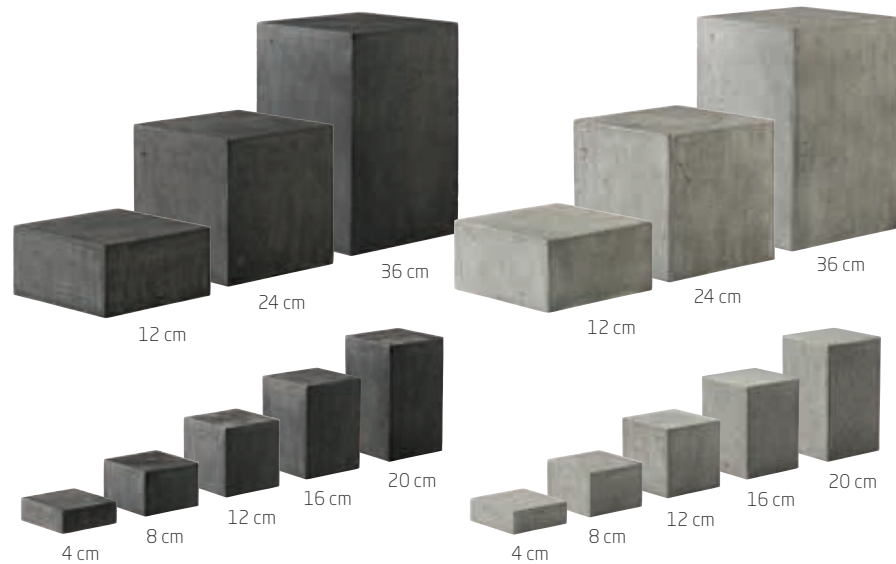

"Basic" (from page 34 on)



"Solid" (page 38)



"Antique" (page 38)



"V12" - Carbon (from page 32 on)

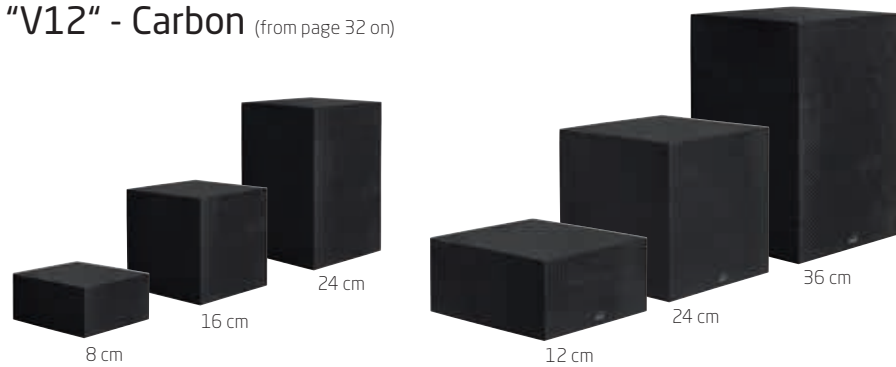

"Lightning Buffet" (from page 39 on)



"Classy" (from page 36 on)

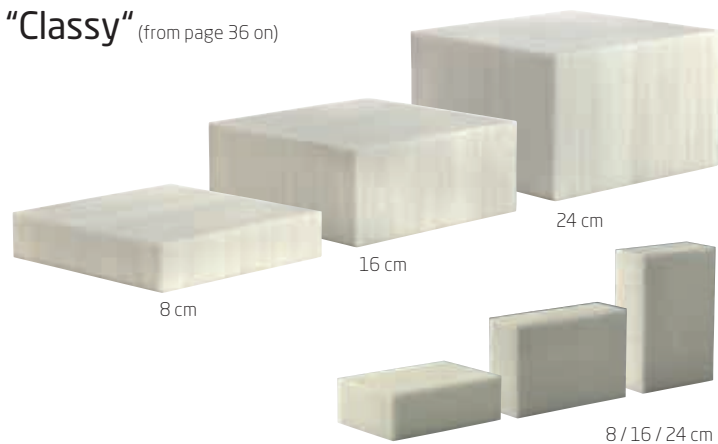

"Luxor" (from page 30 on)

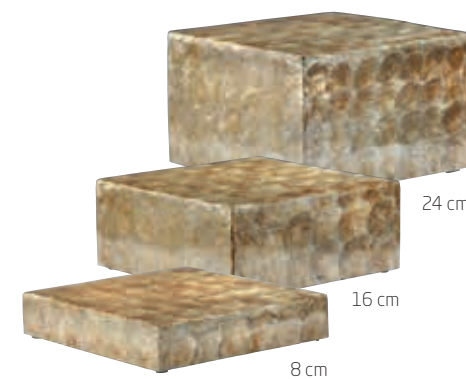

"Konkret!" - Distinct design for highest flexibility!

Plain lines, neutral shapes and two different colour variations put your food presentation into focus and offer a maximum of flexibility while at the same time using the available space at your buffet most effectively. Maximum reduced shapes in combination with the rough look of concrete - "Konkret!" blends in particularly well with modern architecture. "Less is more" is the motto!

Both variants of the displays (light grey and dark grey) are available in eight sizes.

A real eye-catcher is the double-walled XXL bowl in dark grey colour. The impressive diameter of 100 cm creates space for various drinks or chilled dishes (page 28).



The displays consist of a mixture of fibre-glass and stone and therefore offer the deceptively genuine optics of concrete combined with low weight and high stability which greatly facilitates handling. The puristic flair of that system will be intensified by using glass platters. Those and other variations made of laminated plastic and slate are available on pages 44 to 53.



The XXL bowl "Konkret!" is available on page 28.

"Konkret!"



buffet display "Konkret!"

fibreglass/resin, dark grey (concrete look), not dishwasher-safe, splash-proof, hollow inside, bottom side open

item	l x w x h in cm
8200.12D	24x24x12
8200.24D	24x24x24
8200.36D	24x24x36



buffet display "Konkret!"

fibreglass/resin, dark grey (concrete look), not dishwasher-safe, splash-proof, hollow inside, bottom side open

item	l x w x h in cm	PU
8210.04D	12x12x4	2 pcs
8210.08D	12x12x8	2 pcs
8210.12D	12x12x12	2 pcs
8210.16D	12x12x16	2 pcs
8210.20D	12x12x20	2 pcs



buffet display "Konkret!"

fibreglass/resin, light grey (concrete look), not dishwasher-safe, splash-proof, hollow inside, bottom side open

item	l x w x h in cm
8200.12L	24x24x12
8200.24L	24x24x24
8200.36L	24x24x36



buffet display "Konkret!"

fibreglass/resin, light grey (concrete look), not dishwasher-safe, splash-proof, hollow inside, bottom side open

item	l x w x h in cm	PU
8210.04L	12x12x4	2 pcs
8210.08L	12x12x8	2 pcs
8210.12L	12x12x12	2 pcs
8210.16L	12x12x16	2 pcs
8210.20L	12x12x20	2 pcs



"Konkret!"



XXL bowl "Konkret!"

fibreglass/resin, dark grey (concrete look), round, double-walled, not dishwasher-safe, waterproof-coated inside

item	Ø in cm	height in cm
8212.D	100	28

The separating plate is kept in position by a bearing edge integrated in the bowl.

The rechargeable LED-light item 8150 is available on page 41.



buffet platter/separating plate

hardened glass, 10 mm thick, satined, round, edge polished and deburred, separates ice and melt water

item	Ø in cm
5240.M	60



rack for XXL bowl "Konkret!"

galvanised steel, matt black (powder-coated), three-part for self assembly, adjustable feet for firm positioning on most surfaces, for XXL bowl "Konkret!" item 8212.D

item	l x w x h in cm
8213	70x70x57



hand pump

highly elastic PVC, 2.5 mm thick, with hose, for easy drainage of melt water, professional quality, vacuum capacity: 10 l/min

item	Ø hose in cm	total length hose in cm
5662	2	250

Buffet bowls made of grey glass are available on pages 68 to 71.



Buffet platters made of glass are available from page 48 on, the candle holder “Stele” on page 281.



The glass tubes of the “Flex” series are available on page 206.



buffet display “Luxor”

high-quality shell imitation, golden, washable, bottom side open, with 4 resin feet, not dishwasher-safe

item	l x w x h in cm
8221.08	38x38x8
8221.16	38x38x16
8221.24	38x38x24

The shimmering displays of the “Luxor” series enchant by the play of colours of golden shades in variable nuances. This effect is created by high-quality shell imitations, which are arranged fan-shaped on a fibreglass base in sophisticated handcrafting. The honed and highly polished multiple sealing with resin (Polyresin), emphasizes the pattern and the pearlescent shine of the gold-coloured discs and provides the surface with a striking depth effect.

The buffet cuboids are available in heights of 8, 16 and 24 cm and are therefore compatible with many other displays of the Zieher system. The 38 cm x 38 cm large bearing surface can be used directly for presentation purposes or as a basis for buffet platters or stairs of various kinds.

“Luxor” adds a touch of extravagance to both the modern and classic ambience, setting extraordinary accents in any environment.





buffet display "V12"
carbon fibre (fabric), high-gloss, black, not dishwasher-safe, splash-proof, bottom side closed

item	l x w x h in cm
8206.08	20x20x8
8206.16	20x20x16
8206.24	20x20x24



buffet display "V12"
carbon fibre (fabric), high-gloss, black, not dishwasher-safe, splash-proof, bottom side closed

item	l x w x h in cm
8205.12	24x24x12
8205.24	24x24x24
8205.36	24x24x36

"V12" combines modern and reduced forms with the precious material carbon. The elegant and three-dimensional look of the carbon fibre paired with maximum stability - "V12" adds high-tech to the buffet!

In connection with the huge Zieher assortment of buffet platters, "V12" provides a maximum in flexibility and best usage of buffet surfaces. Six different sizes of the "V12" displays offer a lot of possibilities for the individual composition of your buffet.

The standard height of the carbon buffet displays of 12, 24 and 36 cm resp. 8, 16 and 24 cm permits an easy and simple combination with other Zieher systems. For an overview please consult page 26.



The buffet stands "Basic" are available on page 32, the cloches on pages 177 to 185.





The card holder made of stainless steel is available on page 96.

Food: Pâtisserie Walter (www.patisserie.de)



buffet stand “Basic”

stainless steel 18/10 brushed (pipe Ø 3.2 cm), with felt pad at the top (black)

item	Ø in cm	height in cm	PU
8080.04	7	4	2 pcs
8080.08	7	8	2 pcs
8080.16	7	16	2 pcs
8080.24	7	24	2 pcs



“Basic” & “Konkret”

“Basic” is the simple and flexible solution to create different presentation levels. The high-quality columns made of matt brushed stainless steel (18/10) are a fitting base for buffet platters made of glass and other materials. The columns are fitted with felt pads on the top to protect the surface of glass platters and to level out any unevenness of the tables. The feet with 7 cm in diameter guarantee firm standing. The unobtrusive and unadorned design of the buffet stands puts the food and drinks in the limelight.

“Basic” is available in four heights and can be combined with several Zieher buffet systems (pages 26). The carbon buffet stands “V12” presented here can be found on pages 32 to 33.

Please note: We do not recommend the use of “Basic” in combination with buffet platters made of natural slate. Due to the slightly varying thickness of natural slate platters, this combination might shake.

“Basic” & “V12” Carbon



The buffet displays “Classy” are made of translucent material and impress by their fascinating texture that is reminiscent of Italian marble or alabaster. The precise workmanship of the cubes as well as the silk-matt surface increase the fancy impression even more.

“Classy” is available in the Zieher system heights of 8, 16 and 24 cm and can therefore be combined in various ways. The open bottom side of the large displays allows an effective illumination by the optionally available LED-lights. With their different light colours, the LED-lights emphasize the appealing look and the interesting marbling of the material.

The small cube has no open underside and thus cannot be illuminated. The advantage of this construction lies in its high functionality. Its dimensions of 24 cm x 16 cm x 8 cm enable a positioning in 3 heights - a clever supplement to the squarish displays.



It is possible to stage “Classy” with or without lighting, strikingly eye-catching or quite discreetly. Whether unobtrusive and modern or playful and opulent – “Classy” fits perfectly into any ambience!

The LED-lights are available on pages 40 and 41.



The baskets of the “Reef” series are available on pages 62 to 64.



Closed on all sides, cannot be illuminated.



Notch for cable for LED-light item 8104



buffet display “Classy”

resin, white, translucent, alabaster look, not dishwasher-safe, bottom side open, notch for cable on back side

item	l x w x h in cm
8230.08	38x38x8
8230.16	38x38x16
8230.24	38x38x24



buffet display “Classy”

resin, white, translucent, alabaster look, not dishwasher-safe, closed on all sides, can be used in any position

item	l x w x h in cm
8231	24x16x8





"Solid"

The buffet displays of the "Solid" series are made of solid walnut wood, like all the other items of this series. They may be used as containers for cutlery or French bread, but they are particularly suitable for the elevation of the "Modul" walnut trays (page 132) or other buffet platters.

The filigree finger joints at the corners testify to precise craftsmanship of the highest quality and guarantee perfect stability!

The displays made of solid wood are visually appealing and fit perfectly into the existing buffet systems "Solid" and "Mercato" (pages 102 to 117).



Please note the care instructions:
not dishwasher-safe, do not immerse in water!



buffet display "Solid"

walnut, food-safe sealed, not dishwasher-safe, bottom side open, can be used as a stand or as a container

item	l x w x h in cm	PU
4767.12	12x12x12	2 pcs
4767.24	12x12x24	2 pcs



"Antique"

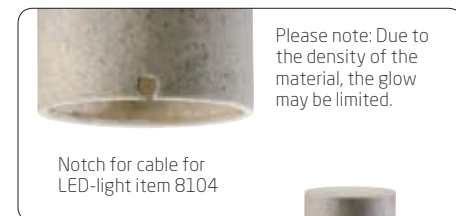

Please note: Due to the density of the material, the glow may be limited.

Notch for cable for LED-light item 8104



buffet stand "Antique"

polyresin sandstone mixture, sandy colour, hollow inside, notch for cable on back side

item	Ø in cm	height in cm
8011.12	12.5	12
8011.24	12.5	24
8011.36	12.5	36

"Lightning Buffet"

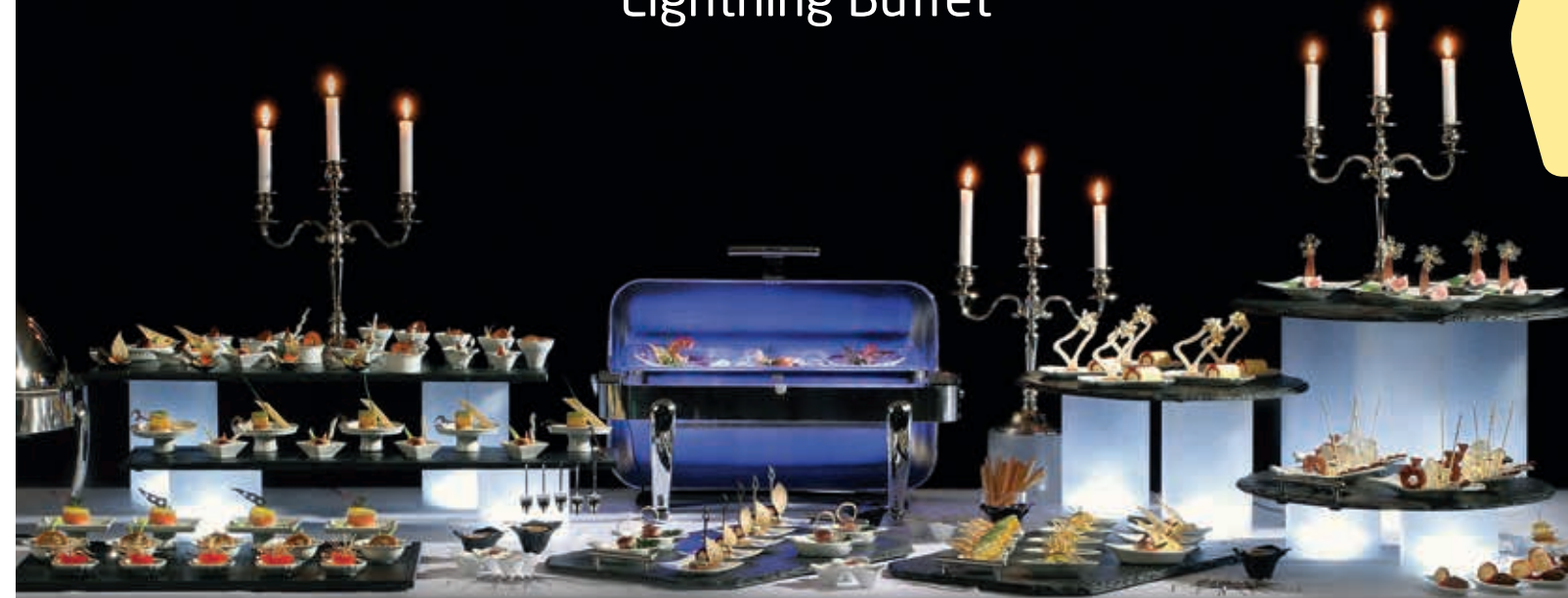

Bringing light into the darkness!

The illuminated buffet stands in connection with platters made of natural slate, laminated plastic or glass (pages 44 to 52) make every buffet shine in a radiant new light.

The innovative LED technology does not radiate any heat and is powered by a harmless voltage. It is characterized by its longevity and its low power consumption. The standard light of the cabled LED is white, but thanks to the coloured plastic covers, the colour scale is enlarged to contain red, yellow, green and blue (page 40).

Alternatively there is a rechargeable LED-light with several different functions available. Besides a fixed colour range and special programs, its particular feature is a remote control that enables the changing of colours and programs while in use. For a detailed description of this LED-light and its functions please check out page 41.

The columns made of satined acrylic (page 40) are available in seven sizes and feature a removable cover to enable the insertion of round bowls.





The height of the columns items 8122... has been adjusted especially for the illumination of the "Skyline" buffet system. The lids of all acrylic glass tubes are removable. Therefore the tubes can also function as supports for plates, bowls, etc.



acrylic glass tube

satinated (white), removable lid for easy fitting of bowls etc., notch for cable for LED-light item 8104 (not included, please order separately)

item	Ø in cm	height in cm	PU
8122.10	12	10	3 tubes
8122.22	12	22	3 tubes
8122.34	12	34	3 tubes
8122.58	12	58	3 tubes



acrylic glass tube

satinated, white, removable lid for easy fitting of bowls etc., notch for cable for LED-light item 8104 (not included in delivery, please order separately)

item	Ø in cm	height in cm	PU
8120.01	15	12	3 tubes
8120.02	15	24	3 tubes
8120.03	15	36	3 tubes

LED-light with cable, item 8104...



For permanently installed buffets which are not dismantled on a daily basis, it is recommended to use the LED-light with cable item 8104.

The standard light is white; the alternative colours blue, yellow, green and red can be chosen by using the precisely fitting plastic covers items 8105... (available as accessories).

A set consists of 3 lights and the matching power supply, which can be fitted with a total of 6 lights. All cables are white and the power cable of the light has a length of 3 metres, which is enough to stow away adapter and power supply safely and invisibly under the buffet table.



LED-light

white light, set of 3 LED-lights including power supply (cable), sixfold junction for up to 6 lights, 100-240 V, 50/60 Hz, Ø 9.7 cm, 2 cm high

item	power plug
8104	Europe
8104.UK	UK
8104.USA	USA

Please note: The luminosity depends on the spatial realities; the actual colouring may deviate from the colours shown in the pictures!



colour cover

plastic, for LED-light items 8104..., Ø 10 cm

item	colour	PU
8105.01	blue	3 pcs
8105.02	yellow	3 pcs
8105.03	green	3 pcs
8105.04	red	3 pcs

Rechargeable LED-light with radio remote control

The compact LED-light is controlled by remote control, which allows for a more flexible use of the Zieher "Lightning Buffet" and renders it independent from any power supply and spatial requirement.

This creates a lot of new possibilities for the buffet set-up: out in the open, next to the pool or in the middle of the room - without any troublesome cables and controllers that might get into the guests' or the personnel's way.

The necessary radio remote control item 8151 (to be ordered separately) rounds off the whole system in regard to function and handling and allows to choose the colouring within a range of up to 15 m without dismantling the buffet first. Due to many different colours and special programs, the buffet will fit into every kind of atmosphere. The lighting colour for the complete buffet can be changed by pressing only one button.

- 7 fixed colours and 3 special programs, manageable via remote control (white, green, red, blue, yellow, violet, turquoise, flickering-candle-effect, colour change, colour gradient)
- 3 different brightness-settings selectable (100% - 70% - 50%, only adjustable directly on the LED-light)
- Fixedly integrated high-end batteries guarantee a running-time of up to 20 hrs (at the lowest brightness-setting)
- LED-light waterproof up to a depth of 1 mtr.
- Remote control (to be ordered separately) controls up to 20 LED-lights simultaneously / range up to 15 m
- Charging device can be mounted on a wall and features a space-saving cable spool



Waterproof up to a depth of 1 metre!



Experience the "Lightning Buffet" - no matter where - you will be excited!



rechargeable LED-light

remote-controlled, 3 different degrees of brightness (only selectable on the light directly), 7 fixed colours (white, green, red, blue, yellow, violet, turquoise) and additionally: candle flickering, colour gradient and colour change (only selectable by remote control item 8151, please order separately)

item	Ø in cm	height in cm
8150	9.5	3



remote control

for rechargeable LED-light item 8150, white with grey cord

item	l x w x h in cm
8151	8.5x5.2x2.8



charging device for rechargeable LED-light

white, with handy cable spool (1.5 m of cable), wall fixing possible, 3 anti-slip rubberfeet, Ø 13 cm, 2 cm high

item	power plug
8152.EU	Europe
8152.UK	UK
8152.US	USA

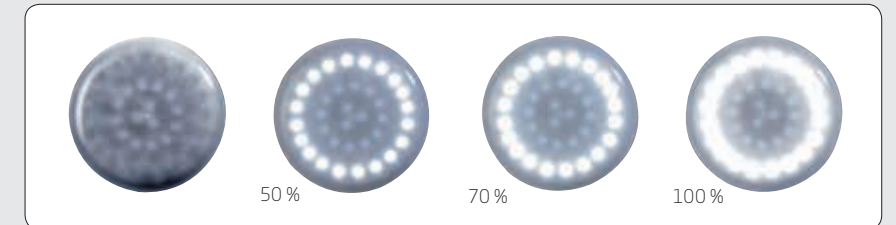

brightness-setting at the light

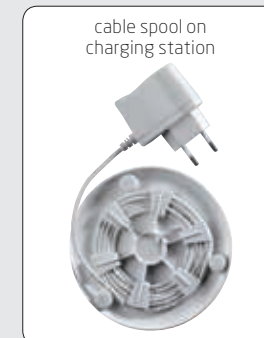

cable spool on charging station



recharging control light



The entire instruction sheet with a detailed description of all functions is available at https://www.zieher.com/fileadmin/ZieherUploads/Bedienungsanleitungen/Bedienungsanleitung_Akku_LED_Leuchte_8150.pdf

Please note: The luminosity depends on the spatial realities; the actual colouring may deviate from the colours shown in the pictures!





The „Textura“ buffet displays are available on page 6 / 7.



The porcelain bowl “Cave” is available on page 166.



cooling pack
nylon, black/white, non-toxic cooling gel

item	l x w in cm
5663.20	20x20



Precise recesses on the underside facilitate positioning!



chiller base/tray
melamine, matt, square, for cooling pack item 5663.20

item	colour	l x w x h in cm
4597.01	black	41x41x3,5
4597.02	white	41x41x3,5

“Chiller-Base” - just stay cool!

The cooling elements by Zieher are an elegant and simple solution for a quick and flexible installation of chilled platters. They can be arranged either at different heights by using displays or freely positioned on the buffet table.

The flat bowls are available in matt black and white melamine and have been designed specifically for food whose presentation can be extended significantly by cooling.

The puristic form, the compact height of only 35 mm as well as the restrained colouring allow a stylishly discreet integration into numerous buffet constructions. Tailored recesses on the underside of the trays facilitate symmetrical positioning on most Zieher buffet systems. So a harmonious overall picture can be achieved quickly. Unobtrusive rubber buffers in the corners of the “Chiller-Base” ensure a non-slip and secure fit of laid-up platters in sizes starting from 42 x 42 cm (page 48 - 52).

The cooling pads have been tailor-made for the melamine base to provide for an optimal cooling surface by the perfect fit. The pads can optionally be flipped, depending on whether the black top or the white bottom fits into the overall picture more harmoniously. So they are applicable inconspicuously even with slightly translucent or satined buffet platters.

The attractive contrast of top and bottom can also be used on the laid table to deliberately set accents. Serving chilled foods becomes a visual highlight. The high-quality case made of black or white nylon fabric looks very noble and yet discreet. It is filled with gel, which remains malleable even when frozen and thus allows an adaptation to a wide variety of tableware used.



“Skyline”, page 14 - 19



“Basic”, page 34 / 35



“Konkret!”, page 28 / 29



“Skyline”, page 14 - 19



“Squareline”, page 20 - 23

Buffet platters and more!

Zieher is offering a wide range of buffet platters made of laminated plastic, several kinds of glass and natural slate. Due to the wide choice of formats and types of materials, there are many possibilities of combinations with Zieher's buffet systems (pages 5 to 43). The offer is being completed by various buffet stairs, trays and bowls (pages 59 to 91).

Buffet platters made of slate!

- Natural slate
- Food-safe sealed/unsealed
- 10 to 15 mm thick
- With rubber feet



Natural slate, page 45

- Food-safe sealed/unsealed
- 10 - 15 mm thick
- With rubber feet

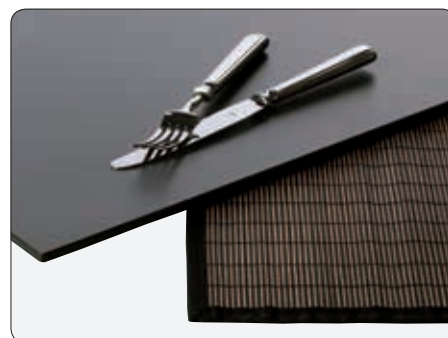

Laminated plastic, page 46

- Dark grey, black intermediate ply
- 8 mm thick
- Break-proof
- Dishwasher-safe
- Scratch-proof
- Antistatic



Laminated plastic, page 47

- Matured wood look, white or rusted look, black intermediate ply
- 8 mm thick
- Break-proof
- Dishwasher-safe
- Scratch-proof
- Antistatic

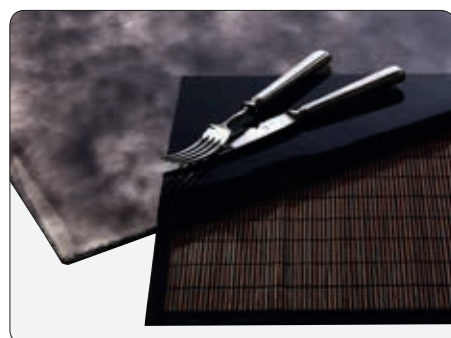

Structured glass, page 48

- Special hardened safety glass
- 5 or 8 mm thick (depending on size)
- Edges rounded
- Underside structured
- Irregular colouring in cloudy optic
- Dishwasher-safe



Dark grey glass, page 49

- Specially hardened safety glass
- 10 mm thick, transparent
- Edges polished and deburred
- Dishwasher-safe

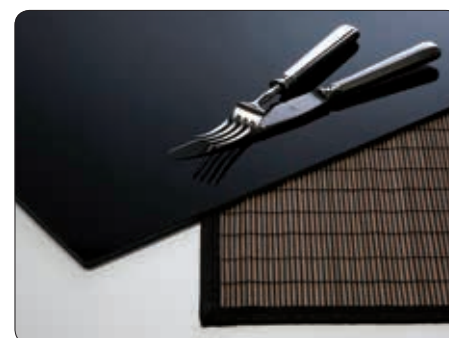

Black glass, page 50

- Specially hardened safety glass
- 4 mm thick, low weight
- Edges polished and rounded
- Underside scratch-resistant, black
- Shock-proof, heat-resistant
- Dishwasher-safe



White glass, page 51

- Special hardened safety glass
- 4 mm thick, low weight
- Edges rounded and polished
- Underside scratch-resistant, white
- Shock-proof, heat-resistant
- Dishwasher-safe

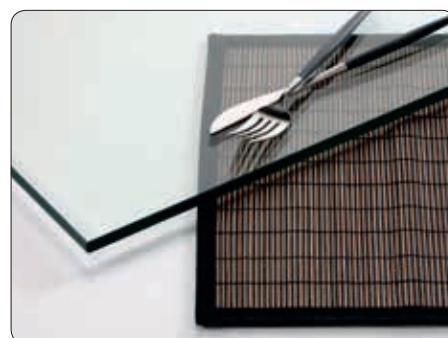

Transparent glass, page 52

- Specially hardened safety glass
- 10 mm thick
- Edges polished and deburred
- Dishwasher-safe

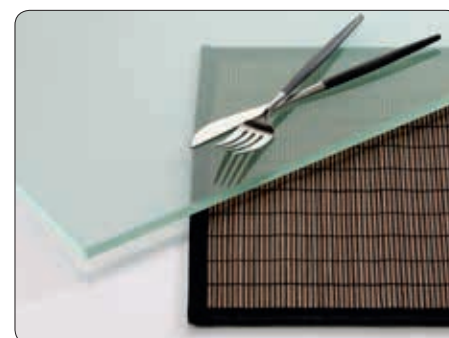

Satined glass, page 52

- Specially hardened safety glass
- 10 mm thick
- Edges polished and deburred
- Underside satined
- Dishwasher-safe



charger plate

natural slate, approx. 5 mm thick, food-safe (sealed), not dishwasher-safe, with rubber feet

item	version	l x w in cm
2543.30	square	30x30
2544.30	rectangular	30x20



buffet platter 1/1 GN, slate

natural slate, 10 to 15 mm thick, unsealed, not dishwasher-safe, rectangular, with rubber feet

item	l x w in cm
8020	53x32.5



buffet platter, slate

natural slate, 10 to 15 mm thick, food-safe (sealed), not dishwasher-safe, with rubber feet

item	version	l x w in cm
8005.01	square	50x50
8005.02	rectangular	50x42
8005.04	square	42x42
8005.05	rectangular	42x34
8005.06	square	34x34
8005.07	rectangular	60x40



buffet platter, slate

natural slate, 10 to 15 mm thick, food-safe (sealed), not dishwasher-safe, round, with rubber feet

item	Ø in cm
8005.21	60

Slate is a unique and exceptional natural product. The surfaces of our slate plates have the typical cleavage. Every piece is unique. Small deviations in structure, thickness (10 to 15 mm) and weight of the platters cannot be avoided because it is in the nature of the product. Also there could be single inclusions of other minerals and fossils. These exceptional features give slate its precious and vivid appearance. Please note: Specific groceries, especially those that contain fruit acid (citric acid) may damage the surface in case of longer contact. Therefore we recommend avoiding any direct contact with edibles.



Buffet platters made of laminated plastic!

- Dark grey, black intermediate ply
- 8 mm thick
- Break-proof
- Dishwasher-safe
- Scratch-proof, antistatic

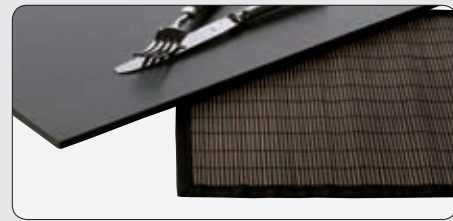

Buffet platters made of laminated plastic!

- Matured wood look, white / rusted look, black intermediate ply
- 8 mm thick
- Break-proof
- Dishwasher-safe
- Scratch-proof, antistatic



The "Amuse" series is available on pages 212 to 215.

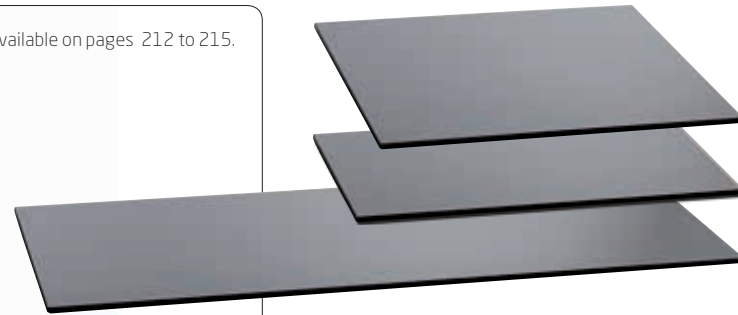

buffet platter, laminated plastic

laminated plastic, 8 mm thick, dark grey, black intermediate ply, break-proof, scratch-proof, dishwasher-safe, antistatic, deburred edges, rounded corners

item	version	l x w in cm
8006.01	square	50x50
8006.02	rectangular	50x42
8006.04	square	42x42
8006.06	square	34x34
8006.08	rectangular	80x21
8006.11	rectangular	53x32.5
8006.13	rectangular	95.4x39

"DressCoat" is available on pages 148 and 149.



buffet platter "Vintage"

laminated plastic, 8 mm thick, matured wood look, white, black intermediate ply, break-proof, scratch-proof, dishwasher-safe, antistatic, bevelled edges, rounded corners

item	version	l x w in cm
8001.01	square	50x50
8001.02	rectangular	50x42
8001.04	square	42x42
8001.06	square	34x34
8001.08	rectangular	80x21
8001.11	rectangular	53x32.5
8001.13	rectangular	95.4x39

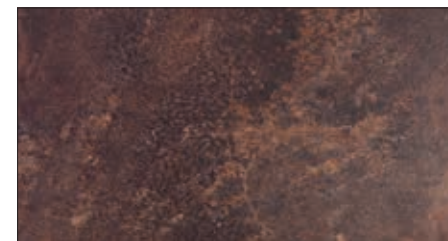

buffet platter "Industry 2.0"

laminated plastic, 8 mm thick, rusted look, black intermediate ply, break-proof, scratch-proof, dishwasher-safe, antistatic, deburred edges, rounded corners

item	version	l x w in cm
8007.01	square	50x50
8007.02	rectangular	50x42
8007.04	square	42x42
8007.06	square	34x34
8007.08	rectangular	80x21
8007.11	1/1 GN	53x32.5
8007.13	rectangular	95.4x39

The charm of the ephemeral

Break- and scratch-resistant, antistatic and dishwasher-safe - these features of laminated plastic platters and the resulting advantages are convincing!

The buffet platters made of laminated plastic are available in a neutral, dark grey version as well as in two extraordinary variations. The matured wood look, white "Vintage" decor is reminiscent of weathered and white discolored old wood planks. It emphasizes the radiance of imperfection and perfectly fits the furnishings of the attractive chalet style.

Unplastered brick-lined walls, load-bearing structural elements made of steel beams, exposed concrete and the morbid charms of abandoned factory buildings create the ambience for the rust-coloured decoration "Industry 2.0". This is evocative of weathered steel surfaces, which are marked by decades of corrosion.

All laminated buffet platters by Zieher have a dark middle layer and can be used on both sides due to having the decoration on both sides.

The buffet stands "Basic" are available on page 34, "Konkret!" on pages 27 to 29.



All information about the displays of the "Crossline" series can be found on pages 12/13.

Please note: With these decors each plate is unique, none of them look alike.

Buffet platters made of structured glass!

- Special hardened safety glass
- 5 or 8 mm thick (depending on size)
- Edges rounded, underside structured
- Irregular colouring in cloudy optic
- Dishwasher-safe



The creamer is available on page 216.

Each piece is unique!

The irregular colouring of the Zieher buffet platters is created by colour pigments which are manually applied and fused into the glass. The colour is fixed inside the glass and therefore dishwasher-safe and abrasion resistant. Structured underside and rounded edges emphasize the effect of the platters and the individual and interesting shades of grey and intensity of colour create unique patterns in each platter!

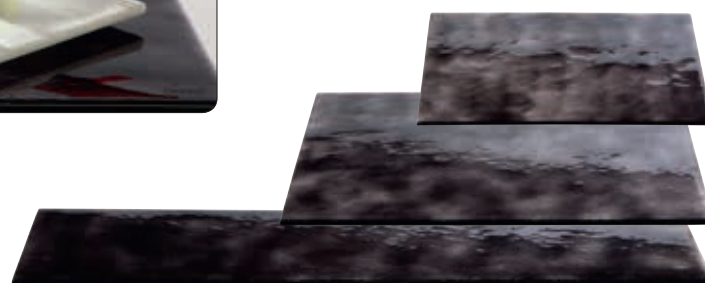

buffet platter, glass

hardened glass, grey transparent, irregularly coloured in a cloudy look, underside structured, dishwasher-safe, scratch-proof

item	version	l x w in cm	thickness in mm
8008.01	square	50x50	8
8008.02	rectangular	50x42	8
8008.03	rectangular	50x34	8
8008.04	square	42x42	5
8008.05	rectangular	42x34	5
8008.06	square	34x34	5
8008.07	2/1 GN	65x53	8
8008.08	rectangular	80x21	8
8008.13	rectangular	95.4x39	8

Buffet platters made of dark grey glass!

- Special hardened safety glass
- 10 mm thick
- Edges polished and deburred
- Dark grey, transparent
- Dishwasher-safe

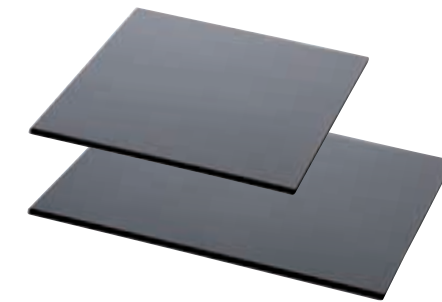
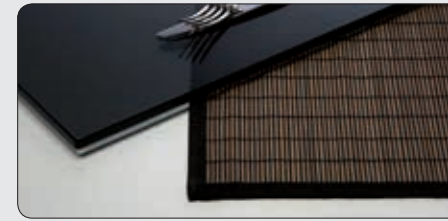

buffet platter, dark grey glass

hardened glass, 10 mm thick, dark grey, edges polished and deburred

item	version	l x w in cm
8004.01B	square	50x50
8004.02B	rectangular	50x42
8004.03B	rectangular	50x34
8004.04B	square	42x42
8004.05B	rectangular	42x34
8004.06B	square	34x34
8004.07B	2/1 GN	65x53
5243.B	rectangular	80x21
5000.B	rectangular	95.4x39

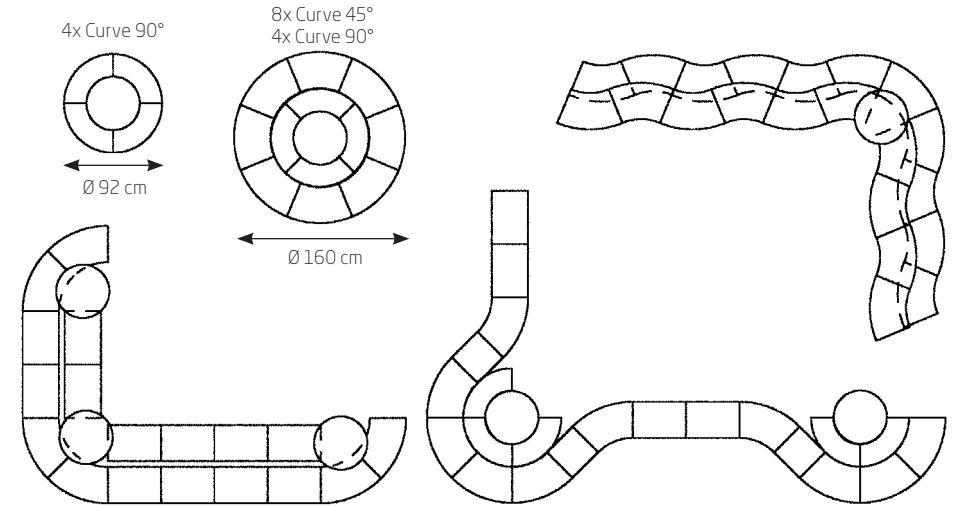

The curved platters combined with compatible buffet platters and buffet stands allow innumerable variations! These platters are available in transparent glass (page 52), black glass (page 50), white glass (page 51) and transparent dark grey glass (page 49).

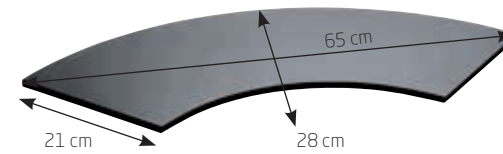

buffet platter Curve 90°

hardened glass, 10 mm thick, dark grey, curved shape, edges polished and deburred

item	l x w in cm	PU
5241.B	65x28	2 pcs

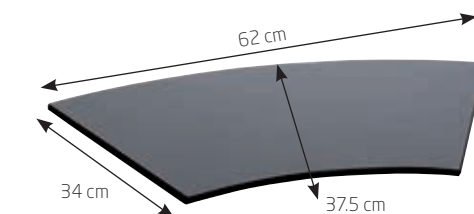

buffet platter Curve 45°

hardened glass, 10 mm thick, dark grey, curved shape, edges polished and deburred

item	l x w in cm
5242.B	62x37.5

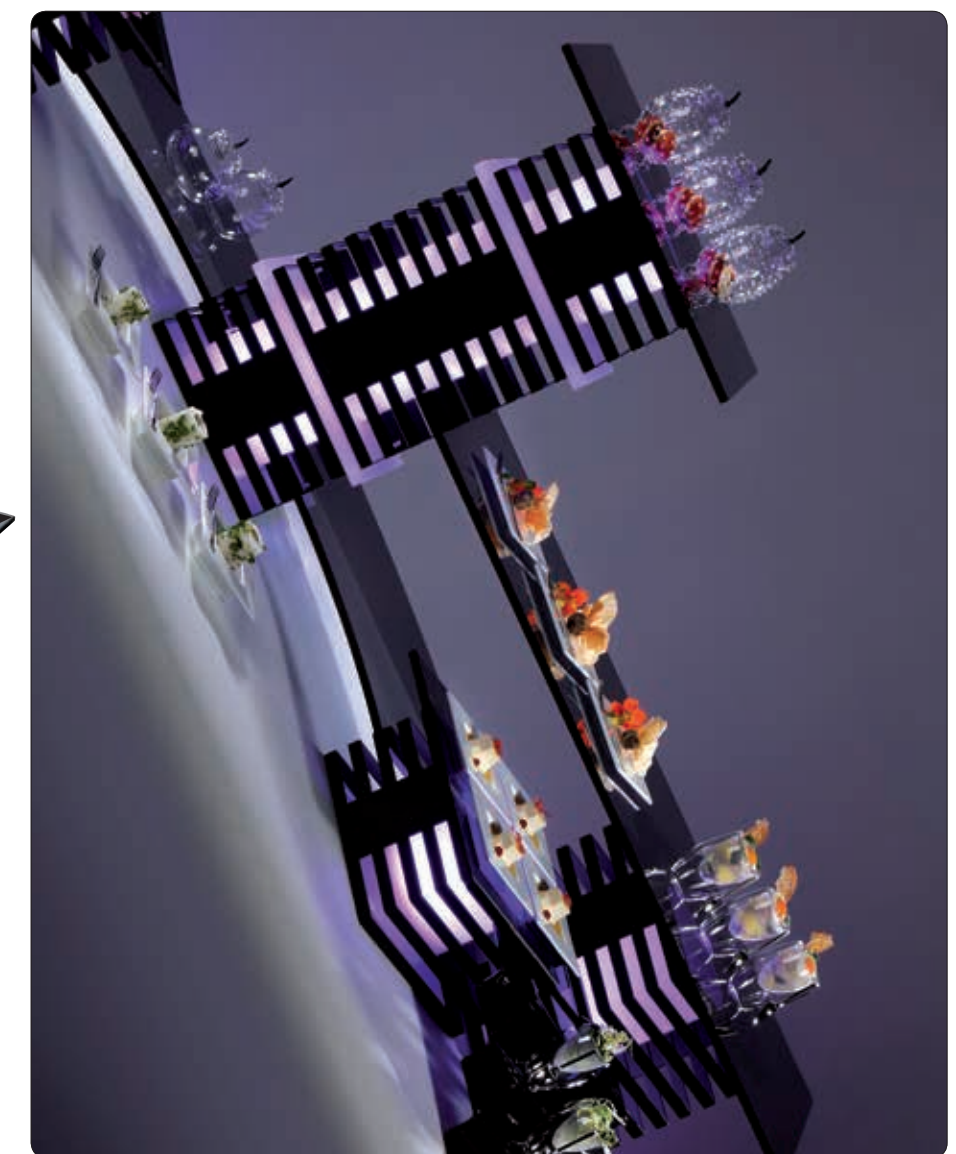

Buffet platters made of black glass!

- Special hardened safety glass
- 4 mm thick, low weight
- Edges rounded and polished
- Underside scratch-resistant, black
- Shock-proof, heat-resistant, dishwasher-safe



buffet platter, black glass

special hardened safety glass, 4 mm thick, rounded edges, polished rim, dishwasher-safe, rubber feet included (adhesive), underside scratch-proof

item	version	l x w in cm
1668.01	square	50x50
1668.03	rectangular	50x34
1668.04	square	42x42
1668.05	rectangular	42x34
1668.06	square	34x34
1668.08	rectangular	80x21
1668.09	rectangular	80x40
1668.10	rectangular	30x18
1668.12	rectangular	66x10

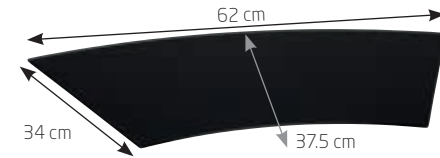

buffet platter Curve 45°

special hardened safety glass, 4 mm thick, curved shape, rounded edges, polished rim, dishwasher-safe, rubber feet included (adhesive), underside scratch-proof

item	l x w in cm	PU
1668.14	62x37.5	2 pcs

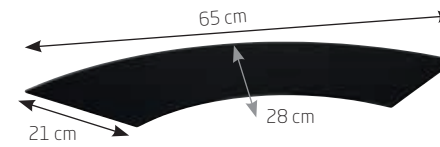

buffet platter Curve 90°

special hardened safety glass, 4 mm thick, curved shape, rounded edges, polished rim, dishwasher-safe, rubber feet included (adhesive), underside scratch-proof

item	l x w in cm	PU
1668.15	65x28	2 pcs



charger plate, black glass

special hardened safety glass, 4 mm thick, black, round, edge polished, dishwasher-safe, rubber feet included (adhesive), underside scratch-proof

item	Ø in cm
1669.33	33



buffet platter, black glass

special hardened safety glass, 4 mm thick, black, round, edge polished, dishwasher-safe, rubber feet included (adhesive), underside scratch-proof

item	Ø in cm
1669.53	53

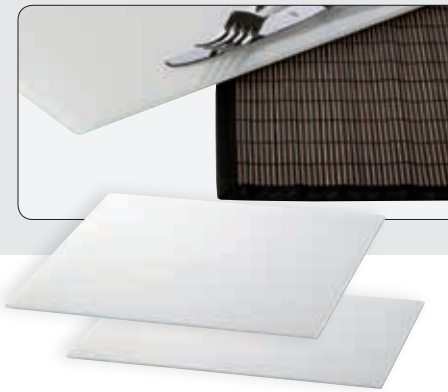

buffet platter, white glass

special hardened safety glass, 4 mm thick, white, rounded edges, polished rim, dishwasher-safe, rubber feet included (adhesive), underside scratch-proof

item	version	l x w in cm
1670.01	square	50x50
1670.03	rectangular	50x34
1670.04	square	42x42
1670.06	square	34x34
1670.08	rectangular	80x21
1670.09	rectangular	80x40
1670.10	rectangular	30x18
1670.12	rectangular	66x10

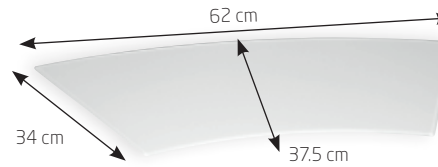

buffet platter Curve 45°

special hardened safety glass, 4 mm thick, white, curved shape, rounded edges, polished rim, dishwasher-safe, rubber feet included (adhesive), underside scratch-proof

item	l x w in cm	PU
1670.14	62x37.5	2 pcs

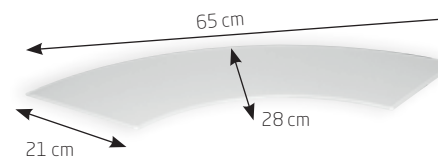

buffet platter Curve 90°

special hardened safety glass, 4 mm thick, white, curved shape, rounded edges, polished rim, dishwasher-safe, rubber feet included (adhesive), underside scratch-proof

item	l x w in cm	PU
1670.15	65x28	2 pcs



charger plate, white glass

special hardened safety glass, 4 mm thick, white, round, edge polished, dishwasher-safe, rubber feet included (adhesive), underside scratch-proof

item	Ø in cm
1671.33	33



buffet platter, white glass

special hardened safety glass, 4 mm thick, white, round, edge polished, dishwasher-safe, rubber feet included (adhesive), underside scratch-proof

item	Ø in cm
1671.53	53

Buffet platters made of white glass!

- Special hardened safety glass
- 4 mm thick, low weight
- Edges rounded and polished
- Underside scratch-resistant, white
- Shock-proof, heat-resistant, dishwasher-safe



Buffet platters made of satined glass!

- Special hardened safety glass
- 10 mm thick
- Edges polished and deburred
- Underside satined
- Dishwasher-safe

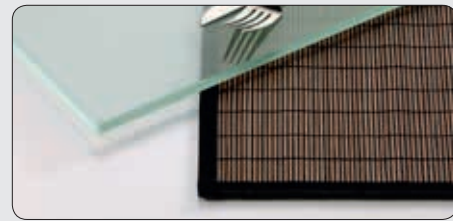

buffet platter, satined glass

hardened glass, 10 mm thick, satined, edges polished and deburred

item	version	l x w in cm
5243.M	rectangular	80x21



buffet platter, satined glass

hardened glass, 10 mm thick, satined, round, edge polished and deburred

item	Ø in cm
5240.M	60

Buffet platters made of transparent glass!

- Special hardened safety glass
- 10 mm thick
- Edges polished and deburred
- Dishwasher-safe

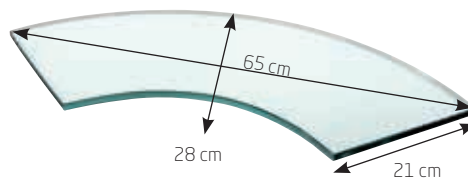
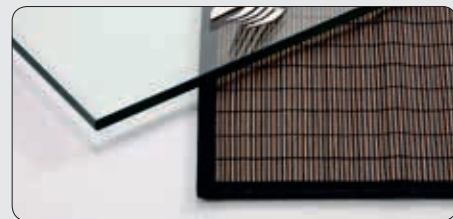

buffet platter Curve 90°

hardened clear glass, 10 mm thick, curved shape, edges polished and deburred

item	l x w in cm	PU
5241	65x28	2 pcs

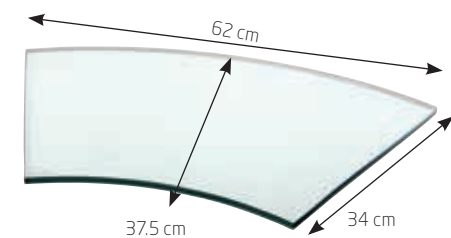

buffet platter Curve 45°

hardened clear glass, 10 mm thick, curved shape, edges polished and deburred

item	l x w in cm
5242	62x37.5

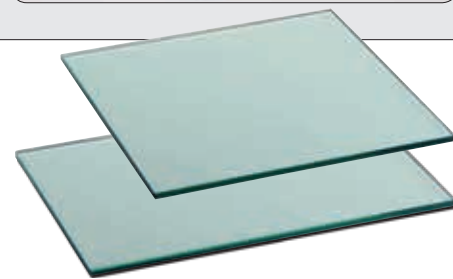

buffet platter, clear glass

hardened glass, 10 mm thick, edges polished and deburred

item	version	l x w in cm
8004.01	square	50x50
8004.02	rectangular	50x42
8004.03	rectangular	50x34
8004.04	square	42x42
8004.05	rectangular	42x34
8004.06	square	34x34
5243	rectangular	80x21
5000	rectangular	95.4x39



charger plate/glass insert

hardened clear glass, 6 mm thick, edge polished and deburred, for serving tray "Solid" item 4710

item	Ø in cm
4999	33

Glass steps and more!

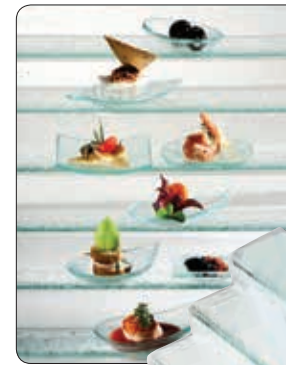

The buffet system "Skyline" is available on pages 14 to 19.

glass steps

5026.01: 32 cm long, 34 cm wide (horizontal position)
5026.02: 55 cm long, 42 cm wide (horizontal position)

item	l x w x h in cm (glass step)	thickness in mm
5026.01	29x34x12	6
5026.02	50x42x24	8



glass steps

deep black
5026.03: 32 cm long, 34 cm wide (horizontal position)
5026.04: 55 cm long, 42 cm wide (horizontal position)

item	l x w x h in cm (glass step)	thickness in mm
5026.03	29x34x12	6
5026.04	50x42x24	8

The glass steps items 5026... are adjusted to the Zieher system and due to their height of 12 resp. 24 cm can easily be combined with many Zieher buffet raisers (page 26).
Miniatures made of black glass are available on page 234.



glass steps

wavy, 7 steps, delivered in a wooden box, horizontal length: 67 cm/vertical length: 65 cm (in setup with glass stand item 5070.01)

item	version	width in cm
5076.01	transparent	40
5076.02	black-grey	40

glass stand

transparent, curved, for glass steps items 5076... and 5026.01/03

item	w x h in cm	PU
5070.01	14x12	2 pcs



glass tray

glass, deep black, rectangular, for buffet or flying buffet, also functions as a tray

item	l x w x h in cm
5141.26	26x14x2
5141.34	34x18x2
5141.50	51x35x2



glass tray

glass, deep black, square, for buffet or flying buffet, functions as a tray or as a charger plate

item	l x w x h in cm
5142.34	35x35x2



Delivery of all big glass steps in a solid wooden box!

“Stablo”- filigree versatility!

The buffet stands made of solid, brightly polished stainless steel impress by their high-quality workmanship and delicate appearance. Bowls and dishes almost appear hovering while slip-proof caps on the feet ensure safe support. The height of the stand (item 8016.01) is adjustable via extensions from 80 cm to 120 cm. Massive and bulky buffet tables become virtually redundant.

The buffet stand with its integrated ring (item 8016.01), allows for the presentation of plates and platters (max. dia. 21 cm on the lower level), but also for the insertion of extravagant wine coolers made of borosilicate glass. The coolers, positioned at an angle, may also be used with the “Stablo” stands in the sizes M and L.

The shape of the cooler corresponds to the already well-known Zieher glass cloches (pages 177 to 182), thicker quality borosilicate glass ensure the necessary stability! Due to its shape, any condensing water on the outside is drained off to the bottom tip. Dripping water can easily be caught by placing a small bowl on the floor or the buffet table. The integration of the optionally available Zieher rechargeable LED-lights creates breathtaking visual effects and puts champagne but also iced food in the limelight!



A three-staged buffet etagere is offering a lot of space for all kinds of food. It can be equipped with numerous trays and plates of the Zieher range. Anti-slip caps avoid annoying noise and ensure the safe grip of the trays.



The etagere with suitable trays is available on pages 57 und 58.

“Stablo”



Design: Uwe Kopp, Jörg Stricker

By positioning the cooler at an angle it is also suitable for buffet stands "Stablo" M and L.



buffet stand "Stablo"

massive stainless steel 18/10, polished, 8 mm thick, with 6 anti-slip rubber caps

item	Ø top/bottom in cm	height in cm	PU
8014.13	15/20.5	13.5	3 pcs
8014.20	15/23	20	3 pcs

The rechargeable LED-light item 8150 and suitable accessories are available on page 41.



Instruction sheet with detailed description: https://www.zieher.com/fileadmin/ZieherUploads/Bedienungsanleitungen/Bedienungsanleitung_Akku_LED_8150.pdf



buffet stand "Stablo" S, M, L

massive stainless steel 18/10, polished, 10 mm thick, with 6 anti-slip rubber caps

item	Ø top/bottom in cm	height in cm	PU
8015.20	22/30	20 / S	3 pcs
8015.30	22/35	30 / M	3 pcs
8015.40	22/39	40 / L	3 pcs



Positioning of ring and light



ring "SelectionA."

silicone, Ø 8.3 cm

item	colour	PU
4681.S	black	6 pcs
4681.W	white	6 pcs



wine cooler

borosilicate glass, transparent, handblown, handmade, reinforced version, for "Stablo" M, L items 8015.30 and 8015.40 (by positioning the cooler at an angle) and "Stablo" XL ring item 8016.01

item	Ø in cm	height in cm
4881.26	26	41-44



Also available separately!

buffet stand "Stablo" XL-ring

massive stainless steel 18/10, polished, 12 mm thick, with ring-opening (Ø 12 cm inside) for wine cooler items 4881.26 and 7010.26, with 6 anti-slip rubber caps, 3 of which are separately packed (to clip onto the bottom part while not using the extensions items 8017..., please order the extensions separately)

item	Ø top/bottom in cm	height in cm	PU
8016.01	22.5/37	40	3 pcs



Including 60 cm extensions.

illuminated wine cooler with stand: gift set "Stablo"

Set consists of:
wine cooler made of borosilicate glass
rechargeable LED-light incl. charging device, remote control and silicone ring to place the light on
stand "Stablo" XL-ring made of massive stainless steel 18/10, polished, with anti-slip rubber caps, incl. extension set with 60 cm length,
 1 set in black gift box

item	total height in cm	PU
8070.01PB	52/112	1 set (7 parts) 📦



extension "Stablo"

massive stainless steel 18/10, polished, 12 mm thick, with anti-slip rubber caps, for buffet stand "Stablo" item 8016.01 (not suitable for items 8014... and 8015...)

item	length in cm	PU
8017.40	40	1 set (3 parts)
8017.60	60	1 set (3 parts)
8017.80	80	1 set (3 parts)

Extension for buffet stand XL ring

8017.40: for a total height of 80 cm
 8017.60: for a total height of 100 cm
 8017.80: for a total height of 120 cm

Please note: For one buffet stand "Stablo" XL ring item 8016.01 only one set of extensions is required.

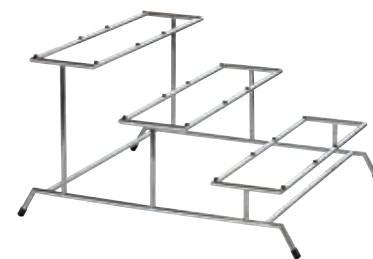

buffet etagere "Stablo"

massive stainless steel 18/10, 10 mm thick, with 4 anti-slip rubber caps and 24 rubber pads (for anti-slip placing of the trays), support for trays: 46.5 cm x 13 cm

item	l x w x h in cm
8013	46.5x54.5x30



tray

massive stainless steel 18/10, rectangular, hammered finish, six times polished, for buffet etagere items 2193, 2193.02 and 8013

item	l x w x h in cm
2193.01	62x18x5

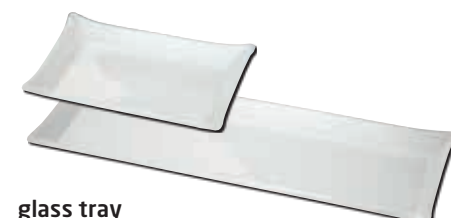

glass tray

satined, rectangular

item	l x w x h in cm
5160.31	31x21x3.5
5160.62	62x21x3.5



glass tray

dark grey, rectangular

item	l x w x h in cm
5161.31	31x21x3.5
5161.62	62x21x3.5





The buffet etagere item 2193.02 in hammered look is available on page 91.



buffet platter

special hardened safety glass, 4 mm thick, rectangular, rounded edges, polished rim, dishwasher-safe, rubber feet included (adhesive), underside scratch-proof

item	version	l x w in cm
1668.08	black glass	80x21
1670.08	white glass	80x21



buffet platter

hardened glass, grey transparent, rectangular, irregularly coloured in a cloudy look, underside structured, dishwasher-safe, scratch-proof

item	l x w in cm	thickness in mm
8008.08	80x21	8



base tray "Modul"

melamine, black, surface matt, food-safe, dishwasher-safe, not suitable for microwave and combi steam oven

item	l x w x h in cm	PU
4582	72.5x28x1.8	2 pcs



base tray "Modul"

walnut, food-safe sealed, not dishwasher-safe, stackable

item	l x w x h in cm
4722	70x25.5x3.1



buffet platter

laminated plastic, 8 mm thick, rectangular, black intermediate ply, break-proof, scratch-proof, dishwasher-safe, antistatic, deburred edges, rounded corners

item	version	l x w in cm
8001.08	matured wood look, white	80x21
8007.08	rusted look	80x21
8006.08	dark grey	80x21



grey glass bowls, page 69.

"Shine", page 61



"Reef", pages 62 to 64



"Capiz", page 65



"Fakir", pages 66 and 67

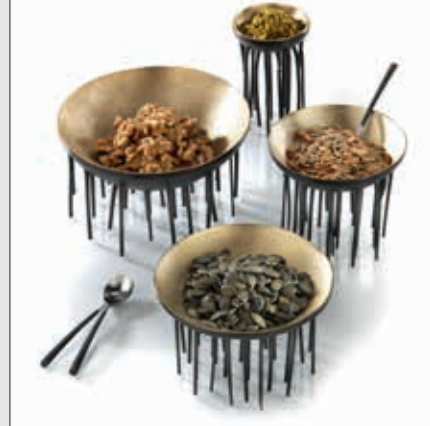

"Matrix", pages 66 and 67



"Cave", page 68



"Duplex", page 68



"Unique", page 71



Glass, dark grey, page 70 and 71



Page 73



"Art de Buffet", pages 78 to 86



"Solid", page 102 to 114



satined



bowl "Shine"

stainless steel 18/10, outside polished, inside satined, double-walled, round/oblique, dishwasher-safe

item	Ø in cm	height in cm	content in l
2260.16	15.7	6.7/8.8	0.5
2260.20	19.7	8.5/11	0.9
2260.24	23.7	10/13	1.6

ivory



bowl "Shine"

stainless steel 18/10, outside polished, double-walled, round/oblique, food-safe coating inside (colour: ivory, not dishwasher-safe)

item	Ø in cm	height in cm	content in l
2261.16	15.7	6.7/8.8	0.5
2261.20	19.7	8.5/11	0.9
2261.24	23.7	10/13	1.6

bowl "Shine"

in black gift box

item	Ø in cm	height in cm	content in l
2261.16PB	15.7	6.7/8.8	0.5
2261.20PB	19.7	8.5/11	0.9
2261.24PB	23.7	10/13	1.6

taupe



bowl "Shine"

stainless steel 18/10, outside polished, double-walled, round/oblique, food-safe coating inside (colour: taupe, not dishwasher-safe)

item	Ø in cm	height in cm	content in l
2262.16	15.7	6.7/8.8	0.5
2262.20	19.7	8.5/11	0.9
2262.24	23.7	10/13	1.6

Please note:
When cleaning the coated bowls (ivory and taupe coloured) in the dishwasher, the coating at the rim might abrade in the course of time. Therefore it is recommended to clean these items by hand.

Thermo-bowls "Shine"



The stainless steel bowls of the "Shine" series are double-walled and therefore have an isolating effect. This helps to prevent water condensation - even at elevated temperatures. Cold food stays cold and warm food stays warm longer.



The slim top edge appears elegant and filigree. The accentuated contrast between the highly polished outside and the unobtrusive finish on the inside (fine brushed stainless steel, ivory or taupe coloured) makes that series an eye-catcher. "Shine" is the perfect combination of elegance and subtlety. It is easily changeable to achieve a variation of presentations and it is effective in its double-walled construction.



"Reef"

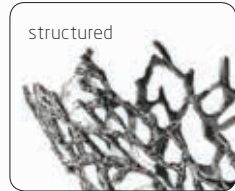

The bowls and baskets of the "Reef" series are veritable eye-catchers due to their organic structure and exceptional shapes. In the lobby or at the reception desk, which are both a hotel's hallmark, these impressive bowls guarantee lasting impressions with guests and visitors, especially when decorated with blossoms or flower bouquets.

Since medieval times, pewter has been used primarily for table top items and has been the most important raw material for them for a very long time. The popularity of pewter first started decreasing in the 18th and 19th century by the progressing development of glass and the increasing popularisation of porcelain. Since then the usage of pewter has shifted mainly to decorative elements. Up-to-date pewter is 100 % lead-free and therefore uncritical when used for food.



The displays of the "Classy" series are available on pages 36 and 37.



bowl/basket "Reef"
pewter, structured and patinated outside, oval, food-safe, not dishwasher-safe

item	l x w x h in cm
2332	20x10x12

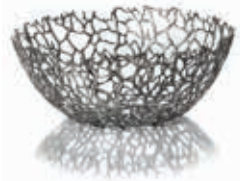

bowl/basket "Reef"
pewter, structured and patinated outside, round, food-safe, not dishwasher-safe

item	Ø in cm	height in cm
2334	33	14



bowl/basket "Reef"
pewter, structured and patinated outside, food-safe, not dishwasher-safe, with supporting feet

item	w x d x h in cm
2335	54x18x66



bowl/basket "Reef"
pewter, structured and patinated outside, food-safe, not dishwasher-safe, with supporting feet

item	l x w x h in cm
2336	75x10x14

bowl/basket "Reef"
in black gift box

item	l x w x h in cm
2336.PB	75x10x14

"Reef"



bowl/basket "Reef"
pewter, surface smooth, food-safe, not dishwasher-safe, with feet

item	l x w x h in cm
2314.01	approx. 15x9x24
2314.02	approx. 21x12.5x33
2314.03	approx. 37x18.5x52

bowl/basket "Reef"
in black gift box

item	l x w x h in cm
2314.01PB	approx. 15x9x24
2314.02PB	approx. 21x12.5x33
2314.03PB	approx. 37x18.5x52



bowl/basket "Reef"
pewter, smooth outside, round, high, food-safe, not dishwasher-safe

item	Ø in cm	height in cm
2312.01	36	45
2312.02	23	36



bowl/basket "Reef"
pewter, smooth outside, oval, food-safe, not dishwasher-safe

item	l x w x h in cm
2313.01	46x19x20
2313.02	32x13x13



Large numbers of single parts are casted from premium pewter and subsequently assembled in high-grade craftsmanship to give shape to these items. The inimitable pieces of art created that way are unique items which inspire by the polished surface of the organic structures and the rounded tails of the meshwork. The products of the "Reef" series are genuine gems of dining culture! Whether it is bowls filled with bread or fruit in the focus of attention or high-quality textiles held together by extravagant napkin rings emphasizing the ambiance, or the delightful shadow play of candlelight creating an atmospheric ambiance - "Reef" turns any table into a fine dining experience.

Used as storage space for jewellery or standing on its own as a decorative sculpture, even off the table the bowls find their application. Even carefully draped towels are also exquisitely presented in the bathroom or in the wellness area. The outside texture of the bowls differs within the series: whether smoothly rounded (page 63 and 64) or roughly structured with dark, patinated deepenings (page 62), each variant has its own charm!



"Reef"

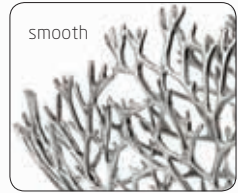

napkin ring "Reef"

pewter, surface smooth, food-safe, not dishwasher-safe

item	Ø in cm	length in cm	PU
2317	5.5x3.5	7.5	2 pcs

napkin ring "Reef"

in black gift box

item	Ø in cm	length in cm	PU
2317PB	5.5x3.5	7.5	2 pcs



bowl/basket "Reef"

pewter, smooth outside, round, food-safe, not dishwasher-safe, with supporting feet, for small glass bowl item 5166 (please order separately)

item	Ø in cm	height in cm
2310	13	8



glass bowl

glass, 6 mm thick, dark grey, organically shaped, for bowl/basket "Reef" item 2310 (please order separately)

item	Ø / height in cm	content in l	PU
5166	13 / 6.5	approx. 0.3	2 pcs

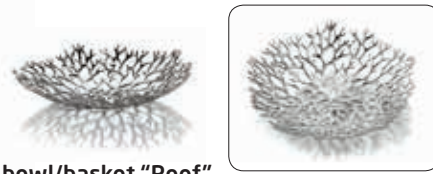

bowl/basket "Reef"

pewter, smooth outside, round, flat, food-safe, not dishwasher-safe

item	Ø in cm	height in cm
2311	22	5



candle holder/wind light "Reef"

pewter, surface smooth, food-safe, not dishwasher-safe, with feet, for glass insert item 4991.02 and candles up to Ø 7 cm

item	Ø in cm	height in cm
2315.01	10	15.5



wind light

borosilicate glass, satined inside, open at the top and at the bottom, for candle holder/wind light "Reef" item 2315.01

item	Ø in cm	height in cm	PU
4991.02	9	14.5	6 pcs

For tealights or candles up to a height of 10 cm and a diameter of 7 cm.



candle holder/wind light "Reef"

Set consists of:
candle holder/wind light "Reef" made of pewter, surface smooth, food-safe, not dishwasher-safe, with feet, for candles up to Ø 7 cm

glass insert made of borosilicate glass, satined inside, open at the top and at the bottom, 1 set in black gift box

item	Ø in cm	height in cm	PU
2316PB	10	16.5	1 set (2 parts)

"Capiz"

Ivory-coloured clamshells with a nacreous gloss grant these products their special appeal. In combination with crushed ice and the Zieher rechargeable LED-lights, the double-walled bowls produced in mosaic-look create fascinating effects, thus becoming the eye-catcher at the buffet. The double-walled construction provides insulating characteristics. This prevents the formation of condensate on the outside of the bowls to the greatest possible extent. More items of the series are available on page 168.



bowl "Capiz"

shell, ivory-coloured, double-walled, round, rim approx. 2 cm wide, resin-coated, not dishwasher-safe

item	Ø in cm	height in cm
7109.46	46	23

bowl "Capiz"

in black gift box

item	Ø in cm	height in cm
7109.46PB	46	23

Separates ice and melt water



charger plate, white glass

special hardened safety glass, 4 mm thick, white, round, edge polished, dishwasher-safe, rubber feet included (adhesive), underside scratch-proof

item	Ø in cm
1671.33	33



bowl "Capiz"

shell, ivory-coloured, double-walled, round, with slightly cone-shaped bottom, rim approx. 3 cm wide, resin-coated, not dishwasher-safe

item	Ø in cm	height in cm
7112.36	36	17.5



bowl "Capiz"

shell, ivory-coloured, oval, resin-coated, not dishwasher-safe

item	l x w x h in cm
7106.46	46.5x24x13.5



The rechargeable LED-light item 8150 is available on page 41.



Please note the care instructions: suitable for cold and dry food, not dishwasher-safe.

"Matrix"



bowl "Matrix"

brass, top golden (transparent coating, food-safe), bottom dark patinated, hexagonal, flat, not dishwasher-safe

item	Ø in cm	height in cm
2382.38	38	7



bowl "Roots"

brass, golden (transparent coating, food-safe), round, not dishwasher-safe

item	Ø in cm	height in cm
2381.38	38	8

bowl "Roots"

in black gift box

item	Ø in cm	height in cm
2381.38PB	38	8



bowl/display "Fakir"

brass, inside golden (transparent coating, food-safe), outside dark patinated, not dishwasher-safe

item	Ø in cm	height in cm
2380.07	7.5	11
2380.12	12.5	10
2380.15	15	8.5
2380.18	18	9.5

The silicone feet may be detached if needed.



coaster/glass insert

hardened clear glass, 4 mm thick, round, edge polished and deburred, with 4 transparent silicone feet

item	Ø in cm	PU
5244.09	9	6 pcs
5244.11	11	6 pcs
5244	13	6 pcs
5244.17	16.7	1 pc.
5244.21	20.7	1 pc.
5244.24	24.2	1 pc.
5244.28	28.2	1 pc.

"Roots, Matrix & Fakir" - Brass all of a piece!



The buffet stands of the "Somnia" series are available on page 8.

"Fakir"

Massive brass produced in traditional sand casting creates unique sculptural items, which enthuse especially by their contrast between matt golden surfaces and dark patination. Opposing in form and shape but still belonging together these bowls "Roots" and "Matrix" as well as the exceptional displays of the "Fakir" series add up to a harmonic overall composition.

The bowls "Roots", a tight web of rootlike structures, and "Matrix", strictly geometrically constructed of hexagons, could hardly be more opposing. Especially this aspect makes the combination of the two so interesting. Besides the presentation of bread and fruit on the buffet these bowls fascinate as sculptures or decorative elements as well. An interesting add-on to the "Fakir" bowls are round glass platters of the Zieher product range. These can be laid on easily and generate thus the option to use the impressive objects on both sides.

All items are golden-coloured and partially dark patinated, further discolouration or oxidation is prevented reliably by the food-safe sealing of the golden parts.



"Cave"



glass bowl "Cave"

dark grey, round, handblown, ground edge

item	Ø in cm	opening Ø in cm	height in cm
4815.18	approx. 18	approx. 14	approx. 11.5
4815.24	approx. 24	approx. 19	approx. 16.5

glass bowl "Cave"

in black gift box

item	Ø in cm	opening Ø in cm	height in cm
4815.18PB	approx. 18	approx. 14	approx. 11.5
4815.24PB	approx. 24	approx. 19	approx. 16.5

The glass version of the "Cave" bowl is available in two sizes. The soft tinge of this grey glass, which is manufactured in a traditional hand-blowing process, at first glance allows an unobstructed view onto the content of these shapely objects. They offer the fitting framework for fruit, nuts and nibbles as well as for tastefully arranged pasta or salad on a solemnly decorated table. The content of the bowls remains protected by the shell of glass, the amply dimensioned opening seduces to snap at a chance. These unique items enthuse as well as a place to keep all kinds of accessories. "Cave" in a smaller version made of china is available on page 166.

"Duplex"

The grey solid coloured glass of these handblown unique pieces serves as an unobtrusive background and suitable framework for perfectly arranged dishes. The bowls can be used on both sides. A soft recess is formed when the closed side is up for ambitious dishes. By using it upside down there will be more capacity which is ideal e. g. to fill in ice.



The rechargeable LED-light item 8150 is available on page 41.



Useable on both sides!



glass bowl "Duplex"

dark grey, round, bottom side open, useable on both sides

item	Ø in cm	height in cm
4813.28	28	6.5
4813.35	35	7.5
4813.46	46	10



Please note: We recommend the use of the silicone rings items 4681... with the smallest bowl



glass bowl

dark grey, round, handblown, ground edge

item	Ø in cm	height in cm	content in l
4814.17	17	5.5	approx. 0.3
4814.23	23	9.5	approx. 1.5
4814.30	30	13	approx. 3.25
4814.40	40	10	approx. 4.5

4814.17 + 4681.S



ring "SelectionA."

silicone, Ø 8.3 cm, for glass bowl item 4814.17

item	colour	PU
4681.S	black	6 pcs
4681.W	white	6 pcs

4814.23 + 4682.S



ring "SelectionA."

silicone, Ø 13.4 cm, for glass bowl items 4814.23 and 4814.30

item	colour	PU
4682.S	black	3 pcs
4682.W	white	3 pcs

The handblown bowls made of grey-tinted glass are deliberately restrained in their design, yet they have been shaped to exhibit high versatility in their appearance.

The combination of the bowls with the gold-coloured stands of the "Somnia" series (page 8) creates an opulent and extravagant buffet staging which is fascinating purely by its appearance. In connection with the anthracite displays of the "Spike" series (pages 10 and 11) they appear rather futuristic and modern. The subtle grey tinting of the glass bowls matches perfectly with the matt black or white surface of the optionally available silicone rings which form a non-slip basis and increase stability.



The buffet displays "Spike" are available on pages 10 and 11.

The buffet stands "Somnia" are available on pages 8 and 9.





The buffet displays “Classy” are available on pages 36 and 37.



buffet bowl
glass, 8 mm thick, dark grey, oblong, structured

item	l x w x h in cm
5703	96x29x10

The glass miniature is available on page 227.



glass plate
glass, 8 mm thick, dark grey, rectangular, with the structure of tree bark

item	l x w in cm	PU
5702	40x22	2 pcs



glass plate
glass, 8 mm thick, dark grey, oval, with the structure of tree bark

item	l x w in cm	PU
5700	33x24	3 pcs



glass bowl
glass, 8 mm thick, dark grey, oval, with the structure of tree bark

item	l x w x h in cm	PU
5701	26.5x19.5x4.5	3 pcs



glass bowl „Unique“
black marbled, bottom satined, round

item	Ø in cm	height in cm	content in l
5183.16	16	approx. 5	approx 0.67
5183.21	21	approx. 5	approx 2.0
5183.27	26,5	approx. 8	approx 2.75



glass bowl „Unique“
white marbled, bottom satined, round

item	Ø in cm	height in cm	content in l
5183216	16	approx. 5	approx 0.67
5182.21	21	approx. 5	approx 2.0
5182.27	26,5	approx. 8	approx 2.75



The total series “Unique” is available on page 146.



buffet bowl
glass, 8 mm thick, dark grey, oval, structured, delivery in strong wooden box

item	l x w x h in cm
5176	130x42x8



glass bowl
glass, 6 mm thick, dark grey, oval, structured

item	l x w x h in cm
5175.41	41x19.5x5.5
5175.44	44.5x25x6



The buffet stands “Crossline” are available on page 12, small bowls made of dark grey glass on page 235.





glass tray
dark grey, rectangular

item	l x w x h in cm
5161.31	31x21x3.5
5161.62	62x21x3.5



glass tray
satinated, rectangular

item	l x w x h in cm
5160.31	31x21x3.5
5160.62	62x21x3.5



Each of these high grade bowls is unique and almost completely handcrafted. At this, coloured glass is completely covered with crystal clear glass. This process awards the bowls with top brilliance and an impressive look. The handblown glass blank is modelled manually, whereby unique pieces are created which excite by their organic shape.

bowl
clear glass, black, handblown, wavy, with clear rim

item	Ø in cm	height in cm
4811.01	approx. 38-40	approx. 9.5
4811.02	approx. 50-52	approx. 14
4811.03	approx. 56-58	approx. 15



bowl
clear glass, white, handblown, wavy, with clear rim

item	Ø in cm	height in cm
4810.01	approx. 38-40	approx. 9.5
4810.02	approx. 50-52	approx. 14
4810.03	approx. 56-58	approx. 15

Please note:
Due to the complex production process, small air inclusions in the glass are inevitable!



The buffet stands are available on page 82.



glass platter
glass, structured, transparent, square

item	l x w in cm
5063	30x30
5063.50	50x50



buffet bowl
glass, satinated, square

item	l x w in cm
5014.38	38x38



buffet bowl
glass, transparent, wide rim, structured

item	Ø in cm	height in cm
5049.35	35	6

buffet bowl
glass, transparent, wide rim, structured

item	Ø in cm	height in cm
5024.45	45	11



buffet bowl
glass, satinated, concentric shape with steps

item	Ø in cm	height in cm
5013.46	46	5.5

"Artisan"



charger plate "Artisan"
 stainless steel 18/10, inside polished, outside matt finish, round, hammered rim with golden adornment (brass), utility space smooth finish

item	Ø in cm
2375.33	33



bread/pastry bowl "Artisan"
 stainless steel 18/10, inside polished, outside matt finish, oval, flat, hammered rim with golden adornment (brass), bottom smooth finish

item	l x w x h in cm
2372	22x15x3.5

bread/pastry bowl "Artisan"
 stainless steel 18/10, inside polished, outside matt finish, oval, high, hammered rim with golden adornment (brass), bottom smooth finish

item	l x w x h in cm
2373	22x13x7



bowl "Artisan"
 stainless steel 18/10, inside polished, outside matt finish, round, hammered rim with golden adornment (brass)

item	Ø in cm	height in cm	content in l
2371.07	7.5	3.5	approx. 0.1
2371.11	11	5.5	approx. 0.3
2371.14	14.5	7	approx. 0.7

Please note: When cleaning in the dishwasher the brass rim may change colour in the course of time. Therefore it is recommended to clean these items by hand.

"Artisan"



tray "Artisan"
 stainless steel 18/10, inside polished, outside matt finish, oval, hammered rim with golden adornment (brass), utility space smooth finish

item	l x w in cm	height in cm
2374.24	24.5x15	approx. 1.5



tray "Artisan"
 stainless steel 18/10, inside polished, outside matt finish, round, hammered rim with golden adornment (brass), utility space smooth finish

item	Ø in cm	height in cm
2370.23	23	approx. 2.5
2370.28	28	approx. 3.0
2370.33	33	approx. 3.0
2370.39	39	approx. 3.5

The trays and bowls of the "Artisan" series are fascinating and diversified at the same time. The inside with its perfectly polished surface creates an interesting contrast to the matt outside.

The handcrafted rim impresses by its irregularity and is crowned by a circumferential brass edge. The combination of hammered and plain surfaces, of massive stainless steel and brass, awards this series with that certain something.

"Artisan" is a series of contrast!



The plane surface of the trays facilitates the service and prevents unpleasant noise. When used at the buffet, arranged food can be presented in an appealing way and is accentuated by the reflection of the polished surfaces.

etagere "Artisan"
 stainless steel 18/10, inside polished, outside matt finish, round, not dishwasher-safe, hammered rim with golden adornment (brass), with brass handle, demountable, with 3 rubber feet

item	Ø in cm	height in cm
2376	33/28/23	45



Stainless steel - refined!



We gladly offer you buffet displays, bread baskets or cruet stands etc. with different surfaces. This option is feasible for almost all products made of stainless steel.

Highly polished as well as matt stainless steel can be refined in gold, copper or black colour in PVD refining. Price, minimum order quantity and delivery time upon request. Please ask us, we will gladly prepare an individual offer for you!



stainless steel, polished



golden



black



copper

Advantages of the PVD coating:

- Food-safe
- Dishwasher-safe
- Better strength and adherence compared to galvanic refinement
- Brilliant colouring, colourfast and resistant against UV radiation

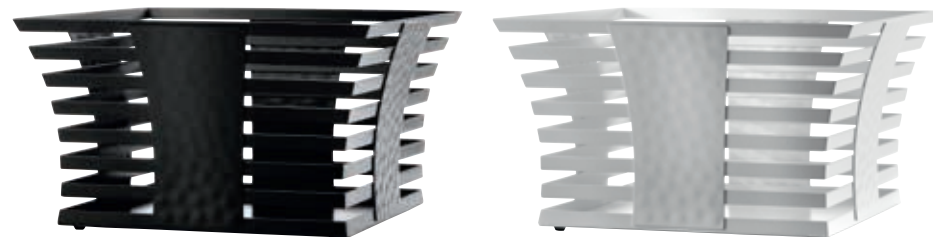

All items made of stainless steel can be powder-coated in all current RAL colours upon request. In contrast to the PVD refining this coating is not dishwasher-safe. We will be delighted to advise you!

Etagere "DressCoat"

NEW



Food: Pâtisserie Walter
www.patisserie.de



Anti-slip-rings



Etagere "DressCoat"

massive stainless steel 18/10, hammered, polished, 3-armed

item	Ø in cm	height in cm
2212.30	36	30



plateau plate "DressCoat"

white china, useable area (plateau): Ø 19.5 cm, also useable as a bowl

item	Ø / height in cm	content in l	PU
4388	22 / 6.5	0.9	3 pcs

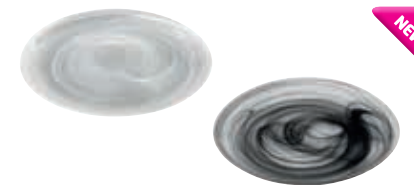

glass plate "Unique"

glass, black marbled, bottom satined, round

item	Ø in cm	colour	PU
5178.21	21	white	6 pcs
5179.21	21	black	6 pcs

The etagere with three tiers, made of hammered and highly polished stainless steel, forms an extravagant basis for many sorts of plates and platters. The supporting rings with a diameter of 15 cm offer the possibility to insert not only plates and platters, but alternatively also bowls. Small black silicone rings keep inserted porcelain in position and prevent annoying clattering.

A very special aesthetic set-up can be arranged by using a combination of several etageres along with the biggest plate of the "DressCoat" series (page 148). Numerous presentation areas on a total of four different levels can be created by placing additional plates directly on the table. The diameter of 22 cm is more than sufficient to put different pralines, petit fours and other creations of confectionery into the limelight in an impressive way. In connection with the almost invisible tier stands the porcelain tablecloths appear amazingly airy and playful by their floating look-and-feel. A buffet presentation with an elegant vibrancy caused by the drapery of the "DressCoat" plates - that's where it comes into its own!

Even in the hotel room the etageres can be positioned in an eye-catching way. Equipped with "DressCoat" or other tableware, small snacks, a selection of fruit or a sweet welcoming treat can be staged in an appealing way.



The entire series "DressCoat" is available on page 148, the series "Unique" on pages 146/147.

Please note: We recommend the use of large plates on the lower level only.

The XXL bowl item 2170 is available on page 83.

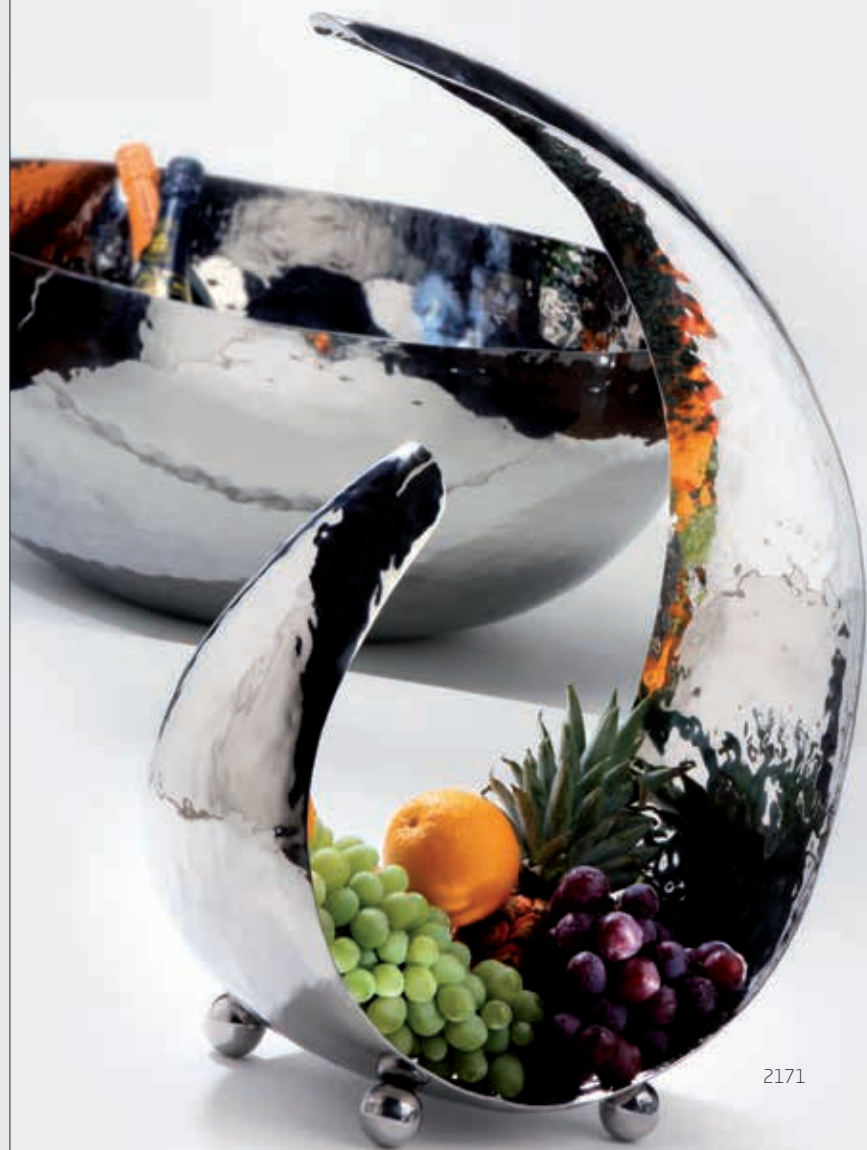

2171

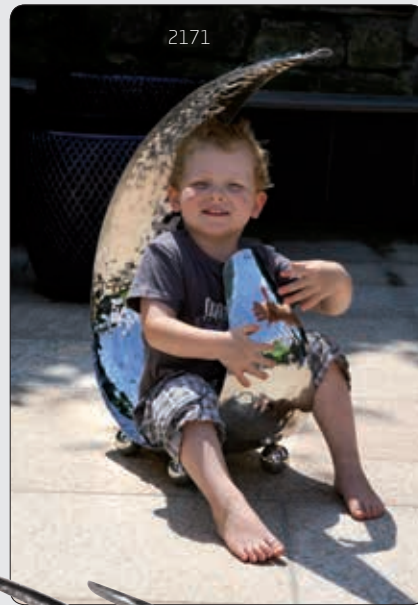

2171



bowl "Sixth Sense"

massive stainless steel 18/10, hammered finish, six times polished, with stainless steel feet

item	l x w x h in cm
2171	48x25x74
2171.01	37x17.5x54
2171.02	20x12x34

The stainless steel bowls are available on page 81.



bowl "Sixth Sense"

massive stainless steel 18/10, hammered finish, six times polished, with stainless steel feet, 15.5 cm long, 8 cm wide, 24.5 cm high

item	version
2171.03	stainless steel



The exceptional design of the "Art de Buffet" series acts as an eye-catcher in both modern and elegantly traditional buffets. It presents artistically arranged dishes in a favourable way. Every piece of this series is made of massive stainless steel 18/10, has a hand-made hammered finish and is six times hand-polished.

Please note: The baseplate has to be mounted!



bowl "Loop"

massive stainless steel 18/10, oval, hammered finish, six times polished, with black marble foot

item	l x w x h in cm
2109	39x19x67

bowl "Loop"

in black gift box

item	l x w x h in cm
2109.PB	39x19x67



bowl "Wings"

massive stainless steel 18/10, hammered finish, six times polished

item	l x w x h in cm
2169	34 x 22 x 48



"Art de Buffet"

The bread/pastry bowls are available on page 85.



bowl "Wings"

massive stainless steel 18/10, hammered finish, six times polished

item	l x w x h in cm
2169.01	21x12.5x30.5
2169.02	15.5x9x19





smooth



etagere

massive stainless steel 18/10, triangular, smooth finish, six times polished, not demountable

item	Ø in cm	height in cm
2187	13	16.5



bowl

massive stainless steel 18/10, triangular, smooth finish, six times polished

item	Ø in cm	height in cm	content in l
2182.09	9	4	0.08
2182.13	13	6	0.28
2182.22	22	10.5	1.25
2182.30	30	12	3.0



hammered



bowl

massive stainless steel 18/10, triangular, hammered finish, six times polished

item	Ø in cm	height in cm	content in l
2180.09	9	4	0.08
2180.13	13	6	0.28
2180.22	22	10.5	1.25
2180.30	30	12	3.0
2180.40	40	16	7.0

bowl

in black gift box

item	Ø in cm	height in cm	content in l
2180.22PB	22	10.5	1.25
2180.30PB	30	12	3.0



etagere

massive stainless steel 18/10, round, hammered finish, six times polished, with stainless steel feet, not demountable

item	Ø in cm	height in cm
2197	50/40/30	33

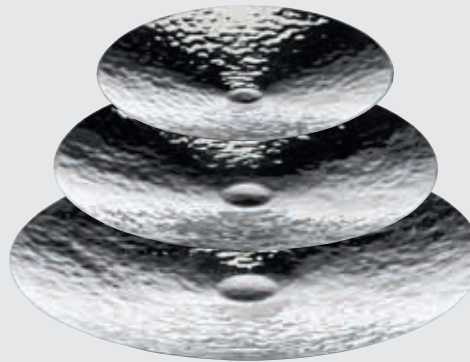

bowl

massive stainless steel 18/10, hammered finish, six times polished, with 4 feet

item	Ø in cm	height in cm
2199.30	30	3.5
2199.40	40	4.5
2199.50	50	5



etagere

massive stainless steel 18/10, round, hammered finish, six times polished, not demountable

item	Ø in cm	height in cm
2198	27/22/18/14	50

etagere

in black gift box

item	Ø in cm	height in cm
2198.PB	27/22/18/14	50

"Art de Buffet"



Feet ensure safe standing!



The rings made of silicone are available on page 158.



The glass bowls are available on page 72.



5329.25 (page 175) + 2141.01



buffet stand

massive stainless steel 18/10, highly polished

item	Ø in cm	height in cm
2141.01	25/20	13
2141.02	27/22	17.5
2141.03	29/25	23



2174 + 2141.01



bowl

massive stainless steel 18/10, oblique, hammered finish, six times polished

item	Ø in cm	height in cm
2174	38	7/15



bowl/basin XXL

massive stainless steel 18/10, round, hammered finish, six times polished

item	Ø in cm	height in cm	content in l
2170	70	30	85

illuminated champagne bowl

set consists of:

champagne bowl made of massive stainless steel 18/10, polished

2 rechargeable LED-lights, with charging device and remote control

separating plate made of hardened glass (10 mm thick), satined

item	Ø / height in cm	content in l	PU
2200.PB	70 / 30	85	1 set (6 parts)

2170 + 8150 + 5240.M
Separates ice and melt water

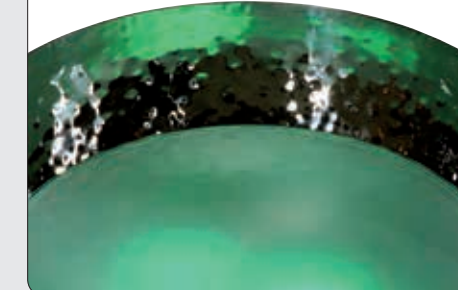

buffet platter/separating plate

hardened glass, 10 mm thick, satined, round, reduces useable capacity of XXL bowl to approx. 40 l content (15 cm usable depth)

item	Ø in cm
5240.M	60



hand pump

highly elastic PVC, 2.5 mm thick, with hose, for easy drainage of melt water, professional quality, vacuum capacity: 10 l/min

item	Ø hose in cm	total length hose in cm
5662	2	250



"Art de Buffet"



The bowl "Sixth Sense" is available in 4 sizes on page 78.



The XXL bowl "Konkret!" is available on page 29.

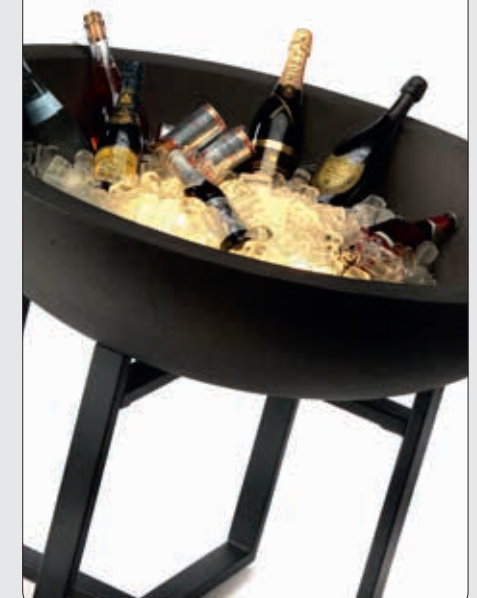

It is recommended to clean the horn-ball feet only with moist, soft tissues and non-abrasive substances. Cleaning in the dishwasher may damage the sealing.



buffet bowl

massive stainless steel 18/10, oblong, hammered finish, six times polished

item	l x w x h in cm
2184	62x15x7



buffet bowl

massive stainless steel 18/10, square, hammered finish, six times polished, with horn-ball feet

item	l x w x h in cm
2132	31x31x17

The five-stage etagere item 2119 is available on page 90.



bowl

massive stainless steel 18/10, oblong, hammered finish, six times polished, 41 cm long, 15.5 cm wide, 6.5 cm high

item	version
2116.41	stainless steel



bowl

massive stainless steel 18/10, oblong, hammered finish, six times polished

item	version
2116.71	stainless steel



champagne bowl

massive stainless steel 18/10, hammered finish, six times polished, Ø 39 cm, 18 cm high, 1.8 l content

item	version
2163	stainless steel



bowl

massive stainless steel 18/10, oval, hammered finish, six times polished

item	l x w x h in cm
2183	40x23x9/18.5



buffet bowl

massive stainless steel 18/10, oval, hammered finish, six times polished

item	l x w x h in cm
2117	40.5x25x8.5

The bowl "Loop" is available on page 79.



bread/pastry bowl

massive stainless steel 18/10, hammered finish, six times polished

item	l x w x h in cm
2121.22	24x15x8



bowl

massive stainless steel 18/10, round, hammered finish, six times polished

item	Ø in cm	height in cm	content in l
2181.17	17	6.5	1.1
2181.21	21	8.0	2.0
2181.24	24	9.5	3.25



2163 + 5024.45 (page 72)

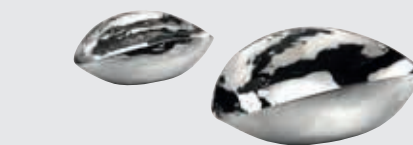

bread/pastry bowl

massive stainless steel 18/10, hammered finish, six times polished

item	l x w x h in cm
2133.12	12x7.5x4.5
2133.19	19x11.5x6.5



tray

massive stainless steel 18/10, rectangular, hammered finish, six times polished

item	l x w in cm
2186	38x28

The tongs holder is available on page 95.

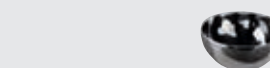

small bowl

massive stainless steel 18/10, round, hammered finish, six times polished

item	Ø in cm	content in l
2153	7.5	0.11

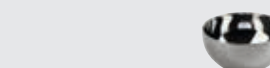

small bowl

massive stainless steel 18/10, round, smooth finish, six times polished

item	Ø in cm	content in l
2153.01	7.5	0.11



bowl

massive stainless steel 18/10, oval, smooth finish, six times polished

item	l x w x h in cm	content in l
2159.16	16x10x3.5/7	approx. 0.2
2159.20	20x12x5/9	approx. 0.35

bowl

in black gift box

item	l x w x h in cm	content in l
2159.16PB	16x10x3.5/7	approx. 0.2
2159.20PB	20x12x5/9	approx. 0.35

New

Buffet bowl



The two buffet bowls repeat the organic design of the miniatures and etageres and offer enough space for the presentation of food on the buffet. When combined with the etageres and plateau plates of this series, a varied but at the same time harmonious staging of the buffet is guaranteed.



bowl flat
stainless steel 18/10, hammered

item	l x w x h in cm
2206.50	50 x 40 x 6.5



bowl flat
stainless steel 18/10, hammered

item	l x w x h in cm
2206.60	60 x 46 x 7.5



bowl flat
in black gift box

item	l x w x h in cm
2206.50PB	50 x 40 x 6.5



amuse gueule stand with foot
stainless steel 18/10, hammered

item	l x w x h in cm
2204.08	11.5 x 9.5 x 8.5
2204.11	11.5 x 9.5 x 11.5



ice cream cup with foot
stainless steel 18/10, hammered

item	l x w x h in cm	height in cm
2207.11	11.5 x 10 x 11	0.15
2207.15	13.5 x 11 x 15	0.25



etagere
massive stainless steel 18/10, hammered, polished, 7 miniature plates (approx. 9 cm x 8 cm)

item	Ø in cm	height in cm
2202	25	9

etagere
in black gift box

item	Ø in cm	height in cm
2202.PB	25	9



etagere with 3 tiers
massive stainless steel 18/10, hammered, polished, 21 miniature plates (approx. 9 cm x 8 cm)

item	Ø in cm	height in cm
2201	25	44.5

etagere with 3 tiers
in black gift box

item	Ø in cm	height in cm
2201.PB	25	44.5

"Flower-Tower"

New



Floral shapes in a steely gloss!

Seemingly organic shapes in an interplay with the gloss and reflections of hammered and polished stainless steel make up the special charm of this product line. Two etageres as well as plateau plates in different heights (page 89) allow a visually harmonious yet flexible and diversified presentation of appetizers or desserts on the buffet. But also finger food, petit-fours, elaborately decorated cup cakes or a selection of pralines in the guest room find a convenient stage on these products. The ice cream/sorbet cups and petit-fours stands in various sizes make a nice complement and individually stage appetizers or a dessert.

The formal base for all products is a slightly arched and kidney-shaped miniature plate. On three levels, the buffet etagere combines seven small plates each to a presentation platform of floral appearance and offers space to present up to 21 delicacies in a compact and stylish way. The single levels are supported by a filigree trestle made of massive stainless steel which in shape and construction deliberately readopts the design of other Zieher etageres. So nothing gets in the way of a harmonic combination of the different product lines.

The table etagere consists of one level only and is therefore perfectly suitable for the restaurant service to present intermediate courses, antipasti or dessert variations. This product is the ideal choice even as a stylish storage dish for different types of fruit or accessories of daily use.



holder coil shape
massive stainless steel 18/10, hammered finish, six times polished, for inserts made of china and glass

item	Ø in cm	total height in cm
2167.15	5.5	20
2167.20	5.5	25
2167.25	5.5	30
2167.30	5.5	35



marble platter
black/brown, polished surface, sides rough-textured, stainless steel feet, 24 holes (Ø 5 mm), for holder coil shape items 2167... or skewer item 1939.02 (please order separately)

item	l x w x h in cm
8052	45x31x5



skewer "Flame"
stainless steel 18/10, polished

item	length in cm	PU
1939.02	24	12 pcs



miniature glass
clear glass

item	Ø / height in cm	content in l	PU
5405	5 / 8.6	0.1	6 pcs



marble platter
black/brown, polished surface, sides rough-textured, rectangular, with 3 holes (Ø 5 mm), with 4 feet of felt (not dishwasher-safe), for holder coil shape items 2167... or skewer item 1939.02 (please order separately)

item	l x w in cm
8022.02	30x10x2.5



glass miniature
borosilicate glass, transparent, handblown, double-walled, with reinforced rim

item	Ø / height in cm	content in l	PU
4901.03	6 / 7.5	approx. 0.08	6 pcs

miniature
china, stackable, Ø 5.3 cm, 7 cm high, 0.1 l content

item	colour	PU
4490	white	6 pcs
4490.01	black	6 pcs



bowl
granite, anthracite, fully polished

item	Ø in cm	height in cm
8034	18	7



Please note:
Positioning of plateaus with same height is only possible to a limited extent.



miniature plate with rod
massive stainless steel 18/10, hammered, polished, plate approx. 9 cm x 8 cm, for marble platter 8052 and 8022.02

item	height in cm
2203.08	8
2203.13	13
2203.18	18
2203.23	23

Single presentation plateaus, whose small plates are similar to those of the "Flower Tower" etageres (page 87), are available in four different heights and can be arranged individually. A firm stand for these is offered by the Zieher skewer plates made of dark brown marble, which are available with three and - for the use on the buffet - 24 bore holes.



Design: Itamar Harari



For the placement with glass platters we recommend the use of non-slip silicone sleeves (item 4683).



buffet etagere

massive stainless steel 18/10, hammered finish, six times polished, including 5 trays item 2119.01 (66 cm long, 8 cm wide, 3 cm high)

item	w x d x h in cm	PU
2119	66x54x32	1 set (6 parts)

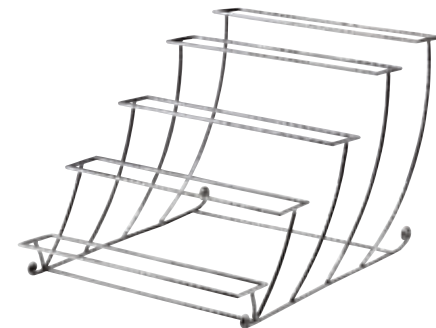

buffet etagere

massive stainless steel 18/10, hammered finish, six times polished, delivery without trays item 2119.01 (please order separately)

item	w x d x h in cm
2119.02	38x54x31



tray

massive stainless steel 18/10, rectangular, hammered finish, six times polished, for buffet etagere items 2119 and 2119.02

item	l x w x h in cm
2119.01	66x8x3



buffet platter

special hardened safety glass, 4 mm thick, rectangular, rounded edges, polished rim, dishwasher-safe, rubber feet included (adhesive), underside scratch-proof

item	version	l x w in cm
1668.12	black glass	66x10
1670.12	white glass	66x10



silicone sleeve

transparent, slotted alongside, for buffet etagere items 2119, 2119.02, 2193 und 2193.02 (prevents the slipping of glass platters)

item	length in mm	PU
4683	10	24 pcs



buffet etagere

massive stainless steel 18/10, hammered finish, six times polished, including 3 trays item 2193.01 (62 cm long, 18 cm wide, 5 cm high)

item	w x d x h in cm	PU
2193	62x42x32.5	1 set (4 parts)



buffet platter

laminated plastic, 8 mm thick, rectangular, black intermediate ply, break-proof, scratch-proof, dishwasher-safe, antistatic, deburred edges, rounded corners

item	version	l x w in cm
8001.08	matured wood look, white	80x21
8007.08	rusted look	80x21
8006.08	dark grey	80x21



buffet platter

hardened glass, grey transparent, rectangular, irregularly coloured in a cloudy look, underside structured, dishwasher-safe, scratch-proof

item	l x w in cm	thickness in mm
8008.08	80x21	8



buffet platter

special hardened safety glass, 4 mm thick, rectangular, rounded edges, polished rim, dishwasher-safe, rubber feet included (adhesive), underside scratch-proof

item	version	l x w in cm
1668.08	black glass	80x21
1670.08	white glass	80x21



buffet platter

hardened glass, 10 mm thick, rectangular, edges polished and deburred

item	version	l x w in cm
5243	transparent glass	80x21
5243.M	satined glass	80x21
5243.B	dark grey glass	80x21



buffet etagere

massive stainless steel 18/10, hammered finish, six times polished, delivery without trays item 2193.01 (please order separately)

item	w x d x h in cm
2193.02	46x42x31



Glass trays are available on page 57.

tray

massive stainless steel 18/10, rectangular, hammered finish, six times polished, for buffet etagere items 2193, 2193.02 and 8013

item	l x w x h in cm
2193.01	62x18x5



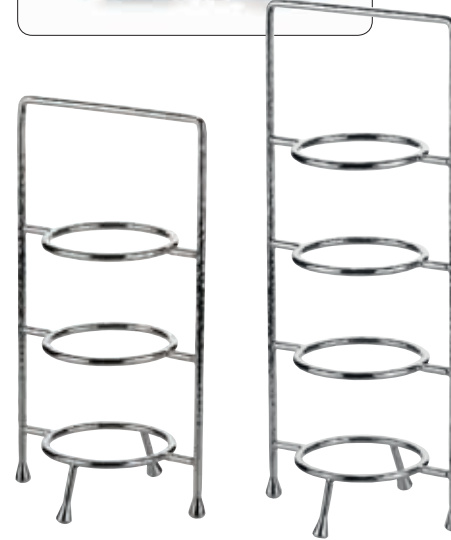

etagere

massive stainless steel 18/10, hammered finish, polished, with 3 or 4 insertion levels (Ø inside: 6.5 cm) for plates/bowls with max. Ø 11 cm

item	l x w x h in cm	levels
2107.03	12.5x11.5x23	3
2107.04	12.5x11.5x29	4

etagere

massive stainless steel 18/10, hammered finish, polished, with 3 or 4 insertion levels (Ø inside: 10.8 cm) for plates/bowls with max. Ø 17.5 cm

item	l x w x h in cm	levels
2105.03	20.5x18x37.5	3
2105.04	20.5x18x47.5	4



tray

massive stainless steel 18/10, square, hammered finish, six times polished, with feet

item	l x w x h in cm
2101.17	17.5x17.5x2.3

Elegantly served and presented in style - classic plate etageres, newly inspired!

Shapely and individual stands by Zieher are suitable for numerous applications. The classic plate etageres are available with three or four levels and in two sizes. Petit fours, desserts, chocolates or other delicacies are effectively presented by the classic mini format etageres. The larger versions are perfectly suitable for scones and jam during Five O'Clock Tea, but also a choice of cold cuts, cheese or fruit can be staged elaborately on the set table. Numerous suitable inserts made of china, glass, and stainless steel are available on pages 260 und 261.



2107.04 + 4607.10



2107.04 + 4606.10



2107.03 + 3954.08



2107.03 + 4324.11



etagere with miniature plates

set consists of:
etagere made of massive stainless steel 18/10, hammered finish, polished, with four insertion levels (Ø inside: 6.5 cm) for plates/bowls with max. Ø 11 cm
mini plate (5 pcs incl. 1 replacement plate), china, black, matt, round, flat, Ø 10.5 cm,
 1 set in black gift box

item	l x w x h in cm	PU
2106.04PB	12.5x11.5x29	1 set (6 parts)



etagere with plates

set consists of:
etagere made of massive stainless steel 18/10, hammered finish, polished, with three insertion levels (Ø inside: 10.8 cm) for plates/bowls with max. Ø 17.5 cm
plate (4 pcs incl. 1 replacement plate), china, black, matt, round, flat, Ø 17 cm
 1 set in black gift box

item	l x w x h in cm	PU
2103.03PB	20.5x18x37.5	1 set (5 parts)



2105.03 + 5179.16



2105.03 + 4606.17



2105.03 + 2101.17

"Art de Buffet"



Elegantly served - stylishly presented!
Whether it is five o'clock tea, breakfast or finger food - etageres by Zieher offer a maximum use of minimum space.



etagere

massive stainless steel 18/10, hammered finish, six times polished, including 3 removable trays item 2110.01 (30 cm long, 8 cm wide, 3 cm high)

item	l x w x h in cm (etagere only)
2110	11.5x11.5x39 (height without handle)



tray

massive stainless steel 18/10, rectangular, hammered finish, six times polished, with feet, for etagere item 2110

item	l x w x h in cm
2110.01	30x8x3



pastry tray

massive stainless steel 18/10, rectangular, hammered finish, six times polished

item	l x w in cm
2136	30x12.5



sushi tray

massive stainless steel 18/10, hammered finish, six times polished

item	l x w in cm
2160.66	66x8

The tongs have a thickness of 4 mm, they rest perfectly in the hand and convey a sense of quality!



The jam trays are available on page 262.



toast rack

massive stainless steel 18/10, hammered finish, six times polished, for 4 slices of toast

item	l x w x h in cm
2190	20x8.5x15



tongs holder

massive stainless steel 18/10, hammered finish, six times polished, for tongs up to a length of 24 cm

item	l x w x h in cm
2115	27.5x9.5x28



spoon rest

massive stainless steel 18/10, rectangular, hammered finish, six times polished

item	l x w in cm
2154	18x10



chocolate/ice cube tongs

massive stainless steel 18/10, hammered finish, six times polished, 19 cm long

item	version
2138	stainless steel



serving tongs

massive stainless steel 18/10, hammered finish, six times polished, 21.5 cm long

item	version
2140	stainless steel



serving tongs

massive stainless steel 18/10, hammered finish, six times polished

item	length in cm
2139	28



dressing/jam jar

china, white

item	Ø in cm	height in cm	content in l
4458	13.5	20	1.75



table display

china, white, for self-labeling

item	l x w in cm	PU
4076	8x4.5	6 pcs

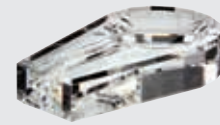

ashtray for cigars

optical glass, transparent, also usable as a rest for tongs or spoons, in black gift box

item	l x w x h in cm
5210	15x9x3



small glass bowl/spoon rest

glass, 4 mm thick, structured, dark grey, organically shaped, slight oval form

item	l x w in cm	PU
5172	11x7.5	12 pcs



spoon rest/glass miniature

glass, 4 mm thick, dark grey, with spiral structure

item	l x w in cm	PU
5168.06	approx. 6.5x5	12 pcs

More dark grey glass platters are available on page 173.



"Fingerfood-Tree"

Wildly bent tree branches supported by a base made of polished stainless steel: The fingerfood-trees by Zieher are absolutely delightful due to their extraordinary look and variable uses achieved by the different attachments!



A number of suitable attachments and applications offer a lot of possibilities and form the basis for the chef's imagination. The fingerfood-trees are perfect for patisserie creations, savory snacks in the form of mini-wraps or skewers, fruit with chocolate icing or just for jam at breakfast buffets. Furthermore they can be placed on both buffets and bar tables with the solid base ensuring stability.

This extraordinary way of presenting fingerfood will surprise and fascinate your guests and will definitely leave a lasting impression.

The fingerfood-trees are furnished with 30 branches, which in turn can be fitted with 5 suitable attachments (page 98). Besides a clip that holds wooden skewers and a spiral for small wraps and waffles, we offer rings in three sizes, the medium size of which is especially designed for holding small jam jars (e.g. Bonne Maman).

Velcro straps to fasten the branches and a stout carrier bag are available from the accessory section and allow easy transport and space-saving storage of the bent trees.

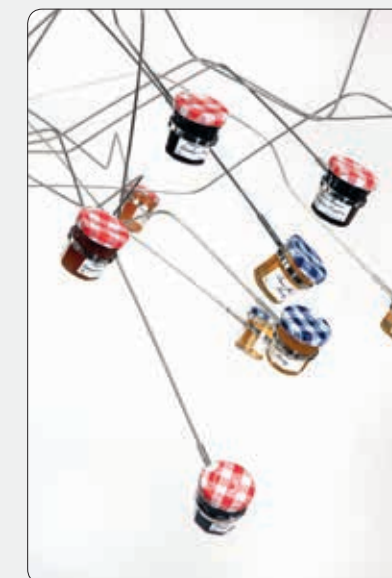

Design: Jochen Gromann



Equipped with rings size M the fingerfood-tree is perfectly suitable for presenting portion jam, e. g. Bonne Maman.

spring clip support

stainless steel 18/10, polished, to screw onto the "branches" of the fingerfood-tree item 8018.01

item	length in cm	PU
8019.01	7	10 pcs

Ring size M is suitable for portion jam in conical glasses (e. g. Bonne Maman)



ring support

stainless steel 18/10, polished, to screw onto the "branches" of the fingerfood-tree item 8018.01

item	size	Ø in cm (inside)	PU
8019.02	S	2.8	10 pcs
8019.03	M	3.8	10 pcs
8019.04	L	5.6	10 pcs



spiral support

stainless steel 18/10, polished, to screw onto the "branches" of the fingerfood-tree item 8018.01

item	Ø in cm	height in cm	PU
8019.05	4.5 / 2.0	4.5	10 pcs



For ring size S

glass cone

clear glass

item	Ø / height in cm	content in l	PU
5415	3.5 / 8	0.03	12 pcs



For ring size L

glass miniature

borosilicate glass, transparent, handblown, double-walled, with reinforced rim

item	Ø / height in cm	content in l	PU
4901.03	6 / 7.5	approx. 0.08	6 pcs



For spiral support

glass cloche

borosilicate glass, transparent, handblown, handmade

item	Ø in cm	height in cm	PU
4982.05	5	approx. 8-9	6 pcs

Design: Jochen Gromann

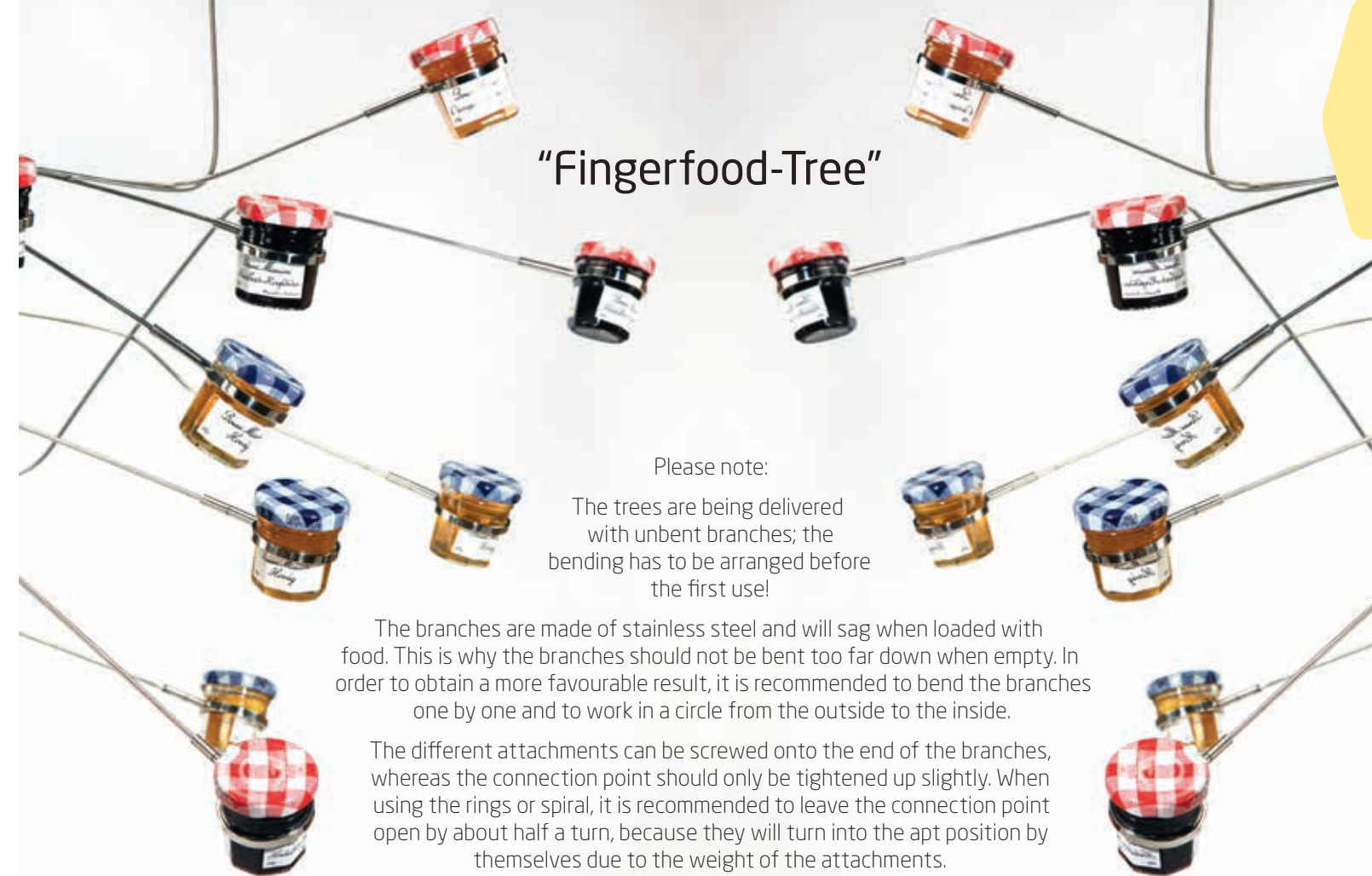

"Fingerfood-Tree"

Please note:
The trees are being delivered with unbent branches; the bending has to be arranged before the first use!

The branches are made of stainless steel and will sag when loaded with food. This is why the branches should not be bent too far down when empty. In order to obtain a more favourable result, it is recommended to bend the branches one by one and to work in a circle from the outside to the inside.

The different attachments can be screwed onto the end of the branches, whereas the connection point should only be tightened up slightly. When using the rings or spiral, it is recommended to leave the connection point open by about half a turn, because they will turn into the apt position by themselves due to the weight of the attachments.



Increased stability through larger base plate.



transport bag

polyester, black, with zip and 2 carrying straps, for fingerfood-tree item 8018.01

item	l x w x h in cm
8018.T	150x29x29



fingerfood tree

stainless steel 18/10, polished, 30 "branches" of equal length (87 cm) of stainless steel wire, with 6 feet of felt, height after bending of "branches": approx. 90 cm - 110 cm, threaded ends for attachment of several supports items 8019... (please order separately)

item	Ø in cm (foot)	height unbent
8018.01	25	121 cm



hook-and-loop strap

black, with chrome-plated clasp, for easy transport and space-saving storage of the fingerfood-tree item 8018.01

item	l x w in cm
5660	43x2.5



The glass stands with a suitable cloche are available on page 184, the miniatures on pages 203 to 239.



All parts of this series consist of form-glued authentic wood veneer, the bridges are available in two types of wood. The light version harmonizes very well with mundane but also with rustic-style furnishing, the version with the black-brown stripes appears exotic and modern.

More items for the room service/ guestrooms are available on pages 285 to 298.



buffet bridge "Podia", triple pack
genuine wood veneer, light colouring (similar to oak), not dishwasher-safe

item	w x d x h in cm	PU
8731	30x20x6 (1st bridge)	1 set
	36x20x9 (2nd bridge)	
	42.5x20x12 (3rd bridge)	

Please note the care instructions!



GN tray "Podia"
genuine wood veneer, dark (black-brown striped), not dishwasher-safe

item	l x w in cm	GN	PU
8732.03	32.5x26.5	1/2	6 pcs

The buffet bridges and trays of the "Podia" series offer several advantages!

They are light but robust, flexibly usable and can be stored in a space-saving way. With its use as a display on the buffet, during coffee break or as a platter for fruit or little somethings in the hotel room - "Podia" offers multiple possibilities for use and flexible handling.

The tray in 1/2 GN format is especially suitable for different miniatures made of porcelain and glass. Anti-slip silicone coasters in different styles (page 210) guarantee a good grip during service.



buffet bridge "Podia", triple pack
genuine wood veneer, dark (black-brown striped), not dishwasher-safe

item	w x d x h in cm	PU
8730	30x20x6 (1st bridge)	1 set
	36x20x9 (2nd bridge)	
	42.5x20x12 (3rd bridge)	



Hotelcosmetics: PAM Berlin
Slipper & Hotel Supplies
www.pam-berlin.de

Not dishwasher-safe, do not immerse in water!

New



Please note:
The Zieher cutting boards are oiled. The use naturally wears down their surfaces. In case of smaller abrasions, rub down the surface with a thin layer of vegetable oil or special care oil for wooden kitchen countertops to refresh the surface. The above mentioned items are not dishwasher-safe. Please check the enclosed leaflet for detailed care instructions.



glass cloche

borosilicate glass, transparent, handblown, handmade, for coaster "Solid" items 4734...

item	Ø in cm	height in cm
4880.26	26	approx. 41-44



glass cloche

clear glass, handblown, with round handle, for saucer "Solid" items 4734...

item	Ø in cm	height in cm
4852	26	43



cutting board "Solid"

walnut (end grain), oiled, stackable, not dishwasher-safe, with juice rim/groove to place cloches

item	Ø in cm	height in cm
4776	29	5



stacking ring "Solid"

walnut, oiled, not dishwasher-safe, with stacking rim to place cloches

item	Ø in cm	height in cm
4777	29	8.5



bowl „Solid“

walnut, oiled, not dishwasher-safe, with stacking rim to place cloches

item	Ø in cm	height in cm
4778	29	8.5



Further sizes and variations of the cloches are available on pages 116/117 and 177 to 185.



4776 + 4880.26



4776 + 4852



4778 + 4880.26

"Solid"

New



The high-quality cutting board made of fine end grain walnut wood is much more than a shapely and elegant kitchen aid. This product only unfolds its full potential in connection with the belonging stacking rings and bowls. All parts have a groove at the top, which allows quick and easy stacking of the various items, even in mixed arrangement.

The milled groove of the cutting board on the one hand serves as a juice groove and on the other hand as a receptacle for various glass cloches. Thus aromatic types of cheese can be presented. A classic cloche made of hand-blown glass or an extravagant organically shaped cover made of highly durable borosilicate glass protects and stages the food at the same time. The stacking ring creates different levels of presentation when used in a clustered arrangement of cutting boards and trays. Also, the capacity of the bowls can be increased so as to present, for example, long baguettes.

The system blends harmoniously into the walnut wood series "Solid". Using further sizes of the glass cloches on the buffet allows for impressive arrangements.

Cutting board, ring and bowl are sealed with high quality oils. Especially regarding the cutting board, this enables the simple refurbishment of the surface from traces of daily wear and tear.



4777 + 4778



4776 + 4777 + 4778



4776 + 4777



4776 + 4777 + 4778



4880.26 + 4776 + 4777 + 4778

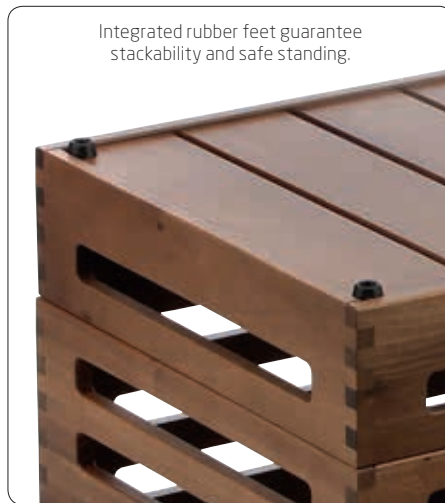

Integrated rubber feet guarantee stackability and safe standing.

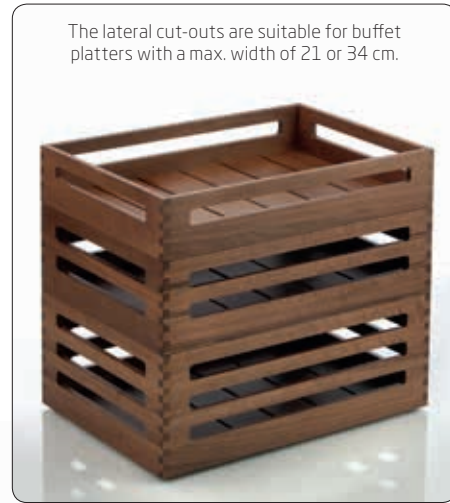

The lateral cut-outs are suitable for buffet platters with a max. width of 21 or 34 cm.

The “Mercato” buffet baskets made of walnut are inspired by classic market boxes, but they are superior in many respects. Finger joints in the corners for maximum stability, solid walnut in modern design as well as deliberately chosen dimensions of the heights and lateral cut-outs offer numerous advantages. “Mercato” can be converted quickly and flexibly into a buffet display by the use of buffet platters. These platters (pages 45 to 51) can simply be laid on or pushed into the lateral cut-outs of the baskets (max. width 21 or 34 cm). In addition to the mere presentation of fruit or baked goods, “Mercato” is also ideal for the coffee break or for placing miniatures of any kind.

The integrated rubber feet ensure safe standing and guarantee the stackability of the baskets. Bread, rolls and pastries remain crisp and fresh longer, as the slotted bottom plates allow sufficient air circulation.

The “Solid” bed tray is a nice addition to this system. Due to its integrated, foldable feet, it can do without risers for elevated positioning. For more information on the bed tray please see page 113, for the fitting “Solid” breakfast buffet please check pages 106 to 111.



buffet display/basket “Mercato”

walnut, food-safe sealed, not dishwasher-safe, stackable, with 4 rubber feet (screwed on)

item	l x w x h in cm
4768.08	43x30x8
4768.12	43x30x12
4768.16	43x30x16

Bread and more ...



The buffet displays "Solid" made of walnut are available on page 38, the trays of the "Modul" series on page 132.



tray stand "Solid"

walnut, food-safe sealed, not dishwasher-safe, with 6 rubber feet and 16 anti-slip feet on the top side, for 2 serving trays "Solid" items 4707.PB and 4740

item	l x w x h in cm
4718	72.5x51x5 / 22



tray stand "Solid"

walnut, food-safe sealed, not dishwasher-safe, removable cover strip, with 6 rubber feet and 8 anti-slip feet on the top side, 2 pieces combinable with connector piece "Solid" item 4747 (for buffet setup of two pieces item 4746 one above the other), for 1 serving tray "Solid" items 4707.PB or 4740

item	l x w x h in cm
4746	42x51x5 / 13.5



The cutting board and the bridge "Solid" are available on pages 110 and 111.



connector piece "Solid"

walnut, food-safe sealed, not dishwasher-safe, for buffet setup of 2 pieces of the tray stand item 4746 one above the other, with 2 boreholes for wall mounting (optional, mounting material not included)

item	l x w x h in cm
4747	46.8x12x54.5

... attractively presented!

"Solid"



The presentation of bread is not only important at the table, but at the breakfast buffet, too. The variety of baked goods wants to be put in the limelight.

Oblique displays for one or two wooden trays allow for a clear arrangement of various types of bread. With the help of a connector piece, two of these tray displays (item 4746) may be stacked and used on top of each other - the ideal solution for small buffet tables. A fitting cutting board including a crumb drawer and an exchangeable grate, a cutting board made of end grain wood as well as various bridges (to be found on pages 110 and 111) complete the series and provide the healthy and diversified breakfast with a new look.

Besides the flat bread tray you can also find a deeper version of that tray which is suited especially for the presentation of rolls, buns, biscuits and pastries. A removable grate provides air circulation, freshly baked buns remain scrumptious longer. Two kinds of divisions (for the tray) offer space for several miniatures (pages 271 and 272) and allow for a flexible use of the system. A cutlery insert for the deep tray as well as an insert for slices of toasted bread round off the range.

Wood from the European walnut tree, which is one of the most precious and most beautiful types of wood, forms the basis for this series. Both the wood's warm brown colours in different shades and its intensive and distinctive grain make every product a unique item!



Suitable miniatures in sizes 5 cm x 5 cm or 7 cm x 7 cm are available on pages 271 and 272.



More items of the "Solid" walnut series are available on pages 244 to 255.



Glass inserts
1668.03 and 1670.03
please order separately.

servicing tray "Solid"

walnut, flat, food-safe sealed, not dishwasher-safe, with 2 recessed grips, with 4 rubber feet, in black gift box

item	l x w x h in cm	l x w (inside) in cm
4707.PB	53x37x4	50.2x34.2



tray insert "Solid"

walnut, food-safe sealed, not dishwasher-safe, divides the tray into 8 sections (length: 31.9 cm, width: 5.4 cm each), for serving trays "Solid" items 4707.PB and 4740 and miniatures with a max. width / Ø of 5 cm

item	l x w x h in cm
4742	50x34x2.9



tray insert "Solid"

walnut, food-safe sealed, not dishwasher-safe, divides the tray into 6 sections (length: 31.9 cm, width: 7.5 cm each), for serving trays "Solid" items 4707.PB and 4740 and miniatures with a max. width / Ø of 7 cm

item	l x w x h in cm
4743	50x34x2.9



buffet platter

special hardened safety glass, 4 mm thick, rectangular, rounded edges, polished rim, dishwasher-safe, rubber feet included (adhesive), underside scratch-proof, for serving tray "Solid" items 4707.PB and 4740

item	version	l x w in cm
1668.03	black glass	50x34
1670.03	white glass	50x34



servicing tray "Solid"

walnut, deep, food-safe sealed, not dishwasher-safe, 2 recessed grips, with 4 rubber feet

item	l x w x h in cm
4740	53x37x10



4740 + 4745



tray insert "Solid"

walnut, food-safe sealed, not dishwasher-safe, divides the tray into 4 sections (length: 32 cm, width: 3x 13 cm and 1x 8 cm), for serving tray "Solid" item 4740

item	l x w x h in cm
4745	50x34x7



cutlery insert "Solid"

walnut, food-safe sealed, not dishwasher-safe, divides the tray into 4 sections (length: 24.9 cm, width: 11.2 cm each), for serving tray "Solid" item 4740 (for cutlery with a max. length of 24.7 cm)

item	l x w x h in cm
4744	50x27x7



grate insert "Solid"

walnut, food-safe sealed, not dishwasher-safe, with 9 rubber feet (6 mm high), for serving trays "Solid" items 4707.PB and 4740

item	l x w x h in cm
4741	49.8x33.8x2

"Solid"



The miniatures made of glass and china are available on pages 271 and 272.



The tray stand/side table "Solid" is available on page 286.



4707.PB + 4741



4707.PB + 4743



4707.PB + 4742



4707.PB + 1668.03
4707.PB + 1670.03



4740 + 4741



4740 + 4744



4740 + 4743



4740 + 1670.03

"Solid"



bread cutting board "Solid"

walnut, oiled, not dishwasher-safe, with 4 rubber feet, with walnut grate (39.8 cm long, 24.3 cm wide, 1.8 cm high, exchangeable) and 18/10 stainless steel drawer for crumbs (with magnetic fixing)

item	l x w x h in cm
4733	48x32.5x4.3

The changeable grate of the "Solid" cutting board has been constructed to protrude slightly from the cutting board to protect its rim.



replacement grate "Solid"

walnut, oiled, for bread cutting board "Solid" item 4733

item	l x w x h in cm
4733.R	39.8x24.3x1.8



cutting board "Solid"

walnut (end grain), oiled, not dishwasher-safe, with 4 rubber feet (screwed on), in black gift box

item	l x w x h in cm
4732.PB	48x32.5x4.8



cutting board "Solid"

walnut (end grain), oiled, stackable, not dishwasher-safe, with juice rim/groove to place cloches

item	Ø / height in cm
4776	48/5

Show cooking is a popular trend!

Whether using it for catering, at events or at the hotel's own buffet, the solid wood cutting boards by Zieher are pleasing eyecatchers and offer high functionality. The matching bridges can be equipped with bowls, putting everything tidily within reach for the work behind the buffet.

The dimensions of both, cutting boards and bridges, have been chosen in such a way that exactly two boards and two bridges would fit into a regular transportation box. This is extremely useful when it comes to storing the items for their daily use and transportation for catering purposes.

"Solid" is entirely made of walnut, probably the most beautiful and most stylish of the European woods.

More items from this series can be found on pages 244 to 255.



Please note:

The Zieher cutting boards are oiled. The use of the cutting boards naturally wears down their surfaces. In case of smaller abrasions, rub down the surface with a thin layer of vegetable oil or special care oil for wooden kitchen countertops to refresh the surface. The removable grate for the bread cutting board (item 4733) can be ordered separately as a spare part (item 4733.R). The above mentioned items are not dishwasher-safe. Please check the enclosed leaflet for detailed care instructions.



bridge "Solid"

walnut, food-safe sealed, not dishwasher-safe, with 4 rubber feet

item	l x w x h in cm
4730	54x17x16



bridge "Solid"

walnut, food-safe sealed, not dishwasher-safe, with 3 tapered holes (Ø 12 cm top side/11 cm underside), with 4 rubber feet, for bowls with max. Ø 15 cm

item	l x w x h in cm
4731	54x17x12



bowl "Shine"

stainless steel 18/10, outside polished, double-walled, round/oblique, Ø 15.7 cm, 6.7 / 8.8 cm high, 0.5 l content, for bridge "Solid" item 4731

item	colour inside
2260.16	satined (dishwasher-safe)
2261.16	ivory (not dishwasher-safe)
2262.16	taupe (not dishwasher-safe)



bowl "Catering de Luxe"

white china, for bridge "Solid" item 4731

item	Ø / height in cm	content in l	PU
4281	14 / 5.5/7.5	0.35	6 pcs



ham holder "Solid"

walnut, food-safe sealed, not dishwasher-safe, granite and massive stainless steel 18/10, with knife rest (for knives with a max. size of 43 cm x 3.5 cm)

item	l x w in cm
4749	50x26



"Solid"



Other kinds of wood upon request! (custom built)



maple
ash
elm



The porcelain pillows "Donna" are available on page 144.

"Connect!"



The cutting boards are pluggable and can be connected with each other.



cutting/snack board "Connect!"

walnut, oiled, not dishwasher-safe, pluggable, with handle, with 4 rubber feet, in black gift box

item	l x w x h in cm	length incl. handle
4774.31PB	26.5x20x2.3	31



cutting/snack board "Connect!"

walnut, oiled, not dishwasher-safe, pluggable, with handle, with 4 rubber feet, in black gift box

item	l x w x h in cm	length incl. handle
4775.44PB	40x16x2.3	44.5



servicing tray "Solid"

walnut, food-safe sealed, not dishwasher-safe, with 4 rubber feet

item	l x w x h in cm	l x w in cm (inside)
4713	34x34x3	32x32



servicing tray "Solid"

walnut, food-safe sealed, not dishwasher-safe, stackable, 2 compartments: 30 cm x 30 cm and 30 cm x 8 cm (for cutlery or china/glass bowls), with 4 rubber feet

item	l x w x h in cm
4769	41.7x32.5x6.7

The serving tray and suitable glass inserts are available on page 108, more "Solid" items on pages 246 to 255.



Serving platters made of walnut!

Sublime in their appearance, unadorned in design, practical by compact formats and highly functional in combination - the solid wood boards of the series "Connect!" convince as a snack board, serving and cutting board or as a presentation platter, created by the combination of several elements. "Connect!" is an extremely versatile tool for everyday use. The integrated tenon in the shape of a dovetail serves as a decorative handle with an artisanal touch. Suitable cutouts at the underside allow an easy combination of different elements. Skid-proof positioning feet ensure a firm stand, the slanted outer edges facilitate handling. The solid walnut wood is sealed with high-quality oils which makes it easy to freshen up the surface from traces of everyday wear and tear.



All information about the serving tray "Solid" item 4769 is available on page 289.



The buffet system "Mercato" is available on page 104.

The roomservice tray as well as the bed tray with feet stand out due to the precious walnut wood which is incorporated into these products with high-quality craftsmanship. The recessed longside enables comfortable dining directly off the tray. The retractable feet of the bed tray have been constructed in a very stable way and are securely kept in position by integrated magnets when folded in. The tray also cuts a good figure on the buffet. The positioning feet make it possible to dispense with the use of displays for heightened placing. A speedy set-up and flexible handling facilitate daily operations.



bed tray „Solid“

walnut, food-safe sealed, not dishwasher-safe, stackable, with feet, 2 handles, recessed on one side of the rim, in black gift box

item	l x w x h in cm (closed)	l x w x h in cm (set up)
4773.PB	60x40x6.5	approx. 74x40x31



The rubber feet are set back from the rim to enable the transport in a tray trolley in 1/1 EN-format (60 cm x 40 cm).



roomservice tray "Solid"

walnut, food-safe sealed, not dishwasher-safe, stackable, recessed on one side of the rim, with 2 handles, with 4 rubber feet, suitable for tray stand "Solid" item 4748

item	l x w x h in cm
4735	60x40x5.4

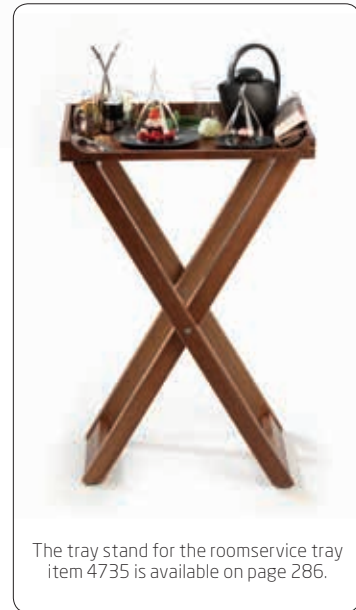

The tray stand for the roomservice tray item 4735 is available on page 286.



"Solid"



card holder

walnut, varnished, slot 2 mm wide

item	l x w x h in cm	PU
4726	8x3x3	4 pcs



bowl "Solid"

walnut, oblique, food-safe sealed, not dishwasher-safe

item	Ø in cm	height in cm
4760	13	10.5
4761	14	9



bowl "Solid"

walnut, round, food-safe sealed, not dishwasher-safe, stackable, with corrugated pattern outside

item	Ø in cm	height in cm
4711.18	18	6
4711.24	24	8
4711.30	30	10

4710 + 1669.33



serving tray "Solid"

walnut, round, food-safe sealed, not dishwasher-safe, stackable, with corrugated pattern outside

item	Ø in cm	height in cm
4710	36	4



charger plate/glass insert

special hardened safety glass, 4 mm thick, dishwasher-safe, edge polished, rubber feet included (adhesive), underside scratch-proof, for serving tray "Solid" item 4710

item	version	Ø in cm
1669.33	black glass	33
1671.33	white glass	33



charger plate/glass insert

hardened clear glass, 6 mm thick, edge polished and deburred, for serving tray "Solid" item 4710

item	Ø in cm
4999	33



The bread basket is available on page 251.



4591 + 4588



cutlery/napkin box

melamine, black, surface matt, food-safe, dishwasher-safe, with 4 rubber feet, not suitable for microwave and combi steam oven, for cocktail napkins folded to 1/8

item	l x w x h in cm	content in l	PU
4591	16x6x4.5	0.26	2 pcs



cutlery box

melamine, black, surface matt, food-safe, dishwasher-safe, not suitable for microwave and combi steam oven, for cutlery with a length of up to 23.5 cm

item	l x w x h in cm	PU
4594	26.5x16.2x7.2	4 pcs



cutlery box "Solid"

walnut, food-safe sealed, not dishwasher-safe, with acrylic glass lid, with 4 rubber feet, for cutlery with a length of up to 24.3 cm

item	l x w x h in cm
4720	26.5x16.2x8



buffet display "Solid"

walnut, food-safe sealed, not dishwasher-safe, bottom side open, can be used as a stand or as a container

item	l x w x h in cm	PU
4767.12	12x12x12	2 pcs
4767.24	12x12x24	2 pcs



4594 + 4589

The melamine GN tray item 4589 is available on page 123.



Grooves to let water from the dishwasher run off



The cutlery boxes item 4720 (wood) and 4594 (melamine) are stackable in all commercial transport boxes in format 60 cm x 40 cm.



The cutlery/napkin box for the table is available on page 247.

Each cloche on this page is handblown and handcrafted. In contrast to our cloches made of borosilicate glass (page 117), these items are made of a single massive glass drop. As a result there can be air inclusions and minor streaks which cannot be avoided. Each cloche is individual, the result is a harmonic enlivenment of the buffet for an attractive price.



More cloches made of glass and china are available on pages 177 to 185.



glass cloche

clear glass, handblown, with round handle, for saucer "Solid" items 4734...

item	Ø in cm	height in cm
4850	18.5	31
4851	22.5	37
4852	26	43



glass cloche

clear glass, for pastry/cake stand items 5349...

item	Ø in cm	height in cm
5350.16	16	13
5350.23	23	16.5
5350.27	27.5	20.5



pastry/cake stand

clear glass, with foot

item	Ø in cm	Ø foot in cm	height in cm
5349.21	21	10.5	9.5
5349.28	28	13	11.5
5349.33	33.5	13	11

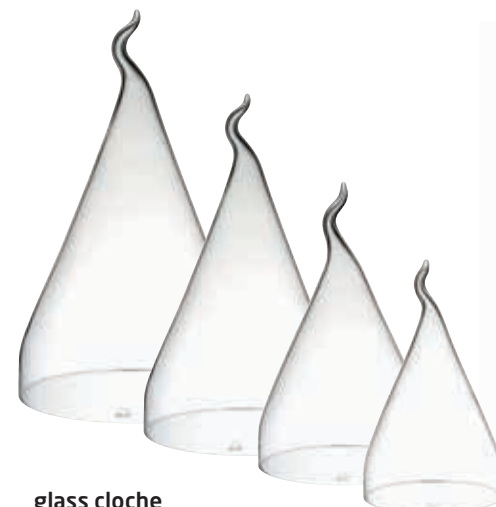

glass cloche

borosilicate glass, transparent, handblown, handmade, for coaster "Solid" items 4734...

item	Ø in cm	height in cm
4880.18	18.5	approx. 29-32
4880.22	22.5	approx. 35-38
4880.26	26	approx. 41-44
4880.30	30	approx. 48-51



coaster/glass insert

hardened clear glass, 4 mm thick, round, edge polished and deburred, with 4 transparent silicone feet

item	Ø in cm
5244.17	16.7
5244.21	20.7
5244.24	24.2
5244.28	28.2



coaster "Solid"

walnut, food-safe sealed, not dishwasher-safe, stackable, for glass cloche items 4850, 4851, 4852 and 4880... and glass inserts items 5244...

item	Ø / height in cm	for cloche / insert
4734.01	23 / 3	Ø 18.5 / 16.7 cm
4734.02	27 / 3	Ø 22.5 / 20.7 cm
4734.03	30.5 / 3	Ø 26 / 24.2 cm
4734.04	34.5 / 3	Ø 30 / 28.2 cm



cloche with wooden coaster and glass insert

set consists of:

cloche made of borosilicate glass

insert made of hardened transparent glass (4 mm thick)

saucer made of walnut

1 set in black gift box

item	Ø in cm	height in cm	PU
4882.22PB	27	approx. 37-40	1 set (3 parts) 📦
4882.30PB	34.5	approx. 50-53	1 set (3 parts) 📦

Cloches made of borosilicate glass are heat resistant, dishwasher-safe and very easy to handle for the guests. The main features of this material are a great resistance against heat and changes in temperature as well as a high breaking strength. Each item is manufactured by hand and therefore shaped individually.



The cloches "Cuspis" are available on page 178.



The cutting board is available on page 110.



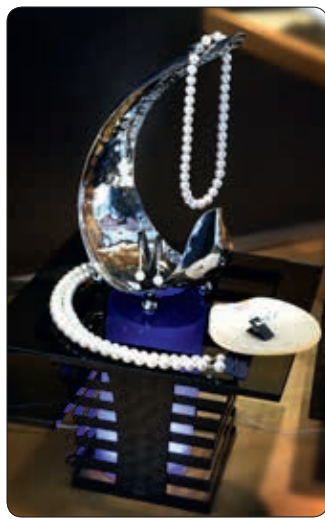

The buffet systems by Zieher were developed to put the most exquisite products into the limelight in a very effective and diversified way.



The section "displays" shows that they are not limited to the use with food: high-class jewellery and watches, as well as other kinds of luxury goods find a representative stage with the Zieher display systems.

The discreet and classy design never pushes for attention but offers a unique and distinctive means of presentation that puts the product at the centre of attention.

Contact: display@zieher.com



Photo: www.juwelier-hohenberger.de

Catering



NEW

"Bento Box"



insert / box

melamine, black, surface matt, stackable, food-safe, dishwasher-safe, not suitable for microwave and combi steam oven, up to 4 pieces suitable for item 4578

item	l x w x h in cm	PU
4580	29.5x9x3.3	3 pcs



Available in different colours from 350 sets (box + lid) upon request!



The champagne flute "Vaganza" is available on page 202.



The lid of the Zieher bento box can also be used as a shapely tray.



lid / tray

melamine, black, surface matt, stackable, food-safe, dishwasher-safe, not suitable for microwave and combi steam oven, with ventilation slots, suitable for item 4578, also usable as a tray

item	l x w x h in cm
4579	39.5x31.5x4



bento box

melamine, black, surface matt, stackable, food-safe, dishwasher-safe, not suitable for microwave and combi steam oven, partition for cutlery/napkin/inserts (28 cm x 7.5 cm) or for platters (28 cm x 28 cm)

item	l x w x h in cm
4578	39x30.5x8.5

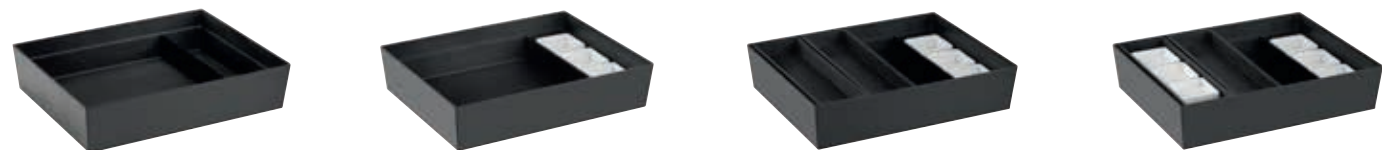

Suitable inserts made of glass and china (7 cm x 7 cm) are available on page 272.

"Bento Box"

NEW



"Bento Box" - flexible mobility

Serving guests at the pool, beach or on the terrace is often associated with longer walking distances for the service staff. The „Bento Box“ from Zieher has been designed especially for these requirements – all components are stackable. This way they guarantee a space-saving storage and a comfortable, non-slip transport, even with several dishes at the same time.

Matt black melamine, modern design and subtle contrasts created by different surface structures, form the perfect setting for individual creations and popular classics such as burgers, club sandwiches or salads.

The box is divided into a main compartment for plates up to a diameter of 28 cm and a narrow side compartment for cutlery and napkin or miniatures made of glass and porcelain.



The coup plate "Catering" is available on page 164, the inserts on page 272.

Optionally available inserts in the same design create additional space for side dishes, sauces or dips, when placed above the cutlery compartment. Up to four of these bowls can be placed in a bento box if required, and, with a correspondingly flat content of the main compartment, create a second level for even more flexibility.

The versatility of the individual components also becomes evident in the cover, which has decorative ventilation slots to dissipate steam generated by hot food. This lid can also be used as a tray, whose less finely textured inside has an anti-slip effect.

Box, insert bowl and lid are sold separately and can be combined as desired. This allows the restaurateur the adaption to his individual needs and helps to optimize additional purchases.



Melamine!

- Modern design with matt-black surface
- Dishwasher-safe
- Food-safe
- Odourless
- Easy-care



Real added value is provided by different boxes made from the same material. They are available as an insert for the bento box (page 120) and as a cutlery box in two sizes. In addition, three smaller variants have been developed, paying particular attention to the greatest possible compatibility with the trays. The boxes can be arranged in a variety of combinations on all melamine trays and thus offer enormous potential for a use at the Flying Buffet, in catering, at the bar or at the breakfast buffet. A selection of suitable combinations is available on the following pages.

The sturdy containers can also be used as plain elevations for platters and trays. Without additional efforts in procuring material, it is possible to arrange varied buffet presentations quickly and easily. Additionally available are different versions with three round or oval cavities. A big selection of suitable inserts made of glass or porcelain is available on page 274 and 275.

The spoon rest made of melamine is available on page 126, suitable spoons and skewers on pages 136 and 137.



bowl/box

melamine, black, surface matt, food-safe, dishwasher-safe, not suitable for microwave and combi steam oven

item	l x w x h in cm	PU
4598.09	9x6.3x4.5	6 pcs
4598.13	12.8x9x4.5	4 pcs



bowl/box

melamine, black, surface matt, food-safe, dishwasher-safe, not suitable for microwave and combi steam oven

item	l x w x h in cm	PU
4599.13	12.8x12.8x4.5	4 pcs



insert/box

melamine, black, surface matt, stackable, food-safe, dishwasher-safe, not suitable for microwave and combi steam oven, up to 4 pieces suitable for item 4578

item	l x w x h in cm	PU
4580	29.5x9x3.3	3 pcs



cutlery/napkin box

melamine, black, surface matt, food-safe, dishwasher-safe, with 4 rubber feet, not suitable for microwave and combi steam oven, for cocktail napkins folded to 1/8

item	l x w x h in cm	content in l	PU
4591	16x6x4.5	0.26	2 pcs



cutlery box

melamine, black, surface matt, food-safe, dishwasher-safe, not suitable for microwave and combi steam oven, for cutlery with a length of up to 23.5 cm

item	l x w x h in cm	PU
4594	26.5x16.2x7.2	4 pcs

Melamine!



tray

melamine, black, surface matt, food-safe, dishwasher-safe, not suitable for microwave and combi steam oven

item	l x w x h in cm	PU
4586	25.2x13.2x1.8	2 pcs



GN tray

melamine, black, surface matt, food-safe, dishwasher-safe, not suitable for microwave and combi steam oven

item	l x w x h in cm	GN	PU
4587	32.5x17.6x1.8	1/3	2 pcs
4588	32.5x26.5x1.8	1/2	2 pcs
4589	53x32.5x1.8	1/1	2 pcs

The "Modul" base trays made of walnut are available on page 132 and 133, suitable inserts made of glass and china on pages 134 to 138.



base tray "Modul"

melamine, black, surface matt, food-safe, dishwasher-safe, not suitable for microwave and combi steam oven

item	l x w x h in cm	PU
4581	53x28x1.8	2 pcs
4582	72.5x28x1.8	2 pcs
4583	95.5x28x1.8	2 pcs

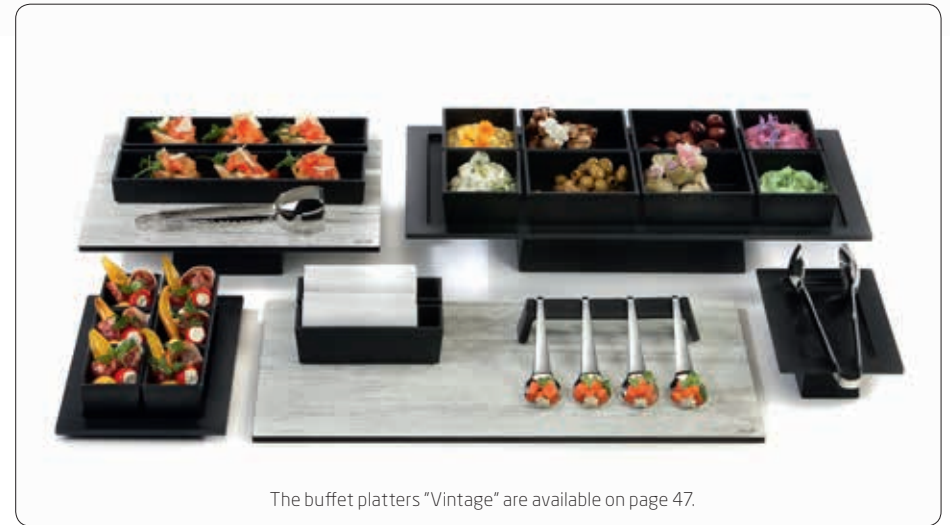

The buffet platters "Vintage" are available on page 47.

Robust and elegant - melamine!

The advantages of melamine such as dishwasher-resistance and food-safety are particularly evident in daily catering use.

The matt black surface of the Zieher melamine articles generates a superb contrast to glass and porcelain and impresses by its pleasant haptics.

Modern design and the simple language of form of the trays, which are available in common GN formats, make up a pleasant addition to the articles of the "Modul" series (page 134). The bridges and spoon rests (page 126) can be used on all the trays, non-skid rubber feet on the bottom side facilitate the service enormously.

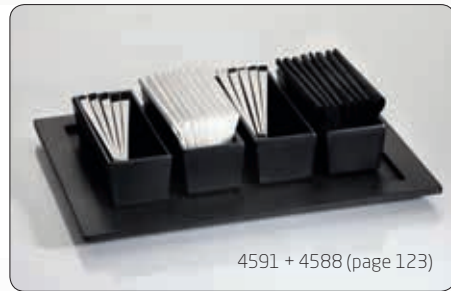

The boxes can be arranged in a variety of combinations on all melamine trays and thus offer enormous potential for a use at the Flying Buffet, in catering, at the bar or at the breakfast buffet. A small range of possible combinations is shown here, all melamine trays and inserts shown on this double-page are available on page 122 and 123.



Robust & elegant - melamine!



Inserts made of glass and china, suitable for item 4590, are available on page 275.



2/8 GN tray

melamine, black, surface matt, food-safe, dishwasher-safe, not suitable for microwave and combi steam oven, with 3 round sockets (Ø 5.5 cm / 8.2 cm)

item	l x w x h in cm	PU
4590	32.5x13.2x1.8	2 pcs



glass bowl

clear glass, oval

item	l x w x h in cm	content in l	PU
5444	12.5x7x4	0.08	6 pcs



bowl

china, white, oval

item	l x w x h in cm	content in l	PU
4081.12	12.5x7.5x4	0.1	12 pcs



tray

melamine, black, surface matt, food-safe, dishwasher-safe, not suitable for microwave and combi steam oven, with 3 oval sockets (diagonal), for small bowls items 4081.12 (china) and 5444 (glass)

item	l x w x h in cm	PU
4593	32.5x13.2x1.8	2 pcs



4593 + 4081.12



4593 + 5444



The trays of the "Modul" series and suitable inserts made of glass and china are available on pages 134 to 138.

The party spoons items 1938... are available on page 136.



bridge "Modul"

melamine, black, surface matt, food-safe, dishwasher-safe, not suitable for microwave and combi steam oven, 5 graded sockets (Ø top 5 cm, Ø bottom 2.5 cm), for several glass items (5257, 5405,...), with 4 rubber feet (black)

item	l x w x h in cm	PU
4584	41.5x7.7x6	2 pcs



spoon rest "Modul"

melamine, black, surface matt, food-safe, dishwasher-safe, not suitable for microwave and combi steam oven, with 4 rubber feet (black)

item	l x w x h in cm	PU
4585	20x5x4	2 pcs

Further trays made of walnut are available on pages 104 to 114.



serving tray "Solid"

walnut, food-safe sealed, not dishwasher-safe, stackable, 2 compartments: 30 cm x 30 cm and 30 cm x 8 cm (for cutlery or china/glass bowls), with 4 rubber feet

item	l x w x h in cm
4769	41.7x32.5x6.7



cutlery box "Solid"

walnut, food-safe sealed, not dishwasher-safe, with acrylic glass lid, with 4 rubber feet, for cutlery with a length of up to 24.3 cm

item	l x w x h in cm
4720	26.5x16.2x8

The cutlery/napkin box for the table is available on page 247.



More information about the serving tray "Solid" is available on page 244.



The cutlery boxes item 4720 (wood) and 4594 (melamine) are stackable in all commercial transport boxes in format 60 cm x 40 cm.

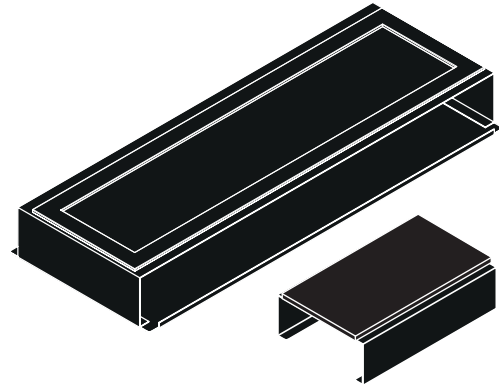

livecookintable Zieher displays:
 livecookintable food bridge + display, suitable for Zieher tray and china series "Modul" (pages 131 to 139).



livecookintable® multistation:
 With the livecookintable® multistation a versatile product has been developed. It is suitable for the combined use with the product series "Solid" (pages 108 to 110), "Modul" (pages 131 to 138) as well as with the melamine trays (pages 122 and 123) by Zieher. Whether it is used to shelve china, to serve coffee, tea or bread or as a cutting station, this multistation and Zieher offer an unlimited multitude of possibilities.



Zieher and livecookintable® have started a cooperation for the "Modul" series (pages 131 to 139), the catering system by Zieher. Livecookintable® has developed fitting displays to integrate "Modul" perfectly into this innovative table system and to maximise the advantages of both product lines.



Here you can download the Augmented Reality App!
 Configure your livecookintable® solutions directly in your premises.



All about the livecookintable® system is available on www.livecookintable.com

"Slope"



4595.30

The melamine tray "Slope" is characterised by its unobtrusive shaping and the pleasant feel of the matt, finely structured surface. An elevated corner and the resultant asymmetry award the tray that certain something.

Besides the obvious function as a service tray for espresso, cocktails, snacks and more it also performs well in the hotel bathroom or as a decorative trivet in the hotel room.

"Slope" is available in a black and a white version and in two sizes. The robust raw material melamine appears very elegant due to its matt surface and of course it complies with demands of everyday use like food safety, dishwasher resistance as well as stackability.



Design: Wilma Greim

4596.45

VISION from page 194 onwards



tray "Slope"

melamine, matt, rectangular (oblique), stackable, utility space: approx. 26 cm x 15.5 cm

item	colour	l x w x h in cm	PU
4595.30	black	30x19.5x4.2	3 pcs
4596.30	white	30x19.5x4.2	3 pcs





tray "Slope"

melamine, matt, rectangular (oblique), stackable, utility space: approx. 40 cm x 24 cm

item	colour	l x w x h in cm	PU
4595.45	black	45x29x4.2	2 pcs
4596.45	white	45x29x4.2	2 pcs

tray "Slope"

in black gift box

item	colour	l x w x h in cm	PU
4595.45PB	black	45x29x4.2	1 pc. 
4596.45PB	white	45x29x4.2	1 pc. 

"Modul"



"Modul" is a flexible product ready for "Flying Buffet" service - and therefore ideally suited for use in the catering area. The slim, oblong format of the base tray, which is available in three sizes, renders the often cumbersome service at crowded standing receptions barrier-free and uncomplicated. The trays can be variably fitted with glass or porcelain parts, a bridge for glasses or a spoon bench for 4 spoons. When using two spoon benches together, 4 long skewers can be placed safely on top. Every single piece has been specially developed for this catering system. Trays, bridge and spoon rest are available in 2 variations: The series "Modul" is manufactured from walnut wood, which is probably the most precious of all European hardwoods (pages 132 and 133) and from melamine in a modern matt-black design (pages 134 and 135). Suitable miniatures made of china and glass (pages 136 to 138) can be fitted to all trays! Shapely anti-slip mats made of silicone (page 139) facilitate catering to a great extent.

Play upon a variety of possibilities!

"Modul" - walnut

Wood from the European walnut tree, which is one of the most precious and most beautiful types of wood, forms the basis for this series. Both the wood's warm brown colours in different shades and its intensive and distinctive grain make every product a unique item. The high-quality workmanship in combination with the food-safe sealing guarantees long durability, even in every-day use.



The party spoon items 1938... are available on page 233.



Suitable inserts for the bridge "Modul" are available on page 138.



base tray "Modul"

walnut, food-safe sealed, not dishwasher-safe, stackable

item	l x w x h in cm
4721	47.5x25.5x3.1
4722	70x25.5x3.1
4723	92.5x25.5x3.1



The finger-groove on the bottom side of the tray guarantees safe and simple handling.



bridge "Modul"

walnut, food-safe sealed, not dishwasher-safe, with 5 graded sockets (Ø top 5 cm, Ø bottom 2.5 cm), with 4 rubber feet

item	l x w x h in cm
4724	42,5x9x6,5



spoon rest "Modul"

walnut, food-safe sealed, not dishwasher-safe, with 4 rubber feet

item	l x w x h in cm
4725	21x3,2x3,8



buffet display "Solid"

walnut, food-safe sealed, not dishwasher-safe, bottom side open, can be used as a stand or as a container

item	l x w x h in cm	PU
4767.12	12x12x12	2 pcs
4767.24	12x12x24	2 pcs

"Modul" - walnut



- European walnut
- Warm shades of brown with vivid grain
- High-quality workmanship
- Finger-groove on the bottom side guarantees safe and simple handling



The buffet stands "Antique" are available on page 38. More items made of walnut are available on pages 102 to 117 and 244 to 255.

“Modul” - melamine

The advantages of melamine are manifold. It is dishwasher-safe and food-safe, which becomes evident in daily catering use! The smallest tray is 53 cm long and is therefore partially compatible with existing GN-systems. All trays are stackable.

Besides the merely technical properties, the flat black trays differ from the variant made of walnut by their modest design and modern appearance.

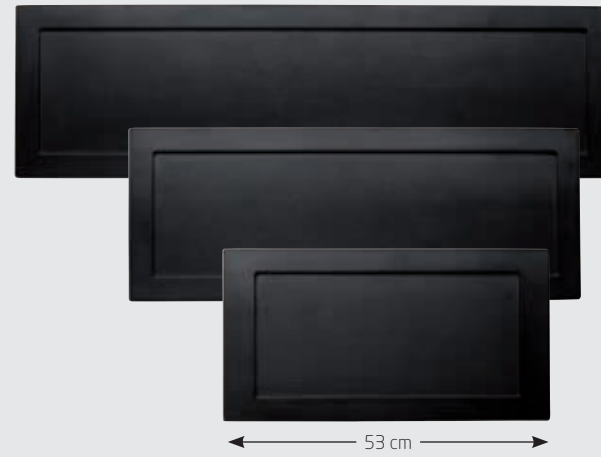

base tray “Modul”

melamine, black, surface matt, food-safe, dishwasher-safe, not suitable for microwave and combi steam oven

item	l x w x h in cm	PU
4581	53x28x1.8	2 pcs
4582	72.5x28x1.8	2 pcs
4583	95.5x28x1.8	2 pcs



The grooves at the bottom side of the tray let water from the dishwasher run off.



bridge “Modul”

melamine, black, surface matt, food-safe, dishwasher-safe, not suitable for microwave and combi steam oven, 5 graded sockets (Ø top 5 cm, Ø bottom 2.5 cm), for several glass items (5257, 5405,...), with 4 rubber feet (black)

item	l x w x h in cm	PU
4584	41.5x77x6	2 pcs



spoon rest “Modul”

melamine, black, surface matt, food-safe, dishwasher-safe, not suitable for microwave and combi steam oven, with 4 rubber feet (black)

item	l x w x h in cm	PU
4585	20x5x4	2 pcs

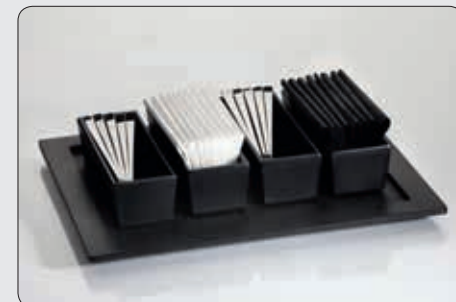

The bowl “Modul” is available on page 136.



The skewers 1939.02 are available on page 137.



The party spoon items 1938... are available on page 136.



Suitable inserts for the bridge are available on page 138.

“Modul” - melamine

- Modern design with matt-black surface
- Dishwasher-safe
- Food-safe
- Odourless
- Easy-care



The buffet stands “Lightning Buffet” are available on page 40.



walnut

bowl “Modul”

china, white, rectangular, deep, for base trays “Modul” made of walnut and melamine

item	l x w in cm	content in l	PU
4384	22x11	0,22	12 pcs



walnut

bowl “Modul”

china, white, square, deep, for base trays “Modul” made of walnut and melamine

item	l x w in cm	content in l	PU
4381	11x11	0,07	12 pcs



walnut

plate “Modul”

china, white, square, flat, for base trays “Modul” made of walnut and melamine

item	l x w in cm	PU
4380	11x11	12 pcs

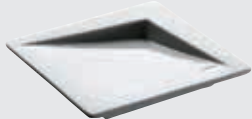

walnut

plate “Modul”

china, white, flat, item 4385.22 fits base trays “Modul” made of walnut and melamine

item	l x w in cm	PU
4385.22	22x22	6 pcs
4385.27	27x27	4 pcs



party spoon

stainless steel 18/10, 4.3 mm thick, heavy quality, 21 cm long

item	version
1938	polished
1938.01	hammered finish

walnut

“Modul” - versions

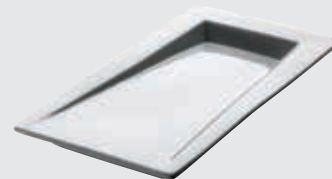
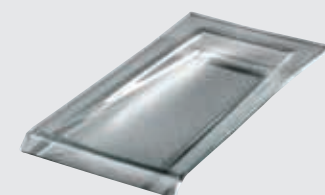

plate “Modul”

china, white, rectangular, flat, for base trays “Modul” made of walnut and melamine

item	l x w in cm	PU
4383	22x11	12 pcs



glass plate “Modul”

glass, transparent, structured, rectangular, flat, for base trays “Modul” made of walnut and melamine

item	l x w in cm	PU
5074.01	22.5x11	6 pcs



amuse-gueule/tapas spoon “Modul”

china, white

item	l x w in cm	PU
4260.03	10x4x2.2	12 pcs



spoon rest “Modul”

melamine, black, surface matt, food-safe, dishwasher-safe, not suitable for microwave and combi steam oven, with 4 rubber feet (black)

item	l x w x h in cm	PU
4585	20x5x4	2 pcs



skewer “Flame”

stainless steel 18/10, polished

item	length in cm	PU
1939.02	24	12 pcs



cutlery/napkin box

melamine, black, surface matt, food-safe, dishwasher-safe, with 4 rubber feet, not suitable for microwave and combi steam oven, for cocktail napkins folded to 1/8

item	l x w x h in cm	content in l	PU
4591	16x6x4.5	0.26	2 pcs



melamine

melamine

The amuse gueule/tapas spoon item 4260.01 is available on page 235.

melamine with non-slip mat (page 139)

melamine



walnut with non-slip mat (page 139)

The "Modul" base trays made of walnut and melamine combine well with many Zieher items from the same series and beyond. Here are some suggestions:



small bowl
china, white, square

item	l x w x h in cm	content in l	PU
3853	7x7x2	0.05	12 pcs



dip bowl for olive oil
china, white

item	l x w x h in cm	PU
3912	12x12x1.8	6 pcs



small bowl
square, 4.9 cm long, 4.9 cm wide, 4.5 cm high, 0.05 l content

item	version	PU
3845	china	4 pcs
5254	clear glass	4 pcs



walnut



miniature platter
china, white

item	l x w in cm	PU
4072.M	13x6	12 pcs



glass bowl
borosilicate glass, flat

item	Ø / height in cm	content in l	PU
4910	10.5 / 2.5	0.18	12 pcs



glass
transparent, for bridges "Modul" items 4584 and 4724

item	Ø / height in cm	content in l	PU
5405	5 / 8.6	0.1	6 pcs



glass miniature
clear glass, for bridges "Modul" items 4584 and 4724

item	Ø / height in cm	content in l	PU
5257	7 / 10	0.08	12 pcs



glass miniature
clear glass, wavy rim, base: 0.07 l content, top part: 0.04 l content, for bridge "Modul" items 4584 and 4724

item	version	Ø / height in cm	PU
5423.01	base	6.5 / 5.5	12 pcs
5423.02	top	6.3 / 4.5	12 pcs



test tube
borosilicate glass (temperature change resistant), with flanged rim and round bottom, for holder for test tube items 4680... and cork item 1501

item	Ø / height in cm	content in l	PU
4032.G	2 / 15	0.04	24 pcs

cork
for test tube item 4032.G

item	Ø in cm	length in cm	PU
1501	2.0/1.7	2.6	24 pcs

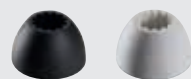

holder for test tubes
silicone, Ø 4.6 cm, 2.7 cm high, with grooves on the inside for easy insertion of glass tubes, for test tube item 4032.G

item	colour	PU
4680.S	black	6 pcs
4680.W	white	6 pcs

Non-slip covers in matt black: Classy look - great benefit!



The matt black look and velvety texture of these mats create an interesting contrast when used in connection with the trays made of walnut. In combination with the "Modul" melamine trays they become almost invisible.

The mats made of food-safe silicone are extremely skid-proof and facilitate the serving considerably. No clattering, no shifting of porcelain bothers guests and staff!

To clean the mats, please use a moist cloth with some detergent and wipe off with a cloth and clear water.



Non-slip coasters for single miniatures are available on page 210.



The sizes of the mats perfectly fit the walnut trays items 4721, 4722 and 4723. The mats can be adjusted in size with a sharp cutter knife, to fit the same sized melamine trays items 4581, 4582 and 4583. We recommend the use of a cutting board and a steel ruler.

non-slip mat
silicone, black, food-safe, temperature resistant (-40 °C - +230 °C), for walnut trays "Modul" items 4721, 4722 and 4723, can be cut to fit melamine trays "Modul" items 4581, 4582 and 4583

item	l x w in cm	PU
4660.01	42.6x20.6	6 pcs
4660.02	65.5x20.6	6 pcs
4660.03	87.6x20.6	6 pcs



New

"Pulsar"



"Pulsar" - Sparking Impulses!

This gourmet plate, predestined for appetizers, intermediate courses or desserts, excels through its exceptional shape and thrills the beholder by the exotic touch it has been awarded by its designers.

The surface is reminiscent of the playful waves created on a smooth lake after a stone's throw. The viewer's gaze purposefully wanders to the centre of the concentric design and this way the served dishes come straight to the fore. Be it for selectively arranged sauces or dips, crunchy crisp caramelized nuts or edible flowers, even the wave troughs of the plate's rim offer numerous possibilities to stage dishes effectively. "Pulsar" is made of high-quality hard porcelain in a surprisingly soft composition and is available glazed in glossy white or in matt black.

The fitting cloches are based on the extraordinary design of the "Nostalgic" glasses from the VISION series. The language of design of the wine glasses recurs in the cloches that are mouth-blown as well - the perfect combination for a balanced and harmonic staging on the table. These exclusive covers are available in two sizes. The small version precisely spans the inner circle, the bigger one additionally covers the first wave.



The wine glass series VISION is available from page 194.

Design: Grace Liu, Jian Ping Li



glass cloche
crystalline glass, transparent, handblown, for a utility space of Ø 9.5 cm or Ø 14.5 cm respectively

item	Ø in cm	height in cm	PU
5482.10	10.5	13	2 pcs
5482.15	15.5	19.5	1 pc

glass cloche
in black gift box

item	Ø in cm	height in cm	PU
5482.10PB	10.5	13	1 pc



4507.01PB + 5482.15



plate/platter "Pulsar"
china, white, Ø inside 10.5 cm, suitable for cloche 5482.10 and 5482.15 in black gift box

item	Ø in cm	PU
4507.01PB	29.5	1 pc



4507.02PB + 5482.10



plate/platter "Pulsar"
china, black, matt, Ø inside 10.5 cm, suitable for cloche 5482.10 and 5482.15 in black gift box

item	Ø in cm	PU
4507.02PB	29.5	1 pc

China, glass and more!



"Pulsar"



glass cloche “Cuspis”
borosilicate glass, transparent, handblown, star-shaped ball handle

item	for plate/bowl	Ø in cm	height in cm
4940.08	4389.09	8.5	12.5
4940.10	4389.11	10.5	14.5
4940.25	4389.25PB	25	32.5



plateau plate/small bowl “Cuspis”
china, white, inside and useable area (plateau Ø approx. 6 cm/8 cm) glazed, outside biscuit, also useable as a bowl

item	Ø in cm	height in cm	content in l
4389.09	9	3	0.1
4389.11	11.5	3.5	0.18



plateau plate/bowl “Cuspis”
china, white, inside and useable area glazed, outside biscuit, useable on both sides, for cloches items 4940.25 and 4940.10 (bottom side), in black gift box

item	Ø in cm	height in cm	content in l
4389.25PB	25	2.8	0.8



**cloche with plateau plate/
small bowl “Cuspis”**
set consists of:
cloche made of borosilicate glass, transparent, handblown, with star-shaped ball handle
plateau plate made of white china, inside and useable area glazed, outside biscuit, useable on both sides
1 set in black gift box

item	Ø in cm	height in cm	PU
4943.08PB	9	approx. 14/14.5	1 set (2 parts)
4943.10PB	11.5	approx. 17/17.5	1 set (2 parts)
4943.25PB	25	approx. 33/35	1 set (2 parts)

Borosilicate glass in its most beautiful shape!

The primary design element of the series “Cuspis” is a glass ball studied with fine spikes. The cloches with fitting porcelain plateau plates/ bowls are available in three sizes and the inspiration for their shaping was derived from the nut of the oak tree. The star-shaped handle is located at the top of the cloches and allows for an uncomplicated handling of these classy covers. The unglazed outside of the porcelain bowls is reminiscent of acorn caps. The bowls can be used on both sides. When used as a plateau plate, the dish moves closer to the guest. Used as a bowl, it offers space for gravies, sauces and more while the filigree glass cloche protects the presented delicacies and puts them in the limelight at the same time. Shapely amuse-gueule spoons as well as an extraordinary honey spoon, which can also be used as askewer, complete the “Cuspis” series. These items are available on page 204.



The honey spoon “Cuspis”, here used as a skewer, is available on page 204.



The dark grey glass platters are available on page 57, the glass spoon “Cuspis” on page 204.



If the item is used upside down as a plate, the two rings on the plate’s underside can be used to separate the prepared dish into different sections and the cloches of the “Cuspis” series may also be used with it (4940.10 on the inner ring, 4940.25 on the outer ring).



4389.25PB + 4940.10

“Donna”

Bedded on china,



These elegant porcelain-pillows “Donna”, which are inspired by a woman’s curved back, are definitely not made to sleep on but offer an ideal presentation area for high-end dishes or present a sculptural place to keep various items of everyday life. Even when used as a soap dish, the medium pillow made of glass or porcelain cuts a fine figure. The version made of porcelain is available in three sizes and stages every dish and surprises the guest. Especially the two small pillows can be used perfectly on the buffet and offer an exciting contrast to conventional forms of glass or china.

Platters and charger plates made of hardened black glass are available on page 50.



porcelain pillow “Donna”
white, items 4461.02 and 4461.02PB:
not dishwasher-safe

item	l x w x h in cm	PU
4461.03	12.3x8x2.7	12 pcs
4461.01	16.5x11x3.5	6 pcs
4461.02	33x22x7	1 pc.

porcelain pillow “Donna”
in black gift box

item	l x w x h in cm	PU
4461.01PB	16.5x11x3.5	1 pc.
4461.02PB	33x22x7	1 pc.

glass or wood!



glass pillow “Donna”
glass, satined, in black gift box

item	l x w x h in cm
5446.01PB	16.5x11x3



wooden pillow “Donna”

solid walnut, oiled, not dishwasher-safe, 4 rubber feet, in black gift box

item	l x w x h in cm
4772.33PB	33.5x22.5x7

“Donna”



The variants of the “Donna” pillows are made of frosted glass and oiled walnut and despite their hard and massive raw materials they surprise by their pleasantly soft and velvety feel. One just has to touch the softly curved forms of this hand charmer. The version made of solid walnut, one of the finest European types of wood, has its own appearance. The sealing with oils emphasizes the striking grain of the wood and gives the surface a silk-matt gloss as well as amazing haptics. Whether used as a fruit bowl, as a place to keep accessories or as sculptural decoration - “Donna” seduces in every material!



NEW

"Unique"

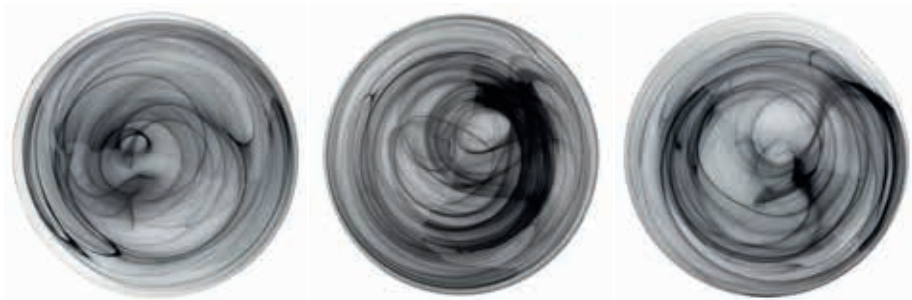

"Unique" is produced in centrifugal casting. Besides the individual decor this production method entails a slight variation of size, strength and shape of the items. That's exactly what awards these unique pieces their special charm.



glass plate "Unique"

glass, white marbled, bottom satined, round

item	Ø in cm	PU
5178.16	16,5	6 pcs
5178.21	21	6 pcs
5178.28	28	6 pcs
5178.32	32	3 pcs



glass bowl "Unique"

glass, white marbled, outside satined, round

item	Ø in cm	height in cm	content in l	VPE
5180.10	10	6	approx. 0.2	6 pcs
5180.15	14,5	7,5	approx. 0.65	6 pcs



glass bowl "Unique"

glass, white marbled, outside satined, round

item	Ø in cm	height in cm	content in l	PU
5182.16	16	5	approx. 0.67	6 pcs
5182.21	21	8	approx. 2.0	4 pcs
5182.27	26,5	8	approx. 2.75	4 pcs

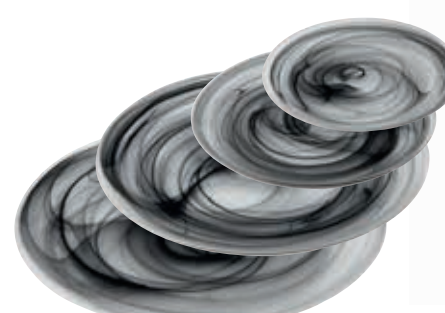

glass plate "Unique"

glass, black marbled, bottom satined, round

item	Ø in cm	PU
5179.16	16,5	6 pcs
5179.21	21	6 pcs
5179.28	28	6 pcs
5179.32	32	3 pcs



glass bowl "Unique"

glass, black marbled, outside satined, round

item	Ø in cm	height in cm	content in l	PU
5181.10	10	6	approx. 0.2	6 pcs
5181.15	14,5	7,5	approx. 0.65	6 pcs



glass bowl "Unique"

glass, black marbled, outside satined, round

item	Ø in cm	height in cm	content in l	PU
5183.16	16	5	approx. 0.67	6 pcs
5183.21	21	8	approx. 2.0	4 pcs
5183.27	26,5	8	approx. 2.75	4 pcs

"Unique"

NEW



The plates and bowls of the "Unique" series are made of clear glass which is awarded an inimitable character by adding black and white glass components. This creates individual streaks and swirls which assemble to highly exciting patterns.

All items of this series are available in black or white. The underside of the plates as well as the outside of the bowls are blasted which results in satined optics and pleasant haptics.

With the black imbued versions this refinement intensifies the contrast; with the white ones it appears more restrained by the matting of the backside - the decor retracts in an unobtrusive way. "Unique" presents - in shape and decor - a real counterpart to the uniform character of industrially manufactured mass products and proves to be as unique as its users.



The etageres "DressCoat" are available on page 77.
Assembly:
2x 5179.21 + 1x 5179.28



plateau plate "DressCoat"

china, white, useable area (plateau): Ø 6.5 cm, also useable as a bowl

item	Ø / height in cm	content in l	PU
4386.02	8 / 4	0.09	12 pcs

plateau plate "DressCoat"

china, white, useable area (plateau): Ø 7.5 cm, also useable as a bowl

item	Ø / height in cm	content in l	PU
4386.01	9 / 4.5	0.1	12 pcs



plateau plate "DressCoat"

china, white, useable area (plateau): Ø 10.5 cm, also useable as a bowl

item	Ø / height in cm	content in l	PU
4386	13 / 6.5	0.4	6 pcs

plateau plate "DressCoat"

in black gift box

item	Ø / height in cm	content in l	PU
4386.PB	13 / 6.5	0.4	1 pc.



plateau plate "DressCoat"

white china, useable area (plateau): Ø 15 cm, also useable as a bowl

item	Ø / height in cm	content in l	PU
4387	17 / 8.5	0.85	3 pcs

plateau plate "DressCoat"

in black gift box

item	Ø / height in cm	content in l	PU
4387.PB	17 / 8.5	0.85	1 pc.



plateau plate "DressCoat"

white china, useable area (plateau): Ø 19.5 cm, also useable as a bowl

item	Ø / height in cm	content in l	PU
4388	22 / 6.5	0.9	3 pcs

plateau plate "DressCoat"

in black gift box

item	Ø / height in cm	content in l	PU
4388.PB	22 / 6.5	0.9	1 pc.

"DressCoat"



"DressCoat" was created by the glass and porcelain designer Nadine Podewski. The elegant language of design is reminiscent of set tables, the creation of the plates and bowls respectively is characterised by the apparently free falling drapery of table cloth. This creates a seemingly weightless, almost floating effect. The slightly concave shaped surface offers space for artfully decorated dishes and reliably avoids the sloshing of sauce.

"DressCoat" is available in five different sizes. Besides the main application as a plateau plate each item can also be used as a bowl. The falling folds add up to an exciting game of shapes - in particular if used as a bowl.

With "DressCoat" you will dish up delicacies!



The etagere item 2213.30 is available on page 77.

Food: Pâtisserie Walter
(www.patisserie.de)



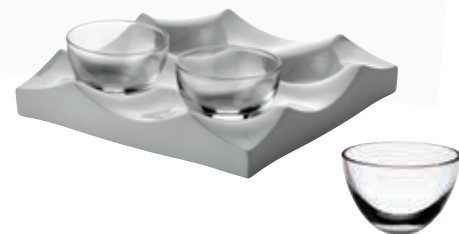

small glass bowl/cloche
clear glass, handblown, for platter "Collina" item 4503

item	Ø / height in cm	content in l	PU
5418	9 / 6	0.2	6 pcs



glass
clear glass, for platter "Collina" item 4504

item	Ø / height in cm	content in l	PU
5380	7.5 / 10.5	0.32	6 pcs
5381	7.5 / 6	0.18	6 pcs

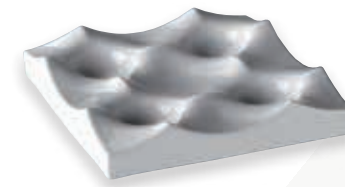

platter "Collina"
china, white, not dishwasher-safe, with 4 deepenings, with 4 rubber feet (enclosed in the pack)

item	l x w x h in cm
4503	24.5x24.5x4.5

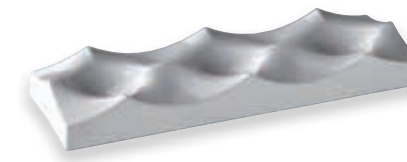

platter "Collina"
china, white, not dishwasher-safe, with 3 deepenings, with 4 rubber feet (enclosed in the pack)

item	l x w x h in cm
4504	36.5x12.5x4.5

platter "Collina"
in black gift box

item	l x w x h in cm
4504.PB	36.5x12.5x4.5

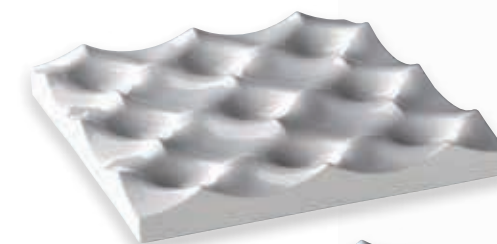

platter "Collina"
china, white, not dishwasher-safe, with 9 deepenings, with 4 rubber feet (enclosed in the pack)

item	l x w x h in cm
4501	36.5x36.5x4.5
4502	26x26x3.2

platter "Collina"
in black gift box

item	l x w x h in cm
4501.PB	36.5x36.5x4.5



"Collina" provides almost unlimited possibilities. Whether in the lobby or on the buffet, for the presentation of fruit and pastry or as an exclusively decorative element, this series is versatile. The smaller version of the plate, which is divided into nine parts, is perfectly suitable for various antipasti and delicacies from the patisserie. A selection of fruit can be put in the limelight beautifully by using platters with either three or four deepenings.

The possibilities when considering private use are numerous, too. "Collina" may be used as a fruit bowl, but it is also suitable as a means to neatly organize objects of everyday life, such as the mobile phone or keys.

In order to protect the sensitive surfaces of furniture, every plate comes with feet made of rubber, which can be stuck on if needed. The rigorously geometrical structure permits the assembling of several plates which allows to enlarge the effective area of the platters in both length and width. When looking at the surface from the side, the arrangement has the appearance of a desert landscape arbitrarily formed by the wind.





fruit/dessert bowl "Spobo"

china, white, with spoon rest, for spoons with a total length of 15 cm and over

item	Ø / height in cm	content in l	PU
4230.14	14 / 5	0.18	6 pcs

fruit/dessert bowl "Spobo"

china, white, with spoon rest, for spoons with a total length of 15 cm and over, in black gift box

item	Ø / height in cm	content in l	PU
4230.14PB	14 / 5	0.18	1 pc.



soup bowl "Spobo"

china, white, with spoon rest, for spoons with a total length of 20 cm and over

item	Ø / height in cm	content in l	PU
4230.18	18.5 / 6.5	0.42	3 pcs

soup bowl "Spobo"

china, white, with spoon rest, for spoons with a total length of 20 cm and over, in black gift box

item	Ø / height in cm	content in l	PU
4230.18PB	18.5 / 6.5	0.42	1 pc.



The black glass trays are available on page 276.



1938, polished



1938.01, hammered

spoon recommendation

for soup bowl "Spobo" item 4230.18 and 4230.18PB

item	length in cm	PU
1938	party spoon, polished	1 pc.
1938.01	party spoon, hammered finish	1 pc.

Innovative porcelain ...



... for a creative gastronomy!



small glass bowl "Spobo" with spoon rest

clear glass, for spoons with a total length of 12 cm and over

item	Ø / height in cm	content in l	PU
5440	10 / 4	0.08	6 pcs

Whether it is a nutritious breakfast, cereals or an amazing gazpacho – "Spobo" offers a variety of possibilities. Allowing a spoon or fork to be rested on the rim of the bowl, "Spobo" stands for effortless and uncomplicated handling, even in daily use and surprises by its innovative look.

"Dots"



plate "Dots"

china, white, underside biscuit, surface glazed, nubby on one half for the safe placement of miniatures

item	l x w x h in cm	PU
4506	30x18.5x2.2	3 pcs

small bowl

china, white, rectangular

item	l x w x h in cm	content in l	PU
3858	13.5x6.5x2	0.07	12 pcs

small bowl

china, white, square

item	l x w x h in cm	content in l	PU
3859	6.5x6.5x2	0.03	12 pcs

small glass bowl

clear glass, square, delivery without lid item 5338.01 (please order separately)

item	l x w x h in cm	content in l	PU
5338	7x7x3.9	0.1	12 pcs

glass miniature

clear glass, square, lid for small glass bowl item 5338

item	l x w in cm	PU
5338.01	7x7	12 pcs

small glass bowl

clear glass, square, delivery without lid item 5254.01 (please order separately)

item	l x w x h in cm	content in l	PU
5254	4.9x4.9x4.5	0.05	4 pcs

Aside from being decorative elements, the nubs on the surface of the "Dots" plate are a simple and functional means to place miniatures made of glass and porcelain safely. The separation of liquid and solid, hot and cold food can be realized in an easy and visually appealing way.

No matter if it is used for sushi, desserts or Fine Dining, "Dots" is ideal for lots of applications!



glass miniature

clear glass, lid for small glass bowl item 5254 and glass creamer item 5255

item	l x w in cm	PU
5254.01	4.9x4.9	12 pcs

small glass creamer

clear glass, square, delivery without lid item 5254.01 (please order separately)

item	l x w x h in cm	content in l	PU
5255	4.9x4.9x4.5	0.05	4 pcs

"Velo"



plate "Velo"

china, black, mett, surface glazed, underside biscuit

item	l x w x h in cm	PU
4505.01	27x20x2.8	3 pcs



plate "Velo"

china, white, surface glazed, underside biscuit

item	l x w x h in cm	PU
4505	27x20x2.8	3 pcs



Design: Itamar Harari





glass tray

glass, deep black, rectangular, for buffet or flying buffet or functions as a tray

item	l x w x h in cm
5141.26	26x14x2
5141.34	34x18x2
5141.50	51x35x2



glass tray

glass, deep black, square, for buffet or flying buffet, functions as a tray or as a dinner plate

item	l x w x h in cm
5142.34	35x35x2



glass tray

glass, deep black, with 3 oval sockets (diagonal, 4.7 cm x 8.5 cm at bottom area), for bowl items 4081.12 (china) and 5444 (glass)

item	l x w in cm
5143	32x14



glass tray

glass, deep black, with 3 round sockets (Ø 6 cm at bottom area)

item	l x w in cm
5145	32x12



glass tray with bowls

set consists of:

glass tray, deep black
3 china bowls "Duo", white, 0.08 l content each
 1 set in black gift box

item	l x w in cm	PU
5135.PB	32x12	1 set (4 parts) 📦



"SelectionA." gives creative chefs the opportunity to present their food in many different ways in order to leave a mark on their guests both by taste and looks. The dish moves closer to the guest and single parts almost seem to be floating freely in the room. The diversity of variations of this series, when combined with other items, is nearly unlimited.



The series consists of different plates and bowls made of porcelain. So-called charger plates are available in two versions which can be used on their own or in combination with various attachments. These form the basis of the system. Shapely rings made of silicone available in two sizes, in black or white, allow for a piling of different accessories and are completely slip-proof. Surfaces are matt structured and form an interesting contrast to the porcelain's shiny gloss. These pieces can be consciously used as design elements or, as well, be assembled almost invisibly. There are no limits to the chef's imagination.

A third ring outside the series (page 224) has been designed to hold test-tubes, the ribbed surface structure ensuring easy insertion of the tubes.



1 charger plate "SelectionA."
china, white, with plateau (Ø 9.5 cm)

item	Ø in cm	PU
4491	28	3 pcs



2 charger plate "SelectionA."
china, white, with hollow (Ø 11 cm, 0.15 l content)

item	Ø in cm	PU
4492	28	3 pcs



3 plate "SelectionA."
china, white, with hollow (4493.19: Ø 6.2 cm, 0.05 l content, 4493.24: Ø 9 cm, 0.14 l content)

item	Ø in cm	PU
a)4493.19	19	6 pcs
b)4493.24	24	6 pcs



4 plate "SelectionA."
china, white, oval

item	l x w in cm	PU
4495	25x12	6 pcs



5 ring "SelectionA."
silicone, for inlaying/stacking of the china series "SelectionA.", Ø 8.3 cm

item	colour	PU
a)4681.S	black	6 pcs
b)4681.W	white	6 pcs



6 ring "SelectionA."
silicone, for inlaying/stacking of the china series "SelectionA.", Ø 13.4 cm

item	colour	PU
a)4682.S	black	3 pcs
b)4682.W	white	3 pcs



2+5b+4

7 small glass bowl/cloche
clear glass, handblown, for ring "SelectionA." items 4681... (please order separately)

item	Ø / height in cm	content in l	PU
5418	9 / 6	0.2	6 pcs



8 glass bowl
dark grey, round, handblown, ground edge, for ring "SelectionA." items 4681...

item	Ø in cm	height in cm	content in l
4814.17	17	5.5	approx. 0.3



9 small glass bowl
glass, 2 layers, handmade, heavy quality, Ø 7 cm, 4.5 cm high, approx. 0.08 l content

item	colour	PU
a)4859.07	white	6 pcs
b)4860.07	black	6 pcs



10 bowl
massive stainless steel 18/10, triangular, hammered finish, six times polished

item	Ø in cm	height in cm	content in l
a)2180.09	9	4	0.08
b)2180.13	13	6	0.28

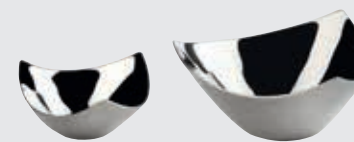

11 bowl
massive stainless steel 18/10, triangular, smooth finish, six times polished

item	Ø in cm	height in cm	content in l
2182.09	9	4	0.08
2182.13	13	6	0.28



1+3b



2+3a+5b



2+5a+9b



3b+5a+10a

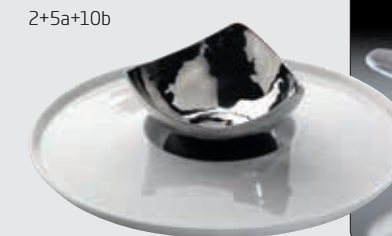

2+5a+10b



1

cake of carrots

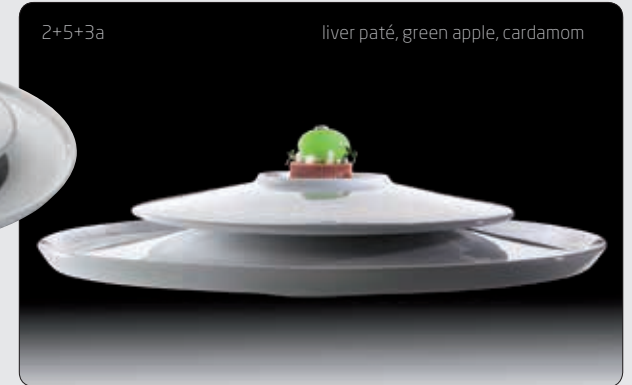

2+5+3a

liver paté, green apple, cardamom



2

poulard, purple curry, maize

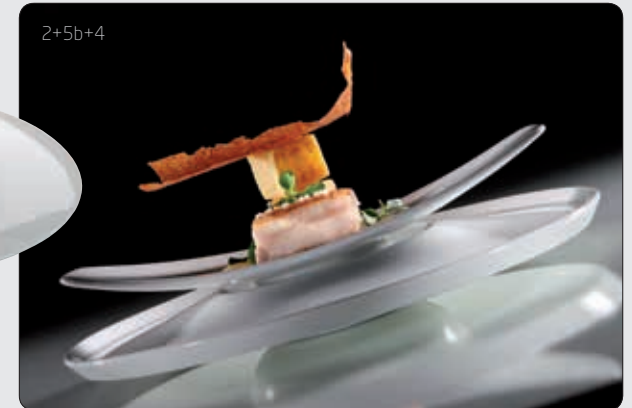

2+5b+4



4

"Flow"



"Flow" permits a variety of new creative potential to the chef, a possibility to present different elements in a new and perfect way. Since it comes in two sizes, the tubes can be applied in any part of the kitchen: The small "Sauce Flow" is especially suited for presenting sauces during the main course or entrée. The "Soup Flow" is extraordinarily interesting when serving soup in transparent glass either standing or flowing with some puree acting as sealing. It is possible to present liquids in layers which can be released either by service staff or the guests themselves. That way liquid food can be set up in a very stylish way, separated from any crispy food. With salad designed as biosphere or a vegetable skyscraper - there is no limit to your imagination except the edge of the plate.

The glass tubes "Flow" are available in two sizes and made of high-quality borosilicate glass which stands out due to its hardness and high temperature resistance.

4989 + 4492 (page 158)



glass tube "Sauce Flow"

borosilicate glass, open at the top and at the bottom

item	Ø / height in cm	content in l	PU
4990.02	5 / 5.5	0.1	6 pcs



glass tube "Soup Flow"

borosilicate glass, open at the top and at the bottom

item	Ø / height in cm	content in l	PU
4989	6.5 / 11	0.4	6 pcs



napkin ring "Reef"

pewter, surface smooth, food-safe, not dishwasher-safe

item	Ø in cm	length in cm	PU
2317	5.5x3.5	7.5	2 pcs

napkin ring "Reef"

in black gift box

item	Ø in cm	length in cm	PU
2317PB	5.5x3.5	7.5	2 pcs

The glass tube "Flow" item 4990.02 can also be used as a napkin ring.



The "Modul" bridge made of walnut und suitable inserts are available on pages 132 and 138.

"Modul"



plate "Modul"

china, white, square, flat, item 4385.22 fits base trays "Modul" made of walnut and melamine

item	l x w in cm	PU
4385.22	22x22	6 pcs
4385.27	27x27	4 pcs

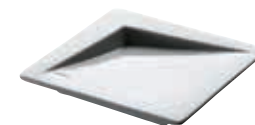

plate "Modul"

china, white, square, flat, for base trays "Modul" made of walnut and melamine

item	l x w in cm	PU
4380	11x11	12 pcs



plate "Modul"

china, white, flat, rectangular, for base trays "Modul" made of walnut and melamine

item	l x w in cm	PU
4383	22x11	12 pcs



More party spoons made of china and stainless steel are available on page 233.



amuse-gueule/tapas spoon "Modul"

china, white

item	l x w x h in cm	PU
4260.03	10x4x2.2	12 pcs



bowl "Modul"

china, white, square, deep, for base trays "Modul" made of walnut and melamine

item	l x w in cm	content in l	PU
4381	11x11	0,07	12 pcs

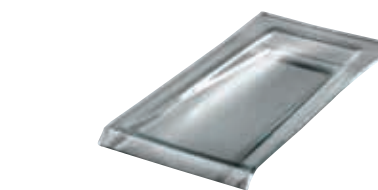

glass plate "Modul"

glass, transparent, structured, flat, rectangular, for base trays "Modul" made of walnut and melamine

item	l x w in cm	PU
5074.01	22.5x11	6 pcs



bowl "Modul"

china, white, deep, rectangular, for base trays "Modul" made of walnut and melamine

item	l x w in cm	content in l	PU
4384	22x11	0,22	12 pcs

"oro79"

"Catering de Luxe"



plate "oro79"
china, golden surface, dishwasher-safe, not suitable for microwave and combi steam oven, with foot

item	l x w x h in cm	PU
4564.12	12x12x1.5	2 pcs
4564.19	19x19x1.5	2 pcs
4564.26	26.5x26.5x1.5	1 pc.



"oro79" is pure luxury!
This exclusive miniseries captivates by its extraordinary surface with its golden mother-of-pearl look. A quartered ball allows serving a variety of food in an entirely new way.

"oro79" offers exceptional service for the most demanding guests!

Non-slip coasters are available on page 210, the glass series "Amuse" is available on pages 212 to 216.



plate "oro79"
china, golden surface, dishwasher-safe, not suitable for microwave and combi steam oven, with foot

item	l x w x h in cm
4565.35	35x14x1.5



china ball "oro79"
china, outside golden, dishwasher-proof, not suitable for microwave and combi steam oven, 4 parts (3 bowls: 0.5 l / 0.6 l / 0.25 l content + lid)

item	Ø in cm	height in cm
4563	15.5	15.8



"Catering"

- High-quality white china
- In accordance with international standards
- Cups with glazed rims
- Stackable
- Dishwasher-safe



flat coup plate

item	Ø in cm	PU
3954.08	8	12 pcs
3954.15	15	12 pcs
3954.19	19	12 pcs
3954.21	21	12 pcs
3954.25	25	12 pcs
3954.28	27.5	12 pcs



flat plate

item	Ø in cm	PU
3955.16	16	12 pcs
3955.20	20	12 pcs
3955.26	26	12 pcs
3955.30	29.5	6 pcs



flat plate

black, matt, round, with round deepening (Ø 9.3 cm)

item	Ø in cm	height in cm	PU
3857	13.5	1.5	6 pcs



deep plate

item	Ø in cm	PU
3956.23	23	12 pcs
3971.30	30	6 pcs



oval coup platter

item	l x w x h in cm	PU
3939.30	30x17.5x3.5	6 pcs



salad bowl

item	Ø in cm	height in cm	PU
3963.14	14	4.5	12 pcs
3963.16	16	4.5	12 pcs
3963.19	19	6	12 pcs
3963.23	23	6.5	6 pcs



coffee cup

item	version	PU
3958.0	cup / 0.18 l	12 pcs
3958.U	saucer / Ø 15 cm	12 pcs



soup bowl

item	version	PU
3960.0	bowl / 0.4 L	12 pcs
3960.U	saucer / Ø 17 cm	12 pcs



small bowl

item	Ø / height in cm	content in l	PU
3962.06	6 / 3	0.03	24 pcs



egg cup

item	Ø in cm	height in cm
3977	5	5



creamer

item	Ø / height in cm	content in l	PU
4489	5.3 / 9	0.13	6 pcs



miniature

Ø 5.3 cm, 7 cm high, 0.1 l content

item	colour	PU
4490	white	6 pcs
4490.01	black	6 pcs



small bowl

item	Ø / height in cm	content in l	PU
4499	8 / 5.5	0.2	6 pcs
4500	8 / 2.5	0.08	12 pcs



plate "Catering de Luxe"

china, white, deep

item	Ø in cm	PU
4280.22	22	6 pcs
4280.30	30	3 pcs



bowl "Catering de Luxe"

china, white, bowl item 4281 to insert in deep plate "Catering de Luxe" item 4280.22 and bowl item 4281.02 to insert in deep plate "Catering de Luxe" item 4280.30

item	Ø / height in cm	content in l	PU
4281.01	12 / 5/6.5	0.25	12 pcs
4281	14 / 5.5/7.5	0.35	6 pcs
4281.02	19 / 7.5/10	1.0	6 pcs
4281.03	24 / 9.5/12.5	2.0	2 pcs
4281.04	28 / 11/14.5	3.5	2 pcs

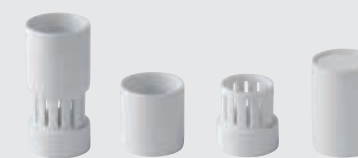

fondue set, 2 parts

china, white, for tea lights
upper part: Ø 6.3 cm, 7 cm high, 0.14 l content
lower part: Ø 6.3 cm, 7 cm high

item	total height in cm	PU
4359	13.5	6 pcs



small skewer "Flame"

stainless steel 18/0, matt

item	length in cm	PU
1939.04	9.5	24 pcs

"Catering de Luxe"



“Cave”

Like the shell hides the pearl, the porcelain bowl “Cave” conceals precious delicacies within its hard shell. At first sight this porcelain piece only partly reveals its interior. “Cave” consists of intricately worked hard porcelain and captures by its soft shape and the velvety haptics of the unglazed outside. Touching the cave-shaped bowl it feels almost like a palm stone made of white gold, having a soft appearance with delicious contents.

“Cave” is predestined for a use at cocktail and hors d’oeuvres receptions or at the flying buffet. The miniature bowl can be carried comfortably and perfectly fits in the palm of the hand.



bowl “Cave”

biscuit china, white, inside glazed, opening: Ø approx. 8 cm, in black gift box

item	Ø in cm	height in cm	PU
4375.01PB	approx. 11	7	1 pc.



Design: Wilma Greim

Stay cool!

Serving chilled food is primarily a technical challenge with certain dishes or intermediate courses. With Zieher’s two-coloured cooling pads, this necessity can be met in a sophisticated way, also in terms of visual appearance. The wrapper made of black respectively white nylon fabric appears classy and unobtrusive. The pads are filled with gel which remains shapeable even when frozen and thus allows an adjustment to the tableware used.

The cooling pads are also applicable on the buffet. More information is available on page 42 and 43.



cooling pack
nylon, black/white, non-toxic cooling gel

item	l x w in cm
5663.20	20x20

The glass version of the “Cave” bowl is available in two sizes. The soft tinge of this grey glass, which is manufactured in a traditional hand-blowing process, stages the content of these shapely objects.

“Cave”

They offer the fitting framework for fruit, nuts and nibbles as well as for tastefully arranged pasta or salad on a solemnly decorated table. The content of the bowls remains protected by the shell of glass, the amply dimensioned opening seduces to snap at a chance. These unique items enthrall as well as a place to keep all kinds of accessories.



glass bowl “Cave”

dark grey, round, handblown, ground edge

item	Ø in cm	opening Ø in cm	height in cm
4815.18	approx. 18	approx. 14	approx. 11.5
4815.24	approx. 24	approx. 19	approx. 16.5

glass bowl “Cave”

in black gift box

item	Ø in cm	opening Ø in cm	height in cm
4815.18PB	approx. 18	approx. 14	approx. 11.5
4815.24PB	approx. 24	approx. 19	approx. 16.5



glass bowl

dark grey, round, handblown, ground edge

item	Ø in cm	height in cm	content in l
4814.17	17	5.5	approx. 0.3
4814.23	23	9.5	approx. 1.5
4814.30	30	13	approx. 3.25
4814.40	40	10	approx. 4.5



Please note: We recommend the use of the silicone rings 4681... for the smallest bowl.



ring “SelectionA.”

silicone, Ø 8.3 cm, for glass bowl item 4814.17

item	colour	PU
4681.S	black	6 pcs
4681.W	white	6 pcs



ring “SelectionA.”

silicone, Ø 13.4 cm, for glass bowl items 4814.23 and 4814.30

item	colour	PU
4682.S	black	3 pcs
4682.W	white	3 pcs



"Capiz"



bowl "Capiz"
shell, ivory-coloured, oval, resin-coated, not dishwasher-safe

item	l x w x h in cm
7106.46	46.5x24x13.5



tray "Capiz"
shell, ivory-coloured, square, resin-coated, not dishwasher-safe

item	l x w x h in cm
7103.20	20x20x2
7103.26	26x26x2



charger plate "Capiz"
shell, ivory-coloured, organically shaped, resin-coated, not dishwasher-safe

item	Ø in cm	PU
7100.36	36	2 pcs



charger plate "Capiz"
shell, ivory-coloured, resin-coated, not dishwasher-safe

item	Ø in cm	PU
7115.36	36	2 pcs



In combination with ice and the Zieher rechargeable LED-lights the double-walled bowls produced in mosaic-look create fascinating effects, thus becoming the eye-catcher at the buffet (page 65).



Ivory-coloured, nacreous gloss grants these products their special appeal. Genuine clamshells are grinded razor-thin and embedded in robust resin. This process protects and stabilizes the delicate clamshell-wafers in the long term. The transparent resin creates an impressive depth effect and classy shine on every item of the "Capiz" series. This especially applies to the structured surfaces and shoulders of the dinner plates.

"Ice"



dinner plate "Ice"
glass (crimped glass chips), white, round, bevelled edges, dishwasher-safe

item	Ø in cm	height in cm
5760.35	35	2



dinner plate "Ice"
glass (crimped glass chips), white, square, bevelled edges, dishwasher-safe

item	l x w x h in cm
5761.33	33x33x2



glass platter "Ice"
glass (crimped glass chips), white, rectangular, bevelled edges, dishwasher-safe

item	l x w x h in cm
5762.16	16x12x2
5762.33	33x12x2
5762.40	40x15x2

Please note:
due to the material properties, minor imperfections and air inclusions may occur around the edges.



The absolutely stunning plates of the "Ice" series are made of glass chips which are coalesced and compressed. This procedure allows white and transparent materials to form a most charming pattern. The horizontal look of ice floes paired with the layered structure at the edges brings to mind an ice plate freshly cut from a frozen, wintery lake.



Bevelled edges provide an elegant look as well as easy handling. No matter if it is used as a dinner plate or as a sushi plate, for the presentation of a variety of cheese or the staging of desserts, muted colours combined with a clear structure create a perfect basis for stylishly putting artful creations in the limelight.



The cloche item 4880.30 is available on page 179.

Sushi

The napkin ring of the "Reef" series is available on page 64.



More platters made of special hardened safety glass are available on pages 48 to 52.



glass platter

special hardened safety glass, 4 mm thick, rectangular, rounded edges, polished rim, dishwasher-safe, rubber feet included (adhesive), underside scratch-proof

item	version	l x w in cm
1668.10	black glass	30x18
1670.10	white glass	30x18



small glass bowl

glass, 2 layers, handmade, heavy quality, Ø 7 cm, 4.5 cm high, approx. 0.08 l content, for sushi platter item 8035

item	colour	PU
4859.07	white	6 pcs
4860.07	black	6 pcs



chopsticks

borosilicate glass, satined, handmade, please note the safety instructions on each pack (not suitable for children)

item	length in cm	PU
4885	21.5	1 set (2 parts)



chopstick/knife rest "Flex"

borosilicate glass, transparent, handmade

item	l x w in cm	height in cm	PU
4886	8x2.3	approx. 2	2 pcs



chopsticks with knife rest

set consists of:

chopsticks, borosilicate glass, satined, handmade
knife rest, borosilicate glass, transparent, handmade
 2 sets in black gift box

item	l x w in cm	height in cm	PU
4887.PB	21.5 / 8x2.3	approx. 2 (rest)	2 sets (6 parts)



sushi set

set consists of:

glass platter, dark grey with spiral structure
china bowl "Cuspis" incl. black silicone coaster
chop sticks "Goa" incl. bench,
 1 set in black gift box

item	l x w in cm	PU
5170.PB	approx. 38x15.5	1 set (6 parts)

The platter "Dots" is available on page 154.



Sushi



The "Cuspis" series is available on page 205, more sizes of the platters with spiral structure on page 173.



sushi plate

granite, anthracite, completely polished, with hole (Ø 5.7 cm) for different inserts of glass, china, ...

item	l x w x h in cm
8035	40x15x2.5



sushi plate

granite, anthracite, completely polished, feet of felt

item	l x w x h in cm
8028	25x25x3



bowl

granite, anthracite, fully polished

item	Ø in cm	height in cm
8034	18	7



The black grey glass platter is available on page 172.



The glass platters of the "Ice" series are available on page 169.





buffet bowl
glass, 8 mm thick, dark grey, oblong, structured

item	l x w x h in cm
5703	96x29x10



glass plate
glass, 4 mm thick, dark grey, round, with spiral structure

item	Ø in cm	height in cm	PU
5177.20	20	2.5/4.5	6 pcs
5177.25	25	3/6	6 pcs
5177.28	28	3.5/7	4 pcs



glass plate
glass, 8 mm thick, dark grey, rectangular, with the structure of tree bark

item	l x w in cm	PU
5702	40x22	2 pcs

spoon rest/glass miniature
glass, 4 mm thick, dark grey, with spiral structure

item	l x w in cm	PU
5168.06	approx. 6.5x5	12 pcs



The glass miniature is available on page 229.

glass plate
glass, 8 mm thick, dark grey, oval, with the structure of tree bark

item	l x w in cm	PU
5700	33x24	3 pcs



glass bowl
glass, 8 mm thick, dark grey, oval, with the structure of tree bark

item	l x w x h in cm	PU
5701	26.5x19.5x4.5	3 pcs



glass platter/plate
glass, 6 mm thick, dark grey, with spiral structure

item	l x w in cm	PU
5168.14	approx. 14x10.5	6 pcs
5168.25	approx. 25x20.5	6 pcs
5168.30	approx. 30.5x25	4 pcs



glass platter/plate
glass, 6 mm thick, dark grey, oblong, with spiral structure

item	l x w in cm	PU
5169.31	approx. 31x12.5	6 pcs
5169.38	approx. 38x15.5	4 pcs
5169.41	approx. 41.5x12.5	4 pcs



glass bowl
glass, 4 mm thick, dark grey, square, structured

item	l x w x h in cm	PU
5016.24	24x24x5	2 pcs



sushi set
set consists of:
glass platter, dark grey with spiral structure
china bowl "Cuspis" incl. black silicone coaster
chop sticks "Goa" incl. bench
1 set in black gift box

item	l x w in cm	PU
5170.PB	approx. 38x15.5	1 set (6 parts)





The miniature bowls made of glass or china are available on page 271.



glass platter

glass, structured, transparent, rectangular, four divisions

item	l x w in cm
5084	33x12



glass platter

glass, structured, transparent, rectangular

item	l x w in cm
5062	30x23

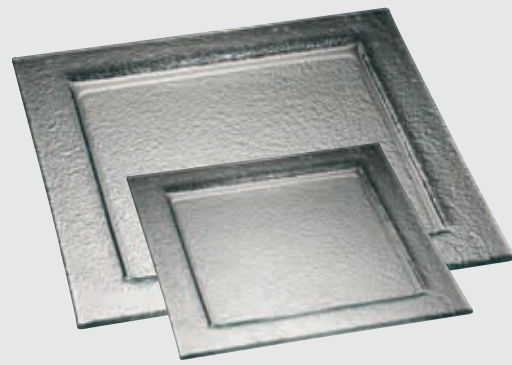

glass platter

glass, structured, transparent, square

item	l x w in cm
5063	30x30
5063.50	50x50



glass plate "Vario"

glass, structured, satined, square, with 9 sockets

item	l x w in cm
5088	30x30

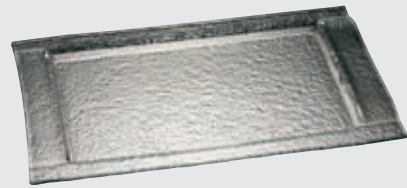

buffet platter

glass, structured, transparent, rectangular, with handles

item	l x w in cm
5075.40	40x25

The miniature bowl item 4082 made of china is available on page 230.



glass platter

glass, structured, transparent, rectangular

item	l x w in cm
5064	33x12



glass platter, 1/1 GN

glass, structured, transparent, undulated edge

item	l x w in cm
5020	53x32.5



The glass trays are available on page 57.



glass bowl

clear glass, oval

item	Ø / height in cm	content in l	PU
5330.08	7.5 / 3.5	0.08	6 pcs
5330.20	20 / 10	1.1	1 pc.
5330.24	24 / 12	2.3	1 pc.
5330.29	29 / 14.5	3.3	1 pc.



The wine cooler of the "Skyline" series is available on page 18.



glass carafe

clear glass

item	Ø in cm	height in cm	content in l
5352	9	31	1.0



glass bowl

clear glass, square

item	l x w x h in cm
5346	35x35x8



caviar set

clear glass, square, big bowl: 14 cm x 14 cm x 8.5 cm, 0.67 l content, small bowl: 8 cm x 8 cm x 4.5 cm, 0.1 l content

item	l x w x h in cm	PU
5347	14x14x10	1 set (3 parts)



glass platter

clear glass, oval

item	l x w x h in cm	PU
5331.30	30x9.5x2	2 pcs



illustrated combination:
3x item 5330.08 on item 5331.30



5329.25 + 2141.01 (page 82)

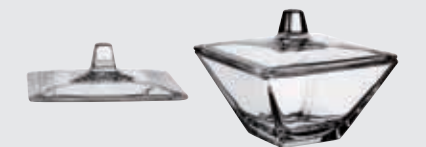

glass lid

clear glass, for glass bowl item 5308.11

item	l x w in cm	PU
5308.11D	11x11	24 pcs

glass bowl

clear glass, round

item	Ø / height in cm	content in l	PU
5329.14	14 / 8.5	0.6	6 pcs
5329.21	21.5 / 12.5	2.3	1 pc.
5329.25	25 / 15	3.5	1 pc.



The buffet stands "Skyline" are available on pages 14 to 18.



The bread/pastry bowl is available on page 85.



glass bowl

clear glass, square

item	l x w x h in cm	content in l	PU
5308.08	8x8x4.5	0.14	6 pcs
5308.11	11x11x6	0.3	6 pcs
5308	14x14x8	0.7	6 pcs
5308.20	20x20x11	1.8	1 pc.
5308.26	26x26x12.5	3.5	1 pc.

Making precious materials more precious - whether it is glass or china ...



"gold"



"platinum"

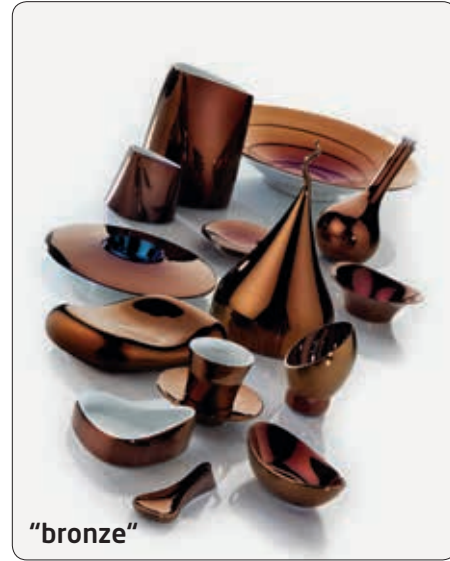

"bronze"

... everything is possible!

Large-scale coatings on glass and china in precious colours enrich every dining table and create luxurious accents!

In order to achieve this decorative style, available in gold, platinum and bronze, the precious metals are burnt onto the varnish at more than 880 °C and as a result the coating is dishwasher-safe. Cloches made of glass can now be used for serving warm dishes as well and condensing water remains invisible to a great part.

By using resistant precious alloys we obtain a connection to the varnish which is strong enough for the products to become dishwasher-safe. Test series by the "Institut für Werkstoffe Heraeus Precious Metals GmbH & Co. KG" have proven the dishwasher resistance of the décor.

Partially, the possibilities of coating are dependent on the form of the product. Requests are being tested in each case according to their feasibility.

The bronze colour is a special case since it presents itself in numerous interesting shades of colour. Depending on the shape of the product, especially when looking at immersions, the colours can vary from gold-bronze shades to blue-violet ones which blend into each other and create unique effects.

Since the products are refined in Germany, specific patterns/orders are usually executed quickly. Please do not hesitate to send us your special request!



Satin-coated logos applied before the refinement still remain visible.

colour gradient "bronze"

The complete information on refining stainless steel is available on page 76.

Please note:

Products are dishwasher-resistant. Please take note of the instructions given by dishwasher producers and detergents to avoid damage.

Since the coatings are made of precious metals, the use in microwaves is not recommended under any circumstances.



Cloches



of some other kind!

"Cuspis"

The cloches and porcelain coasters of the series "Cuspis" are inspired by the nuts of the oak tree. The ball-shaped handle at the tip of the cloches allows for an uncomplicated handling of these classy covers. The unglazed outside of the porcelain coasters with its distinctive texture is reminiscent of acorn caps. The coaster can be used on both sides. When used as a plateau plate, the dishes move closer to the guest, while the filigree glass cloche protects the presented delicacies and puts them in the limelight. Used as a bowl, it offers space for gravies, sauces and more.



glass cloche "Cuspis"
borosilicate glass, transparent, handblown, star-shaped ball handle

item	for plate/bowl	Ø in cm	height in cm
4940.08	4389.09	8.5	12.5
4940.10	4389.11	10.5	14.5
4940.25	4389.25PB	25	32.5



plateau plate/small bowl "Cuspis"
china, white, inside and useable area (plateau Ø approx. 6 cm/8 cm) glazed, outside biscuit, also useable as a bowl

item	Ø in cm	height in cm	content in l
4389.09	9	3	0.1
4389.11	11.5	3.5	0.18



plateau plate/bowl "Cuspis"
china, white, inside and useable area glazed, outside biscuit, useable on both sides, for cloches items 4940.25 and 4940.10 (bottom side), in black gift box

item	Ø in cm	height in cm	content in l
4389.25PB	25	2.8	0.8



**cloche with plateau plate/
small bowl "Cuspis"**
set consists of:
cloche made of borosilicate glass, transparent, handblown, with star-shaped ball handle
plateau plate made of white china, inside and useable area glazed, outside biscuit, useable on both sides, 1 set in black gift box

item	Ø in cm	height in cm	PU
4943.08PB	9	approx. 14/14.5	1 set (2 parts)
4943.10PB	11.5	approx. 17/17.5	1 set (2 parts)
4943.25PB	25	approx. 33/35	1 set (2 parts)

If the item is used upside down as a plate, the two rings on the plate's underside can be used to separate the prepared dish into different sections and the cloches of the "Cuspis" series may also be used with it (4940.10 on the inner ring, 4940.25 on the outer ring).

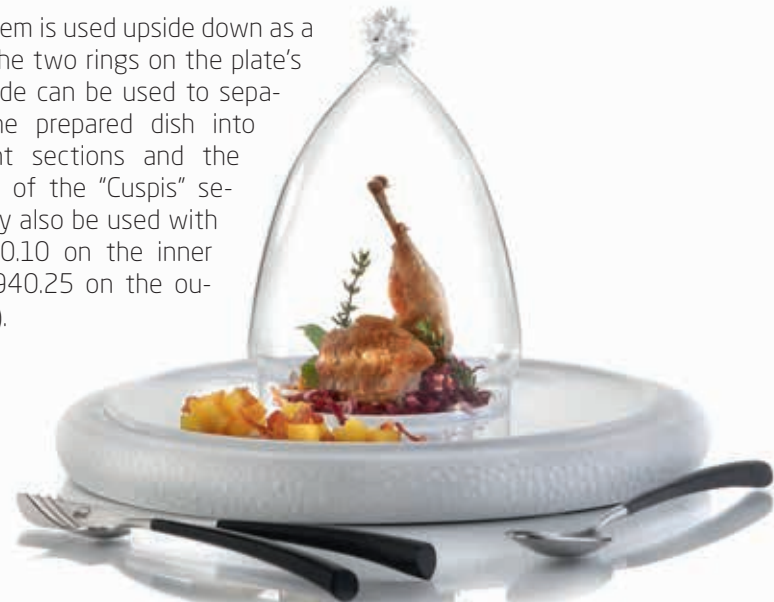

glass cloche
borosilicate glass, transparent, handblown, handmade, for coaster "Solid" items 4734...

item	Ø in cm	height in cm
4880.18	18.5	approx. 29-32
4880.22	22.5	approx. 35-38
4880.26	26	approx. 41-44
4880.30	30	approx. 48-51



coaster/glass insert
hardened clear glass, 4 mm thick, round, edge polished and deburred, with 4 transparent silicone feet

item	Ø in cm	for coaster "Solid" item
5244.17	16.7	4734.01
5244.21	20.7	4734.02
5244.24	24.2	4734.03
5244.28	28.2	4734.04



coaster "Solid"
walnut, food-safe sealed, not dishwasher-safe, stackable, for glass cloche items 4850, 4851, 4852 and 4880... and glass inserts items 5244...

item	Ø / height in cm	for cloche / insert
4734.01	23 / 3	Ø 18.5 / 16.7 cm
4734.02	27 / 3	Ø 22.5 / 20.7 cm
4734.03	30.5 / 3	Ø 26 / 24.2 cm
4734.04	34.5 / 3	Ø 30 / 28.2 cm



**cloche with wooden coaster
and glass insert**
set consists of:
cloche made of borosilicate glass
insert made of hardened transparent glass (4 mm thick)
saucer made of walnut, 1 set in black gift box

item	Ø in cm	height in cm	PU
4882.22PB	27	approx. 37-40	1 set (3 parts)
4882.30PB	34.5	approx. 50-53	1 set (3 parts)

The glass cloches, which are available in 10 sizes (diameters 5 cm to 30 cm, pages 179 to 182), delight by their high quality and unusual form! The presentation of fine truffles, an exclusive choice of cheese or simply a single praline – there is a fitting size for each purpose!

The lightweight cloches by Zieher are heat resistant, dishwasher safe and very easy to handle for the guests. Each item is manufactured by hand and therefore shaped individually.

The raw material for these items is borosilicate glass, which is mainly used for laboratory dishes. Its main features are a great resistance against heat and changes in temperature as well as a high break resistance. A wine cooler of the same design is available on page 56.



The cheese presentation system "Solid" is available on pages 102 and 103.





More sizes and variations of the cloches made of glass are available on the following pages.

Ø 5 cm



glass cloche

borosilicate glass, transparent, handblown, handmade

item	Ø in cm	height in cm	PU
4982.05	5	approx. 8-9	6 pcs

Ø 6 cm



glass cloche

borosilicate glass, transparent, handblown, handmade

item	Ø in cm	height in cm	PU
4982.06	6	approx. 9.5-10.5	6 pcs

Ø 7 cm



glass cloche

borosilicate glass, transparent, handblown, handmade

item	Ø in cm	height in cm	PU
4982.07	7	approx. 11-12	6 pcs



small bowl

china, white, deep, oval

item	l x w x h in cm	content in l	PU
4326.11	11x9x3.8	0.1	12 pcs



glass tray

glass, deep black, with 3 round sockets (bottom area: Ø 6 cm)

item	l x w in cm
5145	32x12

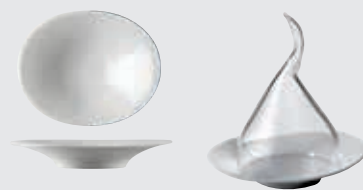

miniature plate

china, white, flat, oval

item	l x w x h in cm	PU
4324.11	11x9x1.8	12 pcs



glass miniature plate

glass, deep black, flat

item	l x w in cm	PU
5034.01	10x10	12 pcs

Ø 9 cm



glass cloche

borosilicate glass, transparent, handblown, handmade

item	Ø in cm	height in cm
4982.09	9	approx. 14-16



wind light

borosilicate glass, with 3 notches at the bottom, open at the top, handmade, Ø 9 cm, approx. 12 - 13 cm high

item	version
4987.01	transparent
4987.02	satined (inside)



glass cloche/small bowl "Amuse"

borosilicate glass, transparent, handblown, single-walled

item	Ø / height in cm	content in l	PU
4916	9 / 6	approx. 0.2	6 pcs



coaster/glass insert

hardened clear glass, 4 mm thick, round, edge polished and deburred, with 4 transparent silicone feet, for coaster "Solid" item 4700.01

item	Ø in cm	PU
5244.09	9	6 pcs



coaster "Solid"

walnut, food-safe sealed, not dishwasher-safe, for glass insert item 5244.09

item	Ø / height in cm	Ø inner circle in cm
4700.01	15.3 / 2	9.3



plate

china, black, matt, flat, round, dishwasher-safe, for cloches with Ø 9 cm

item	Ø in cm	height in cm	PU
3857	13.5	1.5	6 pcs





Ø 11 cm



glass cloche

borosilicate glass, transparent, handblown, handmade

item	Ø in cm	height in cm
4982.11	11	approx. 17-19



wind light

biscuit china, white, translucent, with a round, oblique opening, for coaster item 4398

item	Ø in cm	height in cm	PU
4397	11	13.5	6 pcs

coaster

biscuit china, white, inner circle glazed (Ø 9.5 cm), for round items with an inner diameter of 10.5 cm

item	Ø in cm	height in cm	PU
4398	11.5	1.3	6 pcs

plate "SelectionA."

china, white, with hollow (Ø 9 cm, 0.14 l content), for cloches with Ø 11 cm

item	Ø in cm	PU
4493.24	24	6 pcs

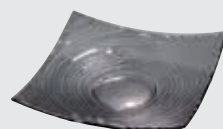

glass bowl

glass, 4 mm thick, dark grey, square, structured, for cloches with Ø 11 cm

item	l x w x h in cm	PU
5016.24	24x24x5	2 pcs

Ø 13 cm



glass cloche

borosilicate glass, transparent, handblown, handmade

item	Ø in cm	height in cm
4982	13	approx. 20-23



glass cloche/small bowl "Amuse"

borosilicate glass, transparent, handblown, single-walled

item	Ø / height in cm	content in l	PU
4917	13 / 7.5	approx. 0.5	4 pcs



coaster/glass insert

hardened clear glass, 4 mm thick, round, edge polished and deburred, with 4 transparent silicone feet, for coaster "Solid" item 4700

item	Ø in cm	PU
5244	13	6 pcs



coaster "Solid"

walnut, food-safe sealed, not dishwasher-safe, for glass insert item 5244

item	Ø / height in cm	Ø inner circle in cm
4700	22 / 2	13.3



tray

massive stainless steel 18/10, smooth finish, six times polished, round, with raised edge, for cloches with Ø 11 cm and 13 cm

item	Ø in cm	height in cm
2188.14	14	1.5



The plates made of stoneware are available on page 261.



glass cloche

crystalline glass, transparent, handblown, for a utility space of Ø 9.5 cm or Ø 14.5 cm respectively

item	Ø in cm	height in cm	PU
5482.10	10.5	1.3	2 pcs
5482.15	15.5	19.5	1 pc

glass cloche

in black gift box

item	Ø in cm	height in cm	PU
5482.10PB	10.5	1.3	1 pc



The glass NOSTALGIC of the VISION series is available on page 199.

Cloches

The glasses of the series VISION are available on pages 198 and 199, the gourmet plate "Pulsar" on page 140.



The series "Capiz" is available on page 168, charger plates in different variations on the following pages



Little somethings perfectly staged!

The thick bottom of the hand-blown bowl leads to a blow-up effect when used as a cloche!



small glass bowl/cloche

clear glass, handblown, for ring "SelectionA." items 4681... (please order separately)

item	Ø / height in cm	content in l	PU
5418	9 / 6	0,2	6 pcs



ring "SelectionA."

silicone, Ø 8,3 cm, for the anti-slip placement of small glass bowl/cloche item 5418

item	colour	PU
4681.S	black	6 pcs
4681.W	white	6 pcs



plate

china, black, matt, flat, round, dishwasher-safe, for cloches with Ø 9 cm

item	Ø in cm	height in cm	PU
3857	13,5	1,5	6 pcs



glass cloche

clear glass, handblown, with handle, for glass stands items 4854... (please order separately)

item	Ø in cm	height in cm
4853	10,5	11,5



glass stand

clear glass, handblown, with round foot (Ø 8 cm) and platform (Ø 11,5 cm), for glass cloche item 4853

item	height in cm
4854.01	13
4854.02	16,5
4854.03	23



glass cloche

clear glass, handblown, with round handle, for saucer "Solid" items 4734...

item	Ø in cm	height in cm
4850	18,5	31
4851	22,5	37
4852	26	43



charger plate

special hardened safety glass, 4 mm thick, edge polished, dishwasher-safe, rubber feet included (adhesive), under-side scratch-proof

item	version	Ø in cm
1669.33	black glass	33
1671.33	white glass	33



glass cloche

clear glass, for pastry/cake stand items 5349...

item	Ø in cm	height in cm
5350.16	16	13
5350.23	23	16,5
5350.27	27,5	20,5



pastry/cake stand

clear glass, with foot

item	Ø in cm	Ø foot in cm	height in cm
5349.21	21	10,5	9,5
5349.28	28	13	11,5
5349.33	33,5	13	11

The saucer "Solid" items 4734... are available on page 179.



Each cloche is handblown and handcrafted. In contrast to our cloches made of borosilicate glass (page 179), these items are made of a massive glass drop. Therefore air inclusions and minor streaks cannot be avoided completely. Each cloche is unique, the result is a harmonic enlivenment of the buffet for an attractive price.



Charger plates

The saucer made of china and the suitable cloche is available on page 184, more items of the series "Capiz" on pages 65 and 168.

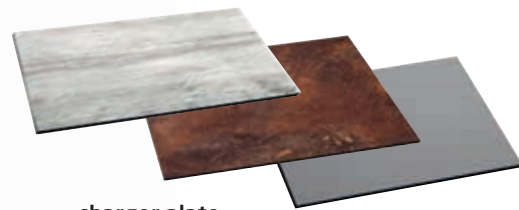

charger plate

laminated plastic, 8 mm thick, black intermediate ply, break-proof, scratch-proof, dishwasher-safe, antistatic, square, deburred edges, rounded corners

item	version	l x w in cm
8001.06	matured wood look, white	34x34
8007.06	rusted look	34x34
8006.06	dark grey	34x34

The cloche item 4982.11 and the saucer 4398 are available on page 182.



charger plate

natural slate, approx. 5 mm thick, food-safe (sealed), not dishwasher-safe, with rubber feet

item	version	l x w in cm
2543.30	square	30x30
2544.30	rectangular	30x20



charger plate "Ice"

glass (crimped glass chips), white, round, bevelled edge, dishwasher-safe

item	Ø in cm	height in cm
5760.35	35	2



charger plate "Ice"

glass (crimped glass chips), white, square, bevelled edges, dishwasher-safe

item	l x w x h in cm
5761.33	33x33x2

Please note the care instructions: suitable for cold and dry food, not dishwasher-safe.



charger plate "Capiz"

shell, ivory-coloured, organically shaped, resin-coated, not dishwasher-safe

item	Ø in cm	PU
7100.36	36	2 pcs

item	Ø in cm	PU
7115.36	36	2 pcs

The complete "Ice" series is available on page 169.



Charger plates





"DressCoat" is available on pages 148 and 149.



charger plate, clear glass

hardened clear glass, 6 mm thick, edge polished and deburred

item	Ø in cm
4999	33



charger plate

special hardened safety glass, 4 mm thick, edge polished, dishwasher-safe, rubber feet included (adhesive), underside scratch-proof

item	version	Ø in cm
1669.33	black glass	33
1671.33	white glass	33



charger plate

special hardened safety glass, 4 mm thick, rounded edges, polished rim, dishwasher-safe, rubber feet included (adhesive), underside scratch-proof

item	version	l x w in cm
1668.06	black glass	34x34
1668.10	black glass	30x18
1670.06	white glass	34x34
1670.10	white glass	30x18



charger plate

hardened glass, grey transparent, square, irregularly coloured in a cloudy look, underside structured, dishwasher-safe, scratch-proof

item	l x w in cm	thickness in mm
8008.06	34x34	5

The complete "Artisan" series is available on pages 84 and 85.



charger plate "Artisan"

stainless steel 18/10, inside polished, outside matt finish, round, hammered rim with golden adornment (brass), utility space smooth finish

item	Ø in cm
2375.33	33

The double-walled bowl item 4956.01 is available on page 219.



The creamer is available on page 216.



Wine glasses & more



Uniqueness in practice

"Many decanters provide a fast but completely unbalanced development of wines because the wines develop only by a macro-oxidation at the surface. It's more balanced and harmonic to implement the necessary oxygen in a very soft and gentle way. The filigree rays of the centric star animate the served wine to a very soft enhancement. During the swirling the oxygen is mildly folded in and integrated into the wine. Thus the wine starts to develop on its own terms and not – as with other decanters – just at the surface.

The swirling of the wine is a fascinating view and helps in a three-dimensional development to harmonize the acid and to synchronize different levels of aroma.

By using borosilicate glass as raw material for this decanter, which sticks out by its extremely smooth surface, another highly pleasant effect is, that the aromatic molecules aren't expelled from the wine but allowed to present themselves completely in the wine glass. The aerated wine becomes extremely balanced, carefully crafted and centered. An additional value which is simply priceless!"

Silvio Nitzsche, WEIN|KULTUR|BAR Dresden



Please note:
The ideal charge to provide a maximum of oxygen is 0.375 ltr.

The glass series VISION is available on pages 194 to 200.



decanter/carafe "Star"

crystal glass, transparent, handblown

item	Ø in cm	height in cm	content (bowl) in l
4945	11.5	24	approx. 0.7

decanter/carafe "Star"

in black gift box

item	Ø in cm	height in cm	content (bowl) in l
4945.PB	11.5	24	approx. 0.7



decanter/carafe "Star" with VISION "Straight"

including:

1 decanter/carafe "Star"
borosilicate glass, Ø 11.5 cm, height 24 cm, content bowl approx. 0.7 l

2 wine glasses VISION "Straight"
crystalline glass, transparent, handblown, Ø 9 cm, height 27 cm, content 540 ml
1 set in black gift box

item	PU
4946.PB	1 set (3 parts)

Care instructions:

Looking at "Star" almost everybody, who already gained experience with decanters, will intuitively ask how to clean it. Many decanters have the nature, in particular when used for red wines, to absorb the colour pigments and to show light grey or brown surface layers after a certain usage. Most of these carafes have microscopically seen a rough surface which leftovers of the wine might adhere to and cause an unattractive appearance of the decanters. With our decanter, made of borosilicate glass, this effect might appear after a much longer period due to the extremely smooth and repellent surface of this high-quality laboratory glass. In case it actually happens these traces can easily be removed by using a mixture of citric acid and water. After a 2 hour residence time the problem should be solved.

"Star" - the art of decantation



The decanter „Star“ synergizes the aesthetics of a unique copy with the functionality of a professional tool for vinophile pleasure.

Based on products by glassblower Detlef Greiner-Perth and presented by Silvio Nitzsche, "Star" is possibly the most fascinating wine carafe in a long time due to its exceptional design.

A masterpiece of craftsmanship is the star positioned inside the decanter. Besides the positive influence this object has on the development of the wine, it attracts in an almost magical way the glances of the beholder. Thus "Star" moves into the center of attention and awards the enjoyment of wine at home but also the service in a restaurant a perceived value.

The individual star raises each carafe to a unique piece and thus creates a fascinating basis for conversation with interested guests.

This artfully created centerpiece becomes a unique element in an excessively complex multi-stage process. This is pure luxury in our uniform world because not a single star is of the same kind.

Due to its reduced size the small decanter is particularly suitable for the decantation of open wines or small bottles. **The ideal charge to provide a maximum of oxygen is 0.375 ltr.** A larger version for 0.75 litre bottles is in preparation.

Also for the staging of innovative high-end cocktails, flavoured spirits to the point of exotic juices this unique product is the perfect solution.

Idea: Detlef Greiner-Perth

"Eddy"

As opposed to most of the decanters available on the market, the raw material of this development aid worker for wine is not crystal glass, but high-grade and robust borosilicate glass. This type of glass, which stands out due to its dense structure, extraordinary transparency and hardness, was the precondition for the implementation of the introversive swirl elements. In an interplay with light and the contained wine, they create also visually interesting colour reflections and formal, almost graphic effects. The volume of this respirator has been dimensioned in a way that, with a filling of up to 1.5 litres, the extension of the wine's surface becomes as large as possible. Due to the complanate bottom the decanter stands safely and straight, the enclosed base made of finely structured matt black silicone also allows an inclined positioning.



decanter/carafe "Eddy"

borosilicate glass, transparent, handblown

item	Ø in cm	height in cm	content in l
4883	17	33	approx. 2.3



pedestal/ring

silicone, Ø 13.4 cm, optionally available pedestal for positioning the decanter item 4883 at an angle

item	colour	PU
4682.S	black	3 pcs
4682.W	white	3 pcs



decanter/carafe "Eddy" with ring

set consists of:

decanter made of borosilicate glass, transparent, handblown, approx. 2.3 l content

ring made of silicone, black, 1 set in black gift box

item	Ø in cm	height in cm	PU
4884.PB	17	35	1 set (2 parts)



For further information about „Eddy“ please visit:
www.zieher.com/en/highlights/eddy

"Eddy" - development aid worker

"The decanter "Eddy" defines the world of extreme wine instruments in a completely new way. Outstanding functionality combined with a language of design on an aesthetic level, which has seldom been achieved for wine instruments in such a fascinating way. It is amazing which matchlessly fast-paced development of structure each wine, no matter if red, white or rosé, experiences in this respirator. Once rotating in this texture stimulator, the wine - within seconds - runs through a development, which leads to an oxidation reaction of several hours, due to the thousandfold swirls at the conical indentations."

Silvio Nitzsche - WEIN | KULTUR | BAR - Dresden, Germany

Design: Silvio Nitzsche



The optionally available drying rack made of highly polished stainless steel (item 8014.20PB, page 201) facilitates the drying of the decanters after rinsing. Non-skid caps ensure a safe stand and keep the decanter in the desired position.



“YOU HAVE NEVER SEEN WINE LIKE THIS!”

Silvio Nitzsche, WEIN | KULTUR | BAR Dresden



“I realized in the very first moment, when taking the first sips out of these glasses, that the VISION glasses are something very special. The glasses appear distinctively light and precious and are a real eyecatcher, but this is of minor importance to me. The crucial point is that even the taste of the best wine can be enhanced by drinking it out of the proper VISION glass.”

HERMANN PFLAUM, PEGNITZ

Franconian top chef and author of cooking books, founder of the legendary “Pflaums Posthotel”, Pegnitz, co-founder of the nouvelle cuisine and of the “German Academy for Culinary Studies”.

“From the very beginning we have been excited by the appearance and the design of the glasses. But after the first degustation we have been enthusiastic! We did not want to stop tasting. The wine simply gains a different character. The BALANCE glass makes decanting superfluous - and a Grappa out of the RICH glass is simply a great experience!”

THOMAS DÖTZER, BAYREUTH

Top chef in Bayreuth, food stylist, wine expert and entrepreneur
www.doetzers.de

“My whole team and I are convinced that the beautiful glasses of the VISION series represent a new league of wine glasses. We also receive a lot of positive feedback from our guests.”

GÜNTER SEEGER, NEW YORK

The restaurant “Gunter Seeger” in New York City has been awarded multiple times by: Michelin Star and James Beard Award.

www.gunterseegerny.com



For further information about the VISION series, philosophy and far-reaching analysis of the sommelier Silvio Nitzsche please visit www.zieher.com/en/highlights/vision

VISION





For further information about the VISION series, philosophy and far-reaching analysis of the sommelier Silvio Nitzsche please visit www.zieher.com/en/highlights/vision



skillfully handblown

VISION



FRESH

RICH

STRAIGHT

BALANCED

INTENSE

NOSTALGIC

"YOU HAVE NEVER SEEN WINE LIKE THIS!"

Silvio Nitzsche, WEIN | KULTUR | BAR Dresden

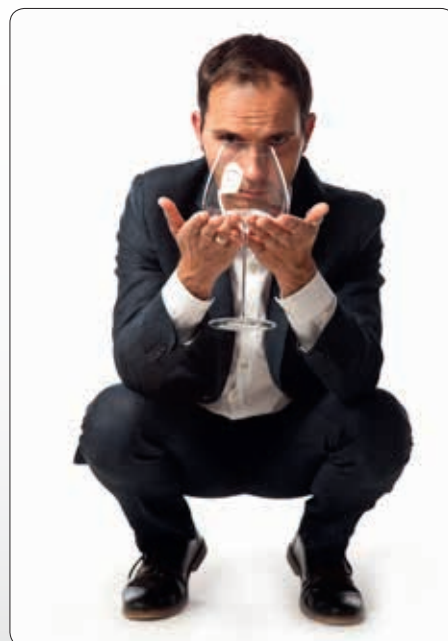

The Life and Work of Silvio Nitzsche

"Of course, there is life without wine, but who wants that?"

During a career as a sommelier, which has spanned more than twenty years, Silvio Nitzsche has looked after both guests and wine in some of the best Michelin-starred restaurants. Some of his high-profile positions have been:

- Sommelier at "Dieter Müller Restaurant" (19.5 GM, *** Michelin), Bergisch Gladbach / GER
- Sommelier at "Erna's Elderberry House", Oakhurst / CA, USA
- Assistant Restaurant Manager and Sommelier at "Speisemeisterei" Restaurant (18 GM, ** Michelin), Stuttgart / GER

Silvio Nitzsche has now found a new home in the city of Dresden, where he has worked as a sommelier for over ten years at WEIN | KULTUR | BAR, which he opened there. He and his team have managed to establish a wine bar that many wine enthusiasts consider to be one of the best in Europe. He has succeeded in creating a place where wine is a permanent feature.

In 2018 Silvio Nitzsche has been voted one of the ten best sommeliers in Germany by the magazine "Der Feinschmecker".

www.weinkulturbar.de

Filigree Craftsmanship meets Innovative Design

"Zieher glasses are all about top quality craftsmanship, which is created in one of the most innovative and best glass blowing workshops in the world. Each glass is unique and has been created from lead-free crystalline glass using a traditional glass-blowing method.

As well as having a perfect, highly sophisticated and fascinating design, the glasses in the VISION range are guaranteed to provide maximum aroma and optimum development of the wine. However, it is particularly the fascination of the light, the colours and the visual depth that make it impossible to tear your eyes away from the glass, because: You have never seen wine like this!"

The Vision

"No distinction is made between red wine or white wine glasses in this collection, the glasses are simply theme-based or character-based. The names of the glasses clearly explain what they are used for: You intuitively reach for the glass which in the best way presents the flavours of the wine that you particularly wish to emphasise. If you want a powerful wine to be more harmonious or a touch more lively and fresh, you pick the glass with the designation that mirrors your requirement best."

Silvio Nitzsche

The Zieher Food - VISION

The series VISION is predestined for wine and has been created to perfectly represent its different facets. In addition to this, the glasses offer an extraordinary platform for small delicacies or complimentary dishes from the chef. The harmonic wavy shape of the bottom creates an eye-catching ring when filled with spume or liquids. The depression in its centre provides space for amuse bouches or decorative highlights.



For distributors: Sample case VISION item 5661.01. We will be happy to inform you!



FRESH

crystalline glass, transparent, handblown

item	Ø / height in cm	content in ml	PU
5480.01	8 / 24	approx. 340	2 pcs

For extremely fresh white wines, Prosecco or any variety of sparkling wine, and light rosé wines

The wide opening of this glass allows the carbon dioxide in sparkling wines to gently evaporate. This prevents the aroma perception of the nose from being broadsided by a concentration of carbon dioxide, which is often the case with classic sparkling wine glasses. The glass provides the palate with a centralised aroma concentration, which allows the wine to express its exquisitely lively, refreshing and light character. The development of the flavour-carrying, freshly acidic structures is encouraged, and individual features of the bouquet are brought into focus.

STRAIGHT

crystalline glass, transparent, handblown

item	Ø / height in cm	content in ml	PU
5480.02	9 / 27	approx. 540	2 pcs

For pure grape varieties and fruity / aromatic red and white wines

The characteristics of the wine are reflected harmoniously one-to-one in this glass. The authenticity of the aroma culture of a grape variety is made discernible and presented in an unpretentious way, which makes this glass particularly suitable for all types of authentic grape varieties such as Riesling or Sauvignon Blanc. Light, aromatic red wines are transformed into pure drinking enjoyment.

INTENSE

crystalline glass, transparent, handblown

item	Ø / height in cm	content in ml	PU
5480.03	10.5 / 28	approx. 640	2 pcs

For opulent, great growth, powerful white and red wines, rustic, acidic white and red wines, young and middle aged Bordeaux wines

The tapering neck of this glass intensifies the aroma molecules, which are positively hurled out of the glass. The acidity is harmoniously structured in the fruit bouquet, and completes the opulent overall sensation of strength. The glass provides intensive oxidation, making it ideal for any wine that can be decanted or served in carafes.

BALANCED

crystalline glass, transparent, handblown

item	Ø / height in cm	content in ml	PU
5480.04	12 / 25	approx. 850	2 pcs

For white and red Burgundy, great Piedmontese wines, highly complex but sensitive white and red wines, extremely opulent rosé wines and old vintage champagne

A perfect glass for wine that is not for decanting because of its sensitive structure, but still requires a great deal of air. This crystal emanates pure consonance. Even with discordant wines, it succeeds in creating a concentrated and highly elegant impression. This glass turns wine into a complete aromatic experience, without overdoing it.

RICH

crystalline glass, transparent, handblown

item	Ø / height in cm	content in ml	PU
5480.05	7 / 23	approx. 280	2 pcs

For fortified, sweet and dessert wines and any type of distilled beverages

A glass for the majority of heavyweight or high-proof drinks. The small presentation surface ensures that the wine or brandy does not become overly concentrated, so that the heavyweight aromatic elements are released in a nuanced way. Due to the glass having a narrow opening, the nose cannot go in very far, which prevents the perceiving mucous membranes from receiving a barrage of alcohol.

NOSTALGIC

crystalline glass, transparent, handblown

item	Ø / height in cm	content in ml	PU
5480.06	10.5 / 16.5	approx. 250	2 pcs

For mineral water, cocktails, or as a food glass

A glass which manages to distinguish any mineral water with its extremely open chalice design, which appeals to an extensive palate. The acids and the individual, extremely fine mineral elements of the water are delivered to the tongue and the palate in a refreshing way. At the same time, the carbon dioxide is harmonised and has an extremely refreshing effect, but avoids being penetrating, flavour-destroying or intrusive.

For the series VISION we recommend the CAMBRO - Camrack® Warewashing System

The Camrack® Warewashing System will protect your valuable stemware and tumblers not only during washing, but also during stacking, storage and transportation. This helps to avoid costs related to damaged glasses. Detailed information about the Camrack® Warewashing System is available at www.cambro.com.

Camrack® 4-in-1 Warewashing System

- Efficient washing
- Optimum sanitary storage
- Inventory control
- Safe, sanitary transportation

Camrack® Warewashing System

Cambro® offers a 4-in-1 system where glassware is washed, stored, identified and transported in one single unit. This multipurpose unit involves the Camdolly®, Camrack® compartment racks and the Camrack® cover.

item racks	number of compartments	max. height	max. Ø	rack height	for item	name
25S958	25	25.8 cm	8.7 cm	30.8 cm	5480.01	FRESH
20S1114	20	30 cm	9.8 cm	34.9 cm	5480.02	STRAIGHT
16S1114	16	30 cm	10.9 cm	34.9 cm	5480.03	INTENSE
9S958	9	25.8 cm	14.8 cm	30.8 cm	5480.04	BALANCED
30S958	30	25.8 cm	7.9 cm	30.8 cm	5840.05	RICH
16S638	16	17.4 cm	10.9 cm	22.5 cm	5480.06	NOSTALGIC



Accessories - Dolly and Cover



Camdolly®

item	l x w x h in cm	colour
CDR2020	54.3x54.3x20.3	soft grey (151)



Camrack® Cover

item	l x w x h in cm	colour
DRC2020	50x50x2.4	grey (180)



VISION

"Pebble" is made of high-grade lead free crystal glass.

The unfilled decanter inspires by the brilliance of the glass alone and the resulting light refexions.

These products are hand-blown with perfect craftsmanship. The sensitivity and long years of experience of the glass blowers become apparent in particular in the creation of the bottom, which is extensively dimensioned and separated into three convex segments.



decanter/carafe "Pebble"

crystal glass, transparent, handblown

item	Ø in cm	height in cm	content in l
4890	20	30	approx. 1.8

decanter/carafe "Pebble"

in black gift box

item	Ø in cm	height in cm	content in l
4890.PB	20	30	approx. 1.8



decanter dry rack "Stablo"

stainless steel 18/10, polished, suitable for decanters "Eddy" and "Pebble"

item	Ø top/bottom in cm	height in cm	PU
8014.20PB	15/23	20	1 pc



"Pebble" **NEW**

Design: Itamar Harari

While filling the decanter the wine flows, due to the shaping of the neck, along the complete inside area, which maximizes the surface of the wine and thus contributes to the aeration.

The three swales at the bottom serve to further swirl the poured wine which results in a gentle but nevertheless very effective aeration. This effect can be intensified by warily swinging the filled decanter. Furthermore the three bulges at the bottom provide a wiggle-free and safe stand.

The diagonal cut of the neck and the accurate polish of the raw edges minimize the formation of drops while pouring out.

The optionally available drying rack made of solid stainless steel facilitates the drying of the decanters after rinsing. Non-skid rubber caps ensure a safe stand.

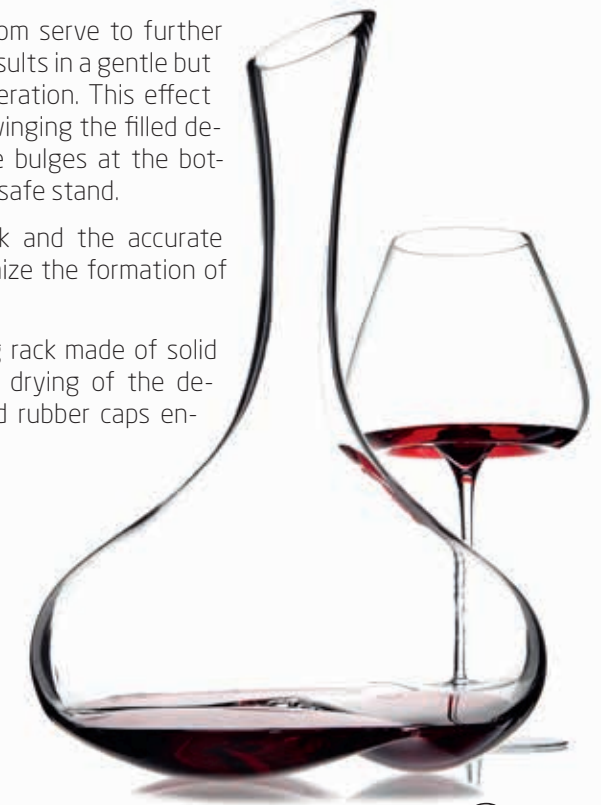

VAGANZA



The filigree champagne flute "Vaganza" is handblown and created in superior handcraft by experienced glassblowers. The result of this work is a crystal glass of highest craftsmanship. "Vaganza" captivates by its slim silhouette and elegant shape that bestows an exclusive character on the glass. The versions coated in gold or platinum fascinate with brilliant colours and the luxurious appearance of the applied decors. "Vaganza" seduces by its charming lightness and adds a touch of high society to any event.



champagne flute "Vaganza"
crystalline glass, handblown, Ø 5 cm, 33.5 cm high,
210 ml content, in black gift box

item	colour	PU
5481	transparent	2 pcs
5481.GPB	gold	2 pcs
5481.PPB	platinum	2 pcs



Miniatures



"Good taste is the art of understanding small things."

Rousseau

"Cuspis"



glass spoon "Cuspis"
borosilicate glass, transparent, handblown, with star-shaped ball handle

item	l x w x h in cm	PU
4941.01	approx. 7x4x3.5	6 pcs



honey spoon "Cuspis"
borosilicate glass, transparent/white, handblown, star-shaped, please note the safety instructions on each pack

item	length in cm	PU
4942.01	16	4 pcs



small glass bowl/glass tray
glass, deep black, rectangular

item	l x w x h in cm	PU
5167	11.5x5.5x1.5	12 pcs



honey spoon with glass tray "Cuspis"

set consists of:
honey spoon made of borosilicate glass, transparent/white, handblown, star-shaped
tray made of glass, deep black, rectangular
1 set in black gift box

item	l x w x h in cm	length (spoon) in cm	PU
4944.PB	11.5x5.5x1.5	16	1 set (2 parts)



glass cloche "Cuspis"

borosilicate glass, transparent, handblown, star-shaped ball handle

item	for plate/bowl	Ø in cm	height in cm
4940.08	4389.09	8.5	12.5
4940.10	4389.11	10.5	14.5



plateau plate/small bowl "Cuspis"

china, white, inside and useable area (plateau Ø approx. 6 cm/8 cm) glazed, outside biscuit, also useable as a bowl

item	Ø in cm	height in cm	content in l
4389.09	9	3	0.1
4389.11	11.5	3.5	0.18



cloche with plateau plate/ small bowl "Cuspis"

set consists of:
cloche made of borosilicate glass, transparent, handblown, with star-shaped ball handle
plateau plate made of white china, inside and useable area glazed, outside biscuit, useable on both sides,
1 set in black gift box

item	Ø in cm	height in cm	PU
4943.08PB	9	approx. 14/14.5	1 set (2 parts)
4943.10PB	11.5	approx. 17/17.5	1 set (2 parts)

"Cuspis"



The large cloche "Cuspis" and the suitable plateau plate are available on page 142.

Borosilicate glass in its most beautiful shape!

The primary design element of the series "Cuspis" is a glass ball studded with fine spikes. The cloches with a fitting porcelain plateau plate/mini bowl are available in three sizes and the inspiration for their shaping was derived from the nut of the oak tree. The star-shaped handle is located at the top of the cloches and allows for an uncomplicated handling of these classy covers. The unglazed outside of the porcelain bowls is reminiscent of acorn caps. The bowls can be used on both sides. When used as a plateau plate, the dishes move closer to the guest, while the filigree glass cloche protects the presented delicacies and puts them in the limelight at the same time. Used as a bowl, it offers space for gravies, sauces and more. Amuse-bouches and any kind of finger food can be served on the series' shapely amuse gueule spoons. In this case the glass ball serves as a secure handle. The capacity of the spoons is sufficient for a usage with sauces or dips on the plate, but also at the breakfast buffet for jam and the like.



A honey spoon of a different kind reliably holds the honey and, while being twirled, will deliver it drip-free onto the fresh bread or into the tea. The tapering handle made of white borosilicate glass additionally offers the use as a skewer - for an extravagant presentation of dishes. The gift set includes a tray made of black glass, which keeps the surface of tables clean and emphasizes the spoon by creating an appealing contrast. The tray is also available separately.



The glass pillow "Donna" is available on page 145.





chopsticks

borosilicate glass, satined, handmade, please note the safety instructions on each pack (not suitable for children)

item	length in cm	PU
4885	21.5	1 set (2 parts)



chopstick/knife rest "Flex"

borosilicate glass, transparent, handmade

item	l x w in cm	height in cm	PU
4886	8x2.3	approx. 2	2 pcs



chopsticks with knife rest

set consists of:
chopsticks, borosilicate glass, satined, handmade
knife rest, borosilicate glass, transparent, handmade
 2 sets in black gift box

item	l x w in cm	height in cm	PU
4887PB	21.5 / 8x2.3	approx. 2 (rest)	2 sets (6 parts)



dip bowl/miniature "Flex"

borosilicate glass, transparent, handmade, with recess

item	l x w in cm	height in cm	PU
4889.16	16x7	approx. 2.8	4 pcs



platter/miniature "Flex"

borosilicate glass, transparent, handmade, wavy

item	l x w in cm	height in cm	PU
4888.16	16x8	approx. 2	4 pcs
4888.22	22x11	approx. 2.5	4 pcs



"Flex" - Perfectly designed and beautiful!

Tubes made of borosilicate glass – shaped into unique pieces by way of heat exposure. These perfectly designed elements of the "Flex" series can only be manufactured in such a sophisticated quality by extremely precise control of timing at exact temperatures.

Elegant presentation plates for amuse-bouches, fingerfood and other artfully arranged delights of upscale cuisine originate from this complex procedure. The "Flex" series is also suitable for intermediate courses or smaller desserts as well as presentations of bread and oil or dips.

The artfully curved inside of the tubes offers creative space for cutlery or napkins, decorative herbs, edible blossoms and more!

A rest for knives or chopsticks in the same language of design blends harmonically into this series. Chopsticks made of borosilicate glass are the perfect completion for this line. The satined surface of the sticks provides for pleasant haptics and creates an appealing contrast to the clear glass of the rest.



Design: Michael Schwarzmüller
 Idea and concept: Zieher

The black glass tray item 5141.26 is available on page 276.



"Lacuna"



"Lacuna"

Braving the gap!

Perforated walls, irregularly spread openings in filigree borosilicate glass - the small bowls of the series "Lacuna" stand out. Numerous holes in different sizes form the basis for sophisticated presentations of high-grade dishes. They set limits on the one hand, however offer various possibilities for creative arrangements and an extraordinary food presentation on the other.

The glass cone can be employed in three different ways. Rested horizontally and stabilized by a fork or a spoon, standing upright in various miniatures or put in elegant supports made of silicone or as an extraordinary cloche for the presentation of delicate tidbits.

Suitable accessories like anti-slip coasters made of food safe silicone or borosilicate glass straws enormously extend the scope of application of that series. Even working with small skewers for finger food may be envisaged.

Design: Michael Schwarzmüller



small bowl

china, black, matt, square

item	l x w x h in cm	content in l	PU
3855.01	4.9x4.9x7	0.11	4 pcs



glass straw

borosilicate glass, transparent, handblown, temperature resistant, please note the safety instructions on each pack of glass straws

item	Ø in cm	length in cm	PU
4980.16	0.8	16	24 pcs

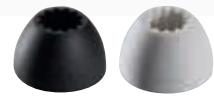

holder for test tubes

silicone, Ø 4.6 cm, 2.7 cm high, with grooves on the inside for easy insertion of glass tubes

item	colour	PU
4680.S	black	6 pcs
4680.W	white	6 pcs



glass miniature

clear glass

item	Ø / height in cm	content in l	PU
5405	5 / 8.6	0.1	6 pcs



miniature

china, stackable, Ø 5.3 cm, 7 cm high, 0.1 l content

item	colour	PU
4490	white	6 pcs
4490.01	black	6 pcs



cone "Lacuna"

borosilicate glass, transparent, handblown, with line of holes along the rim

item	Ø / height in cm	content in l	PU
4925.01	6 / 12	approx. 0.08	4 pcs



small glass bowl "Lacuna"

borosilicate glass, transparent, handblown, with line of holes along the rim

item	Ø / height in cm	content in l	PU
4926.01	12.5 / 6	approx. 0.08	4 pcs

No sliding,
no clattering ...



The china series "DressCoat" is available on pages 148 and 149.

... with the non-slip pads by Zieher!

The coasters made of food safe silicone are shapely accessories with a highly practical benefit. Clattering and wildly sliding miniatures on plates and trays are a thing of the past.

The skid-proof discs with their delicately structured, matt surface facilitate the service's work and ensure undisturbed enjoyment for the guest.

The coasters are available in two colours and diameters (5 cm and 7 cm); the white ones can be integrated discreetly, whereas the black ones can be used deliberately as contrasting, decorative elements.

The "Lacuna" series is available on page 209, the tray made of black glass on page 276.



coaster

silicone, Ø 5 cm, 3 mm thick, temperature resistant (-40 °C to +230 °C), food-safe, with rim on one side, for anti-slip placement of miniatures

item	colour	PU
4661.05S	black	24 pcs
4661.05W	white	24 pc



coaster

silicone, Ø 7 cm, 3 mm thick, temperature resistant (-40 °C to +230 °C), food-safe, with rim on one side, for anti-slip placement of miniatures

item	colour	PU
4661.07S	black	24 pcs
4661.07W	white	24 pcs



ring "SelectionA."

silicone, Ø 8.3 cm, for the anti-slip placement of small glass bowl/cloche item 5418 (page 228) and item 4930

item	colour	PU
4681.S	black	6 pcs
4681.W	white	6 pcs



small glass bowl

borosilicate glass, handblown, round

item	Ø / height in cm	content in l	PU
4930	7 / 5	approx. 0.14	24 pcs



small glass bowl

borosilicate glass, handblown, round

item	Ø / height in cm	content in l	PU
4965	11.5 / 7.3	approx. 0.6	6 pcs

These spherical bowls made of borosilicate glass accentuate in particular artfully presented dishes by their minimalistic and elegant design.

The flattened bottom of the bowls ensures a safe and even stand. Optionally available silicone rings for the small version guarantee skid-resistance and also allow a positioning at an angle.

All bowls are made of borosilicate glass, whose strength, temperature resistance, high transparency as well as absence of bubbles guarantee a high quality product experience.



4930 + 4681.S





glass miniature "Amuse"

borosilicate glass, transparent, handblown, single-walled, rim jagged

item	l x w x h in cm	content in l	PU
4924.01	13x9.5x6	approx. 0.15	6 pcs
4924.02	15x10.5x7	approx. 0.25	4 pcs

glass miniature "Amuse"

in black gift box

item	l x w x h in cm	content in l	PU
4924.01PB	13x9.5x6	approx. 0.15	1 pc. 
4924.02PB	15x10.5x7	approx. 0.25	1 pc. 



glass cloche/small bowl "Amuse"

borosilicate glass, transparent, handblown, single-walled

item	Ø / height in cm	content in l	PU
4916	9 / 6	approx. 0.2	6 pcs
4917	13 / 7.5	approx. 0.5	4 pcs

More glass cloches are available on pages 177 to 185.



Glass designer Michael Schwarzmüller puts delicious appetizers perfectly into focus. The filigree jars with their organic form offer top chefs and professional hosts the possibility of serving fingerfood and amuse-bouches in an "Amuse"-ing way.

"Amuse" wants to inspire imagination and stimulates playful experimentation. This series made of thin-walled, strong and heat-resistant borosilicate glass comprises of a variation of beautifully handcrafted cups, bowls, cloches and remarkable glass tins. The latter are perfectly suitable for the presentation of small soups and desserts, but may also be used as exceptional sugar bowls. The exact fitting lid ensures the protection and hygiene of the content. The double-walled bowls of the series in fact absorb heat or cold.

Please note: since all glasses of this series are handblown, deviations from the declared content may occur.

Design: Michael Schwarzmüller



"Amuse"



glass miniature "Amuse"

borosilicate glass, transparent, handblown, double-walled

item	Ø / height in cm	content in l	PU
4914	8.5 / 7.8	approx. 0.19	6 pcs

glass miniature "Amuse"

in black gift box

item	Ø / height in cm	content in l	PU
4914.PB	8.5 / 7.8	approx. 0.19	1 pc.



glass miniature "Amuse"

borosilicate glass, transparent, handblown, double-walled

item	Ø / height in cm	content in l	PU
4915	11.5 / 6.5	approx. 0.25	6 pcs

glass miniature "Amuse"

in black gift box

item	Ø / height in cm	content in l	PU
4915.PB	11.5 / 6.5	approx. 0.25	1 pc.

The single-walled bowls are available on page 212.



Design: Michael Schwarzmüller



glass tin "Amuse"

borosilicate glass, transparent, handblown, with lid (black handle, height without lid: 7 cm), 6 feet of glass, in black gift box

item	Ø in cm	height in cm	content in l
4918.PB	6.5	11	approx. 0.14



glass tin "Amuse"

borosilicate glass, transparent, handblown, with lid (black handle, height without lid: 9.5 cm), 6 feet of glass, in black gift box

item	Ø in cm	height in cm	content in l
4919.PB	8	13.5	approx. 0.28



glass tin "Amuse"

borosilicate glass, transparent, handblown, smooth, with lid (black handle, height without lid: 6.5 cm)

item	Ø in cm	height in cm	content in l
4920	8	10	approx. 0.22

glass tin "Amuse"

in black gift box

item	Ø in cm	height in cm	content in l
4920.PB	8	10	approx. 0.22



glass tin "Amuse"

borosilicate glass, transparent, handblown, smooth, with lid (black handle, height without lid: 5.5 cm)

item	Ø in cm	height in cm	content in l
4921	9	9	approx. 0.24

glass tin "Amuse"

in black gift box

item	Ø in cm	height in cm	content in l
4921.PB	9	9	approx. 0.24



"Amuse"



4920 + 5145

The glass tray and more suitable inserts are available on pages 276 and 277.

Double-walled thermo-glasses



The plate of the "SelectionA." series is available on page 158, the charger plate made of glass on page 188.



small glass creamer

borosilicate glass, transparent, handblown, handle curved and amber-coloured (approx. 7 cm long)

item	Ø / height in cm	content in l	PU
4995	6 / 5	approx. 0.1	4 pcs



small glass creamer "Amuse"

borosilicate glass, transparent, handblown, single-walled, Ø opening on top approx. 3 cm

item	Ø / height in cm	content in l	PU
4922	8.5 / 8	approx. 0.25	6 pcs



nut bowl "Amuse"

borosilicate glass, transparent, handblown, single-walled, Ø opening on top approx. 3.5 cm

item	Ø / height in cm	content in l	PU
4923	8.5 / 8	approx. 0.2	6 pcs

nut bowl "Amuse"

in black gift box

item	Ø / height in cm	content in l	PU
4923.PB	8.5 / 8	approx. 0.2	1 pc. 



The glass tray is available on page 276.



Handblown, double-walled glasses made of borosilicate glass combine spectacular optics and extraordinary technical features. The vacuum between the two glasses prevents the formation of condensate on the outside of the glass when the ambient temperature is warm and the drinks are cold. The isolation effect keeps cold and warm liquids cold or warm for a longer time. Borosilicate glass by Zieher stands out due to its hardness and high temperature resistance.



Double-walled thermo-glasses



The glass platter is available on page 175.



glass miniature
borosilicate glass, transparent, handblown, double-walled

item	Ø / height in cm	content in l	PU
4901.01	6 / 5	approx. 0.08	6 pcs
4901.02	8.8 / 7.5	approx. 0.21	6 pcs



longdrink glass
borosilicate glass, transparent, handblown, double-walled

item	Ø / height in cm	content in l	PU
4908	7.8 / 15.5	approx. 0.35	6 pcs

glass straw
borosilicate glass, transparent, handblown, temperature resistant, please note the safety instructions on each pack of glass straws

item	Ø in cm	length in cm	PU
4980.12	0.8	12	24 pcs
4980.16	0.8	16	24 pcs



glass miniature
borosilicate glass, transparent, handblown, double-walled, with reinforced rim

item	Ø / height in cm	content in l	PU
4901.03	6 / 7.5	approx. 0.08	6 pcs

glass miniature
borosilicate glass, transparent, handblown, double-walled

item	Ø / height in cm	content in l	PU
4903	5.5 / 8.5	approx. 0.1	6 pcs



cocktail glass
borosilicate glass, transparent, handblown, double-walled

item	Ø / height in cm	content in l	PU
4962	10.5 / 16	approx. 0.2	6 pcs



glass tumbler
borosilicate glass, transparent, handblown, double-walled

item	Ø / height in cm	content in l	PU
4907	8 / 10	approx. 0.28	6 pcs



small glass bowl "Halfmoon"

borosilicate glass, transparent, handblown, double-walled

item	Ø / height in cm	content in l	PU
4954.01	6 / 7.5	approx. 0.08	6 pcs
4954.02	8 / 9	approx. 0.17	6 pcs
4954.03	9 / 9.5	approx. 0.21	6 pcs

small glass bowl "Halfmoon"

in black gift box

item	Ø / height in cm	content in l	PU
4954.03PB	9 / 9.5	approx. 0.21	2 pcs 





glass bowl

borosilicate glass, transparent, handblown, double-walled

item	Ø / height in cm	content in l	PU
4956.01	9 / 4	approx. 0.07	6 pcs
4956.02	11 / 5.5	approx. 0.15	6 pcs
4956.03	13 / 6.5	approx. 0.25	4 pcs
4956.04	15 / 7	approx. 0.30	4 pcs

glass bowl

in black gift box

item	Ø / height in cm	content in l	PU
4956.02PB	11 / 5.5	approx. 0.15	1 pc. 
4956.03PB	13 / 6.5	approx. 0.25	1 pc. 
4956.04PB	15 / 7	approx. 0.30	1 pc. 



small glass bowl "Halfmoon"

borosilicate glass, inside with satin finish, handblown, double-walled

item	Ø / height in cm	content in l	PU
4964	12 / 7.5	approx. 0.35	6 pcs



small glass bowl

borosilicate glass, inside with satin finish, handblown, double-walled

item	Ø / height in cm	content in l	PU
4963.01	6 / 8.5	approx. 0.05	6 pcs
4963.02	6.5 / 9.5	approx. 0.08	6 pcs
4963.03	7.5 / 10.5	approx. 0.1	6 pcs



© Copyright 2012 by Fabian Sängler
www.chocolate-culinary.com
Book title: Sweet Inspirations



plate "Modul"

china, white, square, flat, for base trays "Modul" made of walnut and melamine

item	l x w in cm	PU
4380	11x11	12 pcs

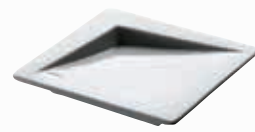

bowl "Modul"

china, white, square, deep, for base trays "Modul" made of walnut and melamine

item	l x w in cm	content in l	PU
4381	11x11	0,07	12 pcs



dip bowl for olive oil

china, white, square

item	l x w x h in cm	PU
3912	12x12x1.8	6 pcs

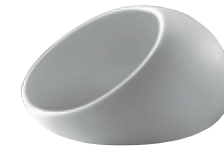

bowl "Cave"

biscuit china, white, inside glazed, opening: Ø approx. 8 cm, in black gift box

item	Ø in cm	height in cm	PU
4375.01PB	approx. 11	7	1 pc.



"Cave"

Design: Wilma Greim

Like the shell hides the pearl, the porcelain bowl "Cave" conceals precious delicacies within its hard shell. At first sight this porcelain piece only partly reveals its interior. "Cave" consists of intricately worked hard porcelain and captures by its soft shape and the velvety haptics of the unglazed outside. Touching the cave-shaped bowl it feels almost like a palm stone made of white gold, having a soft appearance with delicious contents. "Cave" is predestined for a use at cocktail and hors d'oeuvres receptions or at the flying buffet. The miniature bowl can be carried comfortably and perfectly fits in the palm of the hand.

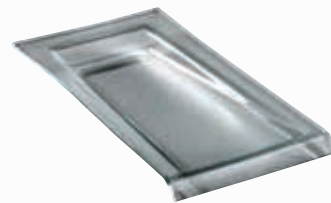

plate "Modul"

china, white, flat, rectangular, for base trays "Modul" made of walnut and melamine

item	l x w in cm	PU
4383	22x11	12 pcs

bowl "Modul"

china, white, deep, rectangular, for base trays "Modul" made of walnut and melamine

item	l x w in cm	content in l	PU
4384	22x11	0,22	12 pcs

glass plate "Modul"

glass, transparent, structured, flat, rectangular, for base trays "Modul" made of walnut and melamine

item	l x w in cm	PU
5074.01	22,5x11	6 pcs

The complete "Modul" series is available on pages 131 to 139.



cooling pack

nylon, black/white, non-toxic cooling gel

item	l x w in cm
5663.20	20x20



The glass bowls "Cave" are available on page 68.



Stay cool!

Serving chilled food is primarily a technical challenge with certain dishes or intermediate courses. With Zieher's two-coloured cooling pads, this necessity can be met in a sophisticated way, also in terms of visual appearance. The wrapper made of black resp. white nylon fabric appears classy and unobtrusive. The pads are filled with gel which remains shapeable even when frozen and thus allows an adjustment to the tableware used. The pads can also be used on the buffet. For further information please have a look at pages 42 and 43.

The glass bottles is available on page 272, the tray on page 269.

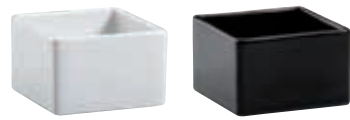

small bowl
china, square, 7 cm long, 7 cm wide, 4.5 cm high, 0.13 l content

item	colour	PU
3854	white	4 pcs
3854.01	black, matt	4 pcs



small bowl
china, white, square

item	l x w x h in cm	content in l	PU
3853	7x7x2	0.05	12 pcs



small bowl
china, white, square

item	l x w x h in cm	content in l	PU
3859	6.5x6.5x2	0.03	12 pcs



small bowl
china, white, rectangular

item	l x w x h in cm	content in l	PU
3858	13.5x6.5x2	0.07	12 pcs



small bowl
china, square, 4.9 cm long, 4.9 cm wide, 7 cm high, 0.11 l content

item	colour	PU
3855	white	4 pcs
3855.01	black, matt	4 pcs



small bowl
china, square, 4.9 cm long, 4.9 cm wide, 4.5 cm high, 0.05 l content

item	colour	PU
3845	white	4 pcs
3845.01	black, matt	4 pcs



small creamer
china, white, square

item	l x w x h in cm	content in l	PU
3849	4.9x4.9x4.5	0.05	4 pcs



small bowl
china, white, square

item	l x w x h in cm	content in l	PU
3844	4x4x3	0.03	24 pcs

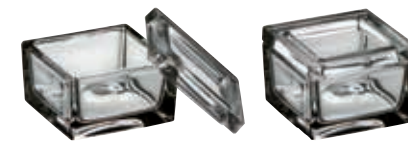

small glass bowl
clear glass, square, delivery without lid item 5338.01 (please order separately)

item	l x w x h in cm	content in l	PU
5338	7x7x3.9	0.1	12 pcs

glass miniature
clear glass, square, lid for small glass bowl item 5338

item	l x w in cm	PU
5338.01	7x7	12 pcs



small glass bowl
clear glass, square, delivery without lid item 5254.01 (please order separately)

item	l x w x h in cm	content in l	PU
5254	4.9x4.9x4.5	0.05	4 pcs



small glass creamer
clear glass, square, delivery without lid item 5254.01 (please order separately)

item	l x w x h in cm	content in l	PU
5255	4.9x4.9x4.5	0.05	4 pcs



glass miniature
clear glass, lid for small glass bowl item 5254 and glass creamer item 5255

item	l x w in cm	PU
5254.01	4.9x4.9	12 pcs



Also suitable for tealights



glass tray
clear glass, 4 deepenings (Ø 4.6 cm), for inserts and portion jam up to Ø 4.4 cm (e. g. Darbo portion jam, 28 g and 40 g)

item	l x w x h in cm	PU
5428.04	23.5x6.2x3	6 pcs



Trays and miniatures made of melamine are available on page 122.



The glass bottle is available on page 271, the box "Solid" on page 270.



Many suitable cruet stands and trays are available from page 268 onwards.

Buffet platters / charger plates made of white glass are available on page 51.



The creamer is handmade, deviations from the declared measurements may occur.



small glass creamer

clear glass, handblown

item	Ø / height in cm	content in l	PU
5416	4.7 / 9.8	approx. 0.1	6 pcs



miniature glass bottle

clear glass, round, with glass lid (round), with notched stopper for pouring with closed lid, height incl. lid

item	Ø in cm	height in cm	content in l
5741	4.3	5.5	approx. 0.03



test tube

borosilicate glass (temperature change resistant), with flanged rim and round bottom, for holder for test tube items 4680... and cork item 1501

item	Ø / height in cm	content in l	PU
4032.G	2 / 15	0.04	24 pcs

cork

for test tube item 4032.G

item	Ø in cm	length in cm	PU
1501	2.0/1.7	2.6	24 pcs



The silicone holders for test tubes are also suitable as adjustable feet.



holder for test tubes

silicone, Ø 4.6 cm, 2.7 cm high, with grooves on the inside for easy insertion of glass tubes, for test tube item 4032.G

item	colour	PU
4680.S	black	6 pcs
4680.W	white	6 pcs



glass bottle

clear glass, square, suitable cork items 5297.01 and 5297.02 (please order separately)

item	l x w x h in cm	content in l	PU
5296.01	3.9x3.9x8.5	0.04	12 pcs
5296.02	4.9x4.9x11	0.1	12 pcs



cork

plastic, ecru, for glass bottle items 5296.01 and 5296.02

item	Ø in mm	height in mm	PU
5297.01	20/10	22	24 pcs
5297.02	26/15	28	24 pcs



glass bottle

clear glass, square, with swing top (plastic and stainless steel), height incl. swing top

item	l x w x h in cm	content in l	PU
5295.01	5.4x5.4x12.5	0.1	12 pcs
5295.02	6.7x6.7x14.5	0.2	12 pcs

Its honed sides prevent the glass stopper from falling off when pouring from the closed bottle.



glass bottle/creamer

clear glass, square, with glass stopper (round), with notched stopper for pouring with closed lid, height incl. stopper

item	l x w x h in cm	content in l	PU
5740	5x5x12.5	0.12	3 pcs



glass bottle

clear glass, with swing top (PVC lid), height incl. swing top

item	Ø / height in cm	content in l	PU
5290.01	4.5 / 14.5	0.1	12 pcs
5290.02	5.5 / 19	0.2	12 pcs



small butter & lard pot

clear glass, round

item	Ø in cm	height in cm	PU
5424	9	9.5	6 pcs



Suitable cruet stands are available on page 254.



More information about "Flow"
is available on page 160.



glass bowl

borosilicate glass, flat

item	Ø / height in cm	content in l	PU
4910	10.5 / 2.5	0.18	12 pcs



glass tube "Sauce Flow"

borosilicate glass, open at the top and at the bottom

item	Ø / height in cm	content in l	PU
4990.02	5 / 5.5	0.1	6 pcs



glass tube "Soup Flow"

borosilicate glass, open at the top and at the bottom

item	Ø / height in cm	content in l	PU
4989	6.5 / 11	0.4	6 pcs

The bowls/displays of the "Fakir" series and more sizes of the glass platters are available on page 66.



coaster/glass insert

hardened clear glass, 4 mm thick, round, edge polished and deburred, with 4 transparent silicone feet

item	Ø in cm	PU
5244.09	9	6 pcs
5244.11	11	6 pcs
5244	13	6 pcs



small glass bowl

clear glass, oval

item	l x w x h in cm	content in l	PU
5422	8.3x7.3x3.4	0.05	6 pcs



glass miniature

clear glass, wavy rim, base: 0.07 l content, top part: 0.04 l content, for bridge "Modul" items 4584 and 4724

item	version	Ø / height in cm	PU
5423.01	base	6.5 / 5.5	12 pcs
5423.02	top	6.3 / 4.5	12 pcs



glass miniature, 2 parts

glass, satined, wavy rim

item	Ø / height in cm	content in l (base)	PU
5445	5.5 / 7.5	approx. 0.05	6 pcs



glass miniature

Ø 8 cm, 5 cm high, 0.13 l content

item	version	PU
5420	transparent	6 pcs
5420.01	satined	6 pcs





glass miniature

clear glass, for bridges "Modul" items 4584 and 4724

item	Ø / height in cm	content in l	PU
5405	5 / 8,6	0,1	6 pcs



The melamine tray item 4590 is available on page 126.



glass

clear glass

item	Ø / height in cm	content in l	PU
5380	7,5 / 10,5	0,32	6 pcs
5381	7,5 / 6	0,18	6 pcs

The sushi platter is available on page 170.



ring "SelectionA."

silicone, Ø 8,3 cm, for the anti-slip placement of small glass bowl/cloche item 5418

item	colour	PU
4681.S	black	6 pcs
4681.W	white	6 pcs



small glass bowl

glass, 2 layers, handmade, heavy quality, Ø 7 cm, 4,5 cm high, approx. 0,08 l content, for sushi platter item 8035

item	colour	PU
4859.07	white	6 pcs
4860.07	black	6 pcs



glass bowls "Unique"

glass, marbled, outside satined, round, Ø 10 cm, 6 cm high, content approx. 0,2 l

item	colour	PU
5180.10	white	6 pcs
5181.10	black	6 pcs



small glass bowl

borosilicate glass, handblown, round

item	Ø / height in cm	content in l	PU
4930	7 / 5	approx. 0,14	24 pcs



glass lid

clear glass, for glass bowl item 5308.11

item	l x w in cm	PU
5308.11D	11x11	24 pcs



glass bowl

clear glass, square

item	l x w x h in cm	content in l	PU
5308.08	8x8x4,5	0,14	6 pcs
5308.11	11x11x6	0,3	6 pcs

More sizes of the glass bowl are available on page 175.



small glass bowl

clear glass, oval

item	Ø / height in cm	content in l	PU
5330.08	7,5 / 3,5	0,08	6 pcs



glass platter

clear glass, oval

item	l x w x h in cm	PU
5331.30	30x9,5x2	2 pcs



3x 5330.08 on 5331.30



ashtray for cigars

optical glass, transparent, also usable as a rest for tongs or spoons, in black gift box

item	l x w x h in cm
5210	15x9x3



The complete series "Unique" is available on pages 146 and 147.



glass miniature

clear glass, for bridges "Modul" items 4584 and 4724

item	Ø / height in cm	content in l	PU
5257	7 / 10	0,08	12 pcs



glass cone

clear glass, for food display items 2194...

item	Ø / height in cm	content in l	PU
5415	3,5 / 8	0,03	12 pcs



The food display is available on page 263.



porcelain pillow "Donna"
white

item	l x w x h in cm	PU
4461.03	12.3x8x2.7	12 pcs
4461.01	16.5x11x3.5	6 pcs

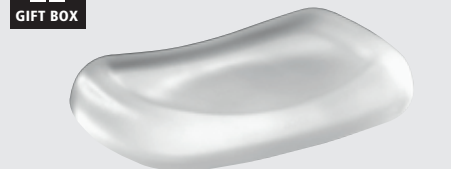

glass pillow "Donna"
glass, satined, in black gift box

item	l x w x h in cm	PU
5446.01PB	16.5x11x3	6 pcs



The complete series "DressCoat" is available on page 148.



plateau plate "DressCoat"

china, white, useable area (plateau): Ø 6.5 cm, also useable as a bowl

item	Ø / height in cm	content in l	PU
4386.02	8 / 4	0.09	12 pcs



plateau plate "DressCoat"

china, white, useable area (plateau): Ø 7.5 cm, also useable as a bowl

item	Ø / height in cm	content in l	PU
4386.01	9 / 4.5	0.1	12 pcs



miniature platter
china, white

item	l x w in cm	PU
4072.M	13x6	12 pcs



small bowl

china, white, for sauce and side dishes

item	l x w x h in cm	content in l	PU
4082	7x7x2.8	0.06	12 pcs



small creamer
china, white

item	l x w x h in cm	content in l	PU
4093	8.2x5.8x4.2	0.07	12 pcs



4081.12 + 4593 (page 274)



bowl
china, white, oval

item	l x w x h in cm	content in l	PU
4081.12	12.5x7.5x4	0.1	12 pcs



bowl "Duo"
china, white

item	l x w x h in cm	content in l	PU
4231.50	13x7x3.5	0.08	12 pcs



glass tray with bowls

set consists of: glass tray, deep black, 3 china bowls "Duo", white, 0.08 l content each, 1 set in black gift box

item	l x w in cm	PU
5135.PB	32x12	1 set (4 parts)

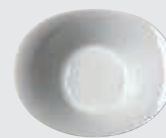

small bowl

china, white, deep, oval

item	l x w x h in cm	content in l	PU
4326.11	11x9x3.8	0.1	12 pcs



miniature plate

china, white, flat, oval

item	l x w x h in cm	PU
4324.11	11x9x1.8	12 pcs

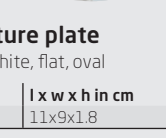

glass bowl

clear glass, oval

item	l x w x h in cm	content in l	PU
5444	12.5x7x4	0.08	6 pcs



glass bowl "Duo"

clear glass

item	l x w x h in cm	content in l	PU
5441	11.5x7x3.5	0.07	6 pcs



small glass bowl "Spobo" with spoon rest

clear glass, for spoons with a total length of 12 cm and over

item	Ø / height in cm	content in l	PU
5440	10 / 4	0.08	6 pcs



small glass bowl

clear glass, deep, oval

item	l x w x h in cm	content in l	PU
5442	11x9x3.8	0.09	6 pcs

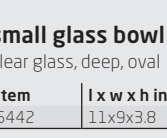

5444 + 5143 (page 276)

5444 + 4593 (page 274)



5440 + 5145 (page 276)



The stainless steel cruet stand is available on page 264.



creamer

china, white, stackable

item	Ø / height in cm	content in l	PU
4489	5.3 / 9	0.13	6 pcs



miniature

china, stackable, Ø 5.3 cm, 7 cm high, 0.1 l content

item	colour	PU
4490	white	6 pcs
4490.01	black	6 pcs



The vinegar/oil bottle is available on page 267, the cruet stand on page 273.



small bowl "Catering"

china, white

item	Ø / height in cm	content in l	PU
4499	8 / 5.5	0.2	6 pcs
4500	8 / 2.5	0.08	12 pcs



the stainless steel cruet stand is available on page 265.



small bowl

china, white

item	Ø / height in cm	content in l	PU
4498	8 / 6	0.17	6 pcs



egg cup "Catering"

china, white, high quality, stackable, dishwasher-safe

item	Ø in cm	height in cm
3977	5	5



small bowl "Catering"

china, white, high quality, stackable, dishwasher-safe

item	Ø / height in cm	content in l	PU
3962.06	6 / 3	0.03	24 pcs



The suitable etageres are available on pages 260 and 261



miniature plate

china, round, flat, Ø 10.5 cm

item	colour	PU
4606.10	white, glossy	12 pcs
4607.10	black, matt	12 pcs



plate

china, round, flat, Ø 17 cm

item	colour	PU
4606.17	white, glossy	4 pcs
4607.17	black matt	4 pcs

Cloches made of glass are available on pages 178 to 185.



coaster

biscuit china, white, inner circle glazed (Ø 9,5 cm), for round items with an inner diameter of 10.5 cm

item	Ø in cm	height in cm	PU
4398	11,5	1,3	6 pcs



miniature plate "Catering"

china, coup form, white, high quality, flat, dishwasher-safe

item	Ø in cm	PU
3954.08	8	12 pcs



Suitable cloches are available on page 181.



plate

china, black, matt, flat, round, dishwasher-safe

item	Ø in cm	height in cm	PU
3857	13.5	1.5	6 pcs



tray

stainless steel 18/10, polished, for e.g. Darbo portion jam (28 g and 40 g), portion ketchup or mustard

item	version	l x w in cm
2191.03	3 holes (Ø 4.5 cm)	19,5x7,5
2191.04	4 holes (Ø 4.5 cm)	24x7,5



miniature fork "Europa"

stainless steel 18/10, 3 mm thick, polished, excellent product quality, exceptional stability and durability

item	length in cm	PU
0405.1288	11.5	12 pcs
0405.1388	16	12 pcs



The skewer platter made of slate is available on page 239.



small skewer "Flame"

stainless steel 18/0, matt

item	length in cm	PU
1939.04	9.5	24 pcs

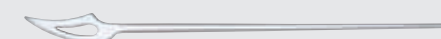

skewer "Flame"

stainless steel 18/10, polished

item	length in cm	PU
1939.02	24	12 pcs



amuse-gueule/tapas spoon "Modul"

china, white

item	l x w x h in cm	PU
4260.03	10x4x2,2	12 pcs



amuse-gueule/tapas spoon

china, white

item	l x w x h in cm	PU
4260.01	13x4x3	12 pcs



The glass platter is available on page 47.



glass spoon "Cuspis"

borosilicate glass, transparent, handblown, with star-shaped ball handle

item	l x w x h in cm	PU
4941.01	approx. 7x4x3,5	6 pcs



Suitable spoon rests made of walnut and melamine are available on pages 132 and 134.

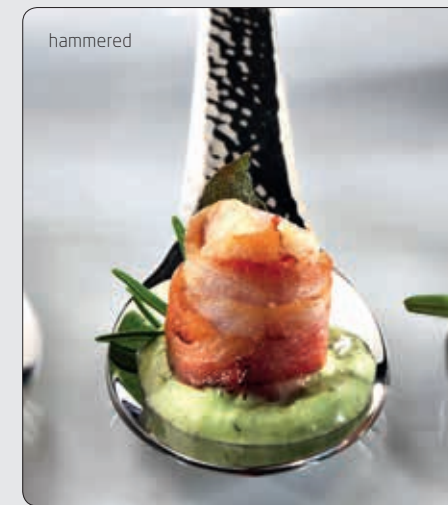

hammered



party spoon

stainless steel 18/10, 4,3 mm thick, heavy quality, 21 cm long

item	version
1938	polished
1938.01	hammered finish



honey spoon "Cuspis"

borosilicate glass, transparent/white, handblown, star-shaped, please note the safety instructions on each pack

item	length in cm	PU
4942.01	16	4 pcs



small glass bowl
clear glass, structured, rectangular, flat

item	l x w x h in cm	PU
5099	11.5x5.5x1.5	12 pcs



The "Reef" series is available on pages 62 to 64.



glass bowl
glass, 6 mm thick, dark grey, organically shaped, for bowl/basket "Reef" item 2310 (please order separately)

item	Ø / height in cm	content in l	PU
5166	13 / 6.5	approx. 0.3	2 pcs



honey spoon "Cuspis"
borosilicate glass, transparent/white, handblown, star-shaped, please note the safety instructions on each pack

item	length in cm	PU
4942.01	16	4 pcs



small glass bowl/glass tray
glass, deep black, rectangular

item	l x w x h in cm	PU
5167	11.5x5.5x1.5	12 pcs



honey spoon with glass tray "Cuspis"

set consists of:
honey spoon made of borosilicate glass, transparent/white, handblown, star-shaped
tray made of glass, deep black, rectangular
1 set in black gift box

item	l x w x h in cm	length (spoon) in cm	PU
4944.PB	11.5x5.5x1.5	16	1 set (2 parts)



The cloches are available on page 180.



small glass bowl
glass, deep black

item	l x w in cm	PU
5039.01	10x8.5	12 pcs



small glass bowl
glass, 4 mm thick, structured, dark grey, round

item	Ø in cm	height in cm	PU
5174.09	9	2.5	12 pcs
5174.11	11	3.5	12 pcs
5174.14	14	3.5	6 pcs



bowl "Artisan"
stainless steel 18/10, inside polished, outside matt finish, round, hammered rim with golden adornment (brass)

item	Ø in cm	height in cm	content in l
2371.07	7.5	3.5	approx. 0.1
2371.11	11	5.5	approx. 0.3



bowl
massive stainless steel 18/10, triangular, hammered finish, six times polished

item	Ø in cm	height in cm	content in l
a)2180.09	9	4	0.08
b)2180.13	13	6	0.28

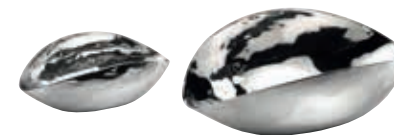

bread/pastry bowl
massive stainless steel 18/10, hammered finish, six times polished

item	l x w x h in cm
2133.12	12x7.5x4.5
2133.19	19x11.5x6.5



small bowl
massive stainless steel 18/10, round, hammered finish, six times polished

item	Ø in cm	content in l
2153	7.5	0.11



small glass bowl
glass, 4 mm thick, structured, dark grey, round, with slight corners

item	Ø in cm	height in cm	PU
5173	8	3	12 pcs



small glass bowl/spoon rest
glass, 4 mm thick, structured, dark grey, organically shaped, slightly oval form

item	l x w in cm	PU
5172	11x7.5	12 pcs

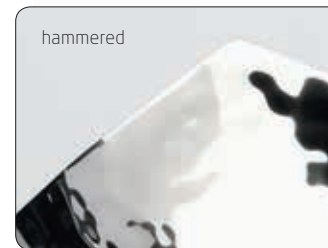

More items of the "Artisan" series are available on pages 74 and 75.



More sizes of the triangular bowls are available on page 80.





More sizes of the triangular bowls are available on page 80.



smooth



etagere

massive stainless steel 18/10, triangular, smooth finish, six times polished, not demountable

item	Ø in cm	height in cm
2187	13	16.5

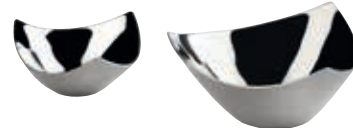

Suitable etageres are available on page 87.



NEW



The glass tray with the small bowls made of china is available on page 277, the nut bowl on page 216.

bowl

massive stainless steel 18/10, triangular, smooth finish, six times polished

item	Ø in cm	height in cm	content in l
2182.09	9	4	0.08
2182.13	13	6	0.28



small bowl

massive stainless steel 18/10, round, smooth finish, six times polished

item	Ø in cm	content in l
2153.01	7.5	0.11



bowl

massive stainless steel 18/10, oval, smooth finish, six times polished

item	l x w x h in cm	content in l
2159.16	16x10x3.5/7	approx. 0.2
2159.20	20x12x5/9	approx. 0.35

bowl

in black gift box

item	l x w x h in cm	content in l
2159.16PB	16x10x3.5/7	approx. 0.2
2159.20PB	20x12x5/9	approx. 0.35



amuse-gueule stand with foot

stainless steel 18/10, hammered

item	L x B x H in cm
2204.08	11.5 x 9.5 x 8.5
2204.11	11.5 x 9.5 x 11.5



ice cream cup with foot

stainless steel 18/10, hammered

item	L x B x H in cm	height in cm
2207.11	11.5 x 10 x 11	0.15
2207.15	13.5 x 11 x 15	0.25



New

Plateau plate



The placement of plateaus of the same height next to each other is only possible to a limited extent.



The coil shape holders and suitable inserts are available on page 88.



miniature plate with rod

massive stainless steel 18/10, hammered, polished, plate approx. 9x8 cm, for marble platter 8052 and 8022.02

item	height in cm
2203.08	8
2203.13	13
2203.18	18
2203.23	23



marble platter

black/brown, polished surface, sides rough-textured, stainless steel feet, 24 holes (Ø 5 mm), for holder coil shape items 2167... or skewer item 1939.02 or miniature plate 2203... (please order separately)

item	l x w x h in cm
8052	45x31x5



marble platter

black/brown, polished surface, sides rough-textured, rectangular, with 3 holes (Ø 5 mm), with 4 feet of felt (not dishwasher-safe), for holder coil shape items 2167... or skewer item 1939.02 or miniature plate 2203... (please order separately)

item	l x w x h in cm
8022.02	30x10x2.5



bowl

granite, anthracite, fully polished

item	Ø in cm	height in cm
8034	18	7

Design: Itamar Harari



Skewers



and more!

small skewer "Flame"

stainless steel 18/0, matt

item	length in cm	PU
1939.04	9.5	24 pcs

*Drilled holes Ø 3 mm: suitable for small skewers items 1939.04 or retail skewers made of wood



skewer plate

natural slate, not sealed, rectangular, double, with 35 holes (Ø 3 mm*), with 6 feet of felt (not dishwasher-safe)

item	l x w x h in cm
8051	35x25x2.6



8022.02 + 1939.02

skewer "Flame"

stainless steel 18/10, polished

item	length in cm	PU
1939.02	24	12 pcs

Slate is a unique and exceptional natural product. The surfaces of our slate plates have the typical slaty cleavages, therefore every piece is unique. Small deviations in structure, thickness and weight of the plates cannot be avoided because of the nature of the product. There may be single inclusions of other minerals and fossils. These extraordinary features give slate its precious and vivid appearance. Please note: Specific groceries, especially those that contain fruit acid (citric acid), may damage the surface in case of longer contact. Therefore we recommend avoiding direct contact with edibles.

Marble is a natural product, which means that the dark brown marbling can vary strongly. This is exactly what creates the vivid and unique look of this natural stone. Please note: Specific groceries, especially those that contain fruit acid (citric acid), may damage the surface in case of longer contact. Therefore we recommend avoiding direct contact with edibles. Please clean only with a wet cloth and gentle cleaners. Not dishwasher-safe. Cleaning in a dishwasher may dull the surface.

Granite is a natural product. Deviations in colour or structure are possible. Infrequently, pockets in the stone may occur. Granite is the hardest and most impervious kind of our natural stones! Sushi trays made of granite are available on page 170.



mortar

marble, black/brown, outside polished, with pestle

item	Ø in cm	height in cm
8038	20	12

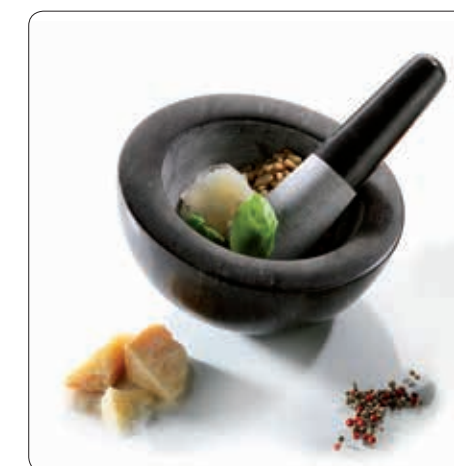

New

"Bento Box"



The champagne flute "Vaganza" is available on page 202.

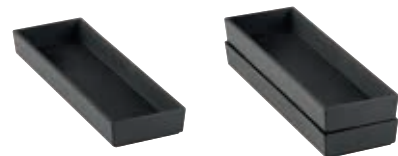

insert / box

melamine, black, surface matt, stackable, food-safe, dishwasher-safe, not suitable for microwave and combi steam oven, up to 4 pieces fit into item 4578

item	l x w x h in cm	PU
4580	29.5x9x3.3	3 pcs

The lid of the Zieher "Bento Box" can also be used as a shapely tray.



"Bento Box" - flexible mobility

Serving guests at the pool, beach or on the terrace is often associated with longer walking distances for the service staff. The „Bento Box“ from Zieher has been designed especially for these requirements - all components are stackable. This way they guarantee a space-saving storage and a comfortable, non-slip transport, even with several dishes at the same time.

Matt black melamine, modern design and subtle contrasts created by different surface structures, form the perfect setting for individual creations and popular classics such as burgers, club sandwiches or salads.

The versatility of the individual components also becomes evident in the cover, which has decorative ventilation slots to dissipate steam generated by hot food. This lid can also be used as a tray, whose less finely textured inside has an anti-slip effect.



lid / tray

melamine, black, surface matt, stackable, food-safe, dishwasher-safe, not suitable for microwave and combi steam oven, with ventilation slots, suitable for item 4578, also usable as a tray

item	l x w x h in cm
4579	39.5x31.5x4



bento box

melamine, black, surface matt, stackable, food-safe, dishwasher-safe, not suitable for microwave and combi steam oven, partition for cutlery / napkin / inserts (28 cm x 7.5 cm) or for platters (28 cm x 28 cm)

item	l x w x h in cm
4578	39x30.5x8.5

More information regarding the "Bento Box" on page 120.

Cruet stands, trays, etageres and more!



"Slope"

"Slope"

The melamine tray "Slope" is characterised by its unobtrusive shape and the pleasant feel of the matt and finely structured surface. An elevated corner and the resultant asymmetry award the tray that certain something. Besides the obvious function as a service tray for espresso, cocktails, snacks and more, it also performs well in the hotel bathroom or as a decorative trivet in the hotel room. "Slope" is available in a black and a white version and in two sizes. The robust raw material melamine appears very elegant due to its matt surface and of course it complies with demands of everyday use like food safety, dishwasher resistance as well as stackability.



VISION
from page
194 onwards



4596.30



tray "Slope"
melamine, matt, rectangular (oblique), stackable, utility
space: approx. 26 cm x 15.5 cm

item	colour	l x w x h in cm	PU
4595.30	black	30x19.5x4.2	3 pcs
4596.30	white	30x19.5x4.2	3 pcs



4595.30



tray "Slope"
melamine, matt, rectangular (oblique), stackable, utility
space: approx. 40 cm x 24 cm

item	colour	l x w x h in cm	PU
4595.45	black	45x29x4.2	2 pcs
4596.45	white	45x29x4.2	2 pcs

tray "Slope"
in black gift box

item	colour	l x w x h in cm	PU
4595.45PB	black	45x29x4.2	1 pc.
4596.45PB	white	45x29x4.2	1 pc.

4596.45



Design: Wilma Greim

"Solid"



This service tray with integrated separations is perfectly suitable for the service of small dishes at the pool, the beach or in the room. The major compartment has been designed for plates with a max. diameter of up to 29 cm, the lateral separation offers sufficient space for cutlery and napkin. Also insertion bowls with a max. width of 7.5 cm find space and thus can be used for dips, salad and other side dishes. You will find a selection of suitable inserts on page 272. The trays are equipped with integrated grip holes and they are stackable. Finger joints at the corners, non-skid rubber feet and a food-safe sealing of the solid walnut wood fulfill the high quality standards which are valid for all items of the "Solid" range.



A suitable tray stand for the roomservice tray item 4735 is available on page 286.



servicing tray "Solid"

walnut, food-safe sealed, not dishwasher-safe, stackable, 2 compartments: 30 cm x 30 cm and 30 cm x 8 cm (for cutlery or china/glass bowls), with 4 rubber feet

item	l x w x h in cm
4769	41.7x32.5x6.7



Rubber feet at the bottom that are slightly offset toward the middle enable the transport in a tray trolley in 1/1 EN-format 60 cm x 40 cm.



roomservice tray "Solid"

walnut, food-safe sealed, not dishwasher-safe, stackable, recessed on one side of the rim, with 2 handles, with 4 rubber feet, suitable for tray stand "Solid" item 4748

item	l x w x h in cm
4735	60x40x5.4



Breakfast in bed - Inroom dining!



The roomservice tray as well as the bed tray stand out due to the precious walnut which is incorporated into these products with high-quality craftsmanship. The recessed longside enables comfortable dining directly off the tray. The retractable feet of the bed tray have been constructed in a very stable way and are securely kept in position by integrated magnets when folded in. The height of the erected tray has been chosen in a way that even with soft mattresses a comfortable seating beneath the tray is guaranteed. So start off the day with a boundlessly relaxing breakfast in bed!



bed tray "Solid"

walnut, food-safe sealed, not dishwasher-safe, stackable, with feet, 2 handles, recessed on one side of the rim, in black gift box

item	l x w x h in cm (closed)	l x w x h in cm (set up)
4773.PB	60x40x6.5	approx. 74x40x31





The boxes made of walnut and more items for the hotel room are available on pages 285 to 298.



serving tray "Solid"

walnut, food-safe sealed, not dishwasher-safe, with 4 rubber feet

item	l x w x h in cm	l x w in cm (inside)
4713	34x34x3	32x32



serving tray "Solid"

walnut, flat, food-safe sealed, not dishwasher-safe, with 2 recessed grips, with 4 rubber feet, in black gift box

item	l x w x h in cm	l x w (inside) in cm
4707.PB	53x37x4	50.2x34.2



serving tray "Solid"

walnut, deep, food-safe sealed, not dishwasher-safe, 2 recessed grips, with 4 rubber feet

item	l x w x h in cm
4740	53x37x10



buffet platter

special hardened safety glass, 4 mm thick, rectangular, rounded edges, polished rim, dishwasher-safe, rubber feet included (adhesive), underside scratch-proof, for serving tray "Solid" items 4707.PB and 4740

item	version	l x w in cm
1668.03	black glass	50x34
1670.03	white glass	50x34

Suitable displays and various accessories for the service tray items 4740 and 4707.PB are available on pages 106 to 109.



"Solid" - Wood in its most beautiful shape!

Wood from the European walnut tree, which is one of the most precious and most beautiful types of wood, forms the basis for this series. Both the wood's warm brown colours in different shades and its intensive and distinctive grain make every product a unique item. The high-quality workmanship in combination with the food-safe sealing guarantees long durability, even in daily use. Please note the enclosed care instructions, not dishwasher-safe, do not immerse in water!



The bread buffet "Solid" is available on pages 106 to 111.



cutlery/napkin box "Solid"

walnut, food-safe sealed, not dishwasher-safe, with rubber feet in the lid (soft closure, can be opened to an angle of 90° only) and at the bottom, with black felt insert, stainless steel platter with space for an engraving (price and quantity upon request), height with opened lid: 15.5 cm

item	l x w x h in cm	size inside in cm
4766	28.8x11.8x6	26x8.7



cutlery box "Solid"

walnut, food-safe sealed, not dishwasher-safe, with acrylic glass lid, with 4 rubber feet, for cutlery with a length of up to 24.3 cm

item	l x w x h in cm
4720	26.5x16.2x8



Stackable in all commercial transport boxes in format 60 cm x 40 cm



"Solid"

1+2+3



1 storage/presentation box "Solid"
walnut, food-safe sealed, not dishwasher-safe, with sliding lid made of wood, also usable with glass lid item 4762.18G (please order separately)

item	l x w x h in cm	size inside in cm
4762.18	18x18x6	approx. 16x16x4.2



2 glass lid
hardened glass, brown tinted, with recess, for storage/presentation box "Solid" item 4762.18

item	l x w in cm
4762.18G	17.3x16.7

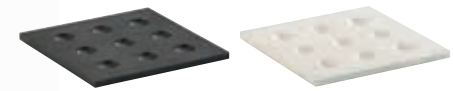

3 insert for chocolates
solid surface material, with 9 cavities (Ø 2.2 cm), for storage/presentation box "Solid" item 4762.18

item	colour	l x w x h in cm
4763.01S	black	15.8x15.8x1
4763.01W	white	15.8x15.8x1

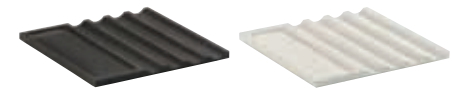

4 insert for cigars
solid surface material, for 4 cigars (grooves 1.9 cm wide), storage area for accessories (14.8 cm x 4.8 cm), for storage/presentation box "Solid" item 4762.18

item	colour	l x w x h in cm
4763.02S	black	15.8x15.8x1
4763.02W	white	15.8x15.8x1

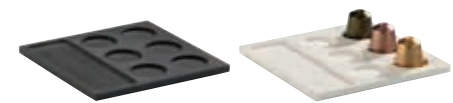

5 insert for coffee capsules
solid surface material, with 6 cavities (Ø 3.8 cm), storage area for accessories (14.8 cm x 4.8 cm), for storage/presentation box "Solid" item 4762.18

item	colour	l x w x h in cm
4763.03S	black	15.8x15.8x1
4763.03W	white	15.8x15.8x1



6 insert/platter
solid surface material, white, usable area: 14.8 cm x 14.8 cm, for storage/presentation box "Solid" item 4762.18

item	l x w x h in cm
4763.04W	15.8x15.8x1

Delicacies in delicate setting!

Due to the comprehensive range of accessories the "Solid" presentation box offers multiple application possibilities. The box, regularly fitted with a wooden sliding lid, can be equipped with several optionally available inserts made of top-quality solid surface material. The also available lid made of brown-tinted glass puts the presented goods in the limelight. Apart from an insert with round cavities for nine truffles/chocolates and a flat plate that can be used for layered chocolates, various little somethings or amuse bouches, there is also an insert available for commercial coffee capsules. The insert for cigars can hold up to four cigars and a separate compartment aside offers additional space for matches, cigar cutters, etc. No matter if it is an assortment of coffee specialities or various delicacies of the pâtisserie, the presentation box by Zieher provides the perfect setting for many purposes.

1+2+4



1+2+5

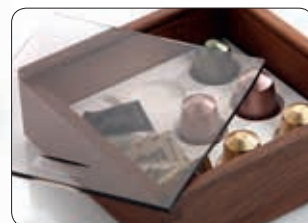

The most exquisite chocolates/truffles in an exclusive ambiance "Solid"

Finest creations of the pâtisserie have to be presented in a worthy frame!



Marco D'Andrea:

"In search of the perfect way to present my chocolates/truffles and after receiving manifold inspiration from colleagues, I have asked a carpenter of my acquaintances to manufacture some first prototypes. It was important to me that the box could be used to present jewellery and diamonds as well.

The round deepenings in the box are made out specifically that, even if the box is inclined, the truffles will not roll out. Chocolates/truffles with a diameter ranging from 22 to 28 mm fit easily into the deepenings. The dark wood of the walnut tree gives the box a fine and modern look. The brown tinted glass reveals the secrets hidden inside the box only once it is given a very close look. The glass can be inserted vertically into the back part of the box or can be slid in under the box. Once closed, anything inside the box can be stored hygienically. The narrow, side-long compartment in each box can be used individually. Besides placing a tong or other serving cutlery, it can also be used for the presentation of more chocolates or petit fours."

Idea and design for these presentation boxes "Solid" for truffles and filled chocolates are from Marco D'Andrea, pâtissier and "Junger Wilder 2012". In 2014 D'Andrea has been proclaimed "Pâtissier of the year 2014" during the "Leaders of the Year Award" convention (powered by ROLLING PIN).



Food & Design: Marco D'Andrea
(www.marcodandrea.de)



chocolate/truffle box "Solid"

walnut, food-safe sealed, not dishwasher-safe, with brown-tinted glass lid (can be used as rear wall or to slide in on the bottom side), square, 2 compartments: 1st compartment with 24 cavities for chocolates, 2nd compartment 21.3 cm x 6 cm

item	l x w x h in cm
4737	23.8x23.8x6

chocolate/truffle box "Solid"

walnut, food-safe sealed, not dishwasher-safe, with brown-tinted glass lid (can be used as rear wall or to slide in on the bottom side), rectangular, 2 compartments: 1st compartment with 48 cavities for chocolates, 2nd compartment 21.3 cm x 6 cm

item	l x w x h in cm
4738	36.8x23.8x6



chocolate/ice cube tongs
massive stainless steel 18/10, hammered finish, six times polished, 19 cm long

item	version
2138	stainless steel

Please note: the maximum filling height of the side compartment is 26 mm (when lid is closed).

"Solid"



tray "Solid"

walnut, food-safe sealed, not dishwasher-safe, for glass insert items 4708.G and 4709.G (please order separately)

item	l x w x h in cm	l x w (inside) in cm
4708	25.8x10.2x2	20.8x5.2
4709	32.5x32.5x2	28.1x28.1

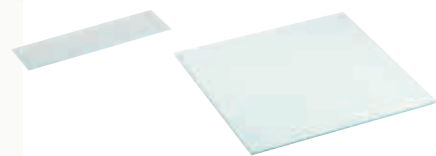

glass insert/coaster

clear glass, with 4 transparent rubber feet, for tray "Solid" items 4708 and 4709

item	l x w x h in cm	PU
4708.G	20.7x5.1x0.4	2 pcs
4709.G	28x28x0.4	2 pcs



4710 + 1669.33

serving tray "Solid"

walnut, round, food-safe sealed, not dishwasher-safe, stackable, with corrugated pattern outside

item	Ø in cm	height in cm
4710	36	4



charger plate/glass insert

special hardened safety glass, 4 mm thick, dishwasher-safe, edge polished, rubber feet included (adhesive), underside scratch-proof, for serving tray "Solid" item 4710

item	version
1669.33	black glass
1671.33	white glass



charger plate/glass insert

hardened clear glass, 6 mm thick, edge polished and deburred, for serving tray "Solid" item 4710

item	Ø in cm
4999	33



card holder

walnut, varnished, slot 2 mm wide

item	l x w x h in cm	PU
4726	8x3x3	4 pcs



bread basket "Solid"

walnut, food-safe sealed, not dishwasher-safe, boat-shaped

item	l x w x h in cm
4770.24	24.5x12x5



bowl "Solid"

walnut, round, food-safe sealed, not dishwasher-safe, stackable, with corrugated pattern outside

item	Ø in cm	height in cm
4711.18	18	6
4711.24	24	8
4711.30	30	10

The tealight holder "Solid" is available on page 282.



bowl "Solid"

walnut, oblique, food-safe sealed, not dishwasher-safe

item	Ø in cm	height in cm
4760	13	10.5
4761	14	9

Design: Itamar Harari



The bread baskets made of solid walnut wood surprise with their exceptional design and their highly sophisticated handcraft. Designing these bowls, the Milanese designer Itamar Harari did not only think of the serving of bread but also of the typical Italian Grissini. Recesses at both ends are especially suitable for those. A selection of fruit in the hotel room also receives much attention if stylishly presented in these extraordinary bowls made of beautiful wood.



"Solid"



box "Solid"

walnut, food-safe sealed, not dishwasher-safe, with 4 rubber feet, 2 compartments: 10.4 cm x 5.2 cm and 10.4 cm x 16.6 cm, for china/glass bowls (4.9 cm long and 4.9 cm wide)

item	l x w x h in cm
4703	24.4x12.4x4



box "Solid" for inserts up to 7 cm x 7 cm

walnut, food-safe sealed, not dishwasher-safe, with 4 rubber feet, 2 compartments: 14.4 cm x 7.2 cm and 14.4 cm x 14.6 cm

item	l x w x h in cm
4704	24.4x16.4x4



box "Solid"

walnut, food-safe sealed, not dishwasher-safe, with 4 rubber feet

item	l x w x h in cm	l x w (inside) in cm
4705	24.4x16.4x4	22.4x14.4

Suitable inserts made of glass and china are available on pages 271 and 272.



box "Solid"

walnut, food-safe sealed, not dishwasher-safe, with 4 rubber feet, 3 compartments: 2x 10.4 cm x 5.2 cm and 1x 10.4 cm x 16.6 cm, for china/glass bowls (4.9 cm long and 4.9 cm wide)

item	l x w x h in cm
4712	30.2x12.4x4



tray "Solid"

walnut, food-safe sealed, not dishwasher-safe, with 4 rubber feet, for china/glass bowls (4.9 cm long and 4.9 cm wide)

item	l x w x h in cm
4719	15.2x15.2x2.5

"Connect!"

Serving platters made of walnut!



cutting/snack board "Connect!"

walnut, oiled, not dishwasher-safe, pluggable, with handle, with 4 rubber feet, in black gift box

item	l x w x h in cm	length incl. handle
4774.31PB	26.5x20x2.3	31



cutting/snack board "Connect!"

walnut, oiled, not dishwasher-safe, pluggable, with handle, with 4 rubber feet, in black gift box

item	l x w x h in cm	length incl. handle
4775.44PB	40x16x2.3	44.5

Sublime in their appearance, unadorned in design, practical by compact formats and highly functional in combination - the solid wood boards of the series "Connect!" convince as a snack board, serving or cutting board, or as a presentation platter created by the combination of several elements.

"Connect!" is an extremely versatile tool for everyday use. The integrated tenon in the shape of a dovetail serves as a decorative handle with an artisanal touch. Suitable cutouts at the underside allow an easy combination of different elements. Skid-proof positioning feet ensure a firm stand, the slanted outer edges facilitate handling. The solid walnut wood is sealed with high-quality oils which makes it easy to freshen up the surface from traces of everyday wear and tear.





cloche with wooden coaster and glass insert

set consists of:
cloche made of borosilicate glass
insert made of hardened transparent glass (4 mm thick)
saucer made of walnut
 1 set in black gift box

item	Ø in cm	height in cm	PU
4882.22PB	27	approx. 37-40	1 set (3 parts)
4882.30PB	34.5	approx. 50-53	1 set (3 parts)



"Solid"



glass cloche

borosilicate glass, transparent, handblown, handmade, for coaster "Solid" items 4700...

item	Ø in cm	height in cm
4982.09	9	approx. 14-16
4982	13	approx. 20-23



coaster/glass insert

hardened clear glass, 4 mm thick, round, edge polished and deburred, with 4 transparent silicone feet

item	Ø in cm	PU
5244.09	9	6 pcs
5244	13	6 pcs



glass cloche

borosilicate glass, transparent, handblown, handmade, for coaster "Solid" items 4734...

item	Ø in cm	height in cm
4880.18	18.5	approx. 29-32
4880.22	22.5	approx. 35-38
4880.26	26	approx. 41-44
4880.30	30	approx. 48-51



coaster/glass insert

hardened clear glass, 4 mm thick, round, edge polished and deburred, with 4 transparent silicone feet

item	Ø in cm	for cloche "Solid" item
5244.17	16.7	4734.01
5244.21	20.7	4734.02
5244.24	24.2	4734.03
5244.28	28.2	4734.04



coaster "Solid"

walnut, food-safe sealed, not dishwasher-safe, stackable, for glass cloche items 4850, 4851, 4852 and 4880... and glass inserts items 5244...

item	Ø / height in cm	for cloche / insert
4734.01	23 / 3	Ø 18.5 / 16.7 cm
4734.02	27 / 3	Ø 22.5 / 20.7 cm
4734.03	30.5 / 3	Ø 26 / 24.2 cm
4734.04	34.5 / 3	Ø 30 / 28.2 cm



Please note the advice concerning the cloches on page 185.

The cloches of the series "Amuse" and more cloches made of glass and china are available on pages 178 to 185.



coaster "Solid"

walnut, food-safe sealed, not dishwasher-safe, for glass cloche items 4982... and glass insert items 5244...

item	Ø / height in cm	Ø inner circle in cm
4700.01	15.3 / 2	9.3
4700	22 / 2	13.3



The wind lights made of transparent or satinized glass are available on page 282.

Other kinds of wood upon request! (custom built)



glass cloche

clear glass, handblown, with round handle, for saucer "Solid" items 4734...

item	Ø in cm	height in cm
4850	18.5	31
4851	22.5	37
4852	26	43

Please note the care instructions for wooden items: not dishwasher-safe, do not immerse in water!

"Five o'Clock Tea"

The cloche item 4982.11 is available on page 182.



etagere/pastry stand

massive stainless steel 18/10, smooth finish, six times polished, 4-armed (6 cm distance between the trays), not demountable

item	Ø trays in cm	height in cm
2189	2x14 / 2x18	25

etagere/pastry stand

in black gift box

item	Ø trays in cm	height in cm
2189.PB	2x14 / 2x18	25

The glass cloches and more sizes are available on pages 179 to 182.



2188.27
4880.26



2188.14
+ 4982

2188.14
+ 4982.11

2188.22
+ 4880.18



tray

massive stainless steel 18/10, smooth finish, six times polished, round, with raised edge

item	Ø in cm	height in cm
2188.14	14	1.5
2188.18	18	1.5
2188.22	22	2
2188.27	27.5	2



etagere

massive stainless steel 18/10, triangular, smooth finish, six times polished, not demountable

item	Ø in cm	height in cm
2187	13	16.5



NEW

Etagere "DressCoat"

massive stainless steel 18/10, hammered, polished, 3-armed

item	Ø in cm	height in cm
2212.30	36	30

Anti-slip-rings



NEW

glass plate "Unique"

glass, white marbled, bottom satined, round

item	Ø in cm	PU
5178.21	21	6 pcs
5178.28	28	6 pcs

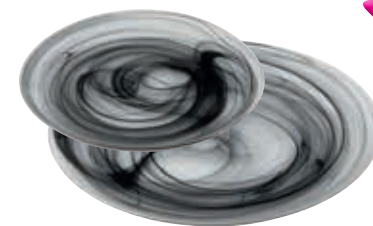

NEW

glass plate "Unique"

glass, black marbled, bottom satined, round

item	Ø in cm	PU
5179.21	21	6 pcs
5179.28	28	6 pcs

Etagere "DressCoat"

NEW



The etagere with three tiers, made of hammered and highly polished stainless steel, forms an extravagant basis for many sorts of plates and platters. A very special aesthetic set-up can be arranged by using a combination of several etageres along with the biggest plates of the "DressCoat" series (page 148).

In connection with the almost invisible tier stands the plateau plate appear amazingly airy and playful by their floating look-and-feel. A buffet presentation with an elegant vibrancy caused by the drapery of the "DressCoat" plates - that's where it comes into its own! Even in the hotel room the etageres can be positioned in an eye-catching way. Equipped with "DressCoat" or other tableware, small snacks, a selection of fruit or a sweet welcoming treat can be staged in an appealing way. All informations about this etagere are available on page 77.



You can find the plateau plate item 4388 and further items of the "DressCoat" series on page 148.



etagere
massive stainless steel 18/10, hammered finish, six times polished, including 3 removable trays item 2110.01 (30 cm long, 8 cm wide, 3 cm high)

item	l x w x h in cm (etagere only)
2110	11.5x11.5x39 (height without handle)



tray
massive stainless steel 18/10, rectangular, hammered finish, six times polished, with feet, for etagere item 2110

item	l x w x h in cm
2110.01	30x8x3



toast rack
massive stainless steel 18/10, hammered finish, six times polished, for 4 slices of toast

item	l x w x h in cm
2190	20x8.5x15



pastry tray
massive stainless steel 18/10, rectangular, hammered finish, six times polished

item	l x w in cm
2136	30x12.5



etagere with 3 tiers
massive stainless steel 18/10, hammered, polished, 21 miniature plates (approx. 9 cm x 8 cm)

item	Ø in cm	height in cm
2201	25	44.5

etagere with 3 tiers
in black gift box

item	Ø in cm	height in cm
2201.PB	25	44.5



etagere
massive stainless steel 18/10, hammered, polished, 7 miniature plates (approx. 9 cm x 8 cm)

item	Ø in cm	height in cm
2202	25	9

etagere
in black gift box

item	Ø in cm	height in cm
2202.PB	25	9



amuse gueule stand with foot
stainless steel 18/10, hammered

item	L x B x H in cm
2204.08	11.5 x 9.5 x 8.5
2204.11	11.5 x 9.5 x 11.5



ice cream cup with foot
stainless steel 18/10, hammered

item	L x B x H in cm	height in cm
2207.11	11.5 x 10 x 11	0.15
2207.15	13.5 x 11 x 15	0.25

"Flower-Tower" NEW



Design: Itamar Harari

Floral shapes in a steely gloss!

Seemingly organic shapes in an interplay with the gloss and reflections of hammered and polished stainless steel make up the special charm of this product line. Two etageres as well as plateau plates in different heights (page 89...) allow a visually harmonious yet flexible and diversified presentation of appetizers or desserts on the buffet. But also finger food, petit-fours, elaborately decorated cup cakes or a selection of pastries in the guest room find a convenient stage on these products.

The ice cream/sorbet cups and petit-fours stands in various sizes make a nice complement and individually stage appetizers or a dessert.

The formal base for all products is a slightly arched and kidney-shaped miniature plate. On three levels, the buffet etagere combines seven small plates each to a presentation platform of floral appearance and offers space to present up to 21 delicacies in a compact and stylish way. The single levels are supported by a filigree trestle made of massive stainless steel which in shape and construction deliberately readopts the design of other Zieher etageres. So nothing gets in the way of a harmonic combination of the different product lines.

The table etagere consists of one level only and is therefore perfectly suitable for the restaurant service to present intermediate courses, antipasti or dessert variations. This product is the ideal choice even as a stylish storage dish for different types of fruit or accessories of daily use.



The jam tray item 2191.04 is available on page 262.

Etageres



etagere

massive stainless steel 18/10, hammered finish, polished, with 3 or 4 insertion levels (Ø inside: 6.5 cm) for plates/bowls with max. Ø 11 cm

item	l x w x h in cm	levels
2107.03	12.5x11.5x23	3
2107.04	12.5x11.5x29	4



etagere with miniature plates

set consists of:

etagere made of massive stainless steel 18/10, hammered finish, polished, with four insertion levels (Ø inside: 6.5 cm) for plates/bowls with max. Ø 11 cm

mini plate (5 pcs incl. 1 replacement plate)
china, black, matt, round, flat, Ø 10.5 cm
1 set in black gift box

item	l x w x h in cm	PU
2106.04PB	12.5x11.5x29	1 set (6 parts)



1 miniature plate

china, round, flat, Ø 10.5 cm

item	colour	PU
4606.10	white, glossy	12 pcs
4607.10	black, matt	12 pcs



2 miniature plate "Catering"

china, coup form, white, high quality, flat, dishwasher-safe

item	Ø in cm	PU
3954.08	8	12 pcs



3 miniature plate

china, white, flat, oval

item	l x w x h in cm	PU
4324.11	11x9x1.8	12 pcs

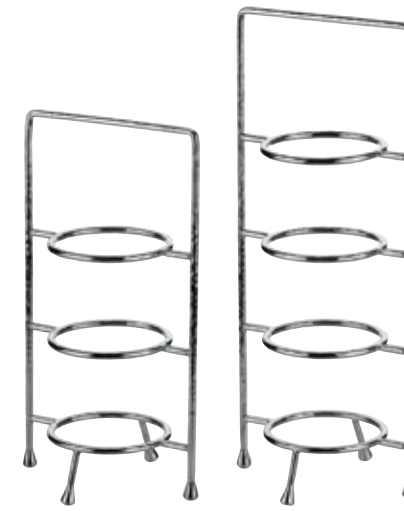

etagere

massive stainless steel 18/10, hammered finish, polished, with 3 or 4 insertion levels (Ø inside: 10.8 cm) for plates/bowls with max. Ø 17.5 cm

item	l x w x h in cm
2105.03	20.5x18x37.5
2105.04	20.5x18x47.5



etagere with plates

set consists of:

etagere made of massive stainless steel 18/10, hammered finish, polished, with three insertion levels (Ø inside: 10.8 cm) for plates/bowls with max. Ø 17.5 cm

plate (4 pcs incl. 1 replacement plate)
china, black, matt, round, flat, Ø 17 cm
1 set in black gift box

item	l x w x h in cm	PU
2103.03PB	20.5x18x37.5	1 set (5 parts)



1 plate

china, round, flat, Ø 17 cm

item	colour	PU
4606.17	white, glossy	4 pcs
4607.17	black matt	4 pcs



2 tray

massive stainless steel 18/10, square, hammered finish, six times polished, with feet

item	l x w x h in cm
2101.17	17.5x17.5x2.3



3 glass plate "Unique"

glass, marbled, bottom satined, round

item	Ø in cm	colour	PU
5178.16	16.5	white	6 pcs
5179.16	16.5	black	6 pcs

Elegantly served and presented in style - classic plate etageres, newly inspired!

Shapely and individual stands by Zieher are suitable for numerous applications. The classic plate etageres are available with three or four levels and in two sizes. The classic mini format etageres effectively present petit fours, desserts, chocolates or other delicacies. The larger versions are ideal for scones and jam during Five O'Clock Tea, but also a choice of cold cuts, cheese or fruit can be staged elaborately on the set table.



Jam-Trays



Also suitable for tealights



glass tray

clear glass, 4 deepenings (Ø 4.6 cm), for inserts and portion jam up to Ø 4.4 cm (e. g. Darbo portion jam, 28 g and 40 g)

item	l x w x h in cm	PU
5428.04	23.5x6.2x3	6 pcs



The etageres made of stainless steel are available on page 261.

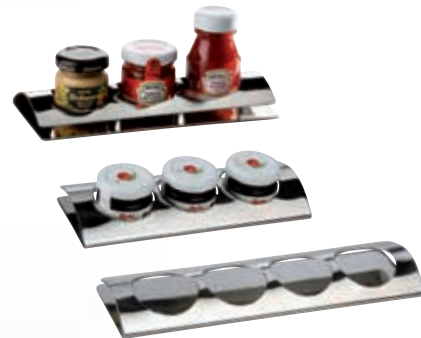

tray

stainless steel 18/10, polished, for e.g. Darbo portion jam (28 g and 40 g), portion ketchup or mustard

item	version	l x w in cm
2191.03	3 holes (Ø 4.5 cm)	19.5x7.5
2191.04	4 holes (Ø 4.5 cm)	24x7.5

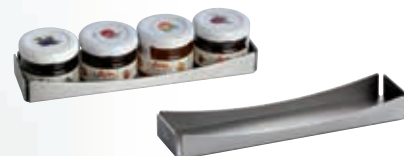

tray

stainless steel 18/10, satined, also suitable for Darbo portion jam, for inserts up to 4 cm x 4 cm

item	l x w x h in cm
2057	18.3x4.8x2



The "Fingerfood-Tree" is available on page 99.



food display

massive stainless steel 18/10, hammered finish, six times polished

item	version	l x w x h in cm
2194.03	3 holes (Ø 2.0 cm)	20x5.5x7.5
2194.06	6 holes (Ø 2.0 cm)	21x9.5x10.5



glass cone

clear glass, for food display items 2194...

item	Ø / height in cm	content in l	PU
5415	3.5 / 8	0.03	12 pcs



The test tubes and test tube holders are available on page 224.





cruet stand

stainless steel 18/10, polished, heavy quality, for inserts with a maximum Ø of 5.3 cm

item	version	l x w x h in cm
3466.02	hammered	15x11.5x21



glass miniature

borosilicate glass, transparent, handblown, double-walled, with reinforced rim

item	Ø / height in cm	content in l	PU
4901.03	6 / 7.5	approx. 0.08	6 pcs



glass miniature

clear glass

item	Ø / height in cm	content in l	PU
5405	5 / 8.6	0.1	6 pcs



egg cup "Catering"

china, white, high quality, stackable

item	Ø in cm	height in cm
3977	5	5



creamer

china, white, stackable

item	Ø / height in cm	content in l	PU
4489	5.3 / 9	0.13	6 pcs



miniature

china, stackable, Ø 5.3 cm, 7 cm high, 0.1 l content

item	colour	PU
4490	white	6 pcs
4490.01	black	6 pcs



3468.02 + 5420 + 4954.02



cruet stand

stainless steel 18/10, polished, heavy quality, for inserts with a maximum Ø of 8.2 cm

item	version	l x w x h in cm
3468.02	hammered	18.5x8.7x22



small glass bowl "Halfmoon"

borosilicate glass, transparent, handblown, double-walled

item	Ø / height in cm	content in l	PU
4954.02	8 / 9	approx. 0.17	6 pcs



small bowl "Catering"

china, white

item	Ø / height in cm	content in l	PU
4499	8 / 5.5	0.2	6 pcs



small bowl

china, white

item	Ø / height in cm	content in l	PU
4498	8 / 6	0.17	6 pcs



glass miniature

clear glass

item	Ø / height in cm	content in l	PU
5420	8 / 5	0.13	6 pcs



glass miniature

clear glass, satined

item	Ø / height in cm	content in l	PU
5420.01	8 / 5	0.13	6 pcs



3468.02 + 4954.02

Suitable vinegar / oil bottles are available on page 266.



3468.02 + 4498





Spices



vinegar/oil bottle

clear glass, with stainless steel nozzle, height incl. nozzle

item	Ø in cm	height in cm	content in l
5351	8	21	0.33



vinegar/oil bottle

clear glass, with glass stopper

item	Ø / height in cm	content in l	PU
5317	8 / 15.5	0.23	2 pcs

cork

for vinegar/oil bottle item 5317

item	Ø in cm	length in cm	PU
1502	1.7/1.4	2.2	24 pcs



cruet stand

stainless steel 18/10, polished, heavy quality, for inserts with a maximum Ø of 8,2 cm

item	version	l x w x h in cm
3468.02	hammered	18.5x8.7x22



mortar

marble, black/brown, outside polished, with pestle

item	Ø in cm	height in cm
8038	20	12



bowl

granite, anthracite, fully polished

item	Ø in cm	height in cm
8034	18	7



vinegar/oil bottle

borosilicate glass, transparent, handblown and hand-made, with 2 corks

item	content inside / outside in l	height in cm
4983	0.05 / 0.45	25



vinegar/oil bottle

borosilicate glass, transparent, handblown and hand-made, with 2 corks

item	content inside / outside in l	height in cm
4984	0.04 / 0.2	19



vinegar/oil bottle

borosilicate glass, transparent, handblown and hand-made, with 2 corks

item	content inside / outside in l	height in cm
4985	0.08 / 0.27	16.5



glass bottle/creamer

clear glass, square, with glass stopper (round), with notched stopper for pouring with closed lid, height incl. stopper

item	l x w x h in cm	content in l	PU
5740	5x5x12.5	0.12	3 pcs



miniature glass bottle

clear glass, round, with glass lid (round), with notched stopper for pouring with closed lid, height incl. lid

item	Ø in cm	height in cm	content in l
5741	4.3	5.5	approx. 0.03

Vinegar & oil



The cruet stand item 2058 is available on page 273.

Cruet stands and trays ...



4+12+13

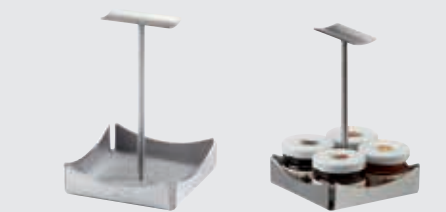

- 1** cruet stand for inserts up to 4 cm x 4 cm
stainless steel 18/10, satined, also suitable for Darbo-portion jam

item	l x w x h in cm
2056.02	9.4x9.4x13.6



- 2** cruet stand for inserts up to 5 cm x 5 cm
stainless steel 18/10, satined

item	l x w x h in cm
2056	11.4x11.4x16



3+28+29



- 3** cruet stand for inserts up to 7 cm x 7 cm
stainless steel 18/10, satined

item	l x w x h in cm
2056.01	15.4x15.4x22.5



- 4** tray for inserts up to 4 cm x 4 cm
stainless steel 18/10, satined, also suitable for Darbo portion jam

item	l x w x h in cm
2057	18.3x4.8x2

... made of stainless steel ...



Cruet stands and trays in many different sizes, variations and materials and a number of suitable inserts are summarized on pages 268 to 272. The inserts and the compartments of the trays come in three different sizes (4 cm x 4 cm, 5 cm x 5 cm and 7 cm x 7 cm) and will therefore fit for every occasion.

Start making your own combinations!

6+28+29



- 5** tray for inserts up to 5 cm x 5 cm
stainless steel 18/10, hammered, polished, rectangular, heavy quality, with wide rim

item	l x w x h in cm	l x w in cm (inside)
3467.02	26.8x11.2x2	20.8 x 5.2



- 6** tray for inserts up to 7 cm x 7 cm
stainless steel 18/10, hammered, polished, rectangular, heavy quality, with wide rim

item	l x w x h in cm	l x w in cm (inside)
3469.02	37.5x15.5x2	29.5x7



5+24

5+20+21



6+26

6+29+30

... or bread boxes made of wood ...



8+16+17+20+24



9+16+17+20+24



4705 (page 252)

7+20

11+26+27



7 box "Solid" for inserts up to 5 cm x 5 cm
walnut, food-safe sealed, not dishwasher-safe, with 4 rubber feet, 2 compartments:
10.4 cm x 5.2 cm and 10.4 cm x 16.6 cm

item	l x w x h in cm
4703	24.4x12.4x4



8 box "Solid" for inserts up to 5 cm x 5 cm
walnut, food-safe sealed, not dishwasher-safe, with 4 rubber feet, 3 compartments:
2x 10.4 cm x 5.2 cm and 1x 10.4 cm x 16.6 cm

item	l x w x h in cm
4712	30.2x12.4x4



9 tray "Solid" for inserts up to 5 cm x 5 cm
walnut, food-safe sealed, not dishwasher-safe, with 4 rubber feet

item	l x w x h in cm
4719	15.2x15.2x2.5

A suitable insert made of glass is available on page 250.



10 tray "Solid" for inserts up to 5 cm x 5 cm
walnut, food-safe sealed, not dishwasher-safe

item	l x w x h in cm	l x w (inside) in cm
4708	25.8x10.2x2	20.8x5.2



11 box "Solid" for inserts up to 7 cm x 7 cm
walnut, food-safe sealed, not dishwasher-safe, with 4 rubber feet, 2 compartments:
14.4 cm x 7.2 cm and 14.4 cm x 14.6 cm

item	l x w x h in cm
4704	24.4x16.4x4

... with suitable inserts made of glass and china ...

inserts up to 4 cm x 4 cm

inserts up to 5 cm x 5 cm

inserts up to 5 cm x 5 cm



12 glass bottle
clear glass, square, suitable cork item 5297.01 (please order separately)

item	l x w x h in cm	content in l	PU
5296.01	3.9x3.9x8.5	0.04	12 pcs

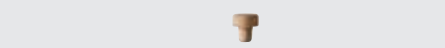

13 cork
plastic, ecru, for glass bottle item 5296.01

item	Ø in mm	height in mm	PU
5297.01	20/10	22	24 pcs



14 small bowl
china, white, square

item	l x w x h in cm	content in l	PU
3844	4x4x3	0.03	24 pcs



1+14+15



15 salt & pepper mill set
acrylic glass, square, with ceramic grinder, without filling, 5-years guarantee

item	l x w x h in cm	PU
2779	3.7x3.7x9	1 set (2 parts)



16 glass bottle
clear glass, square, suitable cork item 5297.02 (please order separately)

item	l x w x h in cm	content in l	PU
5296.02	4.9x4.9x11	0.1	12 pcs



17 cork
plastic, ecru, for glass bottle item 5296.02

item	Ø in mm	height in mm	PU
5297.02	26/15	28	24 pcs



2+18+24



18 glass bottle
clear glass, square, with swing top (plastic and stainless steel), height incl. swing top, **only for cruet stand item 2056 (page 268)!**

item	l x w x h in cm	content in l	PU
5295.01	5.4x5.4x12.5	0.1	12 pcs



19 glass bottle/creamer
clear glass, square, with glass stopper (round), with notched stopper for pouring with closed lid, height incl. stopper

item	l x w x h in cm	content in l	PU
5740	5x5x12.5	0.12	3 pcs



7+16+17+20



20 small glass bowl
clear glass, square, delivery without lid item 5254.01 (please order separately)

item	l x w x h in cm	content in l	PU
5254	4.9x4.9x4.5	0.05	4 pcs



21 small glass creamer
clear glass, square, delivery without lid item 5254.01 (please order separately)

item	l x w x h in cm	content in l	PU
5255	4.9x4.9x4.5	0.05	4 pcs



22 glass miniature
clear glass, lid for small glass bowl item 5254 and glass creamer item 5255

item	l x w in cm	PU
5254.01	4.9x4.9	12 pcs



23 small bowl
china, square, 4.9 cm long, 4.9 cm wide, 7 cm high, 0.11 l content

item	colour	PU
3855	white	4 pcs
3855.01	black, matt	4 pcs



24 small bowl
china, square, 4.9 cm long, 4.9 cm wide, 4.5 cm high, 0.05 l content

item	colour	PU
3845	white	4 pcs
3845.01	black, matt	4 pcs



25 small creamer
china, white, square

item	l x w x h in cm	content in l	PU
3849	4.9x4.9x4.5	0.05	4 pcs

... for every purpose!



4+14+15

3+29

inserts up to 7 cm x 7 cm

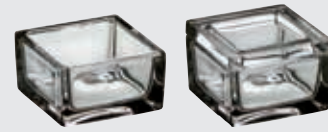

26 small glass bowl
clear glass, square, delivery without lid item 5338.01 (please order separately)

item	l x w x h in cm	content in l	PU
5338	7x7x3.9	0.1	12 pcs



27 glass miniature
clear glass, square, lid for small glass bowl item 5338

item	l x w in cm	PU
5338.01	7x7	12 pcs

6+28+29



28 glass bottle
clear glass, square, with swing top (plastic and stainless steel), height incl. swing top

item	l x w x h in cm	content in l	PU
5295.02	6.7x6.7x14.5	0.2	12 pcs

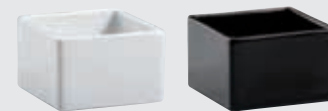

29 small bowl
china, square, 7 cm long, 7 cm wide, 4.5 cm high, 0.13 l content

item	colour	PU
3854	white	4 pcs
3854.01	black, matt	4 pcs



30 small bowl
china, white, square

item	l x w x h in cm	content in l	PU
3853	7x7x2	0.05	12 pcs



"Ménage-à-trois"
stainless steel 18/10, for 3 bowls (Ø inside: 8.4 cm each)

item	Ø in cm	height in cm
2058	16.5	18

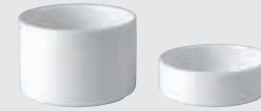

small bowl "Catering"
china, white

item	Ø / height in cm	content in l	PU
4499	8 / 5.5	0.2	6 pcs
4500	8 / 2.5	0.08	12 pcs



small bowl
china, white

item	Ø / height in cm	content in l	PU
4498	8 / 6	0.17	6 pcs



glass tumbler
borosilicate glass, transparent, handblown, double-walled

item	Ø / height in cm	content in l	PU
4907	8 / 10	approx. 0.28	6 pcs



glass miniature
clear glass

item	Ø / height in cm	content in l	PU
5420	8 / 5	0.13	6 pcs



glass miniature
clear glass, satined

item	Ø / height in cm	content in l	PU
5420.01	8 / 5	0.13	6 pcs



small glass bowl "Halfmoon"
borosilicate glass, transparent, handblown, double-walled

item	Ø / height in cm	content in l	PU
4954.02	8 / 9	approx. 0.17	6 pcs

"Ménage-à-trois"



The vinegar/oil bottles are available on pages 266 and 267.



Trays made of melamine ...

More items made of melamine and numerous variations are available on pages 120-126.



tray
melamine, black, surface matt, food-safe, dishwasher-safe, not suitable for microwave and combi steam oven

item	l x w x h in cm	PU
4586	25.2x13.2x1.8	2 pcs



GN tray
melamine, black, surface matt, food-safe, dishwasher-safe, not suitable for microwave and combi steam oven

item	l x w x h in cm	GN	PU
4587	32.5x17.6x1.8	1/3	2 pcs
4588	32.5x26.5x1.8	1/2	2 pcs
4589	53x32.5x1.8	1/1	2 pcs



The glass bowl item 5444 is available on page 275.



tray
melamine, black, surface matt, food-safe, dishwasher-safe, not suitable for microwave and combi steam oven, with 3 oval sockets (diagonal), for small bowls items 4081.12 (china) and 5444 (glass)

item	l x w x h in cm	PU
4593	32.5x13.2x1.8	2 pcs

Suitable for items with a bottom diameter of less than 5.5 cm or 8.2 cm



2/8 GN tray
melamine, black, surface matt, food-safe, dishwasher-safe, not suitable for microwave and combi steam oven, with 3 round sockets (Ø 5.5 cm / 8.2 cm)

item	l x w x h in cm	PU
4590	32.5x13.2x1.8	2 pcs



spoon rest "Modul"
melamine, black, surface matt, food-safe, dishwasher-safe, not suitable for microwave and combi steam oven, with 4 rubber feet (black)

item	l x w x h in cm	PU
4585	20x5x4	2 pcs

The china bowl "Duo" is available on page 277.

... with suitable inserts

Suitable inserts and boxes made of melamine are available on pages 122 to 126.



The trays made of melamine in well-established GN-size can be equipped with many items. A wide range of different miniatures is available on pages 203 to 239.



... for item 4590

creamer
china, white, stackable

item	Ø / height in cm	content in l	PU
4489	5.3 / 9	0.13	6 pcs

miniature
china, stackable, Ø 5.3 cm, 7 cm high, 0.1 l content

item	colour	PU
4490	white	6 pcs
4490.01	black	6 pcs

glass miniature
borosilicate glass, transparent, handblown, double-walled

item	Ø / height in cm	content in l	PU
4903	5.5 / 8.5	approx. 0.1	6 pcs



glass
clear glass

Art.-Nr.	Ø / Höhe in cm	Inhalt in l	VPE
5380	7.5 / 10.5	0.32	6er Pack
5381	7.5 / 6	0.18	6er Pack

glass bottle
clear glass, with swing top (PVC lid), height incl. swing top

item	Ø / height in cm	content in l	PU
5290.02	5.5 / 19	0.2	12 pcs

small bowl "Catering"
china, white

item	Ø / height in cm	content in l	PU
4499	8 / 5.5	0.2	6 pcs
4500	8 / 2.5	0.08	12 pcs

small bowl
china, white

item	Ø / height in cm	content in l	PU
4498	8 / 6	0.17	6 pcs

glass miniature
clear glass

item	Ø / height in cm	content in l	PU
5420	8 / 5	0.13	6 pcs

glass miniature
clear glass, satined

item	Ø / height in cm	content in l	PU
5420.01	8 / 5	0.13	6 pcs

small glass bowl "Halfmoon"
borosilicate glass, transparent, handblown, double-walled

item	Ø / height in cm	content in l	PU
4954.02	8 / 9	approx. 0.17	6 pcs

glass tumbler
borosilicate glass, transparent, handblown, double-walled

item	Ø / height in cm	content in l	PU
4907	8 / 10	approx. 0.28	6 pcs

... for item 4593



glass bowl
clear glass, oval

item	l x w x h in cm	content in l	PU
5444	12.5x7x4	0.08	6 pcs

bowl
china, white, oval

item	l x w x h in cm	content in l	PU
4081.12	12.5x7.5x4	0.1	12 pcs

Trays made of glass ...



glass tray

glass, deep black, rectangular, for buffet or flying buffet or functions as a tray

item	l x w x h in cm
5141.26	26x14x2
5141.34	34x18x2
5141.50	51x35x2



glass tray

glass, deep black, square, for buffet or flying buffet, functions as a tray or as a dinner plate

item	l x w x h in cm
5142.34	35x35x2



glass tray

glass, deep black, with 3 oval sockets (diagonal, 4.7 cm x 8.5 cm at bottom area), for bowl items 4081.12 (china) and 5444 (glass)

item	l x w in cm
5143	32x14



glass tray

glass, deep black, with 3 round sockets (Ø 6 cm at bottom area)

item	l x w in cm
5145	32x12



The cocktail glass is available on page 218.

5145 + 4962

... for item 5143



bowl

china, white, oval

item	l x w x h in cm	content in l	PU
4081.12	12.5x7.5x4	0.1	12 pcs



glass bowl

clear glass, oval

item	l x w x h in cm	content in l	PU
5444	12.5x7x4	0.08	6 pcs

... for item 5145



small bowl

china, white, deep, oval

item	l x w x h in cm	content in l	PU
4326.11	11x9x3.8	0.1	12 pcs

small glass bowl

clear glass, deep, oval

item	l x w x h in cm	content in l	PU
5442	11x9x3.8	0.09	6 pcs



bowl "Duo"

china, white

item	l x w x h in cm	content in l	PU
4231.50	13x7x3.5	0.08	12 pcs



glass tray with bowls

set consists of:
glass tray, deep black
3 china bowls "Duo", white, 0.08 l content each,
 1 set in black gift box

item	l x w in cm	PU
5135.PB	32x12	1 set (4 parts)

More sizes are available on page 219.



small glass bowl "Halfmoon"

borosilicate glass, transparent, handblown, double-walled

item	Ø / height in cm	content in l	PU
4954.01	6 / 7.5	approx. 0.08	6 pcs

... with suitable inserts!



glass

clear glass

item	Ø / height in cm	content in l	PU
5380	7.5 / 10.5	0.32	6 pcs
5381	7.5 / 6	0.18	6 pcs



small glass bowl "Spobo" with spoon rest

clear glass, for spoons with a total length of 12 cm and over

item	Ø / height in cm	content in l	PU
5440	10 / 4	0.08	6 pcs

glass bowl "Duo"

clear glass

item	l x w x h in cm	content in l	PU
5441	11.5x7x3.5	0.07	6 pcs

"Fakir"



bowl/display "Fakir"
brass, inside golden (transparent coating, food-safe), outside dark patinated, not dishwasher-safe

item	Ø in cm	height in cm
2380.07	7.5	11
2380.12	12.5	10
2380.15	15	8.5
2380.18	18	9.5



coaster/glass insert
hardened clear glass, 4 mm thick, round, edge polished and deburred, with 4 transparent silicone feet

item	Ø in cm	PU
5244.09	9	6 pcs
5244.11	11	6 pcs
5244	13	6 pcs
5244.17	16.7	1 pc.
5244.21	20.7	1 pc.
5244.24	24.2	1 pc.
5244.28	28.2	1 pc.

Massive brass produced in traditional sand casting creates unique sculptural items, which enthrall especially by their contrast between matt golden surfaces and dark patination. An interesting add-on to the "Fakir" bowls are round glass platters of the Zieher product range. These can be laid on easily and generate thus the option to use the impressive objects on both sides.

Please note: The items made of brass are suitable for cold/dry food only. Not dishwasher-safe.



ashtray for cigars
optical glass, transparent, also usable as a rest for tongs or spoons, in black gift box

item	l x w x h in cm
5210	15x9x3



Candle holders Wind lights





For tealights or candles up to a height of 10 cm and a diameter of 7 cm.

"Somnia"

At first glance the golden branches, strapped to a bundle, are reminiscent of a besom of a different kind. With candlelight this extraordinary lighting object creates fascinating effects and provides for a cosy and comfortable ambience.

The filigree rods, visually appealing like thin branches, are made of brass and manufactured piece by piece in traditional sand casting. Afterwards they are soldered onto a solid baseplate with an elevated rim. This baseplate avoids the leakage of wax and protects the table surface from the heat. Additionally it forms the frame for a removable cylinder, made of heat resistant glass, which by way of its satined surface intensifies the mood of the light and protects the flame from wind at the same time.



candle holder/wind light "Somnia"

brass, golden, matt, not dishwasher-safe, for glass insert item 4991.02 (please order separately) and candles up to Ø 7 cm

item	Ø foot in cm	Ø top in cm	height in cm
2383.01	11	approx. 16.5	approx. 19.5



wind light

borosilicate glass, satined inside, open at the top and at the bottom, for candle holder/wind light "Somnia" item 2383.01

item	Ø in cm	height in cm	PU
4991.02	9	14.5	6 pcs



candle holder/wind light "Somnia"

set consists of:

candle holder/wind light "Somnia" made of brass, golden, not dishwasher-safe, for candles up to Ø 7 cm
glass insert made of borosilicate glass, satined inside, open at the top and at the bottom,
 1 set in black gift box

item	Ø foot / top in cm	height in cm	PU
2384.PB	11 / approx. 16.5	approx. 19.5	1 set (2 parts) 📦



candlestick "Stele"

brass, hammered, polished, for straight and tapered candles

item	Ø in cm (foot)	height in cm
2440.25	7	approx. 25.5
2440.32	8.5	approx. 32
2440.46	11	approx. 46.5

candlestick "Stele"

in black gift box

item	Ø in cm (foot)	height in cm
2440.25PB	7	approx. 25.5
2440.32PB	8.5	approx. 32
2440.46PB	11	approx. 46.5



candlestick "Stele"

brass, hammered, matt black (powder-coated), for straight and tapered candles

item	Ø in cm (foot)	height in cm
2441.25	7	approx. 25.5
2441.32	8.5	approx. 32
2441.46	11	approx. 46.5

candlestick "Stele"

in black gift box

item	Ø in cm (foot)	height in cm
2441.25PB	7	approx. 25.5
2441.32PB	8.5	approx. 32
2441.46PB	11	approx. 46.5

Stelae of light!

Like the archaic columns of historical buildings, these candlesticks stand tall and proud. The irregular surface is appealing and pleasing to the eye of the beholder as well as being testament to the genuine handicraft put into the creation of these pieces of art.

The candlesticks consist of solid brass and are available in three sizes and two different surface finishes, which give opposite impressions. The high gloss polished version generates beautiful, golden reflexes, the matt black variant is characterised by its elegance and unobtrusiveness. Whether only one version is used or both versions in combination, a lot of appeal can be found both ways. The holders are suitable for commercial straight and tapered candles. The undersides are covered with black felt to protect delicate furniture.



Wind lights



Please note: The wind lights made of glass items 4987.01 and 4987.02 can get very hot if wax candles are used for longer burning times. We recommend to use our LED tealights (page 284).



Suitable bread bowls "Solid" are available on page 251.



The stepped drillings in our wind lamps made of walnut allow the usage of Zieher LED tealights (page 284) as well as standard tealights with a diameter of 38 mm and 58 mm.



wind light

borosilicate glass, transparent, with 3 notches at the bottom, open at the top, handmade

item	Ø in cm	height in cm
4987.01	9	approx. 12 - 13



wind light

borosilicate glass, satined (inside), with 3 notches at the bottom, open at the top, handmade

item	Ø in cm	height in cm
4987.02	9	approx. 12 - 13



coaster "Solid"

walnut, food-safe sealed, not dishwasher-safe, for glass insert item 5244.09

item	Ø / height in cm	Ø inner circle in cm
4700.01	15.3 / 2	9.3



wind light

borosilicate glass, satined inside, open at the top and at the bottom, for tealight holder "Solid" item 4716

item	Ø in cm	height in cm	PU
4991.02	9	14.5	6 pcs



tealight holder "Solid"

walnut, food-safe sealed, not dishwasher-safe, oblique, with stepped hole for small (Ø 4 cm) and large (Ø 6 cm) tealights and for glass wind light item 4991.02

item	Ø in cm	Ø inside in cm	height in cm
4716	13	9.4	10.5



For tealights or candles up to a height of 10 cm and a diameter of 7 cm.



candle holder/wind light "Reef"

pewter, surface smooth, food-safe, not dishwasher-safe, with feet, for glass insert item 4991.02 and candles up to Ø 7 cm

item	Ø in cm	height in cm
2315.01	10	15.5



wind light

borosilicate glass, satined inside, open at the top and at the bottom, for candle holder/wind light "Reef" item 2315.01

item	Ø in cm	height in cm	PU
4991.02	9	14.5	6 pcs



candle holder/wind light "Reef"

Set consists of:

candle holder/wind light "Reef" made of pewter, surface smooth, food-safe, not dishwasher-safe, with feet, for candles up to Ø 7 cm,

glass insert made of borosilicate glass, satined inside, open at the top and at the bottom, 1 set in black gift box

item	Ø in cm	height in cm	PU
2316.PB	10	16.5	1 set (2 parts)

"Reef"



The wind light fascinates by reflections of the candlelight in the silvery metal and the dancing shadows of the slender structures. A removable cylinder made of heat resistant glass protects the flame from wind and thus allows the usage in the garden and on the terrace.



Since medieval times, pewter has been used primarily for table top items and has been the most important raw material for them for a very long time. The popularity of pewter first started decreasing in the 18th and 19th century by the progressing development of glass and the increasing popularisation of porcelain. Since then the usage of pewter has shifted mainly to decorative elements. Up-to-date pewter is 100 % lead-free and therefore uncritical when used for food.



wind light

biscuit china, white, translucent, with a round, oblique opening, for coaster item 4398

item	Ø in cm	height in cm	PU
4397	11	13.5	6 pcs



coaster

biscuit china, white, inner circle glazed (Ø 9.5 cm), for round items with an inner diameter of 10.5 cm

item	Ø in cm	height in cm	PU
4398	11.5	1.3	6 pcs

wind light with coaster

set consists of:

wind light made of biscuit china, white, translucent, with a round, oblique opening

coaster made of biscuit china, white, inner circle glazed (Ø 9.5 cm), 1 set in black gift box

item	Ø in cm	height in cm	PU
4399.PB	11.5	14.8	1 set (2 parts) 📦



a) LED-tealight set

plastic, set consists of one induction charging station black and 12 white LED-tealights (Ø 4 cm, 5 cm high, yellow light, flickering effect), delivery without power supply items 8132... (please order separately)

item	l x w x h in cm
8130	30.5x13.5x4

LED-tealight

plastic, white, yellow light, flickering effect, for LED-tealight set item 8130

item	Ø in cm	height in cm	PU
8131	4	5	4 pcs

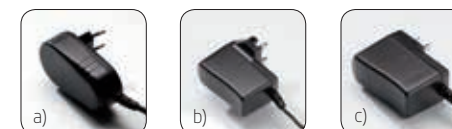

power supply

for LED-tealight set item 8130, up to 4 LED-tealight sets (total of 48 candles) can be connected using 1 power supply only

item	version
a) 8132.EU	Europe
b) 8132.UK	UK
c) 8132.US	USA

Consistently long lighting time with deceptively real flickering effect!

The LED-candles, in combination with different fitting Zieher tealight holders, turn every table into a homelike place for romantic hours. The power supplies, which are available separately, optionally with EU-, UK- or US-plug, guarantee a worldwide operation of the LED set. Due to the induction charging mechanism, the LED-candles do not have any electrical contacts. This feature as well as their water resistance (not waterproof) make them ideal for outdoor use. Each tealight candle is equipped with a yellow shining LED and by skilfully switching between bright and dark, it achieves a deceptively real candle flickering effect. The rechargeable battery, which is integrated in the LED-candle, assures a lighting time of 20 hours with a charging time of about 8 - 9 hours and a lifetime of more than 500 charging cycles (this equates about 10.000 operating hours). The induction charging base, which is included in the set (item 8130), allows the charging of up to 12 LED-candles at the same time. Another plus is the integrated plug connection which allows to connect up to 4 charging bases to one single power supply. This enables the charging of up to 48 LED-candles with one electrical socket at the same time. One set (item 8130) includes 12 LED-candles and 1 induction charging base. The respective power supply (item 8132.EU/UK/US) needs to be ordered separately.

Bring the romantic atmosphere of candles to your own table - via modern LED technology!



Room service Guestrooms

"Solid"



More items of the series "Solid" for the buffet are available on pages 102 to 117.



glass platter 2/1 GN
hardened glass, 10 mm thick, dark grey, rectangular, edges polished and deburred

item	l x w in cm
8004.07B	65x53

The tray stand of the series "Solid" convinces in every aspect!

The shapely stand always provides the appropriate possibility to set up the "Solid" room service tray (item 4735) in the hotel room but also in the restaurant. Combined with Zieher buffet platters in the format 2/1 GN, the stand easily and flexibly creates new spaces at a comfortable height. It is predestined for the use at the buffet as well as for the use during coffee breaks in the congress and convention business. The massive frame made of walnut wood harmonizes perfectly with other buffet items of the series (pages 102 to 117) and can be combined with them very well. Anti-slip rubber feet on the top prevent the shifting of platters and trays, felt gliders at the base protect the parquet flooring and ensure safe standing.

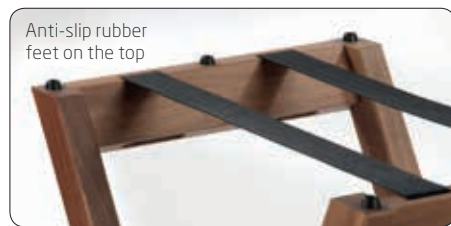

tray stand/side table "Solid"
walnut, with black nylon ribbons, anti-slip rubber feet on top and felt gliders at the bottom, for trays and buffet platters in sizes starting from 55 cm x 36 cm, 102 cm high (folded up), 87 cm high (opened)

item	l x w x h in cm (opened)
4748	54.5x36x87



bed tray „Solid“
walnut, food-safe sealed, not dishwasher-safe, stackable, with feet, 2 handles, recessed on one side of the rim, in black gift box

item	l x w x h in cm (closed)	l x w x h in cm (set up)
4773.PB	60x40x6.5	approx. 74x40x31



The rubber feet at the base are set back from the rim to enable the transport on a tray trolley in 1/1 EN-format (60 cm x 40 cm).



roomservice tray "Solid"
walnut, food-safe sealed, not dishwasher-safe, stackable, recessed on one side of the rim, with 2 handles, with 4 rubber feet, suitable for tray stand "Solid" item 4748

item	l x w x h in cm
4735	60x40x5.4

Breakfast in bed - Inroom dining!



The roomservice tray as well as the "Solid" bed tray stand out due to the precious walnut which is incorporated into these products with high-quality craftsmanship. The recessed longside enables comfortable dining directly off the tray. The retractable feet of the bed tray have been constructed in a very stable way and are securely kept in position by integrated magnets when folded in. The height of the erected tray has been chosen in a way that even with soft mattresses a comfortable seating beneath the tray is guaranteed. So start off the day with a boundlessly relaxing breakfast in bed!



The recessed longside of the roomservice tray simplifies comfortable dining directly off the tray.

"Slope"

Design: Wilma Greim



4596.45

The melamine tray "Slope" is characterised by its unobtrusive shaping and the pleasant feel of the matt and finely structured surface. An elevated corner and the resultant asymmetry award the tray that certain something. Besides the obvious function as a service tray for espresso, cocktails, snacks and more it also performs well in the hotel bathroom or as a decorative trivet in the hotel room. An additional tray, which can also be used as a lid for the Zieher "Bento Box", is available on page 120.



The tray 4579 and the suitable "Bento Box" are available on pages 120/121.



4596.30



tray "Slope"

melamine, matt, rectangular (oblique), stackable, utility space: approx. 26 cm x 15.5 cm

item	colour	l x w x h in cm	PU
4595.30	black	30x19.5x4.2	3 pcs
4596.30	white	30x19.5x4.2	3 pcs



tray "Slope"

melamine, matt, rectangular (oblique), stackable, utility space: approx. 40 cm x 24 cm

item	colour	l x w x h in cm	PU
4595.45	black	45x29x4.2	2 pcs
4596.45	white	45x29x4.2	2 pcs

tray "Slope"

in black gift box

item	colour	l x w x h in cm	PU
4595.45PB	black	45x29x4.2	1 pc.
4596.45PB	white	45x29x4.2	1 pc.

4595.30



"Solid"

This service tray with integrated separations is perfectly suitable for the service of small dishes at the pool, the beach or in the room.



serving tray "Solid"

walnut, food-safe sealed, not dishwasher-safe, stackable, 2 compartments: 30 cm x 30 cm and 30 cm x 8 cm (for cutlery or china/glass bowls), with 4 rubber feet

item	l x w x h in cm
4769	41.7x32.5x6.7

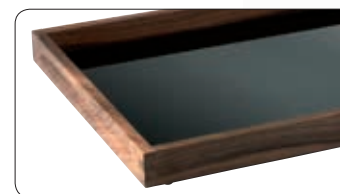

serving tray "Solid"

walnut, flat, food-safe sealed, not dishwasher-safe, with 2 recessed grips, with 4 rubber feet, in black gift box

item	l x w x h in cm	l x w (inside) in cm
4707.PB	53x37x4	50.2x34.2



buffet platter

special hardened safety glass, 4 mm thick, rectangular, rounded edges, polished rim, dishwasher-safe, rubber feet included (adhesive), underside scratch-proof, for serving tray "Solid" items 4707.PB and 4740

item	version	l x w in cm
1668.03	black glass	50x34
1670.03	white glass	50x34



The major compartment has been designed for plates with a max. diameter of up to 29 cm, the lateral separation offers sufficient space for cutlery and napkin. Also insertion bowls with a max. width of 7.5 cm find space and thus can be used for dips, salad and other side dishes. You will find a selection of suitable inserts on page 272.

The trays are equipped with integrated grip holes respectively recessed grips and they are stackable. Finger joints at the corners, non-skid rubber feet and a food-safe sealing of the solid walnut wood fulfill the high quality standards which are valid for all items of the "Solid" range.

The plates and cloches of the "Cuspis" series are available on pages 142 and 143.



"Solid"



Hoteltosmetic: PAM Berlin Slipper & Hotel Supplies - www.pam-berlin.de



1 storage/presentation box "Solid"
walnut, food-safe sealed, not dishwasher-safe, with sliding lid made of wood, also available with glass lid item 4762.18G (please order separately)

item	l x w x h in cm	size inside in cm
4762.18	18x18x6	approx. 16x16x4.2



serving tray "Solid"
walnut, food-safe sealed, not dishwasher-safe, with 4 rubber feet

item	l x w x h in cm	l x w in cm (inside)
4713	34x34x3	32x32



cutlery/napkin box "Solid"
walnut, food-safe sealed, not dishwasher-safe, with rubber feet in the lid (soft closure, can be opened to an angle of 90° only) and at the bottom, with black felt insert, stainless steel platter with space for an engraving (price and quantity upon request), 15.5 cm height with open lid

item	l x w x h in cm	size inside in cm
4766	28.8x11.8x6	26x8.7



"Solid"



2 glass lid
hardened glass, brown tinted, with recess, for storage/presentation box "Solid" item 4762.18

item	l x w in cm
4762.18G	17.3x16.7

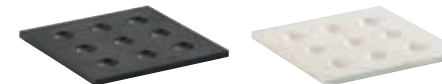

3 insert for chocolates
solid surface material, with 9 cavities (Ø 2.2 cm), for storage/presentation box "Solid" item 4762.18

item	colour	l x w x h in cm
4763.01S	black	15.8x15.8x1
4763.01W	white	15.8x15.8x1

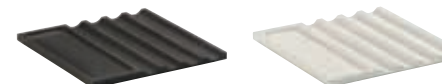

4 insert for cigars
solid surface material, for 4 cigars (grooves 1.9 cm wide), storage area for accessories (14.8 cm x 4.8 cm), for storage/presentation box "Solid" item 4762.18

item	colour	l x w x h in cm
4763.02S	black	15.8x15.8x1
4763.02W	white	15.8x15.8x1

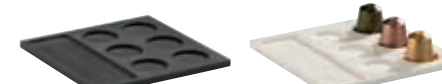

5 insert for coffee capsules
solid surface material, with 6 cavities (Ø 3.8 cm), storage area for accessories (14.8 cm x 4.8 cm), for storage/presentation box "Solid" item 4762.18

item	colour	l x w x h in cm
4763.03S	black	15.8x15.8x1
4763.03W	white	15.8x15.8x1



6 insert/platter
solid surface material, white, usable area: 14.8 cm x 14.8 cm, for storage/presentation box "Solid" item 4762.18

item	l x w x h in cm
4763.04W	15.8x15.8x1



Delicacies in delicate setting!

Due to the comprehensive range of accessories the "Solid" presentation box offers multiple application possibilities. The box, regularly fitted with a wooden sliding lid, can be equipped with several optionally available inserts made of top-quality solid surface material. The also available lid made of brown-tinted glass puts the presented goods in the limelight.

Apart from an insert with round cavities for nine truffles/chocolates and a flat plate that can be used for layered chocolates, various little somethings or amuse bouches, there is also an insert available for commercial coffee capsules. The insert for cigars can hold up to four cigars and a separate compartment aside offers additional space for matches, cigar cutters, etc. No matter if it is an assortment of coffee specialities or various delicacies of the pâtisserie, the presentation box by Zieher provides the perfect setting for many purposes.



"Donna"

Extraordinary storage places ...
... for extravagant guestrooms!



Bedded on glass

This variant of the "Donna" pillow is made of frosted glass and despite its hard and massive raw material it surprises by its pleasantly soft and velvety feel.

The organic shape of this extraordinary piece offers an ideal presentation area for extravagantly staged intermediate courses or serves as a fancy place to keep all sorts of small objects of everyday life. Even when used as a soap dish, the pillow cuts a good figure. A version made of porcelain is available on page 144.



The porcelain pillow "Donna" is available on page 144.



glass pillow "Donna"
glass, satined, in black gift box

item	l x w x h in cm
5446.01PB	16.5x11x3



wooden pillow "Donna"
solid walnut, oiled, not dishwasher-safe, 4 rubber feet, in black gift box

item	l x w x h in cm
4772.33PB	33.5x22.5x7

Bedded on wood

Made of solid wood, milled with dedication and refined with high quality oils!

This sculpture of solid walnut, one of the finest European varieties of wood, has its own appearance. The sealing with oils emphasises the striking grain of the wood and gives the surface a silk-matt gloss as well as amazing haptics.

One just has to touch the softly curved forms of this hand charmer. Whether used as a fruit bowl, as a place to keep accessories or as sculptural decoration - "Donna" seduces in every material!



The platter "Collina" is available on page 151.



Etagere "DressCoat"

massive stainless steel 18/10, hammered, polished, 3-armed

item	Ø in cm	height in cm
2212.30	36	30

Please note: We recommend the use of large plates on the lower level only.



glass plate "Unique"

glass, white marbled, bottom satined, round

item	Ø in cm	PU
5178.21	21	6 pcs
5178.28	28	6 pcs



glass plate "Unique"

glass, black marbled, bottom satined, round

item	Ø in cm	PU
5179.21	21	6 pcs
5179.28	28	6 pcs

Etagere "DressCoat"



The etagere with three tiers, made of hammered and highly polished stainless steel, forms an extravagant basis for many sorts of plates and platters. Even in the hotel room the etageres can be positioned in an eye-catching way. Equipped with "DressCoat" (item 4388, page 77) or other tableware, small snacks, a selection of fruit or a sweet welcoming treat can be staged in an appealing way. All information about this etagere is available on page 77.

You can find the plateau plate item 4388 and further items of the "DressCoat" series on page 148.



"Capiz"



Hotelcosmetic: PAM Berlin Slipper & Hotel Supplies www.pam-berlin.de

Genuine clamshells are grinded razor-thin and embedded in robust resin. This process protects and stabilizes the delicate clamshell-wafers in the long term. The transparent resin creates an impressive depth effect and classy shine on every item of the "Capiz" series.

The champagne bowls of the "Capiz" series are available on page 65.



tray "Capiz"

shell, ivory-coloured, square, resin-coated, not dishwasher-safe

item	l x w x h in cm
7103.20	20x20x2
7103.26	26x26x2



bowl "Capiz"

shell, ivory-coloured, oval, resin-coated, not dishwasher-safe

item	l x w x h in cm
7106.46	46.5x24x13.5



More items of the series "Capiz" are available on page 168.

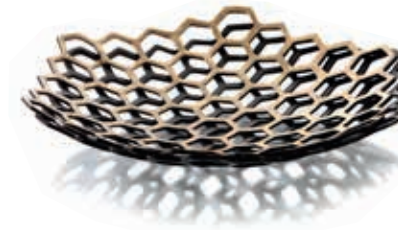

bowl "Matrix"

brass, top golden (transparent coating, food-safe), bottom dark patinated, hexagonal, flat, not dishwasher-safe

item	Ø in cm	height in cm
2382.38	38	7



bowl "Roots"

brass, golden (transparent coating, food-safe), round, not dishwasher-safe

item	Ø in cm	height in cm
2381.38	38	8

bowl "Roots"

in black gift box

item	Ø in cm	height in cm
2381.38PB	38	8



More information about the "Fakir" displays and suitable cover plates made of glass are available on pages 66 and 67.

"Reef"



bowl/basket "Reef"
pewter, smooth outside, round, food-safe, not dishwasher-safe, with supporting feet, for small glass bowl item 5166 (please order separately)

item	Ø in cm	height in cm
2310	13	8



glass bowl
glass, 6 mm thick, dark grey, organically shaped, for bowl/basket "Reef" item 2310 (please order separately)

item	Ø / height in cm	content in l	PU
5166	13 / 6.5	approx. 0.3	2 pcs



bowl/basket "Reef"
pewter, smooth outside, round, flat, food-safe, not dishwasher-safe

item	Ø in cm	height in cm
2311	22	5



bowl/basket "Reef"
pewter, surface smooth, food-safe, not dishwasher-safe, with feet

item	l x w x h in cm
2314.01	approx. 15x9x24
2314.02	approx. 21x12.5x33
2314.03	approx. 37x18.5x52

bowl/basket "Reef"
in black gift box

item	l x w x h in cm	PU
2314.01PB	approx. 15x9x24	1
2314.02PB	approx. 21x12.5x33	1
2314.03PB	approx. 37x18.5x52	1



bowl/basket "Reef"
pewter, smooth outside, oval, food-safe, not dishwasher-safe

item	l x w x h in cm
2313.01	46x19x20
2313.02	32x13x13



The bowls and baskets of the "Reef" series are veritable eye-catchers due to their organic structure and exceptional shapes. An assortment of bread and fruit in the hotel room or on the buffet table is put perfectly into the limelight by the transparency of the "Reef" items; carefully draped towels are also exquisitely presented in the bathroom or in the spa area.



More items and information about the "Reef" series are available on pages 62 to 64.

"Podia"



buffet bridge "Podia", triple pack
genuine wood veneer, light colouring (similar to oak), not dishwasher-safe

item	w x d x h in cm	PU
8731	30x20x6 (1st bridge)	1 set
	36x20x9 (2nd bridge)	
	42.5x20x12 (3rd bridge)	



The fruit bowl "Sixth Sense" item 2171.02 is available on page 78.

Please note: by reason of manufacturing, deviations from the declared measurements of the bridges may occur!

In-Room Dining

The buffet bridges and trays of the "Podia" series offer several advantages! They are light but robust, flexibly usable and can be stored in a space-saving way. With its use as a display on the buffet, during coffee break or as a platter for fruit or little somethings in the hotel room - "Podia" offers multiple possibilities for use and flexible handling. The tray in 1/2 GN format is especially suitable for different miniatures made of porcelain and glass. Slide-proof silicone coasters in different styles (page 210) guarantee a good grip during service. All parts of this series consist of form-glued authentic wood veneer. The bridges are available in two types of wood. The light version harmonizes very well with mundane but also with rustic-style furnishing, the version with the black-brown stripes appears exotic and modern.



buffet bridge "Podia", triple pack
genuine wood veneer, dark (black-brown striped), not dishwasher-safe

item	w x d x h in cm	PU
8730	30x20x6 (1st bridge)	1 set
	36x20x9 (2nd bridge)	
	42.5x20x12 (3rd bridge)	



GN tray "Podia"
genuine wood veneer, dark (black-brown striped), not dishwasher-safe

item	l x w in cm	GN	PU
8732.03	32.5x26.5	1/2	6 pcs



Hotelcosmetic:
PAM Berlin Slipper & Hotel Supplies -
www.pam-berlin.de

Please note the care instructions: not dishwasher-safe, do not immerse in water!



Photo: Dötzer Restauration, Bayreuth, Germany, www.doetzers.de



coat rack "Kibu"

solid wood, dark stained, foot: stainless steel (brushed), adjustable base for firm positioning on most surfaces

item	Ø in cm	height in cm
7700	60	210

"From the merely comparable to the extraordinary" was the guiding principle during the development of the "Kibu" coat rack. The rack is made of massive European hardwood and has a dark brown hue. The bottom plate made of 8 mm strong, satined stainless steel creates a pleasing cool contrast to the warm aura of the solid wood and simultaneously provides a very safe and steady base. The 16 bolts, which can be used to hang many jackets and other pieces of clothing, are also made of stainless steel, relating to the material of the base. Rolling lines and surfaces unite harmoniously and fit unobtrusively to every style of furnishing. Offering a high degree of functional usefulness, combined with extraordinary design - "Kibu" is both an item of daily use and a design feature.

quick-finder - list of items in ascending order

item	description	page	item	description	page	item	description	page
0405.1288	miniature fork "Europa"	233	2138	chocolate/ice cube tongs	95, 249	2197	etagere	81
0405.1388	miniature fork "Europa"	233	2139	servicing tongs	95	2198	etagere	81
1501	cork	138, 224	2140	servicing tongs	95	2198.PB	etagere	81
1502	cork	266	2141.01	buffet stand	82	2199.30	bowl	81
1668.01	buffet platter, black glass	50, 246	2141.02	buffet stand	82	2199.40	bowl	81
1668.03	buffet platter, black glass	50, 108, 246, 289	2141.03	buffet stand	82	2199.50	bowl	81
1668.04	buffet platter, black glass	50	2153	small bowl	85, 235	2200.PB	illuminated champagne bowl	83
1668.05	buffet platter, black glass	50	2153.01	small bowl	85, 236	2201	etagere with 3 tiers (each 7 miniature plates)	87, 259
1668.06	buffet platter, black glass	50, 188	2154	spoon rest	95	2201.PB	etagere with 3 tiers (each 7 miniature plates)	87, 259
1668.08	buffet platter, black glass	50, 58, 91	2159.16	bowl	85, 236	2202	etagere with 1 tier (7 miniature plates)	86, 237, 259
1668.09	buffet platter, black glass	50	2159.16PB	bowl	85, 236	2202.PB	etagere with 1 tier (7 miniature plates)	86, 237, 259
1668.10	buffet platter, black glass	50, 170, 188	2159.20	bowl	85, 236	2203.08	miniature plate with rod	89, 238
1668.12	buffet platter, black glass	50, 90	2159.20PB	bowl	85, 236	2203.13	miniature plate with rod	89, 238
1668.14	buffet platter Curve 45°	50	2160.66	sushi tray	94	2203.18	miniature plate with rod	89, 238
1668.15	buffet platter Curve 90°	50	2163	champagne bowl	84	2203.23	miniature plate with rod	89, 238
1669.33	charger plate, black glass	50, 114, 185, 188, 250	2167.15	holder coil shape	88	2204.08	amuse gueule stand with foot	86, 237, 259
1669.53	buffet platter, black glass	50	2167.20	holder coil shape	88	2204.11	amuse gueule stand with foot	86, 237, 259
1670.01	buffet platter, white glass	51	2167.25	holder coil shape	88	2206.50	flat bowl	86
1670.03	buffet platter, white glass	51, 108, 246, 289	2167.30	holder coil shape	88	2206.50PB	bowl flat	86
1670.04	buffet platter, white glass	51	2169	bowl "Wings"	79	2206.60	flat bowl	86
1670.06	buffet platter, white glass	51, 188	2169.01	bowl "Wings"	79	2207.11	ice cream cup with foot	86, 237, 259
1670.08	buffet platter, white glass	51, 58, 91	2169.02	bowl "Wings"	79	2207.15	ice cream cup with foot	86, 237, 259
1670.09	buffet platter, white glass	51	2170	bowl/basin XXL	83	2212.30	etagere "DressCoat"	77, 257, 293
1670.10	buffet platter, white glass	51, 170, 188	2171	bowl "Sixth Sense"	78	2260.16	bowl "Shine"	61, 111
1670.12	buffet platter, white glass	51, 90	2171.01	bowl "Sixth Sense"	78	2260.20	bowl "Shine"	61, 111
1670.14	buffet platter Curve 45°	51	2171.02	bowl "Sixth Sense"	78	2260.24	bowl "Shine"	61, 111
1670.15	buffet platter Curve 90°	51	2171.03	bowl "Sixth Sense"	78	2261.16	bowl "Shine"	61
1671.33	charger plate	51, 65, 114, 185, 188, 250	2174	bowl	82	2261.16PB	bowl "Shine"	61
1671.53	buffet platter, white glass	51	2177.10	buffet stand "Skyline"	16	2261.20	bowl "Shine"	61
1938	party spoon	152, 136, 233	2177.22	buffet stand "Skyline"	16	2261.20PB	bowl "Shine"	61
1938.01	party spoon	136, 136, 233	2177.34	buffet stand "Skyline"	16	2261.24	bowl "Shine"	61
1939.02	skewer "Flame"	88, 233, 239	2177.58	buffet stand "Skyline"	16	2261.24PB	bowl "Shine"	61
1939.04	small skewer "Flame"	165, 233, 239	2178.23	fruit/bread basket "Skyline"	18	2262.16	bowl "Shine"	61
2056	cruet stand for inserts up to 5 cm x 5 cm	268	2179.10	fruit/bread basket "Skyline"	18	2262.20	bowl "Shine"	61
2056.01	cruet stand for inserts up to 7 cm x 7 cm	268	2179.22	fruit/bread basket "Skyline"	18	2262.24	bowl "Shine"	61
2056.02	cruet stand for inserts up to 4 cm x 4 cm	268	2179.34	fruit/bread basket "Skyline"	18	2310	bowl/basket "Reef"	64, 296
2057	tray	262, 268	2180.09	bowl	80, 159, 235	2311	bowl/basket "Reef"	64, 296
2058	"Ménage-à-trois"	273	2180.13	bowl	80, 159, 235	2312.01	bowl/basket "Reef"	63
2101.17	tray	93, 261	2180.22	bowl	80	2312.02	bowl/basket "Reef"	63
2103.03PB	etagere with plates	93, 261	2180.22PB	bowl	80	2313.01	bowl/basket "Reef"	63, 296
2105.03	etagere	93, 261	2180.30	bowl	80	2313.02	bowl/basket "Reef"	63, 296
2105.04	etagere	93, 261	2180.30PB	bowl	80	2314.01	bowl/basket "Reef"	63, 296
2106.04PB	etagere with miniature plates	92, 260	2180.40	bowl	80	2314.01PB	bowl/basket "Reef"	63, 296
2107.03	etagere	92, 260	2181.17	bowl	85	2314.02	bowl/basket "Reef"	63, 296
2107.04	etagere	92, 260	2181.21	bowl	85	2314.02PB	bowl/basket "Reef"	63, 296
2109	bowl "Loop"	79	2181.24	bowl	85	2314.03	bowl/basket "Reef"	63, 296
2109.PB	bowl "Loop"	79	2182.09	bowl	80, 159, 236	2314.03PB	bowl/basket "Reef"	63, 296
2110	etagere	94, 258	2182.13	bowl	80, 159, 236	2315.01	candle holder/wind light "Reef"	64, 283
2110.01	tray	94, 258	2182.22	bowl	80	2316.PB	candle holder/wind light "Reef"	64, 283
2115	tongs holder	95	2182.30	bowl	80	2317	napkin ring "Reef"	64, 160
2116.41	bowl	84	2183	bowl	80, 84	2317.PB	napkin ring "Reef"	64, 160
2116.71	bowl	84	2184	buffet bowl	82	2332	bowl/basket "Reef"	62
2117	buffet bowl	84	2186	tray	85	2334	bowl/basket "Reef"	62
2119	buffet etagere	90, 90	2187	etagere	80, 236, 256	2335	bowl/basket "Reef"	62
2119.01	tray	90, 90	2188.14	tray	182, 256	2336	bowl/basket "Reef"	62
2119.02	buffet etagere	90, 90	2188.18	tray	256	2336.PB	bowl/basket "Reef"	62
2121.22	bread/pastry bowl	85	2188.22	tray	256	2370.23	tray "Artisan"	75
2132	buffet bowl	82	2188.27	tray	256	2370.28	tray "Artisan"	75
2133.12	bread/pastry bowl	85, 235	2189	etagere/pastry stand	256	2370.33	tray "Artisan"	75
2133.19	bread/pastry bowl	85, 235	2189.PB	etagere/pastry stand	256	2370.39	tray "Artisan"	75
2136	pastry tray	94, 258	2190	toast rack	95, 258	2371.07	bowl "Artisan"	74, 235
			2191.03	tray	233, 262	2371.11	bowl "Artisan"	74, 235
			2191.04	tray	233, 262	2371.14	bowl "Artisan"	74
			2193	buffet etagere	91	2372	bread/pastry bowl "Artisan"	74
			2193.01	tray	91, 57	2373	bread/pastry bowl "Artisan"	74
			2193.02	buffet etagere	91	2374.24	tray "Artisan"	75
			2194.03	food display	263			
			2194.06	food display	263			

quick-finder - list of items in ascending order

item	description	page
2375.33	charger plate "Artisan"	74, 188
2376	etagere "Artisan"	75
2380.07	bowl/display "Fakir"	66, 278
2380.12	bowl/display "Fakir"	66, 278
2380.15	bowl/display "Fakir"	66, 278
2380.18	bowl/display "Fakir"	66, 278
2381.38	bowl "Roots"	66, 295
2381.38PB	bowl "Roots"	66, 295
2382.38	bowl "Matrix"	66, 295
2383.01	candle holder/wind light "Somnia"	8, 280
2384.PB	candle holder/wind light "Somnia"	280
2385.01	display for bowls "Somnia"	8
2385.02	display for bowls "Somnia"	8
2386.10	buffet display "Somnia"	8
2386.20	buffet display "Somnia"	8
2440.25	candlestick "Stele"	281
2440.25PB	candlestick "Stele"	281
2440.32	candlestick "Stele"	281
2440.32PB	candlestick "Stele"	281
2440.46	candlestick "Stele"	281
2440.46PB	candlestick "Stele"	281
2441.25	candlestick "Stele"	281
2441.25PB	candlestick "Stele"	281
2441.32	candlestick "Stele"	281
2441.32PB	candlestick "Stele"	281
2441.46	candlestick "Stele"	281
2441.46PB	candlestick "Stele"	281
2543.30	charger plate	45, 186
2544.30	charger plate	45, 186
2779	salt & pepper mill set	271
3461	card holder	96
3466.02	cruet stand	264
3467.02	tray for inserts up to 5 cm x 5 cm	269
3468.02	cruet stand	265, 266
3469.02	tray for inserts up to 7 cm x 7 cm	269
3844	small bowl	222, 271
3845	small bowl	138, 222, 271
3845.01	small bowl	222, 271
3849	small creamer	222, 271
3853	small bowl	138, 222, 272
3854	small bowl	222, 272
3854.01	small bowl	222, 272
3855	small bowl	222, 271
3855.01	small bowl	71, 208, 222
3857	plate	164, 181, 184, 232
3858	small bowl	154, 222
3859	small bowl	154, 222
3912	dip bowl for olive oil	138, 220
3939.30	coup platter "Catering"	164
3954.08	coup plate "Catering"	164, 232, 260
3954.15	coup plate "Catering"	164
3954.19	coup plate "Catering"	164
3954.21	coup plate "Catering"	164
3954.25	coup plate "Catering"	164
3954.28	coup plate "Catering"	164
3955.16	plate "Catering"	164
3955.20	plate "Catering"	164
3955.26	plate "Catering"	164
3955.30	plate "Catering"	164
3956.23	plate "Catering"	164
3958.0	coffee cup "Catering"	164
3958.U	saucer "Catering"	164
3960.0	soup cup "Catering"	164
3960.U	saucer "Catering"	164
3962.06	small bowl "Catering"	164, 232
3963.14	salad bowl "Catering"	164

item	description	page
3963.16	salad bowl "Catering"	164
3963.19	salad bowl "Catering"	164
3963.23	salad bowl "Catering"	164
3971.30	plate "Catering"	164
3971.30	plate "Catering"	164
3977	egg cup "Catering"	164, 232, 264
4032.G	test tube	138, 224
4072.M	miniature platter	138, 230
4076	table display	96
4081.12	bowl	126, 231, 275, 277
4082	small bowl	230
4093	small creamer	230
4230.14	fruit/dessert bowl "Spobo"	152
4230.14PB	fruit/dessert bowl "Spobo"	152
4230.18	soup bowl "Spobo"	152
4230.18PB	soup bowl "Spobo"	152
4231.50	bowl "Duo"	231
4260.01	amuse gueule/tapas spoon	233
4260.03	amuse-gueule/tapas spoon "Modul"	137, 161, 233
4280.22	plate "Catering de Luxe"	165
4280.30	plate "Catering de Luxe"	165
4281	bowl "Catering de Luxe"	111, 165
4281.01	bowl "Catering de Luxe"	165
4281.02	bowl "Catering de Luxe"	165
4281.03	bowl "Catering de Luxe"	165
4281.04	bowl "Catering de Luxe"	165
4324.11	miniature plate	180, 231, 260
4326.11	small bowl	180, 231, 277
4359	fondue set, 2 parts	165
4375.01PB	bowl "Cave"	166, 221
4380	plate "Modul"	136, 161, 220
4381	bowl "Modul"	136, 161, 220
4383	plate "Modul"	137, 161, 220
4384	bowl "Modul"	136, 161, 220
4385.22	plate "Modul"	136, 161
4385.27	plate "Modul"	136, 161
4386	plateau plate "DressCoat"	148
4386.01	plateau plate "DressCoat"	148, 230
4386.02	plateau plate "DressCoat"	148, 230
4386.PB	plateau plate "DressCoat"	148
4387	plateau plate "DressCoat"	148
4387.PB	plateau plate "DressCoat"	148
4388	plateau plate "DressCoat"	148
4388.PB	plateau plate "DressCoat"	148
4389.09	plateau plate/small bowl "Cuspis"	142, 178, 205
4389.11	plateau plate/small bowl "Cuspis"	142, 178, 205
4389.25PB	plateau plate/bowl "Cuspis"	142, 178
4397	wind light	182, 284
4398	coaster	182, 232, 284
4399.PB	wind light with coaster	284
4458	dressings/jam jar	96
4461.01	porcelain pillow "Donna"	142, 230
4461.01PB	porcelain pillow "Donna"	144, 230
4461.02	porcelain pillow "Donna"	142, 230
4461.02PB	porcelain pillow "Donna"	144, 230
4461.03	porcelain pillow "Donna"	142, 230
4489	creamer	164, 232, 264, 275
4490	miniature	88, 164, 208, 232, 264, 275
4490.01	miniature	88, 164, 208, 232, 264, 275
4491	charger plate "SelectionA."	158

item	description	page
4492	charger plate "SelectionA."	158
4493.19	plate "SelectionA."	158
4493.24	plate "SelectionA."	158, 182
4495	plate "SelectionA."	158
4498	small bowl	232, 265, 273, 275
4499	small bowl "Catering"	164, 232, 265, 273, 275
4500	small bowl "Catering"	164, 232, 273, 275
4501	platter "Collina"	151
4501.PB	platter "Collina"	151
4502	platter "Collina"	151
4503	platter "Collina"	151
4504	platter "Collina"	151
4504.PB	platter "Collina"	151
4505	plate "Velo"	155
4505.01	plate "Velo"	155
4506	plate "Dots"	154
4507.01PB	plate/platter	140
4507.02PB	plate/platter	140
4563	china ball "oro79"	162
4564.12	plate "oro79"	162
4564.19	plate "oro79"	162
4564.26	plate "oro79"	162
4565.35	plate "oro79"	162
4578	bento Box	120, 240
4579	lid/tray	120, 240
4580	insert/box	120, 122, 240
4581	base tray "Modul"	123, 134
4582	base tray "Modul"	58, 134, 123
4583	base tray "Modul"	123, 134
4584	bridge "Modul"	126, 134
4585	spoon rest "Modul"	126, 134, 137, 274
4586	tray	123, 274
4587	GN tray	123, 274
4588	GN tray	123, 274
4589	GN tray	123, 274
4590	2/8 GN tray	122, 274
4591	cutlery/napkin box	115, 126, 137
4593	tray	126, 274
4594	cutlery box	115, 122
4595.30	tray "Slope"	130, 242, 288
4595.45	tray "Slope"	130, 242, 288
4595.45PB	tray "Slope"	130, 242, 288
4596.30	tray "Slope"	130, 242, 288
4596.45	tray "Slope"	130, 242, 288
4596.45PB	tray "Slope"	130, 242, 288
4597.01	chiller base/tray	42
4597.02	chiller base/tray	42
4598.09	bowl/box	122
4598.13	bowl/box	122
4599.13	bowl/box	122
4606.10	miniature plate	232, 260
4606.17	plate	232, 261
4607.10	miniature plate	232, 260
4607.17	plate	232, 261
4660.01	non-slip mat	139
4660.02	non-slip mat	139
4660.03	non-slip mat	139
4661.05S	coaster	210
4661.05W	coaster	210
4661.07S	coaster	210
4661.07W	coaster	210

item	description	page
4680.S	holder for test tubes	138, 208, 224
4680.W	holder for test tubes	138, 208, 224
4681.S	ring "SelectionA."	56, 69, 158, 167, 184, 211, 228
4681.W	ring "SelectionA."	56, 69, 158, 167, 184, 211, 228
4682.S	pedestal/ring	69, 158, 167, 192
4682.W	pedestal/ring	69, 158, 167, 192
4683	silicone sleeve	90
4684	silicone sleeve	17, 22
4685	protecting cap	8
4700	coaster "Solid"	254
4700.01	coaster "Solid"	181, 254, 282
4703	box "Solid"	252, 270
4704	box "Solid" for inserts up to 7 cm x 7 cm	252, 270
4705	box "Solid"	252
4707.PB	servicing tray "Solid"	108, 246, 289
4708	tray "Solid"	250, 270
4708.G	glass insert/coaster	250
4709	tray "Solid"	250
4709.G	glass insert/coaster	250
4709.G	glass insert/coaster	250
4710	servicing tray "Solid"	114, 250
4711.18	bowl "Solid"	114, 251
4711.24	bowl "Solid"	114, 251
4711.30	bowl "Solid"	114, 251
4712	box "Solid"	252, 270
4713	servicing tray "Solid"	112, 246, 290
4716	tealight holder "Solid"	282
4718	tray stand "Solid"	106
4719	tray "Solid"	252, 270
4720	cutlery box "Solid"	115, 247
4721	base tray "Modul"	127
4722	base tray "Modul"	58, 132
4723	base tray "Modul"	132
4724	bridge "Modul"	132
4725	spoon rest "Modul"	132
4726	card holder	96, 114, 251
4730	bridge "Solid"	111
4731	bridge "Solid"	111
4732.PB	cutting board "Solid"	110
4733	bread cutting board "Solid"	110
4733.R	replacement grate "Solid"	110
4734.01	coaster "Solid"	117, 179, 255
4734.02	coaster "Solid"	117, 179, 255
4734.03	coaster "Solid"	117, 179, 255
4734.04	coaster "Solid"	117, 179, 255
4735	roomservice tray "Solid"	113, 244, 287
4736	walnut connector "Squareline"	22
4737	chocolate/truffle box "Solid"	249
4738	chocolate/truffle box "Solid"	249
4740	servicing tray "Solid"	109, 246
4741	grate insert "Solid"	109
4742	tray insert "Solid"	108
4743	tray insert "Solid"	108
4744	cutlery insert "Solid"	109
4745	tray insert "Solid"	109
4746	tray stand "Solid"	106
4747	connector piece "Solid"	106
4748	tray stand/side table "Solid"	286

quick-finder - list of items in ascending order

item	description	page
4749	ham holder "Solid"	111
4760	bowl "Solid"	114, 251
4761	bowl "Solid"	114, 251
4762.18	storage/presentation box "Solid"	248, 290
4762.18G	glass lid	248, 291
4763.01S	insert for chocolates	248, 291
4763.01W	insert for chocolates	248, 291
4763.02S	insert for cigars	248, 291
4763.02W	insert for cigars	248, 291
4763.03S	insert for coffee capsules	248, 291
4763.03W	insert for coffee capsules	248, 291
4763.04W	insert/platter	248, 291
4766	cutlery/napkin box "Solid"	247, 290
4767.12	buffet display "Solid"	38, 115, 132
4767.24	buffet display "Solid"	38, 115, 132
4768.08	buffet display/basket "Mercato"	104
4768.12	buffet display/basket "Mercato"	104
4768.16	buffet display/basket "Mercato"	104
4769	servicing tray "Solid"	112, 127, 244, 289
4770.24	bread basket "Solid"	251
4772.33PB	wooden pillow "Donna"	145, 292
4773.PB	bed tray „Solid“	113, 245, 287
4774.31PB	cutting/snack board "Connect!"	112, 253
4775.44PB	cutting/snack board "Connect!"	112, 253
4776	cutting board „Solid“	102, 110
4777	stacking ring „Solid“	102
4778	bowl „Solid“	102
4810.01	bowl	73
4810.02	bowl	73
4810.03	bowl	73
4811.01	bowl	73
4811.02	bowl	73
4811.03	bowl	73
4813.28	glass bowl "Duplex"	68
4813.35	glass bowl "Duplex"	68
4813.46	glass bowl "Duplex"	68
4814.17	glass bowl	8, 10, 69, 159, 167
4814.23	glass bowl	8, 10, 69, 167
4814.30	glass bowl	8, 10, 69, 167
4814.40	glass bowl	8, 10, 69, 167
4815.18	glass bowl "Cave"	167, 68
4815.18PB	glass bowl "Cave"	68, 167
4815.24	glass bowl "Cave"	68, 167
4815.24PB	glass bowl "Cave"	68, 167
4850	glass cloche	116, 185, 255
4851	glass cloche	116, 185, 255
4852	glass cloche	102, 116, 185, 255
4853	glass cloche	184
4854.01	glass stand	184
4854.02	glass stand	184
4854.03	glass stand	184
4859.07	small glass bowl	159, 170, 228
4860.07	small glass bowl	159, 170, 228
4880.18	glass cloche	102, 117, 179, 255
4880.22	glass cloche	117, 179, 255
4880.26	glass cloche	102, 117, 179, 255
4880.30	glass cloche	117, 179, 255
4881.26	wine cooler	56
4882.22PB	cloche with wooden coaster and glass insert	117, 179, 255

item	description	page
4882.30PB	cloche with wooden coaster and glass insert	117, 179, 255
4883	decanter/carafe "Eddy"	192
4884.PB	decanter/carafe "Eddy" with ring	192
4885	chopsticks	171, 206
4886	chopstick/knife rest "Flex"	171, 206
4887.PB	chopsticks with knife rest	171, 206
4888.16	platter/miniature "Flex"	206
4888.22	platter/miniature "Flex"	206
4889.16	dip bowl/miniature "Flex"	206
4890	decanter/carafe „Pebble“	201
4890.PB	decanter/carafe „Pebble“	201
4901.01	glass miniature	218
4901.		

quick-finder - list of items in ascending order

item	description	page
4956.03PB	glass bowl	219
4956.04	glass bowl	219
4956.04PB	glass bowl	219
4962	cocktail glass	218
4963.01	small glass bowl	219
4963.02	small glass bowl	219
4963.03	small glass bowl	219
4964	small glass bowl "Halfmoon"	219
4965	glass bowl	211
4980.12	glass straw	218
4980.16	glass straw	208, 218
4982	glass cloche	182, 254
4982.05	glass cloche	98, 180
4982.06	glass cloche	180
4982.07	glass cloche	180
4982.09	glass cloche	181, 254
4982.11	glass cloche	182
4983	vinegar/oil bottle	267
4984	vinegar/oil bottle	267
4985	vinegar/oil bottle	267
4987.01	wind light	181, 282
4987.02	wind light	181, 282
4989	glass tube "Soup Flow"	160, 226
4990.02	glass tube "Sauce Flow"	160, 226
4991.02	wind light	8, 64, 282, 283
4995	small glass creamer	216
4999	charger plate/glass insert	52, 114, 188, 250, 265
5000	buffet platter, clear glass	52
5000.B	buffet platter, dark grey glass	49, 58
5013.46	buffet bowl	72
5014.38	buffet bowl	72
5016.24	glass bowl	172, 182
5020	glass platter, 1/1 GN	174
5024.45	buffet bowl	72
5026.01	glass steps	53
5026.02	glass steps	53
5026.03	glass steps	53
5026.04	glass steps	53
5034	glass miniature plate	234
5034.01	glass miniature plate	180, 234
5039	small glass bowl	234
5039.01	small glass bowl	180, 234
5049.35	buffet bowl	72
5062	glass platter	174
5063	glass platter	72, 174
5063.50	glass platter	72, 174
5064	glass platter	174
5070.01	glass stand	53
5074.01	glass plate "Modul"	137, 161, 220
5075.40	buffet platter	174
5076.01	glass steps	53
5076.02	glass steps	53
5084	glass platter	174
5088	glass plate "Vario"	174
5099	small glass bowl	234
5135.PB	glass tray with bowls	156, 231, 277
5141.26	glass tray	53, 156, 276
5141.34	glass tray	53, 156, 276
5141.50	glass tray	53, 156, 276
5142.34	glass tray	53, 156, 276
5143	glass tray	156, 276
5145	glass tray	156, 180, 276
5160.31	glass tray	57, 72
5160.62	glass tray	57, 72
5161.31	glass tray	57, 72

item	description	page
5161.62	glass tray	57, 72
5166	glass bowl	64, 234, 296
5167	small glass bowl/glass tray	204, 234
5168.06	spoon rest/glass miniature	96, 173
5168.14	glass platter/plate	173
5168.25	glass platter/plate	173
5168.30	glass platter/plate	173
5169.31	glass platter/plate	173
5169.38	glass platter/plate	173
5169.41	glass platter/plate	173
5170.PB	sushi set	171, 173
5172	small glass bowl/spoon rest	96, 235
5173	small glass bowl	235
5174.09	small glass bowl	235
5174.11	small glass bowl	235
5174.14	small glass bowl	235
5175.41	glass bowl	71
5175.44	glass bowl	71
5176	buffet bowl	12, 71
5177.20	glass plate	173
5177.25	glass plate	173
5177.28	glass plate	173
5178.16	glass plate "Unique"	146, 261
5178.21	glass plate "Unique"	77, 146
5178.28	glass plate "Unique"	146
5178.32	glass plate "Unique"	146
5179.16	glass plate "Unique"	147, 261
5179.21	glass plate "Unique"	77, 147
5179.28	glass plate "Unique"	147
5179.32	glass plate "Unique"	147
5180.10	glass bowl "Unique"	146, 228
5180.15	glass bowl "Unique"	146
5181.10	glass plate "Unique"	147, 228
5181.15	glass plate "Unique"	147
5182.16	glass bowl "Unique"	146, 71
5182.21	glass bowl "Unique"	146, 71
5182.27	glass bowl "Unique"	146, 71
5183.16	glass bowl "Unique"	147, 71
5183.21	glass bowl "Unique"	147, 71
5183.27	glass bowl "Unique"	147, 71
5210	ashtray for cigars	96, 228, 278
5240.M	buffet platter/separating plate	52, 28, 83
5241	buffet platter Curve 90°	52
5241.B	buffet platter Curve 90°	49
5242	buffet platter Curve 45°	52
5242.B	buffet platter Curve 45°	49
5243	buffet platter	58, 91
5243.B	buffet platter	49, 91
5243.B	buffet platter, dark grey glass	49, 58
5243.M	buffet platter	52, 58, 91
5244	coaster/glass insert	66, 182, 226, 254, 278
5244.09	coaster/glass insert	66, 181, 226, 254, 278
5244.11	coaster/glass insert	66, 226, 278
5244.17	coaster/glass insert	66, 117, 179, 255, 278
5244.21	coaster/glass insert	66, 117, 179, 255, 278
5244.24	coaster/glass insert	66, 117, 179, 255, 278
5244.28	coaster/glass insert	66, 117, 179, 255, 278
5254	small glass bowl	138, 154, 223, 271
5254.01	glass miniature	154, 223, 271
5255	small glass creamer	154, 223, 271
5257	glass miniature	138, 229
5290.01	glass bottle	225
5290.02	glass bottle	19, 225, 275

item	description	page
5290.02	glass bottle	225, 275
5295.01	glass bottle	225, 271
5295.02	glass bottle	225, 272
5296.01	glass bottle	225, 271
5296.02	glass bottle	225, 271
5297.01	cork	225, 271
5297.02	cork	225, 271
5308	glass bowl	175
5308.08	glass bowl	175, 227
5308.11	glass bowl	175, 227
5308.11D	glass lid	175, 229
5308.20	glass bowl	175
5308.26	glass bowl	175
5317	vinegar/oil bottle	266
5329.14	glass bowl	175
5329.21	glass bowl	175
5329.25	glass bowl	175
5330.08	glass bowl	175, 229
5330.20	glass bowl	175
5330.24	glass bowl	175
5330.29	glass bowl	175
5331.30	glass platter	175, 229
5338	small glass bowl	154, 223, 272
5338.01	glass miniature	154, 223, 154, 272
5346	glass bowl	175
5347	caviar set	175
5349.21	pastry/cake stand	116, 185
5349.28	pastry/cake stand	116, 185
5349.33	pastry/cake stand	116, 185
5350.16	glass cloche	116, 185
5350.23	glass cloche	116, 185
5350.27	glass cloche	116, 185
5351	vinegar/oil bottle	266, 265
5352	glass carafe	19, 175
5380	glass	150, 228, 275, 277
5381	glass	150, 228, 275, 277
5405	glass miniature	138, 88, 208, 228, 264
5415	glass cone	98, 229, 263
5416	small glass creamer	224
5418	small glass bowl/cloche	150, 159, 184, 228
5420	glass miniature	227, 265, 273, 275
5420.01	glass miniature	227, 265, 273, 275
5422	small glass bowl	227
5423.01	glass miniature	227, 138
5423.02	glass miniature	227, 138
5424	small butter & lard pot	224
5428.04	glass tray	223, 262
5440	small glass bowl "Spobo" with spoon rest	153, 231, 277
5441	glass bowl "Duo"	231, 277
5442	small glass bowl	231, 277
5444	glass bowl	126, 231, 275, 277
5445	glass miniature, 2 parts	227
5446.01PB	glass pillow "Donna"	145, 230, 292
5480.01	FRESH	198
5480.02	STRAIGHT	198
5480.03	INTENSE	198
5480.04	BALANCED	199
5480.05	RICH	199
5480.06	NOSTALGIC	199
5481	champagne flute "Vaganza"	202
5481.GPB	champagne flute "Vaganza"	202
5481.PPB	champagne flute "Vaganza"	202

quick-finder - list of items in ascending order

item	description	page
5482.10	glass cloche	140, 183
5482.10PB	glass cloche	140, 183
5482.15	glass cloche	140, 183
5660	hook-and-loop strap	99
5662	hand pump	28, 83
5663.20	cooling pack	42, 166, 221
5665.01	storage/transportation box	11
5665.02	storage/transportation box	11
5700	glass plate	70, 172
5701	glass bowl	70, 172
5702	glass plate	70, 172
5703	buffet bowl	70, 172
5740	glass bottle/creamer	225, 267, 271
5741	miniature glass bottle	224, 267
5760.35	charger plate "Ice"	169, 186
5761.33	charger plate "Ice"	169, 186
5762.16	glass platter "Ice"	169
5762.33	glass platter "Ice"	169
5762.40	glass platter "Ice"	169
7100.36	dinner plate "Capiz"	168, 186
7103.20	tray "Capiz"	168, 294
7103.26	tray "Capiz"	168, 294
7106.46	bowl "Capiz"	65, 168, 294
7109.46	bowl "Capiz"	65
7109.46PB	bowl "Capiz"	65
7112.36	bowl "Capiz"	65
7115.36	charger plate "Capiz"	168, 186
7700	coat rack "Kibu"	298
8001.01	buffet platters "Vintage"	47, 186
8001.02	buffet platters "Vintage"	47
8001.04	buffet platters "Vintage"	47
8001.06	buffet platters "Vintage"	47, 186
8001.08	buffet platters "Vintage"	47, 58, 91
8001.11	buffet platters "Vintage"	47
8001.13	buffet platters "Vintage"	47
8004.01	buffet platter, clear glass	52
8004.01B	buffet platter, dark grey glass	49
8004.02	buffet platter, clear glass	52
8004.02B	buffet platter, dark grey glass	49
8004.03	buffet platter, clear glass	52
8004.03B	buffet platter, dark grey glass	49
8004.04	buffet platter, clear glass	52
8004.04B	buffet platter, dark grey glass	49
8004.05	buffet platter, clear glass	52
8004.05B	buffet platter, dark grey glass	49
8004.06	buffet platter, clear glass	52
8004.06B	buffet platter, dark grey glass	49
8004.07B	buffet platter, dark grey glass	49, 286
8005.01	buffet platter, slate	45
8005.02	buffet platter, slate	45
8005.04	buffet platter, slate	45
8005.05	buffet platter, slate	45
8005.06	buffet platter, slate	45
8005.07	buffet platter, slate	45
8005.21	buffet platter, slate	45
8006.01	buffet platter, laminated plastic	46, 186
8006.02	buffet platter, laminated plastic	46
8006.04	buffet platter, laminated plastic	46
8006.06	buffet platter, laminated plastic	46, 186
8006.11	buffet platter, laminated plastic	46, 58, 91
8006.13	buffet platter, laminated plastic	46
8007.01	buffet platter "Industry 2.0"	47, 186
8007.02	buffet platter "Industry 2.0"	47
8007.04	buffet platter "Industry 2.0"	47
8007.06	buffet platter "Industry 2.0"	47, 186
8007.08	buffet platter „Industry 2.0"	47, 58, 91
8007.11	buffet platter "Industry 2.0"	47

item	description	page
8007.13	buffet platter "Industry 2.0"	47
8008.01	buffet platter, glass	48
8008.02	buffet platter, glass	48, 188
8008.03	buffet platter, glass	48
8008.04	buffet platter, glass	48, 58, 91
8008.05	buffet platter, glass	48
8008.06	buffet platter, glass	48
8008.07	buffet platter, glass	48
8008.08	buffet platter, glass	48
8008.13	buffet platter, glass	48
8011.12	buffet stand "Antique"	38
8011.24	buffet stand "Antique"	38
8011.36	buffet stand "Antique"	38
8013	buffet etagere "Stablo"	57
8014.13	buffet stand "Stablo"	56
8014.20	buffet stand "Stablo"	56
8014.20PB	decanter dry rack "Stablo"	201
8015.20	buffet stand "Stablo" S, M, L	56
8015.30	buffet stand "Stablo" S, M, L	56
8015.40	buffet stand "Stablo" S, M, L	56
8016.01	buffet stand "Stablo" XL-ring	56
8017.40	extension "Stablo"	56
8017.60	extension "Stablo"	56
8017.80	extension "Stablo"	56
8018.01	fingerfood tree	99
8018.T	transport bag	99
8019.01	spring clip support	98
8019.02	ring support	98
8019.03	ring support	98
8019.04	ring support	98
8019.05	spiral support	98
8020	buffet platter 1/1 GN, slate	45
8022.02	marble platter	88, 238
8028	sushi plate	170
8034	bowl	88, 170, 238, 266
8035	sushi plate	170
8038	mortar	239, 266
8051	skewer plate	239
8052	marble platter	88, 238
8070.01PB	illuminated wine cooler with stand gift set "Stablo"	56
8080.04	buffet stand "Basic"	34
8080.08	buffet stand "Basic"	34
8080.16	buffet stand "Basic"	34
8080.24	buffet stand "Basic"	34
8081.13	buffet stand "Squareline"	22
8081.25	buffet stand "Squareline"	22
8082.13	buffet stand "Squareline"	22
8082.25	buffet stand "Squareline"	22
8083.01	acrylic connector "Squareline"	22
8083.02	acrylic connector "Squareline"	22
8084.13	buffet stand "Squareline"	22
8084.25	buffet stand "Squareline"	22
8104	LED-light	40
8104.UK	LED-light	40
8104.USA	LED-light	40
8105.01	colour cover	40
8105.02	colour cover	40
8105.03	colour cover	40
8105.04	colour cover	40
8120.01	acrylic glass tube	40
8120.02	acrylic glass tube	40
8120.03	acrylic glass tube	40
8122.10	acrylic glass tube	16, 40
8122.22	acrylic glass tube	16, 40
8122.34	acrylic glass tube	16, 40
8122.58	acrylic glass tube	16, 40
8130	LED-tealight set	284

item	description	page
8131	LED-tealight	284
8132.EU	power supply	284
8132.UK		

quick-finder - list of items in ascending order

item	description	page	item	description	page	item	description	page
8262.10	buffet display "Spike" L - parts	10	8305.34	buffet stand "Skyline"	16	8320.31	buffet stand "Crossline"	12
8262.1U	buffet display "Spike" L - parts	10	8305.58	buffet stand "Skyline"	16	8320.31R	Buffetständer „Crossline“ - rust	12
8300.10	buffet stand "Skyline"	16	8310.22	buffet stand "Curve"	25	8325.23	buffet stand "Crossline"	12
8300.22	buffet stand "Skyline"	16	8310.46	buffet stand "Curve"	25	8325.23R	buffet stand "Crossline" - rust	12
8300.34	buffet stand "Skyline"	16	8311.22	buffet stand "Curve"	24	8730	buffet bridge "Podia", triple pack	101, 297
8300.58	buffet stand "Skyline"	16	8311.46	buffet stand "Curve"	24	8731	buffet bridge "Podia", triple pack	100, 297
8305.10	buffet stand "Skyline"	16	8320.15	buffet stand "Crossline"	12	8732.03	1/2 GN tray "Podia"	101, 297
8305.22	buffet stand "Skyline"	16	8320.15R	buffet stand "Crossline" - rust	12			

2103.03PB	etagere with plates	93, 261	4774.31PB	cutting/snack board "Connect!"	112, 253
2106.04PB	etagere with miniature plates	92, 260	4775.44PB	cutting/snack board "Connect!"	112, 253
2109.PB	bowl "Loop"	79	4815.18PB	glass bowl "Cave"	68, 167
2159.16PB	bowl	85, 236	4815.24PB	glass bowl "Cave"	68, 167
2159.20PB	bowl	85, 236	4882.22PB	cloche with wooden coaster and glass insert	117, 179, 255
2180.22PB	bowl	80	4882.30PB	cloche with wooden coaster and glass insert	117, 179, 255
2180.30PB	bowl	80	4884.PB	decanter/carafe "Eddy" with ring	192
2189.PB	etagere/pastry stand	256	4887.PB	chopsticks with knife rest	171, 206
2198.PB	etagere	81	4890.PB	decanter/carafe „Pebble“	201
2200.PB	illuminated champagne bowl	83	4914.PB	glass miniature "Amuse"	214
2201.PB	etagere with 3 stage	87, 259	4915.PB	glass miniature "Amuse"	214
2202.PB	etagere with 1 stage	86, 237, 259	4918.PB	glass tin "Amuse"	215
2206.50PB	bowl flat	86	4919.PB	glass tin "Amuse"	215
2261.16PB	bowl "Shine"	61	4920.PB	glass tin "Amuse"	215
2261.20PB	bowl "Shine"	61	4921.PB	glass tin "Amuse"	215
2261.24PB	bowl "Shine"	61	4923.PB	nut bowl "Amuse"	216
2314.01PB	bowl/basket "Reef"	63, 296	4924.01PB	glass miniature "Amuse"	212
2314.02PB	bowl/basket "Reef"	63, 296	4924.02PB	glass miniature "Amuse"	212
2314.03PB	bowl/basket "Reef"	63, 296	4943.08PB	cloche with plateau plate/small bowl "Cuspis"	142, 178, 205
2316.PB	candle holder/wind light "Reef"	64, 283	4943.10PB	cloche with plateau plate/small bowl "Cuspis"	142, 178, 205
2317.PB	napkin ring "Reef"	64, 160	4943.25PB	cloche with plateau plate/small bowl "Cuspis"	142, 178
2336.PB	bowl/basket "Reef"	62	4944.PB	honey spoon with glass tray "Cuspis"	204, 234
2381.38PB	bowl "Roots"	66, 295	4945.PB	decanter/carafe „Star“	190
2384.PB	candle holder/wind light "Somnia"	280	4946.PB	decanter „Star“ with Vision „Straight“	190
2440.25PB	candlestick "Stele"	281	4954.03PB	small glass bowl "Halfmoon"	219
2440.32PB	candlestick "Stele"	281	4956.02PB	glass bowl	219
2440.46PB	candlestick "Stele"	281	4956.03PB	glass bowl	219
2441.25PB	candlestick "Stele"	281	4956.04PB	glass bowl	219
2441.32PB	candlestick "Stele"	281	5135.PB	glass tray with bowls	156, 231, 277
2441.46PB	candlestick "Stele"	281	5170.PB	sushi set	171, 173
4230.14PB	fruit/dessert bowl "Spobo"	152	5446.01PB	glass pillow "Donna"	145, 230, 292
4230.18PB	soup bowl "Spobo"	152	5480.01	FRESH	198
4375.01PB	bowl "Cave"	166, 221	5480.02	STRAIGHT	198
4386.PB	plateau plate "DressCoat"	148	5480.03	INTENSE	198
4387.PB	plateau plate "DressCoat"	148	5480.04	BALANCED	199
4388.PB	plateau plate "DressCoat"	148	5480.05	RICH	199
4389.25PB	plateau plate/bowl "Cuspis"	142, 178	5480.06	NOSTALGIC	199
4399.PB	wind light with coaster	284	5481	champagne flute "Vaganza"	202
4461.01PB	porcelain pillow "Donna"	230, 144	5481.GPB	champagne flute "Vaganza"	202
4461.02PB	porcelain pillow "Donna"	230, 144	5481.PPB	champagne flute "Vaganza"	202
4501.PB	platter "Collina"	151	5482.10PB	Glas-Cloche	140, 183
4504.PB	platter "Collina"	151	7109.46PB	bowl "Capiz"	65
4507.01PB	plate/platter	140	7700	coat rack "Kibu"	298
4507.02PB	plate/platter	140	8014.20PB	decanter dry rack „Stablo“	201
4595.45PB	tray "Slope"	130, 242, 288	8070.01PB	illuminated wine cooler with stand gift set "Stablo"	56
4596.45PB	tray "Slope"	130, 242, 288			
4707.PB	serving tray "Solid"	108, 246, 289			
4732.PB	cutting board "Solid"	110			
4772.33PB	wooden pillow "Donna"	145, 292			
4773.PB	bed tray „Solid“	113, 245, 288			

4774.31PB	cutting/snack board "Connect!"	112, 253
4775.44PB	cutting/snack board "Connect!"	112, 253
4815.18PB	glass bowl "Cave"	68, 167
4815.24PB	glass bowl "Cave"	68, 167
4882.22PB	cloche with wooden coaster and glass insert	117, 179, 255
4882.30PB	cloche with wooden coaster and glass insert	117, 179, 255
4884.PB	decanter/carafe "Eddy" with ring	192
4887.PB	chopsticks with knife rest	171, 206
4890.PB	decanter/carafe „Pebble“	201
4914.PB	glass miniature "Amuse"	214
4915.PB	glass miniature "Amuse"	214
4918.PB	glass tin "Amuse"	215
4919.PB	glass tin "Amuse"	215
4920.PB	glass tin "Amuse"	215
4921.PB	glass tin "Amuse"	215
4923.PB	nut bowl "Amuse"	216
4924.01PB	glass miniature "Amuse"	212
4924.02PB	glass miniature "Amuse"	212
4943.08PB	cloche with plateau plate/small bowl "Cuspis"	142, 178, 205
4943.10PB	cloche with plateau plate/small bowl "Cuspis"	142, 178, 205
4943.25PB	cloche with plateau plate/small bowl "Cuspis"	142, 178
4944.PB	honey spoon with glass tray "Cuspis"	204, 234
4945.PB	decanter/carafe „Star“	190
4946.PB	decanter „Star“ with Vision „Straight“	190
4954.03PB	small glass bowl "Halfmoon"	219
4956.02PB	glass bowl	219
4956.03PB	glass bowl	219
4956.04PB	glass bowl	219
5135.PB	glass tray with bowls	156, 231, 277
5170.PB	sushi set	171, 173
5446.01PB	glass pillow "Donna"	145, 230, 292
5480.01	FRESH	198
5480.02	STRAIGHT	198
5480.03	INTENSE	198
5480.04	BALANCED	199
5480.05	RICH	199
5480.06	NOSTALGIC	199
5481	champagne flute "Vaganza"	202
5481.GPB	champagne flute "Vaganza"	202
5481.PPB	champagne flute "Vaganza"	202
5482.10PB	Glas-Cloche	140, 183
7109.46PB	bowl "Capiz"	65
7700	coat rack "Kibu"	298
8014.20PB	decanter dry rack „Stablo“	201
8070.01PB	illuminated wine cooler with stand gift set "Stablo"	56



selection

Zieher "Selection" consists of an exclusive choice of innovative products, which are now made accessible to the high class retail market and thus becoming available for every design favouring end user with a sense for the extraordinary. These items are delivered in gift boxes.

quick-finder - A to Z glossary

A		
acrylic adapter "Squareline"		22
acrylic insert for wine cooler		18
acrylic tubes		16, 40
"Amuse"		212-216
Amuse Gueule stand		86, 89, 237, 238
amuse gueule/tapas spoon		137, 161, 233
"Antique"		38
anti-slip mats "Modul"		139
anti-slip pads		210
"Art de Buffet"		78-95
"Artisan"		74, 75
ashtray		96, 228, 278

B		
BALANCED		199
banquet stand		96
base station for rechargeable LED-light		41
base trays "Modul"		132, 134
"Basic"		34, 35
basket "Mercato"		104, 105
baskets/bowls "Reef"		62-64
bed tray "Solid", walnut		113, 245, 287
"Bento Box", melamine		120, 121, 240
black glass		50, 53, 156, 234
borosilicate glass		178-182, 190-193, 204-219
bottles, glass		19, 225, 266, 267
bowl, XXL		28, 83
bowl "Capiz"		65
bowl "Cuspis"		142, 205
bowl/display "Fakir"		66
bowl, granite		239
bowl "Loop"		79
bowl "Matrix"		66
bowl "Roots"		66
bowls/baskets "Reef"		62-64
bowls, china		142, 148, 152, 162-166
bowls, glass		8, 10, 68-73, 146, 147, 167, 172-175
boxes melamine		115, 120-125, 137, 240
bowls "Solid", walnut		102, 114, 250-252
bowls, stainless steel		61, 74, 78-86, 236, 237
boxes, walnut		38, 115, 244-249, 290, 291
boxes, glass		154, 223, 271, 272
bread basket/box "Solid", walnut		251, 252
bread basket/pastry bowl, stainless steel		84, 85
bread cutting board, walnut		102, 110, 112, 253
bridge, melamine		126, 134
bridge, wood		100, 101, 111, 132
buffet bowls, brass		66, 67
buffet bowls "Capiz"		65
buffet bowls, china		165
buffet bowls "Duplex"		68
buffet bowls "Fakir"		66
buffet bowls, glass		8, 10, 68-73, 167, 172-175
buffet bowls "Loop"		79
buffet bowls "Matrix"		66
buffet bowls "Reef", pewter		62-64
buffet bowls "Roots"		66
buffet bowls, shell		65
buffet bowls "Shine"		61
buffet bowls, stainless steel		61, 74, 78-86
buffet bridges "Podia"		100, 101, 297
buffet columns		38, 40
buffet columns "Antique"		38
buffet display "Classy"		36, 37
buffet display "Konkret!"		27-29

buffet display "Luxor"		30, 31
buffet display "Mercato"		104, 105
buffet display "Solid"		38, 102-115
buffet display "Somnia"		8, 9
buffet display "Spike"		10, 11
buffet display "Textura"		6, 7
buffet display "V12"		32, 33
buffet etageres		57, 75, 77, 81, 87-94
buffet platters, black glass		50
buffet platters, glass		48-53, 57
buffet platters, grey glass		49
buffet platters, laminated plastic		46, 47
buffet platters, marble		88
buffet platters, overview		44
buffet platters, satined glass		52
buffet platters, slate		45
buffet platters, structured glass		48
buffet platters, transparent glass		52
buffet platters, white glass		51
buffet sign		96
buffet stands "Basic"		34, 35
buffet stands "Crossline"		12, 13
buffet stands "Curve"		24, 25
buffet stands "Skyline"		14-19
buffet stands "Squareline"		20-23
buffet stands "Stablo"		54-58
buffet steps		53
buffet system "Antique"		38
buffet system "Basic"		34, 35
buffet system "Classy"		36, 37
buffet system "Curve"		24, 25
buffet system "Konkret!"		27-29
buffet system "Lightning Buffet"		39-41
buffet system "Luxor"		30, 31
buffet system "Mercato"		104, 105
buffet system "Skyline"		14-19
buffet system "Solid"		38, 102-115
buffet systems overview		26
buffet system "Squareline"		20-23
buffet system "Stablo"		54-58
buffet system "V12"		32, 33
buffet trays, stainless steel		75, 85, 91-94
butter/lard pot		224

C		
cake-/pastry stand		116, 185, 256-261
candle holder/windlights		279-284
"Capiz"		65, 168
carafe/wine decanter "Pebble"		201
carafe/wine decanter "Star"		190, 191
card holders		96
"Catering", "Catering de Luxe"		164, 165
"Cave"		68, 166, 221
caviar cooler		175, 227
champagne flute "Vaganza"		202
champagne/wine cooler		18, 28, 56, 65, 83, 84
charger plates		158, 186-188
charger plates, china		158
charger plates, glass		169, 186-188
charger plates, laminated plastic		186
charger plates, shell		168, 186
charger plates, slate		186
charger plates, stainless steel		74, 188
"Chiller-Base"		42, 43
china ball "oro79"		162
china bowls		142, 148, 152, 162-166
china creamer		164, 222, 230, 232
china miniatures		205, 220-222, 230-233

china plates		140-144, 148-155, 157-165
china platter "Collina"		150, 151
china platter "Dots"		154
china platters		140, 144, 150-155, 162
china series "Catering		

quick-finder - A to Z glossary

F	
"Fakir"	66, 67
"Fingerfood-Tree"	97-99
"Flex"	206, 207
"Flow"	160, 226
"Flower-Tower" etageres	87, 259
fondue set, two parts	165
food display, stainless steel	263
FRESH	198
fruit/bread basket "Reef"	62-64
fruit/bread basket "Skyline"	18
fruit/bread basket "Solid"	102-104, 250-252
fruit/bread basket, stainless steel	18, 84, 85
fruit/dessert bowl "Spobo"	152, 153

G	
glass bottles	19, 225, 266, 267
glass bowls	8, 10, 68-73, 146, 147, 167, 172-175
glass bowls "Unique"	71, 146, 147, 228
glass boxes	154, 223, 271, 272
glass cloches	102, 116, 117, 177-185, 205, 212, 254-256
glass coaster	226, 254, 255
glass decanter	19, 175, 190-193, 201
glass, double-walled	214, 217-219
glass inserts	66, 108, 114, 179-182, 250, 255
glass miniatures	204-234
glass pillow "Donna"	145, 292
glass plates	146, 147, 156, 169-175
glass plates "Unique"	146, 147
glass platters	48-53, 57, 70-73, 169-175
glass saucer	226, 254, 255
glass series "Amuse"	212-216
glass series "Flex"	206, 207
glass series "Lacuna"	208, 209
glass series "VISION"	194-200
glass spoon "Cuspis"	204, 233
glass stand for buffet steps	53
glass stand for glass cloche	184, 185
glass steps	53
glass straw	208, 218
glass trays	53, 57, 72, 156, 173-175
glass tubes "Sauce Flow"/"Soup Flow"	160, 226
glass wind lamp	280-283
GN trays	101, 123
GN trays, genuine wood veneer	101
GN trays, melamine	123
granite bowls	238, 266
grate "Solid", walnut	109, 110
grey glass	48, 49, 53, 68-72, 167, 172, 173

H	
"Halfmoon"	219
ham holder "Solid"	111
handpump	28, 83
holder for table numbers	96
holder for test tubes	138, 208, 224
honey spoon "Cuspis"	204, 233, 234
hook and loop strap for "Fingerfood-Tree"	99

I	
"Ice"	169
ice cube/chocolate tongs	95, 249
ice cream cup	86, 237
"Industry 2.0" buffet platters	47
insert for chocolates "Solid"	248, 291
insert for cigars "Solid"	248, 291

J	
jam/dressing jar	96
jam trays	223, 233, 262, 268
juice glass	118, 228
juice jug	19, 175

K	
"Kibu" coat rack	298
knife-/chopstick rest	171, 206
"Konkret!"	27-29

L	
"Lacuna"	208, 209
laminated plastic platters	46, 47, 186
lard pot	224
latte macchiato glass	218
LED-light, cabled	40
LED-light, rechargeable	41
LED-tealight/set/equipment	284
"Lightning Buffet"	39-41
longdrink glass	218
"Loop"	79
"Luxor"	30, 31

M	
marble platter	88, 238
"Matrix"	66, 67
melamine "Bento Box"	120, 121, 240
melamine boxes	115, 120-125, 137, 240
melamine bridge	126, 134
melamine cutlery/napkin box	115, 122, 137
melamine spoon rest	126, 134, 137
melamine trays	120-130, 134, 240-243, 274, 288
"Ménage-à-trois"	273
"Mercato"	104, 105
mini fork/spoon	233
miniature cloches	178, 180-184
miniatures	203-239
miniatures, china	205, 220-222, 230-233
miniatures, glass	204-234
miniatures, stainless steel	235-239
"Modul"	131-139, 161, 220
mortar, marble	239, 266

N	
napkin/cutlery box, melamine	115, 122, 137
napkin/cutlery box, wood	115, 127, 247
napkinring	160
NOSTALGIC	199
nut bowl "Amuse"	216

O	
oil/dip bowl	206, 220
"oro79"	162

P	
party spoon, china	233
party spoon, stainless steel	136, 233
pasta plate, china	165
pastry/bread bowl, stainless steel	84, 85
pastry/cake stand	116, 185, 256-261
"Pebble"	201
pepper mill	271

insert for coffee capsules "Solid"	248, 291
insert for serving tray "Solid", walnut	108, 109
insert for wine cooler "Skyline"	18
INTENSE	198

P	
Petit Four stand	86, 89, 237, 238
pillow "Donna", china	144
pillow "Donna", glass	145, 292
pillow "Donna", wood	145, 292
plateau plate "Cuspis", china	142, 143
plateau plate "DressCoat", china	148, 149
plates, china	140-144, 148-155, 157-165
plates, glass	146, 147, 156, 169-175
plate/saucer, wood	117, 179-182, 253-255
platter, china	140, 144, 150-155, 162
platter "Collina"	150, 151
platter "Dots"	154
platter, glass	48-53, 57, 70-73, 169-175
platter "Ice"	169
platter, laminated plastic	46, 47, 186
platter, marble	88, 238
platter, slate	45, 186, 239
platter "Velo"	155
"Podia"	100, 101, 297
porcelain pillow "Donna"	144
presentation box "Solid"	248, 249, 291
protecting cap for "Somnia" displays	8
"Pulsar"	140, 141
pump for meltwater	28, 83

R	
rack for XXL-bowl "Konkret"	28
rechargeable LED-light	41
"Reef"	62-64, 283, 296
remote control for rechargeable LED-light	41
replacement grate "Solid", walnut	109, 110
RICH	199
ring support for "Fingerfood-Tree"	98
rings "SelectionA.", silicone	69, 158, 167, 192, 211, 224
roomservice tray "Solid", walnut	113, 245, 287
"Roots"	66, 67

S	
salt/pepper mills	271
"Sauce Flow"	160, 226
saucer, glass	226, 254, 255
saucer, silicone	139, 210
saucer, wood	117, 179-182, 253-255
"SelectionA."	157-159
serving etageres	256-261
serving tongs	95
serving trays, melamine	120-130, 134, 240-243, 274, 288
serving trays, wood	101, 108-117, 127, 132, 145, 244-255
shell displays "Luxor"	30, 31
shell series "Capiz"	65, 168
"Shine"	61
side table/tray stand "Solid"	286
silicone holder for test tubes	138, 208, 224
silicone pads/coasters	139, 210
silicone rings "SelectionA."	69, 158, 167, 192, 211, 224
silicone sleeve	17, 22, 90, 139
"Sixth Sense"	78
skewer platter	88, 238, 239
skewers, stainless steel	88, 239
"Skyline"	14-19
slate platters	45, 186, 239
"Slope"	130, 242, 288
small glass bowls	204-234
"Solid"	38, 102-117, 127, 244-255, 286-291

T	
test tube	138, 224
"Textura"	6, 7
thermo bowls "Shine"	61
thermo glass	214, 217-219
three-part platter/trays	274-277
toast stand, stainless steel	95, 258
tongs holder, stainless steel	95
tongs, stainless steel	95
transportation/storage box	11, 17
transport bag for "Fingerfood-Tree"	99
tray inserts "Solid"	108, 109
trays for jam	223, 262, 268
trays glass	53, 57, 72, 156, 173-175
trays, melamine	120-130, 134, 240-243, 274, 288
trays, stainless steel	57, 75, 85, 91-94, 233, 256, 258, 262, 269
tray stand/side table "Solid"	286
tray stands "Solid"	106, 286
trays wood	101, 108-117, 127, 132, 145, 244-255
tubes, acrylic glass	16, 40
tubes "Sauce Flow"/"Soup Flow"	160, 226

U	
"Unique"	71, 146, 147, 228

V	
"V12"	32, 33
"Vaganza"	202
"Velo"	155
vinegar/oil bottle, glass	224, 225, 266, 267
"Vintage" buffet platters	47
"VISION"	194-200

W	
walnut adapter "Squareline"	22
walnut bowls "Solid"	102, 114, 250-252
water glass	199, 218, 228
white glass	51
wind lights/candle holders	279-284
wine decanter/carafe "Eddy"	192, 193
wine decanter/carafe "Pebble"	201
wine decanter/carafe "Star"	190, 191
wine/champagne cooler	18, 28, 56, 65, 83, 84
wine glasses "VISION"	194-200
"Wings" bowl	79
wooden bowls	102, 114, 250-252
wooden boxes "Solid"	38, 115, 244-249, 290, 291
wooden bridges	100, 101, 111, 132
wooden pillow "Donna"	145, 292
wooden trays/platters	101, 108-117, 127, 132, 145, 244-255

X	
XXL bowl, concrete semblance	28
XXL bowl, stainless steel	83

quick-finder - A to Z glossary

storage/transportation box	11, 17
STRAIGHT	198
strap for "Fingerfood-Tree"	99
straw, glass	208, 218
sushi platter	94, 154-156, 162, 169-174

T	
test tube	138, 224
"Textura"	6, 7
thermo bowls "Shine"	61
thermo glass	214, 217-219
three-part platter/trays	274-277
toast stand, stainless steel	95, 258
tongs holder, stainless steel	95
tongs, stainless steel	95
transportation/storage box	11, 17
transport bag for "Fingerfood-Tree"	99
tray inserts "Solid"	108, 109
trays for jam	223, 262, 268
trays glass	53, 57, 72, 156, 173-175
trays, melamine	120-130, 134, 240-243, 274, 288
trays, stainless steel	57, 75, 85, 91-94, 233, 256, 258, 262, 269
tray stand/side table "Solid"	286
tray stands "Solid"	106, 286
trays wood	101, 108-117, 127, 132, 145, 244-255
tubes, acrylic glass	16, 40
tubes "Sauce Flow"/"Soup Flow"	160, 226

U	
"Unique"	71, 146, 147, 228

storage/transportation box	11, 17
STRAIGHT	198
strap for "Fingerfood-Tree"	99
straw, glass	208, 218
sushi platter	94, 154-156, 162, 169-174

T	
test tube	138, 224
"Textura"	6, 7
thermo bowls "Shine"	61
thermo glass	214, 217-219
three-part platter/trays	274-277
toast stand, stainless steel	95, 258
tongs holder, stainless steel	95
tongs, stainless steel	95
transportation/storage box	11, 17
transport bag for "Fingerfood-Tree"	99
tray inserts "Solid"	108, 109
trays for jam	223, 262, 268
trays glass	53, 57, 72, 156, 173-175
trays, melamine	120-130, 134, 240-243, 274, 288
trays, stainless steel	57, 75, 85, 91-94, 233, 256, 258, 262, 269
tray stand/side table "Solid"	286
tray stands "Solid"	106, 286
trays wood	101, 108-117, 127, 132, 145, 244-255
tubes, acrylic glass	16, 40
tubes "Sauce Flow"/"Soup Flow"	160, 226

U	
"Unique"	71, 146, 147, 228

storage/transportation box	11, 17
STRAIGHT	198
strap for "Fingerfood-Tree"	99
straw, glass	208, 218
sushi platter	94, 154-156, 162, 169-174

T	
test tube	138, 224
"Textura"	6, 7
thermo bowls "Shine"	61
thermo glass	214, 217-219
three-part platter/trays	274-277
toast stand, stainless steel	95, 258
tongs holder, stainless steel	95
tongs, stainless steel	95
transportation/storage box	11, 17
transport bag for "Fingerfood-Tree"	99
tray inserts "Solid"	108, 109
trays for jam	223, 262, 268
trays glass	53, 57, 72, 156, 173-175
trays, melamine	120-130, 134, 240-243, 274, 288
trays, stainless steel	57, 75, 85, 91-94, 233, 256, 258, 262, 269
tray stand/side table "Solid"	286
tray stands "Solid"	106, 286
trays wood	101, 108-117, 127, 132, 145, 244-255
tubes, acrylic glass	16, 40
tubes "Sauce Flow"/"Soup Flow"	160, 226

U	
"Unique"	71, 146, 147, 228

V	
"V12"	32, 33
"Vaganza"	202
"Velo"	155
vinegar/oil bottle, glass	224, 225, 266, 267
"Vintage" buffet platters	47
"VISION"	194-200

W	
---	--

Glass and china refinement:

Large-scale coatings on glass and china in precious colours enrich every dining table and create luxurious accents!

In order to achieve this decorative style, available in gold, platinum and bronze, the precious metals are burnt onto the varnish at more than 880 °C and as a result the coating is dishwasher-safe. Cloches made of glass can now be used for serving warm dishes as well and condensing water remains invisible to a great part.

By using resistant precious alloys we obtain a connection to the varnish which is strong enough for the products to become dishwasher-safe. Test series by the "Institut für Werkstoffe Heraeus Precious Metals GmbH & Co. KG" have proven the dishwasher resistance of the décor.



Partially, the possibilities of coating are dependent on the form of the product. Requests are being tested in each case according to their feasibility.

The bronze colour is a special case since it presents itself in numerous interesting shades of colour. Depending on the shape of the product, especially when looking at immersions, the colours can vary from gold-bronze shades to blue-violet ones which blend into each other and create unique effects.

Since the products are refined in Germany, specific patterns/orders are usually executed quickly. Please do not hesitate to send us your special request!



Please note:

Products are dishwasher-resistant. Please take note of the instructions given by dishwasher producers and detergents to avoid damage.

Since the coatings are made of precious metals, the use in microwaves is not recommended under any circumstances.



stainless steel (page 309)



structured glass



glass and china

Stainless steel refinement through PVD-technology

Highly polished and matt stainless steel can be refined by using PVD-technology to obtain golden, copper and black colouring.

PVD stands for **Physical Vapour Deposition** and describes a method to coat products with different materials by way of sputtering in a vacuum. Contrary to the galvanic refinement, for example with copper, items refined by using PVD-technology will neither oxidise nor tarnish at the surface. Thus any copper refinement can be done without applying specific anti-tarnish protection. The technical feasibility of the PVD-refinement depends on size and shape of the items and has to be checked individually. Price, minimum order quantity and delivery time upon request!

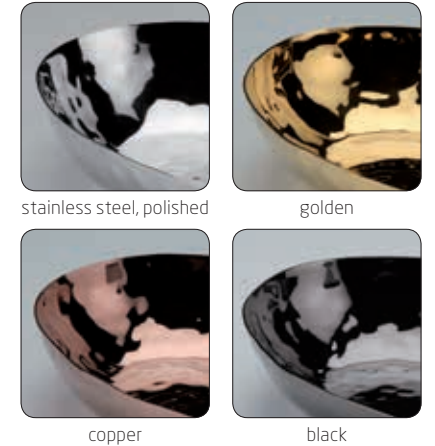

stainless steel, polished

golden

copper

black

Advantages of the PVD-coating

- Food-safe
- Dishwasher-safe
- Better strength and adherence compared to galvanic refinement
- Brilliant colouring, colourfast and resistant against UV radiation

Powder-coating:

All items made of stainless steel can be powder-coated in all current RAL colours upon request. In contrast to the PVD refining this coating is not dishwasher-safe. We will be delighted to advise you!

Please ask us, we will gladly prepare an individual offer for you!

Individuality in glass ...



Logos, letterings etc. can be put on the double walled glasses to give them an individual touch. Those are applied onto the outer side of the inner glass which ensures the protection from dirt and abrasion.

... melamine ...



... china ...



... and stainless steel!

"Curve", pages 24 / 25



"Podia", pages 100 / 101



"Somnia", pages 8 / 9



"Luxor", pages 30 / 31



"Mercato", pages 104 / 105



"Basic", pages 34 / 35



"Spike", pages 10 / 11



"Squareline", pages 20 - 23



"Konkret!", pages 27 - 29



"Solid", pages 102 - 117

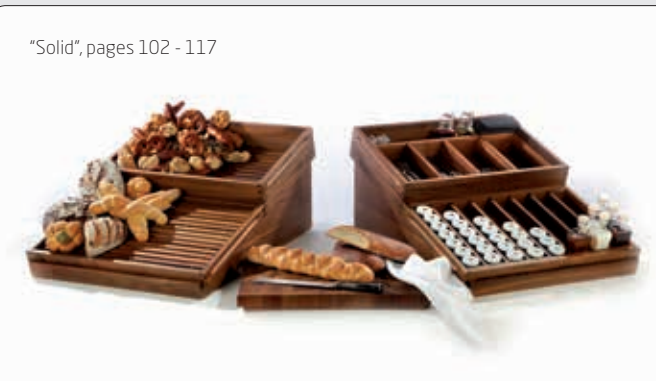

"Skyline", pages 14 - 19

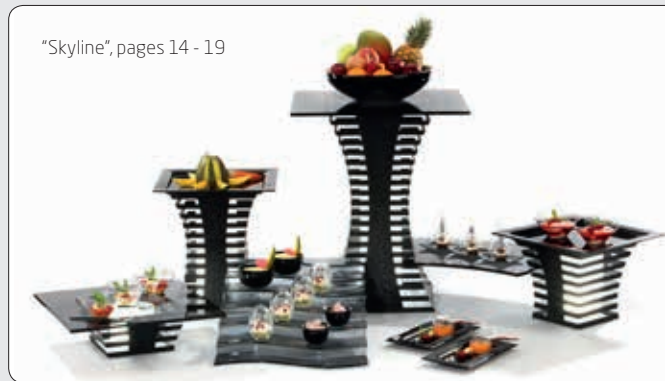

"Textura", pages 6 / 7



"Solid", pages 102 - 117



"V12"- Carbon, pages 32 / 33



"Crossline", pages 12 / 13



"Skyline", pages 14 - 19



"Squareline", pages 20 - 23



"Classy", pages 36 / 37



"Konkret!", pages 27 - 29



"Crossline", pages 12 / 13



Our partners, fans and friends, among them many top chefs and sommeliers from all over the world, are using Zieher products to stage drinks and dishes and to present them on social media.

Below is a great collection of very special Zieher moments. Thanks so much for your creativity!



4 Olivier Gagne, [instagram.com/oliviergagne38](https://www.instagram.com/oliviergagne38) | 1, 11 MH Cocktail Entertainment, Drink Design by Cocktail World Champion Mario Hofferer, mario-hofferer.com, Fotograf Tine Steinthaler | 5 Andy Gaskin, [instagram.com/kitchenandy0808](https://www.instagram.com/kitchenandy0808) | 3, 14 Fabian Sanger, Sweet Life: Rezepte fur Patisserie | 8, 9, 10, 12 Hane Garza, Workshop TallerJO, Monterrey, Mexico | 6, 7 eat! Berlin bei Kunst&Kulinarik | 13 Daniel Klein, Restaurant [KOOK] 36 in Moos | 2 Ulric Nijs, bar-face.com

Follow us on social media and stay tuned!

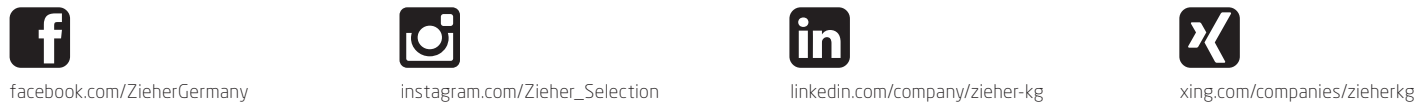

facebook.com/ZieherGermany

[instagram.com/Zieher_Selection](https://www.instagram.com/Zieher_Selection)

[linkedin.com/company/zieher-kg](https://www.linkedin.com/company/zieher-kg)

[xing.com/companies/zieherkg](https://www.xing.com/companies/zieherkg)



The founders of the company Christa (middle) and Manfred Zieher (2nd from left) with their sons Dominik (left) and Oliver (right), responsible for global sales resp. marketing and design. Daughter Jennifer (2nd from right) is in charge of controlling.

30 years of culinary art by Thomas Dotzer:

- 30 years of friendship
- 30 years of culinary highlights
- 30 years of know-how, consultancy and expertise
- 30 years of food-styling and dexterity
- 30 years of support and inspiration

30 years of visual arts by Gerd Preiss:

- 30 years of perspective and composition
- 30 years of pictorial language and emotion
- 30 years of food-styling and photography
- 30 years of know-how and consultancy
- 30 years of commitment, support and friendship



Gerd Prei

Thomas Dotzer

Many thanks!

Our experts after work:

Thomas Dotzer, Dotzer Restauration (www.doetzers.de)

Gerd Prei, Photographer (www.die-lichtzeichner.de)



ZIEHER KG

Kulmbacher Str. 15
95502 Himmelkron
Germany

Tel.: +49 9273 / 92 73 40
Fax: +49 9273 / 92 73 74
E-Mail: info@zieher.com

WWW.ZIEHER.COM

Valid until **February 29th, 2020**