

**PADERNO®**

**WORLD CUISINE**

PARTNER OF THE BEST CUISINE

# CATALOGUE 2021

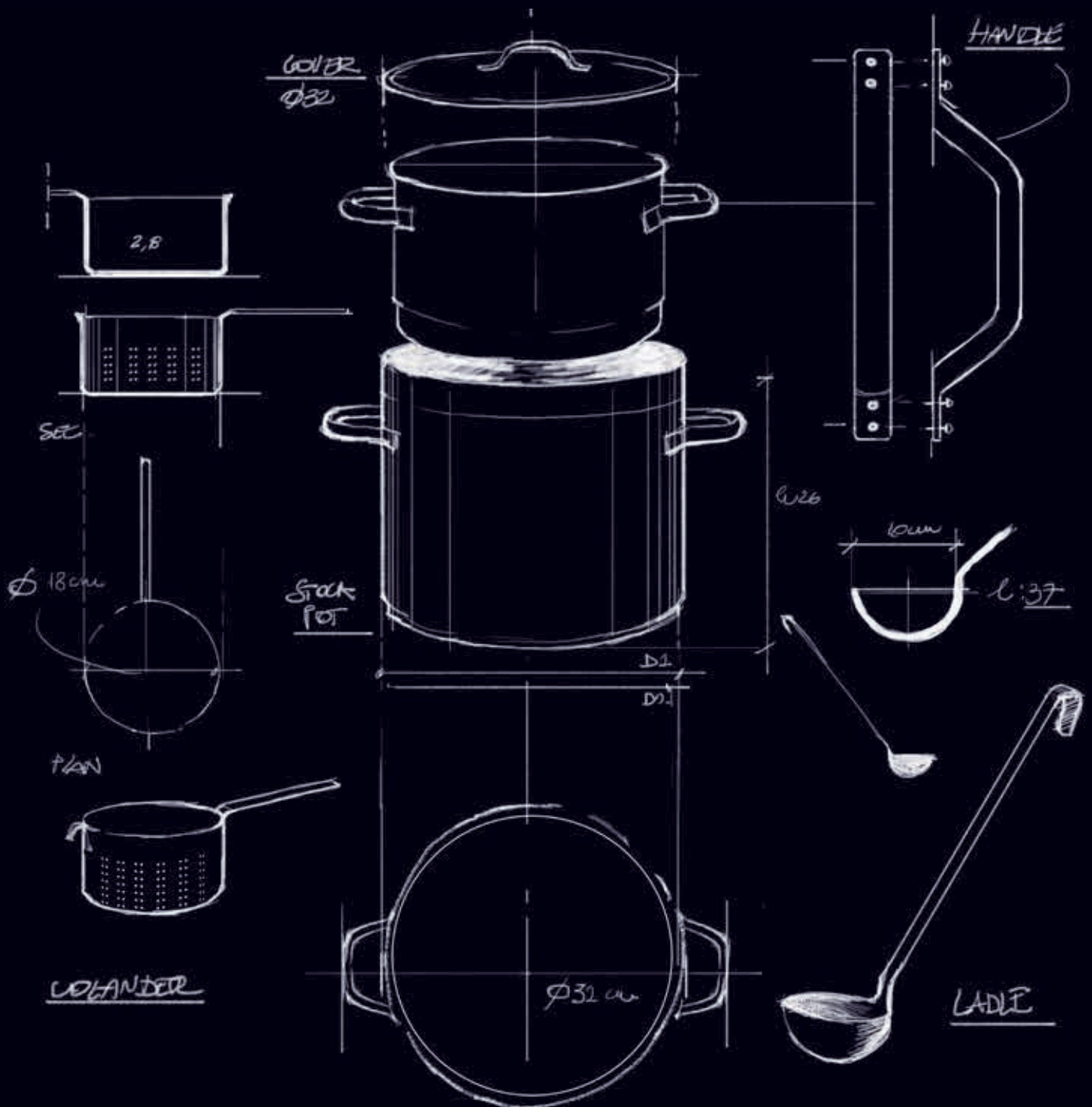



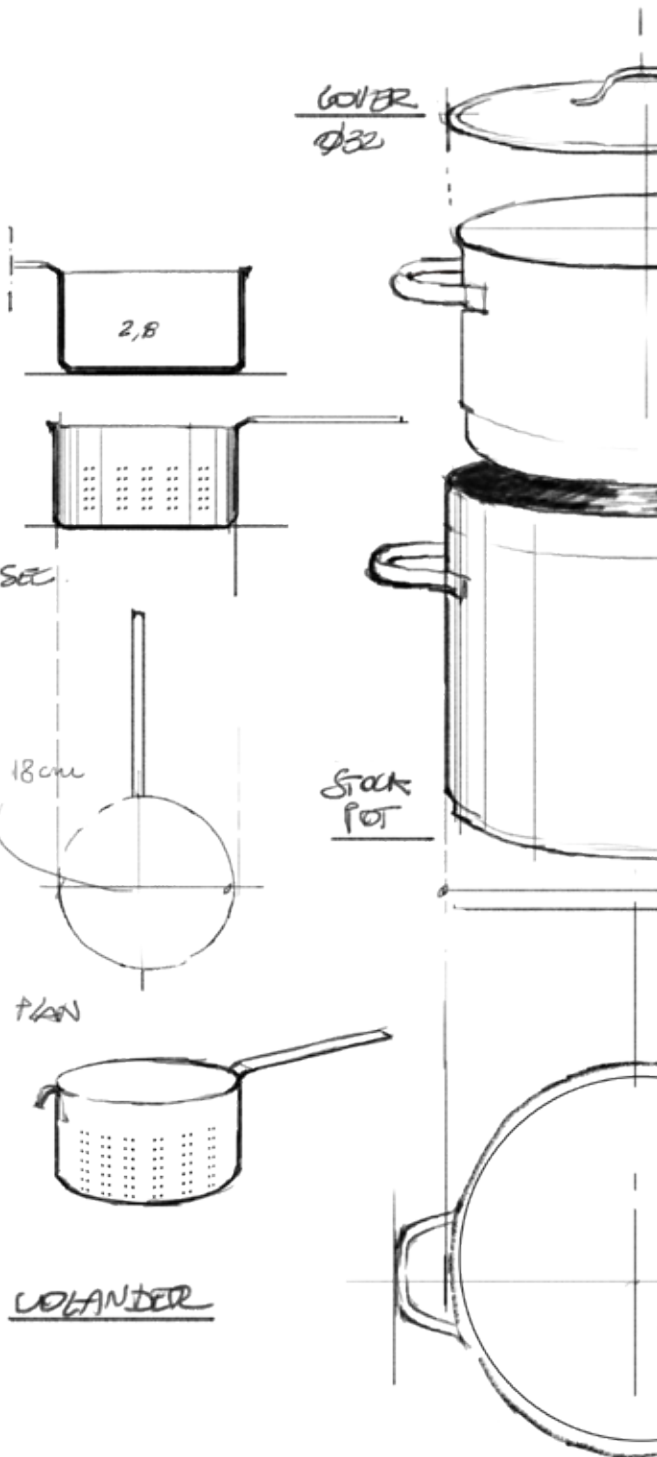

Dear partners,

despite the latest health emergency, we never stopped even during the lockdown and we never lost our optimism.

As proof of our commitment and confidence in the future, we proudly publish today the new edition of the Paderno catalogue, an essential tool for chefs and professionals. You will find a richer range of products and a review of prices in many categories, to present you an increasingly competitive and quality offer.

In recent months we have also worked to support all our clients through constant communication, strengthening our customer service and investing in the creation of further business opportunities, introducing for example new **drop shipment** solutions. Smart working and the most modern software infrastructures are the key points in our Digital Transformation process, that involves Paderno and all the brands of the Arcturus Group.

We are aware that especially in hard times it is important to be close to each other. That's why, today more than ever, we remain at your side.

Cari partner,

nonostante le difficoltà legate alla recente emergenza sanitaria, durante il periodo di lockdown non ci siamo mai fermati e non abbiamo mai perso l'ottimismo.

A testimonianza del nostro impegno e della fiducia che riponiamo nel futuro, è quindi con estremo orgoglio che pubblichiamo oggi la nuova edizione del catalogo Paderno, strumento indispensabile per gli chef e tutti i professionisti del mondo della ristorazione. Troverete una gamma di prodotti sempre più ricca e una revisione dei prezzi in molte categorie, così da presentarvi un'offerta sempre più competitiva e di qualità.

In questi mesi abbiamo inoltre lavorato per supportare tutti i nostri clienti attraverso una costante comunicazione, potenziando il nostro servizio di assistenza e investendo nella creazione di ulteriori opportunità commerciali, ad esempio introducendo nuove soluzioni di **drop shipment**. Smart working e le più moderne infrastrutture software sono i punti cardine nel nostro percorso di Digital Transformation per Arthur Krupp e tutti i marchi del gruppo Arcturus.

Siamo consapevoli che è proprio nei momenti di difficoltà che è importante esservi vicini.

Ecco perché, oggi più che mai, restiamo al vostro fianco.

  
Giovanni Coppo  
Marketing Director

Sambonet Paderno Industrie SpA

# Factory

**A COMPLETE RANGE FOR EVERY NEED IN THE KITCHEN.  
MORE THAN 10.000 ITEMS DEDICATED TO CHEFS AND  
PASSIONATE GOURMANDS.**

From the cookware to the kitchen utensils, then knives, bakery items and tools for every kind of preparation, Paderno offers a complete selection for the best kitchens of houses and restaurants. A brand that finds its origins back in 1925 in Milan as "Alluminio Paderno", specializing in household cookware before it decided to focus on the professional cooking world. With over 90 years of history and a strong worldwide presence, Paderno is the premier choice for professionals in the catering sector. In addition to the production items, the brand offers a remarkable range of complementary articles, carefully selected and crafted by highly qualified companies.

**UNA GAMMA COMPLETA PER OGNI ESIGENZA IN CUCINA.  
OLTRE 10.000 ARTICOLI COMPONGONO L'OFFERTA  
DEDICATA A CHEF E APPASSIONATI GOURMET.**

Dal pentolame agli utensili cucina, passando per coltelli, articoli da pasticceria e strumenti per ogni tipo di preparazione, Paderno offre una selezione completa per le migliori cucine di case e ristoranti. Il Brand trova le sue origini nel 1925 nei pressi di Milano come Alluminio Paderno, specializzato nel settore della cucina casalinga per poi passare al settore professionale. Forte di oltre 90 anni di storia e di una presenza capillare in tutto il mondo, Paderno è il punto di riferimento per tutti i professionisti della ristorazione. Agli articoli di produzione il brand affianca un'importante gamma di prodotti complementari e affini, accuratamente selezionati e realizzati da ditte altamente qualificate.



## **Ho.Re.Ca.**

T 0321 19 16 601  
F 0321 19 16 890

[horeca@paderno.it](mailto:horeca@paderno.it)  
[horeca@sambonet.it](mailto:horeca@sambonet.it)

## **Retail**

T 0321 19 16 701  
F 0321 19 16 830

[retail.italia@sambonet.it](mailto:retail.italia@sambonet.it)  
[retail.international@sambonet.it](mailto:retail.international@sambonet.it)

## **Return**

T 0321 19 16 635 - 759

[returns@sambonet.it](mailto:returns@sambonet.it)

[www.paderno.it](http://www.paderno.it)  
[www.hotel.paderno.it](http://www.hotel.paderno.it)

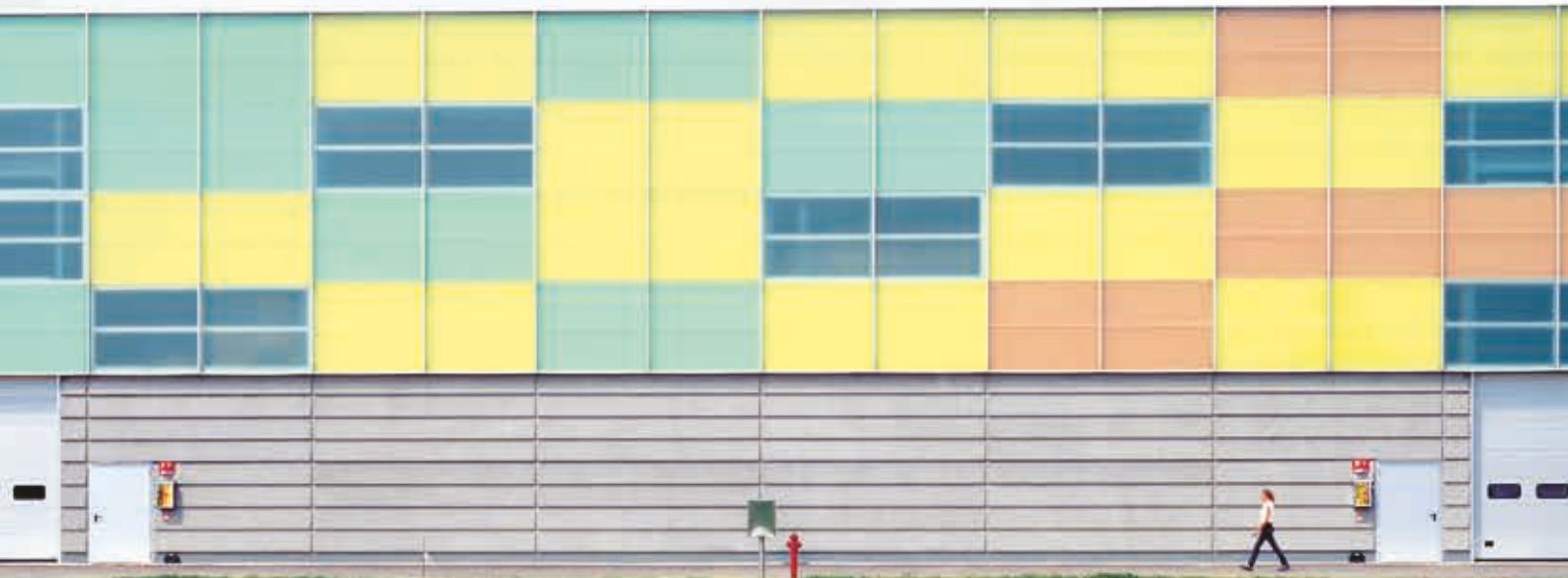

# Green & Human

The respect for the environment and for the people is a relevant issue for Sambonet Paderno Industrie S.p.A. Corporate Responsibility. The commitment to sustainable growth on which the Group was founded has been maintained and permits both to guarantee adequate working conditions in order to satisfy the changing needs of the staff and to apply solutions aimed at reducing the environmental impact. From this perspective, the management of energy, electricity and water consumption focuses on:

- the use of electrical energy: clean, renewable and in harmony with the environment;
- the use of methane as the sole fuel source;
- the use of ground water for the manufacturing process, to be fully purified before being released into the environment;
- the use of an advanced energy-saving technology.

## Sustainability Report

Sambonet Paderno Industrie S.p.A. strives to implement forms of measurement to assess the punctuality, the transparency and the efforts made for sustainable development. This has led to the preparation of the corporate charter of principles, 10 principles, 10 commitments, on which the Company builds its industrial future from a perspective based on preventive approach and stewardship.

### Corporate Sustainability Report

[corporate.sambonet.it/csr.html](http://corporate.sambonet.it/csr.html)

The **UNI EN ISO 14001:2004** environmental certification is the recognition that the environmental policy results in a continuous improvement of environmental performance by minimising the negative impact of its operations on the environment.

The voluntary compliance with the standard **UNI EN ISO 50001:2011** demonstrates the company's commitment and vision towards responsible energy consumption, factoring in both the economic hope of reducing consumption and, above all, the desire to increase environmental awareness about reducing greenhouse gas emissions.

The **OHSAS 18001:2007** safety certification has the objective of protecting the safety of the workplace and the health of workers. Sambonet Paderno Industrie S.p.A. is the first Italian company in its sector that has obtained this certification.

## Social Responsibility

Sustainability, transparency and interaction with stakeholders are the integral components that the Corporate Social Responsibility policy of Sambonet Paderno Industries S.p.A. are comprised of.

The company's requirements, commitment and path taken in this area led it to obtain an SR10 certification in 2016 - the first in the sector. This important goal represents an objective guarantee in terms of attention in the interaction with stakeholders such as employees, customers, suppliers, local communities and associations in the area.

## WHP Health Promoting Workplace

This socially responsible role has recently prompted the company to join the European Network for Health Promoting Workplace (WHP), establishing itself as one of the pioneers of its territory. The project foresees that the company not only implements all the measures to prevent accidents and illnesses in the workplace but - and above all - that it also undertakes to offer its workers opportunities to improve their health, through the promotion of a wholesome lifestyle mentally, physically and emotionally.

Il rispetto dell'ambiente e della persona sono temi rilevanti all'interno della responsabilità d'impresa di Sambonet Paderno Industrie S.p.A. Il Gruppo ha impostato e sviluppa tutt'oggi la propria evoluzione con un impegno di crescita sostenibile garantendo condizioni lavorative che possano soddisfare i bisogni delle persone nei differenti momenti della loro vita aziendale e applicando soluzioni volte a diminuire l'impronta ecologica. In quest'ottica, la gestione dei consumi energetici, elettrici e idrici è orientata a:

- impiegare energia elettrica pulita e rinnovabile;
- utilizzare il metano come unica fonte di combustibile;
- servirsi, per la produzione, di acqua di falda da restituire all'ambiente completamente depurata;
- usare tecnologia di risparmio energetico avanzata.

Sambonet Paderno Industrie S.p.A. lavora per attuare forme di misurazione che siano in grado di documentare la puntualità, la trasparenza e l'impegno messo in atto per uno sviluppo sostenibile. Da qui la creazione della propria carta dei principi, 10 principi, 10 impegni su cui, attraverso un approccio preventivo e una gestione responsabile, l'Azienda costruisce il proprio futuro industriale.

### Bilancio di Sostenibilità dell'Azienda

[corporate.sambonet.it/csr.html](http://corporate.sambonet.it/csr.html)

**UNI EN ISO 14001:2004** La certificazione ambientale garantisce i risultati di una politica ambientale volta al continuo miglioramento delle proprie performance minimizzando ogni impatto negativo delle sue attività verso l'ambiente.

**UNI EN ISO 50001:2011** L'adesione volontaria alla norma UNI EN ISO 50001:2011 testimonia l'impegno e la visione dell'azienda verso l'ottimizzazione del consumo responsabile dell'energia, sia in termini economici auspicando a una riduzione dei consumi, e soprattutto verso una crescente attenzione ambientale diminuendo le emissioni di gas serra.

**OHSAS 18001:2007** La certificazione ha l'obiettivo di tutelare la sicurezza e la salute dei propri lavoratori e dell'ambiente lavorativo. Sambonet Paderno Industrie S.p.A. è la prima Azienda appartenente al settore metalmeccanico ad ottenere l'attestazione.

Sostenibilità, trasparenza e interazione con gli stakeholder sono le parole chiave della politica di Corporate Social Responsibility di Sambonet Paderno Industrie S.p.A..

I requisiti, l'impegno e il percorso intrapreso dall'azienda in questo ambito, l'ha portata nel 2016 - prima nel settore - a conseguire la certificazione SR10. Questo importante traguardo rappresenta una garanzia oggettiva in fatto di attenzione nell'interazione con gli stakeholder quali dipendenti, clienti, fornitori, comunità locali e associazioni sul territorio.

Questo ruolo socialmente responsabile ha recentemente spinto l'impresa ad aderire alla Rete Europea WHP (European Network for Health Promoting Workplace) affermandosi tra le pioniere del proprio territorio. Il progetto prevede che l'azienda non solo attui tutte le misure per prevenire infortuni e malattie sul luogo di lavoro ma - e soprattutto - che si impegni anche a offrire ai propri lavoratori opportunità per migliorare la propria salute, attraverso la promozione di uno stile di vita corretto in ambito alimentare, sportivo ed emotivo.

# Certifications

## UNI EN ISO 22000

Sambonet Paderno Industrie is the first company in its industry that has been awarded the EN UNI ISO 22000:2005 certification. This certification attests to the highest international standard both for the Group and for the whole food and beverage industry. The implementation of its requirements, along with the implementation of HACCP (Hazard Analysis and Critical Control Points, a hygiene system that prevents contamination hazards), ensures the provision of a safe and impeccable service to customers by meticulously and scrupulously assessing the hygienic and safety conditions of activities and products. This is a guarantee not only for HoReCa professionals, but also, and foremost, for final consumers.

## UNI EN ISO 9001:2015

This quality certification ensures compliance with the requirements of the international UNI EN ISO 9001:2008 standard, which guarantees the production and sale of products that fully meet customers' needs and expectations.

## NSF

Some products by Sambonet Paderno Industrie S.p.A. have obtained the prestigious NSF (National Sanitation Foundation) certification for compliance with the strict standards applied in the USA to materials in contact with foodstuffs. The NSF mark is a guarantee for manufacturers, inspectors and users.

## AEO

In 2008 Sambonet Paderno Industrie S.p.A. obtained the AEO Certification for Customs Simplifications and Security and Safety, valid for the EU. This programme provides a framework for governing customs regulations, guaranteeing that the company provides a reliable and secure service within the international supply chain. In addition, in 2011, Sambonet Paderno Industrie S.p.A. obtained the mutual recognition of the AEO programme with the Japanese customs administration, thus further improving customs relations with Japan.

## KNOWN CONSIGNOR

The "Known Consignor" approval issued by ENAC (Italian Civil Aviation Authority) certifies that the company is an originator of cargo suitable for carriage on any aircraft, in compliance with common safety procedures and provisions.

## ECCELLENZA 2006

This prestigious certificate of Excellence, awarded by Certiquality to Sambonet Paderno Industrie S.p.A. for the implementation of an integrated Quality, Environmental and Safety management system, has been granted only to few companies in Italy that have obtained the ISO 9001, ISO 14001 and BS OHSAS 18001 certifications.

## AWARD FOR EXCELLENCE

In 2006 Sambonet Paderno Industrie S.p.A. received the Award for Excellence for Innovation by Confindustria (the main organization representing Italian manufacturing and services companies) with reference to the framework for innovation of the EFQM—European Foundation for Quality Management.

## UNI EN ISO 22000

Prima nel suo settore Sambonet Paderno Industrie S.p.A. ha ottenuto la certificazione EN UNI ISO 22000:2005. Così come per l'intero comparto food and beverage, anche per il Gruppo la UNI EN ISO 22000:2005 rappresenta lo standard di più alto livello su scala internazionale. L'applicazione dei suoi requisiti, congiuntamente all'applicazione dell'HACCP (Hazard Analysis and Critical Control Points, sistema di autocontrollo igienico che previene i pericoli di contaminazione), garantisce alla clientela un servizio sicuro ed impeccabile attraverso una valutazione puntuale e scrupolosa delle condizioni igieniche e sanitarie delle attività e dei prodotti. Una garanzia di tutela non solo per il personale del canale professionale ma anche, e soprattutto, per il consumatore finale.

## UNI EN ISO 9001:2015

La certificazione di qualità conforme ai requisiti della normativa internazionale garantisce la produzione e la commercializzazione di prodotti che soddisfino pienamente i requisiti e le aspettative del cliente.

## NSF

La certificazione è stata conseguita per alcuni prodotti grazie al superamento delle rigorose norme applicate negli USA circa i materiali a contatto con gli alimenti. Il marchio NSF (National Sanitation Foundation) è sinonimo di garanzia per i costruttori, ispettori ed utilizzatori.

## AEO

La certificazione comunitaria AEO Semplificazioni doganali e Sicurezza, conseguita nel 2008, garantisce un'attività disciplinata della regolamentazione doganale dell'azienda qualificandola in fatto di affidabilità e sicurezza nella catena di approvvigionamento internazionale. Nel 2011, inoltre, Sambonet Paderno Industrie S.p.A. ha ottenuto il mutuo riconoscimento del programma AEO con l'amministrazione doganale giapponese, condizione che favorisce ulteriormente i rapporti con il paese.

## MITTENTE CONOSCIUTO

L'approvazione "Mittente Conosciuto" rilasciata da ENAC (Ente Nazionale Aviazione Civile) riconosce l'Azienda come sito d'origine di merce idonea al trasporto su aeromobili di qualsiasi tipo, in conformità alle procedure e disposizioni comuni di sicurezza.

## ECCELLENZA 2006

Certiquality ha attribuito a Sambonet Paderno Industrie S.p.A. il Certificato di Eccellenza per aver implementato un sistema di gestione integrata di Qualità, Ambiente e Sicurezza. L'ambito riconoscimento è ottenuto da poche aziende in Italia certificate ISO 9001, ISO 14001 e BS OHSAS 18001.

## AWARD FOR EXCELLENCE

Nel 2006 Sambonet Paderno Industrie S.p.A. è stata insignita dell'Award for Excellence per l'innovazione, rilasciato da Confindustria in riferimento al framework per l'innovazione dell'EFQM—European Foundation for Quality Management.



# ASEC<sup>LAB</sup>

ALIMENTARY  
SECURITY  
CONTROL  
LABORATORY



ASECLAB1@SAMBONET.IT



LABORATORIO DI ANALISI  
INTERNO CERTIFICATO



LAB N°1407

The items produced and sold by Sambonet Paderno Industrie S.p.A. not only comply with applicable regulations, but are also systematically tested. The Company can guarantee the suitability and safety of its products as it has established a specific workgroup and the ASEC Lab (Alimentary Security Control) internal laboratory, which analyses the materials intended to come into contact with foodstuffs. The laboratory is now accredited to carry out migration testing on steel, aluminum, porcelain, glass, entirely plastic materials and coloring in order to issue declarations of compliance, recognized by both national and international governments. The ASEC Lab is also accredited to determine pH levels, solvents and metals in water discharge, a guarantee for the internal analysis of the wastewater quality.

Oltre alla conformità rispetto alle norme vigenti, gli articoli prodotti e commercializzati da Sambonet Paderno Industrie S.p.A. sono controllati in maniera sistematica. Grazie alla costituzione di un gruppo di lavoro e del laboratorio interno ASEC Lab (Alimentary Security Control), specializzato nell'analisi di materiali destinati al contatto con gli alimenti, l'Azienda è in grado di garantire l'idoneità e la sicurezza dei propri prodotti. Il laboratorio è oggi accreditato per realizzare internamente test di migrazione su acciaio, alluminio, porcellana, vetro, materiali plastici e coloranti per il rilascio di dichiarazioni di conformità, riconosciute da qualsiasi ente nazionale e internazionale. ASEC Lab è inoltre accreditato per la determinazione di pH, solventi e metalli nelle acque scarico, una garanzia per le analisi interne sulla qualità delle proprie acque di scarico.



Pentolame  
Cookware, pots & pans  
Kochgeschirr  
Batteries de cuisine  
Baterías de cocina

## 10



GN food pans  
Contentori GN  
GN-Behälter  
Bacs GN  
Cubetas GN

## 51



Kitchen utensils  
Utensili da cucina  
Küchenzubehöre  
Ustensiles de cuisine  
Utensilios de cocina

## 78



Knives  
Coltelleria  
Kochmesser  
Coutellerie  
Cuchilleria

## 137



Pastry utensils  
Pasticceria  
Konditorei-Artikel  
La pâtisserie  
Pastelería

## 170



Ethnic cuisine  
Cucina etnica  
Ethnische Küche  
Cuisine ethnique  
Cocina étnica

## 256





Bar & Ice-Cream  
Bar e gelateria  
Bar u. Eis-Artikel  
Bar et glace  
Bar y heladería

## 283



Table top service  
Tavola  
Tischservice  
Service de table  
Servicio de mesa

## 345



Buffet display and presentation  
Buffet e presentazione  
Buffet und Präsentation  
Buffet et présentation  
Presentación de buffet

## 393



Chafing dishes / Trolleys  
Scaldavivande / Carrelli sala  
Chafing dishes / Servicewagen  
Chafing dishes / Chariots  
Chafing dishes / Carros

## 436



Storage, transport, cleaning  
Stoccaggio, trasporto, pulizia  
Lagerung, Transport, Reinigung  
Stockage, transport, nettoyage  
Almacenamiento, transporte, limpieza

## 459

































Electric appliances  
Apparecchi elettrici  
Elektrogeräte  
Appareils électriques  
Aparatos eléctricos





















## 497



## ICONS - SIMBOLOGIA - SYMBOLE - SYMBOLES - ICONOS

 <b>ABS</b>	Copolymer, acrylonitrile-butadiene-styrene Copolimero, acrilonitrile-butadiene-stirene	 <b>PA+</b> <i>plus</i>	Polyamide (nylon 6.6) with fiberglass Poliammide (nylon 6.6) con fibra di vetro
 <b>AG</b>	Silverplated Argentato	 <b>PR</b>	Porcelain Porcellana
 <b>AQ</b> PVD	Antique PVD	 <b>PC</b>	Polycarbonate Policarbonato
 <b>AR</b>	Natural slate Ardesia naturale	 <b>PE</b>	Polyethylene Polietilene
 <b>AY</b>	Acrylic Acrilico	 <b>PMMA</b>	Polymethylmethacrylate, plexiglass Polimetilmetacrilato, plexiglas
 <b>B</b>	Bamboo	 <b>PPE</b>	Phenylene ether-expanded polypropylene Etere di polifenilene-polipropilene espanso
 <b>BC</b>	Bone china	 <b>PP</b>	Polypropylene Polipropilene
 <b>BPA</b> FREE	Without bisphenol A Senza bisfenolo A	 <b>PS</b>	Polystyrene Polistirene/polistirolo
 <b>FE</b>	Metal Metallo	 <b>PVD</b>	Physical vapor deposition Deposizione fisica da vapore
 <b>HDPE</b>	High-density polyethylene Polietilene ad alta densità	 <b>R</b>	Natural rattan Rattan naturale
 <b>MF</b>	Melamine Melamina	 <b>SAN</b>	Acrylonitrile-styrene copolymer Copolimero acrilonitrile-stirene
 <b>MS</b>	Methylstyrene Metilstirene	 <b>SS</b>	Stainless steel Acciaio inox
 <b>NEW</b>	New Novità	 <b>VG</b>	Vintage
 <b>NSF</b>	NSF certified Certificato NSF	 <b>VG</b> PVD	Vintage PVD
 <b>PA</b>	Polyamide (nylon) Poliammide (nylon)	 <b>W</b>	Wood Legno

# ICONS - SIMBOLOGIA - SYMBOLE - SYMBOLES - ICONOS

	Suitable for electric stoves Adatto per fornelli elettrici		GN size Misure GN
	Suitable for glass-ceramic stoves Adatto per fornelli in vitroceramica		Battery powered Alimentato a batterie
	Suitable for induction stoves Adatto per fornelli a induzione		Hand wash Lavare a mano
	Suitable for gas stoves Adatto per fornelli a gas		Do not use sharp objects Non usare oggetti taglienti
	For gluten free food Per alimenti senza glutine		Do not use on open flames Non utilizzare su fiamme libere
	Cooling Refrigerabile		Dishwasher safe Lavabile in lavastoviglie
	Heated Riscaldato		No dishwasher safe Non lavabile in lavastoviglie
	Water resistant Resistente all'acqua		Microwave safe Idoneo a microonde
	NO water resistant NON resistente all'acqua		Oven safe Idoneo a forno
	With light Con luce		No microwave safe Non idoneo a microonde
	Food safe Per alimenti		No oven safe Non idoneo a forno
	Stackable Impilabile		

Product list # Gluten Free - Spare parts  
Elenco prodotti Gluten Free - Ricambi  
Glutenfrei-Produktliste - Ersatzteile  
Liste produits Gluten Free - Pièces de rechange  
Lista productos Gluten Free - Repuestos

## 521



Index and sales terms  
Indice e condizioni di vendita  
Index und Verkaufsbedingungen  
Index et conditions de vente  
Índice y condiciones de venta

## 534





# SERIES 1100

STAINLESS STEEL COOKWARE  
PENTOLAME INOX



Outside and inside satin polished. Top edges mirror polished. Hollow tubular stay cool handles in stainless steel, ergonomically shaped. Extra thick edges. Double thick bottom. Sandwich thermoradiant bottom (stainless steel-aluminum-stainless steel). Concave bottom when cold and flat when hot (100% heat exploiting). Perfect for use on any type of stove, whether gas, electric, glass ceramic cooking surface or induction stove. All items have an induction suited sandwich bottom.

Finitura esterna ed interna satinata, bordo lucido. Manicatura tubolare in acciaio inox, anatomica, resistente al calore. Bordo rinforzato. Doppio spessore del fondo. Fondo termodiffusore sandwich (inox-alluminio-inox). Concavo a freddo e piano a caldo (sfruttamento del calore al 100%). Ideali per ogni tipo di cottura, gas, elettrica, vetroceramica e induzione. Tutti gli articoli sono dotati di speciale fondo termodiffusore adatto anche per piastre ad induzione.



**Stock pot**  
Pentola  
Hoher Suppentopf  
Marmite traiteur  
Olla recta

art.	Ø cm.	h.	lt.
11101-16	16	16	3,2
11101-20	20	20	6,2
11101-24	24	24	10,0
11101-28	28	28	16,5
11101-32	32	32	24,0
11101-36	36	36	36,0
11101-40	40	40	50,0
11101-45	45	45	70,0
11101-50	50	50	100,0



**Low stock pot**  
Pentola bassa  
Gemüsetopf  
Faitout  
Olla recta baja

art.	Ø cm.	h.	lt.
11105-16	16	14	2,7
11105-20	20	17	5,0
11105-24	24	21	8,5
11105-28	28	23	14,5
11105-32	32	26	22,0
11105-36	36	28	29,0
11105-40	40	32	40,0



**Saucepot**  
Casseruola alta  
Fleischtopf  
Brasière  
Cacerola alta

art.	Ø cm.	h.	lt.
11107-16	16	11,0	2,1
11107-20	20	13,0	4,0
11107-24	24	15,0	6,5
11107-28	28	17,5	10,8
11107-32	32	19,5	15,7
11107-36	36	21,5	22,0
11107-40	40	24,5	30,8
11107-45	45	27,5	44,0
11107-50	50	32,0	63,0



**Casserole pot**  
Casseruola bassa  
Bratentopf  
Sautoir  
Cacerola baja

art.	Ø cm.	h.	lt.
11109-16	16	7,5	1,3
11109-20	20	8,0	2,5
11109-24	24	9,5	4,3
11109-28	28	11,0	6,7
11109-32	32	12,5	10,0
11109-36	36	14,0	14,2
11109-40	40	15,5	19,5
11109-45	45	17,0	27,0
11109-50	50	19,0	37,0



**Colander for stock pot**  
Colapasta per pentola  
Seiher für Suppentopf  
Passoire pour marmite  
Colador para olla recta

art.	Ø cm.	h.
11123-20	20	22,0
11123-24	24	26,5
11123-28	28	29,5

**Suitable for both item 11105 and 11101.**  
Per art. 11105 e art. 11101.



**Stock pot with tap**  
Pentola con rubinetto  
Hochtopf mit Hahn  
Marmite avec robinet  
Olla con grifo

art.	Ø cm.	h.	lt.
11102-28	28	28	16,5
11102-32	32	32	24,0
11102-36	36	36	36,0
11102-40	40	40	50,0
11102-45	45	45	70,0
11102-50	50	50	100,0



**Steamer pot, perforated bottom**  
Inserto a vapore, fondo forato  
Dampf-Siebeinsatz  
Casserole à vapeur, perforée  
Cacerola base perforada

art.	Ø cm.	h.
11119-20	20	12,5
11119-24	24	15,0
11119-28	28	17,0
11119-32	32	19,0



**Saucepan**  
Casseruola alta  
Stielkasserolle, hoch  
Casserole haute  
Cazo recto alto

art.	Ø cm.	h.	lt.
11106-14	14	8,0	1,2
11106-16	16	11,0	2,1
11106-20	20	13,0	4,0
11106-24	24	15,0	6,5
11106-28*	28	17,5	10,8
11106-32*	32	19,5	15,7
11106-36*	36	21,5	22,0

\*With loop handle. – Con contromaniglia.



**Sauté pan**

Casseruola bassa  
Stielkasserolle, niedrig  
Plat à sauter

**Cazo recto bajo**

art.	Ø cm.	h.	lt.
11108-16	16	6,5	1,3
11108-20	20	8,0	2,5
11108-24	24	9,5	4,3
11108-28*	28	11,0	6,7
11108-32*	32	12,5	10,0
11108-36*	36	14,0	14,2

\*With loop handle. – Con contromaniglia.



**Sauté pan**

Casseruola conica  
Sauteuse  
Sauteuse

**Cazo cónico**

art.	Ø cm.	h.	lt.
11112-16	16	6,0	1,0
11112-18	18	6,0	1,2
11112-20	20	6,5	1,6
11112-24	24	7,5	2,7



**Curved sauté pan**

Casseruola "bombé"  
Sauteuse mit Schüttrand  
Sauteuse bombé

**Cazo bombeado**

art.	Ø cm.	h.	lt.
11113-18	18	7,0	1,7
11113-20	20	7,5	2,2
11113-24	24	8,5	3,3
11113-26	26	9,0	4,2



**Frypan**

Padella  
Bratpfanne  
Poêle à frire  
Sartén

art.	Ø cm.	h.
11114-20	20	5,0
11114-24	24	5,0
11114-28	28	5,5
11114-32	32	6,0
11114-36*	36	6,0
11114-40*	40	6,0
11114-45*	45	6,5

\*With loop handle. – Con contromaniglia.



**Frypan, non stick coating**

Padella, antiaderente  
Bratpfanne mit Antihafbeschichtung  
Poêle avec revêtement anti-adhésif  
Sartén antiaderente

art.	Ø cm.	h.
11117-20	20	5,0
11117-24	24	5,0
11117-28	28	5,5
11117-32	32	6,0
11117-36	36	6,0
11117-40	40	6,0



**French omelet pan**

Tegame  
Servierpfanne  
Poêle à paella  
Paellera

art.	Ø cm.	h.
11115-20	20	5,0
11115-24	24	5,0
11115-28	28	5,5
11115-32	32	6,0
11115-36	36	6,0
11115-40	40	6,0
11115-45	45	6,5
11115-50	50	8,0



**Cover, reinforced edge**

Coperchio, bordo rinforzato  
Deckel mit Randverstärkung  
Couvercle, bord renforcé  
Tapa, borde reforzado

art.	Ø cm.
11161-12	12
11161-14	14
11161-16	16
11161-18	18
11161-20	20
11161-22	22
11161-24	24
11161-28	28
11161-32	32
11161-36	36
11161-40	40
11161-45	45
11161-50	50
11161-60	60





# SERIES 2100

STAINLESS STEEL COOKWARE  
PENTOLAME INOX



The serie 2100 has the same characteristics of the serie 1100. It varies only for the shape of the handles of 2 handles items. Perfect for use on any type of stove, whether gas, electric, glass ceramic cooking surface or induction stove. All items have an induction suited sandwich bottom.

La serie 2100 ha le stesse caratteristiche della serie 1100. Differisce solo per una diversa manicatura sugli articoli a 2 maniglie. Ideali per ogni tipo di cottura, gas, elettrica, vetroceramica e induzione. Tutti gli articoli sono dotati di speciale fondo termodiffusore adatto anche per piastre ad induzione.



**Stock pot**  
Pentola  
Hoher Suppentopf  
Marmite traiteur  
Olla recta

art.	Ø cm.	h.	lt.
12101-16	16	16	3,2
12101-20	20	20	6,2
12101-24	24	24	10,0
12101-28	28	28	16,5
12101-32	32	32	24,0
12101-36	36	36	36,0
12101-40	40	40	50,0
12101-45	45	45	70,0
12101-50	50	50	100,0



**Saucepot**  
Casseruola alta  
Fleischtopf  
Brasière  
Cacerola alta

art.	Ø cm.	h.	lt.
12107-16	16	11,0	2,1
12107-20	20	13,0	4,0
12107-24	24	15,0	6,5
12107-28	28	17,5	10,8
12107-32	32	19,5	15,7
12107-36	36	21,5	22,0
12107-40	40	24,5	30,8
12107-45	45	27,5	44,0
12107-50	50	32,0	63,0



**Casserole pot**  
Casseruola bassa  
Bratentopf  
Sautoir  
Cacerola baja

art.	Ø cm.	h.	lt.
12109-16	16	7,5	1,3
12109-20	20	8,0	2,5
12109-24	24	9,5	4,3
12109-28	28	11,0	6,7
12109-32	32	12,5	10,0
12109-36	36	14,0	14,2
12109-40	40	15,5	19,5
12109-45	45	17,0	27,0
12109-50	50	19,0	37,0



# SERIES 1000

STAINLESS STEEL COOKWARE  
PENTOLAME INOX



Outside and inside satin polished. Non-drip edge. Hollow tubular stay cool handles in stainless steel, ergonomically shaped. Uniform thickness in sides and bottoms. Sandwich thermoradiant bottom (stainless steel-aluminum-stainless steel). Concave bottom when cold and flat when hot (100% heat exploiting). Perfect for use on any type of stove, whether gas, electric, glass ceramic cooking surface or induction stove. All items have an induction suited sandwich bottom.

Finitura esterna ed interna satinata. Bordo a versare. Manicatura tubolare in acciaio inox, anatomica, resistente al calore. Parete e fondo a spessore uniforme. Fondo termodiffusore sandwich (inox-alluminio-inox). Concavo a freddo e piano a caldo (sfruttamento del calore al 100%). Ideali per ogni tipo di cottura, gas, elettrica, vetroceramica e induzione. Tutti gli articoli sono dotati di speciale fondo termodiffusore adatto anche per piastre ad induzione.





**Stock pot**

Pentola  
Hoher Suppentopf  
Marmite traiteur  
Olla recta

art.	Ø cm.	h.	lt.
11001-16	16	16,0	3,2
11001-18	18	16,0	4,0
11001-20	20	18,0	5,5
11001-22	22	22,0	8,3
11001-24	24	24,0	10,5
11001-28	28	28,0	17,0
11001-32	32	27,5	20,4
11001-36	36	36,0	36,5
11001-40	40	40,0	50,0
11001-45	45	40,0	63,5
11001-50	50	50,0	98,0
11001-60	60	55,0	150,0



**Saucepot**

Casseruola alta  
Fleischtopf  
Brasière  
Cacerola alta

art.	Ø cm.	h.	lt.
11007-16	16	9,5	1,9
11007-18	18	10,8	2,7
11007-20	20	12,0	3,8
11007-22	22	13,0	5,0
11007-24	24	14,5	6,5
11007-28	28	16,0	9,8
11007-32	32	19,5	15,4
11007-36	36	21,5	20,5
11007-40	40	24,0	30,1
11007-45	45	27,0	42,9
11007-50	50	30,0	58,0
11007-60	60	35,0	99,0



**Casserole pot**

Casseruola bassa  
Bratentopf  
Sautoir  
Cacerola baja

art.	Ø cm.	h.	lt.
11009-16	16	6,5	1,3
11009-18	18	7,0	1,8
11009-20	20	7,5	2,5
11009-24	24	8,0	3,7
11009-28	28	9,5	5,8
11009-32	32	11,0	9,2
11009-36	36	13,0	13,0
11009-40	40	14,5	18,0
11009-45	45	15,5	24,6
11009-50	50	19,0	37,0
11009-60	60	25,0	70,7



**Saucepan**

Casseruola mezza alta  
Bratentopf, mittelhoch  
Casserole  
Cacerola francés

art.	Ø cm.	h.	lt.
11010-16	16	8	1,6
11010-18	18	9	2,3
11010-20	20	10	3,1
11010-24	24	12	5,4



**Sauté pan**

Casseruola conica  
Sauteuse  
Sauteuse  
Cazo cónico

art.	Ø cm.	h.	lt.
11012-16	16	6,0	1,0
11012-18	18	6,0	1,2
11012-20	20	6,5	1,6
11012-24	24	7,5	2,7



**Curved sauté pan**

Casseruola bombé  
Sauteuse mit Schüttrand  
Sauteuse bombé  
Cazo bombeado

art.	Ø cm.	h.	lt.
11013-18	18	7,0	1,7
11013-20	20	7,5	2,2
11013-24	24	8,5	3,3
11013-26	26	9,0	4,2





**Saucepan**

Casseruola alta  
Stielkasserolle, hoch  
Casserole haute  
Cazo recto alto

art.	Ø cm.	h.	lt.
11006-12	12	7,0	0,8
11006-14	14	8,0	1,2
11006-16	16	9,5	1,9
11006-18	18	10,8	2,7
11006-20	20	12,0	3,8
11006-22	22	13,0	5,0
11006-24	24	14,5	6,5
11006-28*	28	16,0	9,8
11006-32*	32	19,5	15,4
11006-36*	36	21,5	20,5

\*With loop handle. – Con contromaniglia.



**Saucepan**

Casseruola mezza alta  
Stielkasserolle, mittelhoch  
Casserole  
Cazo recto francés

art.	Ø cm.	h.	lt.
11011-16	16	8	1,6
11011-18	18	9	2,3
11011-20	20	10	3,1
11011-24	24	12	5,4



**Sauté pan**

Casseruola bassa  
Stielkasserolle, niedrig  
Plat à sauter  
Cazo recto bajo

art.	Ø cm.	h.	lt.
11008-16	16	6,5	1,3
11008-18	18	7,0	1,8
11008-20	20	7,5	2,5
11008-24	24	8,0	3,7
11008-28*	28	9,5	5,8
11008-32*	32	11,0	9,2
11008-36*	36	13,0	13,0

\*With loop handle. – Con contromaniglia.



**Frypan**

Padella  
Bratpfanne  
Poêle à frire  
Sartén

art.	Ø cm.	h.
11014-20	20	5,0
11014-24	24	5,0
11014-28	28	5,5
11014-32	32	6,0
11014-36*	36	6,0
11014-40*	40	6,0
11114-45*	45	6,5

\*With loop handle. – Con contromaniglia.



**Frypan, non stick**

Padella, antiaderente  
Bratpfanne, nichttaftend  
Poêle, anti-adhérente  
Sartén antiadherente

art.	Ø cm.	h.
11117-20	20	5,0
11117-24	24	5,0
11117-28	28	5,5
11117-32	32	6,0
11117-36	36	6,0
11117-40	40	6,0



**French omelet pan**

Tegame  
Servierpfanne  
Poêle à paella  
Paellera

art.	Ø cm.	h.
11115-20	20	5,0
11115-24	24	5,0
11115-28	28	5,5
11115-32	32	6,0
11115-36	36	6,0
11115-40	40	6,0
11115-45	45	6,5
11115-50	50	8,0



**Cover**

Coperchio  
Deckel  
Couvercle  
Tapa

art.	Ø cm.
11061-12	12
11061-16	16
11061-18	18
11061-20	20
11061-22	22
11061-24	24
11061-28	28
11061-32	32
11061-36	36
11061-40	40
11061-45	45
11061-50	50
11161-60	60





# SERIES 2000

STAINLESS STEEL COOKWARE  
PENTOLAME INOX



The serie 2000 has the same characteristics of the serie 1000. It varies only for the shape of the handles of 2 handles items. Perfect for use on any type of stove, whether gas, electric, glass ceramic cooking surface or induction stove. All items have an induction suited sandwich bottom.

La serie 2000 ha le stesse caratteristiche della serie 1000. Differisce solo per una diversa manicatura sugli articoli a 2 maniglie. Ideali per ogni tipo di cottura, gas, elettrica, vetroceramica e induzione. Tutti gli articoli sono dotati di speciale fondo termodiffusore adatto anche per piastre ad induzione.



**Stock pot**

Pentola  
Hoher Suppentopf  
Marmite traiteur  
Olla recta

art.	Ø cm.	h.	lt.
12001-16	16	16,0	3,2
12001-18	18	16,0	4,0
12001-20	20	18,0	5,5
12001-22	22	22,0	8,3
12001-24	24	24,0	10,5
12001-28	28	28,0	17,0
12001-32	32	27,5	20,4
12001-36	36	36,0	36,5
12001-40	40	40,0	50,0
12001-45	45	40,0	63,5
12001-50	50	50,0	98,0
12001-60	60	55,0	150,0



**Saucepot**

Casseruola alta  
Fleischtopf  
Brasière  
Cacerola alta

art.	Ø cm.	h.	lt.
12007-16	16	9,5	1,9
12007-18	18	10,8	2,7
12007-20	20	12,0	3,8
12007-22	22	13,0	5,0
12007-24	24	14,5	6,5
12007-28	28	16,0	9,8
12007-32	32	19,5	15,4
12007-36	36	21,5	20,5
12007-40	40	24,0	30,1
12007-45	45	27,0	42,9
12007-50	50	30,0	58,0
12007-60	60	35,0	99,0



**Casserole pot**

Casseruola bassa  
Bratentopf  
Sautoir  
Cacerola baja

art.	Ø cm.	h.	lt.
12009-16	16	6,5	1,3
12009-18	18	7,0	1,8
12009-20	20	7,5	2,5
12009-24	24	8,0	3,7
12009-28	28	9,5	5,8
12009-32	32	11,0	9,2
12009-36	36	13,0	13,0
12009-40	40	14,5	18,0
12009-45	45	15,5	24,6
12009-50	50	19,0	37,0
12009-60	60	25,0	70,7



**Sauté pan**

Casseruola conica  
Sauteuse  
Sauteuse  
Cazo cónico

art.	Ø cm.	h.	lt.
11012-16	16	6,0	1,0
11012-18	18	6,0	1,2
11012-20	20	6,5	1,6
11012-24	24	7,5	2,7



**Curved sauté pan**

Casseruola bombé  
Sauteuse mit Schüttrand  
Sauteuse bombé  
Cazo bombeado

art.	Ø cm.	h.	lt.
11013-18	18	7,0	1,7
11013-20	20	7,5	2,2
11013-24	24	8,5	3,3
11013-26	26	9,0	4,2



**Saucepan**

Casseruola mezza alta  
Stielkasserolle, mittelhoch  
Casserole  
Cazo recto francés

art.	Ø cm.	h.	lt.
11011-16	16	8,0	1,6
11011-18	18	9,0	2,3
11011-20	20	10,0	3,1
11011-24	24	12,0	5,4



**Asparagus-pot with lid**

Pentola cuociasparagi con coperchio  
Spargeltopf mit Deckel  
Cuit-asperges avec couvercle  
Olla espárragos con tapa

art.	Ø cm.	h.	lt.
12037-16	16	24,0	4,8



**Steamer pot, perforated bottom**

Inserto a vapore, fondo forato  
Dampf-Siebeinsatz  
Casserole à vapeur, perforée  
Cacerola base perforada

art.	Ø cm.	h.
12119-20	20	12,5
12119-24	24	15,0
12119-28	28	17,0
12119-32	32	19,0



**Saucepan**

Casseruola alta  
Stielkasserolle, hoch  
Casserole haute  
Cazo recto alto

art.	Ø cm.	h.	lt.
11006-12	12	7,0	0,8
11006-14	14	8,0	1,2
11006-16	16	9,5	1,9
11006-18	18	10,8	2,7
11006-20	20	12,0	3,8
11006-22	22	13,0	5,0
11006-24	24	14,5	6,5
11006-28*	28	16,0	9,8
11006-32*	32	19,5	15,4
11006-36*	36	21,5	20,5

\*With loop handle. – Con contromaniglia.



**Sauté pan**

Casseruola bassa  
Stielkasserolle, niedrig  
Plat à sauter  
Cazo recto bajo

art.	Ø cm.	h.	lt.
11008-16	16	6,5	1,3
11008-18	18	7,0	1,8
11008-20	20	7,5	2,5
11008-24	24	8,0	3,7
11008-28*	28	9,5	5,8
11008-32*	32	11,0	9,2
11008-36*	36	13,0	13,0

\*With loop handle. – Con contromaniglia.



**Frypan**

Padella  
Bratpfanne  
Poêle à frire  
Sartén

art.	Ø cm.	h.
11014-20	20	5,0
11014-24	24	5,0
11014-28	28	5,5
11014-32	32	6,0
11014-36*	36	6,0
11014-40*	40	6,0
11114-45*	45	6,5

\*With loop handle. – Con contromaniglia.



**Frypan, non stick**

Padella, antiaderente  
Bratpfanne, nichthaftend  
Poêle, anti-adhérente  
Sartén antiadherente

art.	Ø cm.	h.
11117-20	20	5,0
11117-24	24	5,0
11117-28	28	5,5
11117-32	32	6,0
11117-36	36	6,0
11117-40	40	6,0



**French omelet pan**

Tegame  
Servierpfanne  
Poêle à paella  
Paellera

art.	Ø cm.	h.
11115-20	20	5,0
11115-24	24	5,0
11115-28	28	5,5
11115-32	32	6,0
11115-36	36	6,0
11115-40	40	6,0
11115-45	45	6,5
11115-50	50	8,0



**Cover**

Coperchio  
Deckel  
Couvercle  
Tapa

art.	Ø cm.
11061-16	16
11061-18	18
11061-20	20
11061-22	22
11061-24	24
11061-28	28
11061-32	32
11061-36	36
11061-40	40
11061-45	45
11061-50	50
11161-60	60



# FOR GLUTEN-FREE COOKING



AL SERVIZIO DELLA CUCINA SENZA GLUTINE

FOR PRODUCT # LIST SEE PAGES FROM 521 TO 525  
PER L'ELENCO PRODOTTI VEDI PAGINE DA 521 A 525



Consistently with the functional approach, which has always marked the brand, Paderno offers a complete product line and professional tools, easily recognizable in the kitchen, which can reduce possible mistakes during their use to protect people affected by celiac disease. Developed and realized in 2013 in collaboration with Associazione Italiana Celiachia Lombardia ONLUS (Italian Society for the Celiac Disease – Lombardy Section), this project makes Sambonet Paderno Industrie S.p.A. the first company in its market that offers to the HoReCa channel a complete line of items intended for gluten-free cooking.

Some distinguished special features, such as golden PVD handles for pans and pots and a special customised logo for utensils, will allow professionals to easily identify all these items in the kitchen.

This product line aims at:

- Reducing the risk of accidental food cross-contamination;
- Making it easier for professionals to work and provide services to clients with food intolerances;
- Raising awareness on the gluten-free diet issue in the industry so as to respond to the new needs of consumers.

Coerentemente all'ottica di servizio che contraddistingue da sempre il marchio, Paderno propone una linea completa di articoli e strumenti professionali facilmente identificabili in cucina, in grado di abbattere eventuali errori durante il loro utilizzo a salvaguardia del cliente celiaco e di tutti gli intolleranti. Sviluppato e concretizzato nel 2013 in collaborazione con l'Associazione Italiana Celiachia Lombardia ONLUS, questo progetto colloca Sambonet Paderno Industrie come prima azienda del settore a offrire al canale Ho.Re.Ca una linea completa di articoli da destinare alla preparazione di pietanze senza glutine.

Attraverso alcuni elementi distintivi e differenzianti, come manici in PVD oro per pentole e padelle e personalizzazione con un logo specifico per utensili, tutti gli strumenti saranno facilmente identificabili in cucina.

Questa gamma contribuisce a:

- Diminuire il rischio di accidentali contaminazioni crociate degli alimenti;
- Facilitare il professionista nell'operare e nell'offrire un servizio a favore del cliente con intolleranze alimentari;
- Sensibilizzare il settore sul tema "gluten free" di fronte alle nuove esigenze dei consumatori.



# SERIES 2500 3-PLY

STAINLESS STEEL COOKWARE  
PENTOLAME INOX



Paderno serie 2500 3-ply is especially designed for professional kitchens, features super heat-conductive multi-layer construction that distributes heat from bottom to rim quickly and evenly. Outside and inside satin polished. Non-drip edge. Stainless steel handles, ergonomically shaped. Uniform thickness in sides and bottoms. Energy saving on all types of cookers. Suitable for all cooking ranges, induction hobs included. induzione.

La serie Paderno 2500 3-ply concepita per l'utilizzo nelle cucine professionali è costruita in materiale multistrato che assicura una distribuzione rapida ed uniforme del calore su tutta la superficie dell'utensile. Finitura esterna ed interna satinata. Bordo a versare. Manicatura anatomica in acciaio inox. Parete e fondo a spessore uniforme. Risparmio di energia su tutti i piani di cottura. Ideali per ogni tipo di cottura inclusa l'induzione.



**Saucepot**

Casseruola alta  
Fleischtopf  
Brasière  
Cacerola alta

art.	Ø cm.	h.	lt.
12507-24	24	11,5	5,0
12507-28	28	14,0	8,5



**Casserole pot**

Casseruola bassa  
Bratentopf  
Sautoir  
Cacerola baja

art.	Ø cm.	h.	lt.
12509-20	20	9,5	2,8
12509-24	24	10,5	4,7
12509-28	28	11,0	6,5



**Saucepan**

Casseruola mezza alta  
Stielkasserolle, mittelhoch  
Casserole  
Cazo recto francés

art.	Ø cm.	h.	lt.
12511-16	16	7,5	1,5
12511-18	18	8,0	2,0
12511-20	20	8,8	2,5
12511-24	24	10,5	4,6



**Sauté pan**

Casseruola bassa  
Stielkasserolle, niedrig  
Plat à sauter  
Cazo recto bajo

art.	Ø cm.	h.	lt.
12508-24	24	5,0	2,0



**Wok with grid and cover**

Wok c/griglia e coperchio  
Wok mit Rost und Deckel  
Wok avec grille et couvercle  
Wok con rejilla y tapa

art.	Ø cm.	h.
12529-32	32	8



**Curved sauté pan**

Casseruola bombé  
Sauteuse mit Schüttrand  
Sauteuse bombé  
Cazo bombeado

art.	Ø cm.	h.	lt.
12513-16	16	6,0	1,2
12513-18	18	6,5	1,6
12513-20	20	7,0	2,0
12513-24	24	8,5	3,8



**Frypan**

Padella  
Bratpfanne  
Poêle à frire  
Sartén

art.	Ø cm.	h.
12514-24	24	5,5
12514-26	26	5,5
12514-28	28	5,5
12514-32	32	4,0
12514-36	36	4,0



**Frypan, non stick coating**

Padella, antiaderente  
Bratpfanne mit Antihftbeschichtung  
Poêle avec revêtement anti-adhésif  
Sartén antiaderente

art.	Ø cm.	h.
12517-24	24	5,5
12517-26	26	5,5
12517-28	28	5,5
12517-32	32	5,5
12517-36	36	5,5





**Frypan**

Padella  
Bratpfanne  
Poêle à frire  
Sartén

art.	Ø cm.	h.
12514-20	20	3,0

**Mirror finishing.** – Finitura lucida.



**Saucepot with lid**

Casseruola alta, con coperchio  
Fleischtopf mit Deckel  
Brasière avec couvercle  
Cacerola alta con tapa

art.	Ø cm.	h.	lt.
12509-12	12	6	0,7

**Mirror finishing.** – Finitura lucida.



**Sauté pan with double spouts**

Casseruola bassa con doppio becco  
Stielkasserolle, niedrig, 2 Schnabel  
Plat à sauter, 2 becs  
Cazo recto bajo, 2 picos

art.	Ø cm.	h.	lt.
12511-10	10	5	0,4

**Mirror finishing.** – Finitura lucida.



**Sauté pan**

Casseruola bassa  
Stielkasserolle, niedrig  
Plat à sauter  
Cazo recto bajo

art.	Ø cm.	h.	lt.
12511-12	12	6	0,7
12511-14	14	7	1,0

**Mirror finishing.** – Finitura lucida.



**Cover**

Coperchio  
Deckel  
Couvercle  
Tapa

art.	Ø cm.
12561-12	12
12561-16	16
12561-18	18
12561-20	20
12561-24	24
12561-26	26
12561-28	28



**Cover**

Coperchio  
Deckel  
Couvercle  
Tapa

art.	Ø cm.
11061-12	12
11061-16	16
11061-18	18
11061-20	20
11061-24	24
11061-28	28





# MISCELLANEOUS COMPLEMENTI

STAINLESS STEEL COOKWARE  
PENTOLAME INOX

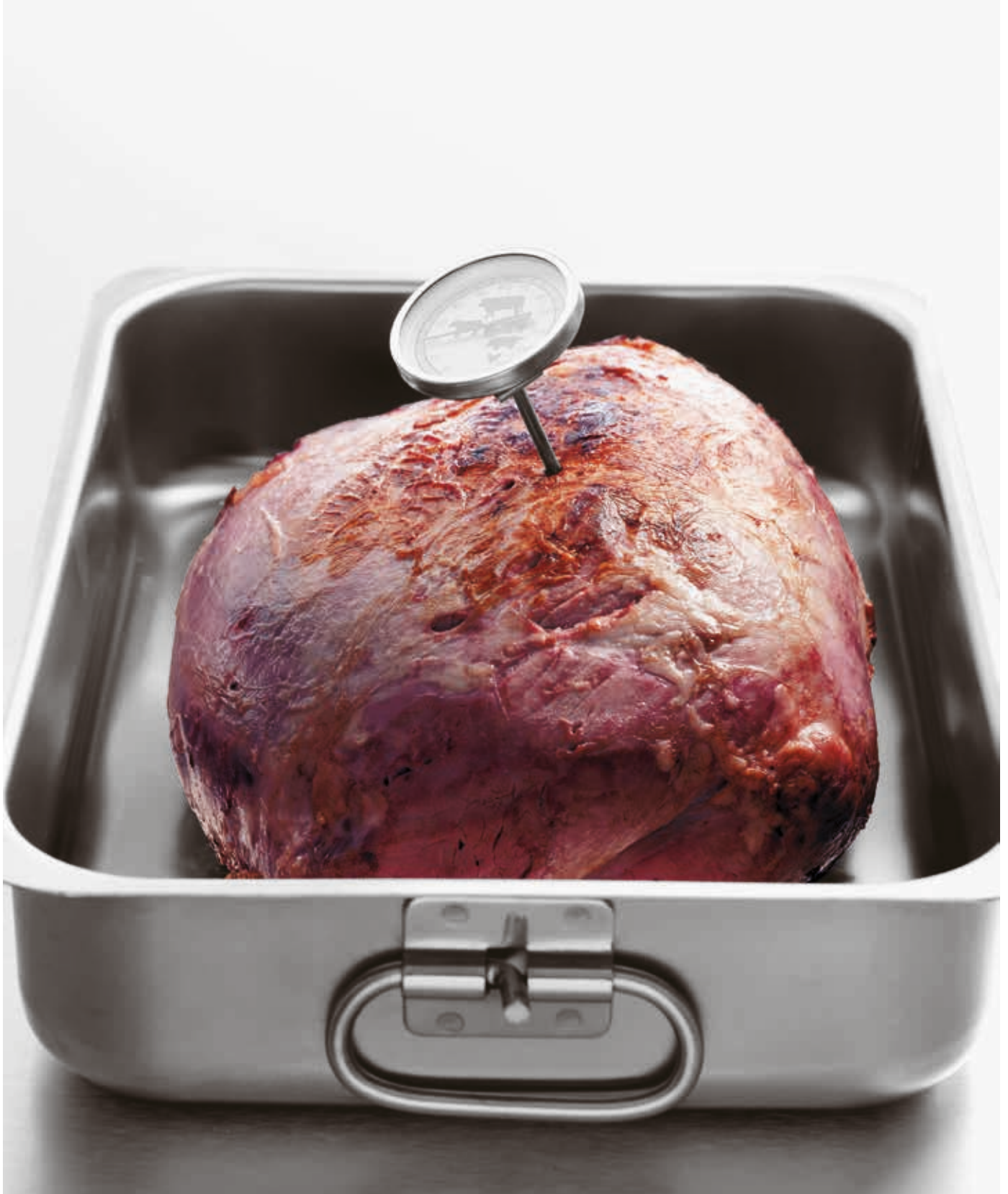



**Roasting pan**

Tegame  
Bräter  
Plaque à rôtir  
Rustidera

art.	cm.	h.
11941-35	35x25	8
11941-40	40x26	9
11941-45	45x30	9
11941-50	50x30	9
11941-60	60x35	9



**Heavy roasting pan**

Tegame pesante  
Bräter, Schwerausführung  
Plaque à rôtir lourde  
Rustidera pesada

art.	cm.	h.
11943-40	40x26	9
11943-45	45x30	9
11943-50	50x30	9
11943-60	60x35	9
11943-61*	61x43	9

\*For 2/1 GN ovens. – Per forno GN 2/1.



**Heavy roasting pan**

Tegame pesante  
Bräter, Schwerausführung  
Plaque à rôtir lourde  
Rustidera pesada

art.	cm.	h.
11944-40	40x26	9
11944-45	45x30	9
11944-50	50x30	9
11944-60	60x35	9
11944-61*	61x43	9

\*For 2/1 GN ovens. – Per forno GN 2/1.



**Lid**

Coperchio  
Deckel  
Couvercle  
Tapa

art.	cm.
11948-40	40x26
11948-45	45x30
11948-50	50x30
11948-60	60x35
11948-61*	61x43

\*For 2/1 GN ovens. – Per forno GN 2/1.



**Roasting pan with cover**

Brasiera con coperchio  
Brasiere mit Deckel  
Braisière avec couvercle  
Rustidera alta con tapa

art.	cm.	h.
11965-50	50x30	15
11965-60	60x35	15
11965-61*	61x43	15

\*For 2/1 GN ovens. – Per forno GN 2/1.



**Fish kettle**

Pesciera  
Fischkochkessel  
Poissonnière  
Hervidor pescado

art.	cm.	h.	lt.
11963-99	100x25	20	44

**Equipped with grid and cover.**  
Fornita con griglia e coperchio.



INDUCTION  
READY!

**Fish kettle**

Pesciera  
Fischkochkessel  
Poissonnière  
Hervidor pescado

art.	cm.	h.
41964-45	46x15,5	10,5
41964-60	61,5x18,5	11,0

**Equipped with grid and cover.**  
Fornita con griglia e coperchio.



**Whistling kettle**

Bollitore  
Kocher  
Bouilloire à sifflet  
Pava

art.	lt.
41914-03	2,8



**Fry dripping tray, stainless steel**

Colafritto, inox  
Pommes-Frites-Seiher, Edelstahl Rostfrei  
Egouttoir à friture, inox  
Escurridor para fritura, inox

art.	Ø cm.	h.
41930-39	41	14

**Detachable drip tray.**  
Vassoio raccogli liquidi removibile.



**Canister**

Contentitore cilindrico  
Behälter  
Bahut  
Contenedor cilíndrico

art.	Ø cm.	h.	lt.
11913-16	16	12	2,4
11913-20	20	16	5,0
11913-24	24	20	9,0
11913-28	28	24	14,5



**Bain-marie pot**

Casseroola bagnomaria  
Wasserbadkasserolle  
Casserole bain-marie  
Baño maria

art.	Ø cm.	h.	lt.
11910-12	12	14	1,4
11910-14	14	16	2,5
11910-16	16	18	3,6
11910-18	18	20	5,0
11910-20	20	22	7,0



**Bain-marie pot**

Bagnomaria  
Behälter  
Casserole bain-marie  
Baño maria

art.	Ø cm.	h.	lt.
11911-12	12	14	1,4
11911-14	14	16	2,5
11911-16	16	18	3,6
11911-18	18	20	5,0
11911-20	20	22	7,0



**Bain-marie, stackable**

Bagno-maria impilabili  
Bain-Marie, stapelbar  
Bain-marie, empilables  
Baño maria, apilable

art.	cm.	h.	lt.
44501-01	24x24	23,5	13,0
44501-02	24x24	16,0	9,0
44501-03	24x24	7,5	4,0



**Bain-marie, stackable**

Bagno-maria impilabili  
Bain-Marie, stapelbar  
Bain-marie, empilables  
Baño maria, apilable

art.	cm.	h.	lt.
44502-01	15,5x15,5	23,5	5,0
44502-02	15,5x15,5	16,0	3,5
44502-03	15,5x15,5	7,5	1,5



**Bain-marie, stackable**

Bagno-maria impilabili  
Bain-Marie, stapelbar  
Bain-marie, empilables  
Baño maria, apilable

art.	cm.	h.	lt.
44503-01	15,5x10,5	16,0	2,5
44503-02	15,5x10,5	7,5	1,0
44503-03	15,5x10,5	5,5	0,5



**Bain-marie lid**

Coperchio bagnomaria  
Wasserbadkasserolle-Deckel  
Couverte pour bain-marie  
Tapa para baño maria

art.	cm.
44501-04	24x24
44502-04	15,5x15,5
44503-04	15,5x10,5



**1/4-Segment colander**

Colapasta 1/4  
1/4 Seiher-Einsatz  
Passoire cuit-pâtes, 1/4  
Colador 1/4

art.	Ø cm.	h.	lt.
11922-36	36	23	5,5
11922-40	40	26	7,5

**For items/Per art.:**  
**11007-11107-12007-12107-16929.**



**1/4-Segment wire colander**

Colapasta 1/4 a rete  
1/4 Netzseiher-Einsatz  
Passoire cuit-pâtes à gaze, 1/4  
Colador red 1/4

art.	Ø cm.	h.
12992-36	36	23
12992-40	40	26

**For items/Per art.:**  
**11007-11107-12007-12107-16929.**





# SERIES 6100

ALUMINUM COOKWARE  
PENTOLAME ALLUMINIO



Made in heavy duty aluminum.  
Hollow tubular handles in stainless steel 18/10, stay cool.  
Rounded corners provide easy cleanup.  
Thickness from mm 2 to mm 5,5.

Esecuzione in alluminio pesante.  
Manicatura tubolare in acciaio inossidabile 18/10, resistente al calore.  
Ampio raggio di raccordo fondo-parete, igienico e facile da pulire.  
Spessore da mm 2 a mm 5,5.



**Stock pot**

Pentola  
Hoher Suppentopf  
Marmite traiteur  
Olla recta

art.	Ø cm.	h.	lt.
16101-16	16	16,0	3,2
16101-20	20	20,0	6,2
16101-24	24	24,0	10,0
16101-28	28	28,0	16,5
16101-32	32	29,5	22,0
16101-36	36	36,0	36,0
16101-40	40	40,0	50,0
16101-45	45	45,0	70,0
16101-50	50	50,0	100,0



**Saucepot**

Casseruola alta  
Fleischtopf  
Brasière  
Cacerola alta

art.	Ø cm.	h.	lt.
16107-16	16	11,0	2,1
16107-20	20	13,0	4,0
16107-24	24	15,0	6,5
16107-28	28	17,5	10,8
16107-32	32	19,5	15,7
16107-36	36	21,0	21,5
16107-40	40	24,0	30,0
16107-45	45	27,0	43,0
16107-50	50	30,0	59,0



**Casserole pot**

Casseruola bassa  
Bratentopf  
Sautoir  
Cacerola baja

art.	Ø cm.	h.	lt.
16109-24	24	9,5	4,3
16109-28	28	11,0	6,7
16109-32	32	12,5	10,0
16109-36	36	14,0	14,0
16109-40	40	16,0	20,0
16109-45	45	18,0	28,5
16109-50	50	19,0	37,0
16109-60	60	21,5	60,0



**Colander for stock pot**

Colapasta per pentola  
Seiher für Suppentopf  
Passoire pour marmite  
Colador para olla recta

art.	Ø cm.	h.
16926-32	32	31
16926-36	36	37
16926-40	40	40



**Couscous pan**

Couscoussiera  
Couscoustopf  
Couscoussier  
Cuscusera

art.	Ø cm.	h.	lt.
46970-18	36	22+17	18
46970-25	40	25+20	25



**Potato steamer pot with cover**

Casseruola a vapore con coperchio  
Kartoffeldämpfer mit Deckel  
Marmite à pommes-de-terre avec couvercle  
Cuscusera con tapa

art.	Ø cm.	h.	lt.
16923-32	32	21+15	12
16923-36	36	23+17	18
16923-40	40	25+20	25



**Oval saucepan with cover**

Casseruola ovale con coperchio  
Ovale Kasserolle mit Deckel  
Casserole ovale avec couvercle  
Cacerola oval con tapa

art.	Ø cm.	h.	lt.
16938-36	36	14,5	10
16938-40	40	16,0	14
16938-45	45	17,0	19



**Saucepan**

Casseruola alta  
Stielkasserolle, hoch  
Casserole haute  
Cazo recto alto

art.	Ø cm.	h.	lt.
16106-16	16	11,0	2,1
16106-20	20	13,0	4,0
16106-24	24	15,0	6,5
16106-28	28	17,5	10,8



**Casserole pot**

Casseruola bassa  
Stielkasserolle, niedrig  
Sautoir  
Cacerola baja

art.	Ø cm.	h.	lt.
16108-20	20	8,0	2,5
16108-24	24	9,5	4,3
16108-28	28	11,0	6,7



**Frypan**  
Padella  
Bratpfanne  
Poêle à frire  
Sartén

art.	Ø cm.	h.
16114-20	20	4,0
16114-24	24	5,0
16114-28	28	5,0
16114-32	32	5,3
16114-36	36	6,0
16114-40	40	7,0



**French omelet pan**  
Tegame  
Servierpfanne  
Poêle à paella  
Paellera

art.	Ø cm.	h.
16115-24	24	5,5
16115-28	28	6,0
16115-32	32	6,5
16115-36	36	7,0
16115-40	40	7,5
16115-45	45	7,5



**Cover**  
Coperchio  
Deckel  
Couvercle  
Tapa

art.	Ø cm.
16961-16	16
16961-20	20
16961-24	24
16961-28	28
16961-32	32
16961-36	36
16961-40	40
16961-45	45
16961-50	50
16961-60	60



**Casserole pot, non stick**  
Casseruola alta, antiaderente  
Fleischtopf, nichttaftend  
Brsière, anti-adhérente  
Cacerola alta, antiadherente

art.	Ø cm.	h.	lt.
16127-16	16	11,0	2,1
16127-20	20	13,0	4,0
16127-24	24	15,0	6,5
16127-28	28	17,5	10,8
16127-32	32	19,5	15,7
16127-36	36	21,0	21,5
16127-40	40	24,0	30,0



**Casserole pot, non stick**  
Casseruola bassa, antiaderente  
Bratentopf, nichttaftend  
Sautoir, anti-adhérente  
Cacerola baja, antiadherente

art.	Ø cm.	h.	lt.
16120-24	24	9,5	4,3
16120-28	28	11,0	6,7
16120-32	32	12,5	10,0
16120-36	36	14,0	14,0
16120-40	40	16,0	20,0



**French omelet pan, non stick**  
Tegame, antiaderente  
Servierpfanne, nichttaftend  
Poêle à paella, anti-adhérente  
Paellera antiadherente

art.	Ø cm.	h.
16116-28	28	6,5
16116-32	32	6,5
16116-36	36	7,0
16116-40	40	7,5



**Frypan, non stick**  
Padella, antiaderente  
Bratpfanne, nichttaftend  
Poêle, anti-adhérente  
Sartén antiadherente

art.	Ø cm.	h.
41720-18	18	3,8
41720-20	20	3,8
41720-24	24	4,5
41720-28	28	5,4
41720-30	30	5,4
41720-32	32	5,6



**Frypan, non stick**  
Padella, antiaderente  
Bratpfanne, nichttaftend  
Poêle, anti-adhérente  
Sartén antiadherente

art.	Ø cm.	h.
16117-20	20	4,0
16117-24	24	5,0
16117-28	28	5,0
16117-32	32	5,3
16117-36	36	6,0
16117-40	40	7,0



**Forged frypan, non stick**  
Padella forgiata, antiaderente  
Pfanne, geschmiedet, nichttaftend  
Poêle forgée, anti-adhérente  
Sartén forjada, antiadherente

art.	Ø cm.	h.
11617-20	20	3,4
11617-24	24	4,2
11617-28	28	4,5
11617-32	32	5,5





**Frypan, non stick, cast iron handle**

Padella bombata antiaderente, manico ferro  
Bratpfanne, nichttaftend, Gusseisen-Stiel  
Poêle bombé, anti-adhérente, queue fonte  
Sartén antiadherente, mango hierro

art.	Ø cm.	h.
16113-20	20	5,5
16113-24	24	6,5
16113-28	28	7,0
16113-32	32	7,5
16113-36	36	8,0
16113-40	40	8,5



**Frypan, non stick, cast iron handle**

Padella antiaderente, manico ferro  
Bratpfanne, nichttaftend, Gusseisen-Stiel  
Poêle, anti-adhérente, queue fonte  
Sartén antiadherente, mango hierro

art.	Ø cm.	h.
16717-20	20	4,0
16717-24	24	5,0
16717-28	28	5,0
16717-32	32	5,3
16717-36	36	6,0
16717-40	40	7,0



**Crêpes pan, non stick**

Padella crêpes, antiaderente  
Crêpepfanne, nichttaftend  
Poêle à crêpes, anti-adhérente  
Sartén crêpes antiadherente

art.	Ø cm.
16118-24	24



**Non-stick blinis pan**

Padella per blini, antiaderente  
Blinis-Pfännchen, nichttaftend  
Poêle à blinis, anti-adhérente  
Sartén blinis, antiadherente

art.	Ø cm.	h.
16719-12	12	2



**Crêpes pan, non-stick**

Padella crêpes antiaderente  
Crêpes-Pfanne, nichttaftend  
Tuile à crêpes anti-adhérente  
Sartén para crêpes, antiadherente

art.	Ø cm.
16712-22	22
16712-26	26
16712-30	30



**Bake roasting pan**

Tegame  
Pfanne  
Plat à four  
Rustidera

art.	cm.	h.
16941-40	40x26	7,5
16941-45	45x30	7,5
16941-50	50x30	8,0
16941-60	60x35	9,0
16941-61*	61x43	9,0

\*For 2/1 GN ovens. – Per forno GN 2/1.



**Bake roasting pan**

Tegame  
Pfanne  
Plat à four  
Rustidera

art.	cm.	h.
16943-40	40x26	7,5
16943-45	45x30	7,5
16943-50	50x30	8,0
16943-60	60x35	9,0
16943-61*	61x43	9,0

\*For 2/1 GN ovens. – Per forno GN 2/1.



**Bake roasting, non stick**

Tegame, antiaderente  
Pfanne, nichttaftend  
Plat à four, anti-adhérente  
Rustidera antiadherente

art.	cm.	h.
16947-40	40x26	7,5
16947-45	45x30	7,5
16947-50	50x30	8,0
16947-60	60x35	9,0
16947-61*	61x43	9,0

\*For 2/1 GN ovens. – Per forno GN 2/1.



**Lid for roasting pans**

Coperchio per tegami  
Deckel für Bräter  
Couvercle pour plaques à rôtir  
Tapa para rustidera

art.	cm.
16948-40	40x26
16948-45	45x30
16948-50	50x30
16948-60	60x35
16948-61	61x43





**Bake roasting pan**

Tegame basso  
Pfanne, flach  
Plat à four bas  
Bandeja horno

art.	cm.	h.
16944-45	45x30	4
16944-50	50x30	4
16944-60	60x35	4



**Roasting pan with cover**

Brasiera con coperchio  
Brasiera mit Deckel  
Braisière avec couvercle  
Rustidera alta con tapa

art.	cm.	h.	lt.
16965-40	40x26	15	14
16965-50	50x30	15	21
16965-60	60x35	15	30



**Fish kettle**

Pesciera  
Fisch-Kochkessel  
Poissonnière  
Hervidor pescado

art.	cm.	h.	lt.
16939-50	50x15	12	9
16939-60	60x17	13	13
16939-70	70x19	14	18
16939-80	80x24	17	30

Equipped with grid and cover. – Fornita con griglia e coperchio.



**Sauce-pot, aluminum**

Casseruola, alluminio  
Gemüsetopf, Aluminium  
Braisière, alu  
Cacerola, aluminio

art.	Ø cm.	h.	lt.
16929-36	36	17	17,0
16929-40	40	18	22,5

Supplied without colanders. – Fornita senza spicchi.



**1/4-Segment wire colander**

Colapasta 1/4 a rete  
1/4 Netzseihier-Einsatz  
Passoire cuit-pâtes à gaze, 1/4  
Colador red 1/4

art.	Ø cm.	h.
12992-36	36	23
12992-40	40	26



**Bain-marie pot**

Bagnomaria  
Wasserbadkasserolle  
Casserole bain-marie  
Baño maria

art.	Ø cm.	h.	lt.
16910-14	14	16	2,5
16910-16	16	18	3,7
16910-18	18	20	5,0
16910-20	20	22	7,0



# STEEL FRYING PANS PADELLE FERRO



Iron is ideal for cooking at high temperatures because its low capacity of heat transmission prevents temperature leaps. As it is non-stick, food does not stick to it. It withstands very high temperatures and improves its performance with use. Iron pans are perfect for fried food, omelettes or fine crêpes. Wash the black iron pan in water as little as possible and always keep it greased. Iron pans are ideal also for cooking on induction hobs.

Il ferro è ottimo per le cotture a fuoco molto vivo perché, non avendo un'alta capacità di trasmettere calore, evita improvvisi sbalzi di temperatura. Essendo un materiale antiaderente, evita l'attaccamento dei cibi. Sopporta temperature elevatissime e col tempo migliora il suo rendimento. I recipienti in ferro sono i più adatti per frittare, omelette o sottili crêpes. La padella in ferro nera va lavata con acqua il meno possibile e mantenuta sempre unta. Il ferro è il materiale ideale anche per cotture a induzione.



**Blacksteel fish pan**  
Padella ovale  
Fischeisenpfanne, oval  
Coupe ovale  
Sartén oval

art.	cm.	h.
41719-32	32x23	5,0
41719-36	36x26	5,0
41719-40	40x28	5,5



**Blacksteel crêpes pan**  
Padella crêpes  
Crêpes Eisenpfanne  
Coupe lyonnaise à crêpes  
Sartén crêpes

art.	Ø cm.	h.
11718-20	20	2
11718-22	22	2
11718-24	24	2



**Blinis pan**  
Padella per blini  
Blinis-Eisenpfännchen  
Poêle à blinis  
Sartén blinis

art.	Ø cm.	h.
11715-12	12	2



**Heavy blacksteel frypan**  
Padella lionese, pesante  
Schwere Eisenpfanne  
Coupe lyonnaise extra-forte  
Sartén honda pesada

art.	Ø cm.	h.
11714-20	20	3,8
11714-22	22	4,0
11714-24	24	4,5
11714-26	26	4,5
11714-28	28	4,5
11714-32	32	5,0
11714-36	36	5,5
11714-40	40	5,5
11714-45	45	5,5
11714-50	50	6,0



**Blacksteel frypan**  
Padella lionese  
Eisenpfanne  
Coupe lyonnaise  
Sartén honda

art.	Ø cm.	h.
11716-16	16	4,0
11716-20	20	4,5
11716-22	22	4,5
11716-24	24	5,0
11716-26	26	5,5
11716-28	28	5,5
11716-32	32	6,0
11716-36	36	6,5
11716-40	40	7,0
11716-45	45	8,0



**Blacksteel paella pan**  
Padella per paella  
Paella Eisenpfanne  
Coupe lyonnaise à paella  
Paellera

art.	Ø cm.	h.
11717-34	34	5,0
11717-37	37	5,5
11717-42	42	6,0
11717-47	47	6,5
41717-60	60	6,5
41717-80	80	9,0



**Blacksteel fish pan**  
Padella ovale  
Fischeisenpfanne, oval  
Coupe ovale  
Sartén oval

art.	cm.
41703-38	38x26



**Wok pan**  
Wok  
Wok-Pfanne  
Poêle chinoise  
Wok

art.	Ø cm.	h.
11713-32	32	10
11713-40	40	11



**Chestnut pan**  
Padella per castagne  
Kastanienpfanne  
Poêle à marrons  
Sartén para castañas

art.	Ø cm.
11721-28	28



**Silicone sleeve**  
Coprimanico silicone  
Silikon-Stielhülle  
Revêtement manche en silicone  
Cubre mango silicona

art.	Ø cm.	col.
11710-AA	20-36	●
11710-AB	40-50	●

Heat resistant up to 230°C. Resistenza al calore fino a 230°C. Suits items! Per art: 16717, 16113, 16712, 11714, 11716, 11718, 11713, 11721.



**Fry pan**  
Padella per friggere  
Frittier-Pfanne  
Tuile à frire  
Sartén freidora

art.	Ø cm.	h.	lt.
41707-32	32	9,8	6,0
41707-36	36	11,0	8,8
41707-40	40	13,4	12,2
41707-45	45	15,0	17,3
41707-50	50	17,6	23,5



**Wire basket, tinned**  
Cestello per friggere, stagnato  
Frittier-Rost, verzinkt  
Grille à frire, étamée  
Cesta escurrefrito, estañada

art.	Ø cm.	h.
41708-32	32	11,0
41708-36	36	11,5
41708-40	40	12,4
41708-45	45	15,5
41708-50	50	16,5



# SERIES 15500 3-PLY

COPPER COOKWARE  
PENTOLAME RAME



Ideal for cooking and serving from the kitchen to the table. A working tool with a body made of three metals, copper, aluminum and steel. A mix for a homogenous and sweet thermal spread that ensures cooking without attacking the foods, preserving its nutritional properties and organoleptic characteristics. Inside stainless steel, practical and easy to clean. Middle layer aluminum, lightweight and a very good heat conductor. Exterior glossy copper finishing, a tradition in the kitchen, fascinating and beautiful to see. Solid brass handles assembled with strong section rivets. Suitable for use on all cooking hobs including induction.

Ideale per cucinare e servire nello stesso recipiente. Uno strumento di lavoro con un corpo formato da tre metalli, rame, alluminio e acciaio. Un mix per un'omogenea e dolce diffusione termica che assicura una cottura senza aggredire i cibi, preservandone le proprietà nutrizionali e le caratteristiche organolettiche. Lamina interna in acciaio inox, pratico e facile da pulire. Strato intermedio in alluminio, leggero e ottimo conduttore di calore. Esterno in rame finitura lucida, una tradizione in cucina, affascinante e bello da vedere. Manici e maniglie in ottone massiccio assemblati con rivetti di forte sezione. Adatto ad uso su tutti i fuochi inclusa l'induzione.



**Saucepan**

Casseruola alta  
Stielkasserolle, hoch  
Casserole haute  
Cazo recto alto

art.	Ø cm.	h.	lt.
15506-16	16	8	1,6
15506-20	20	11	3,5
15506-24	24	14	6,3
15506-28	28	16	9,8



**Casserole pot**

Casseruola bassa  
Stielkasserolle, niedrig  
Sautoir  
Cacerola baja

art.	Ø cm.	h.	lt.
15508-20	20	7	2,2
15508-24	24	8	3,6
15508-28	28	9	5,5



**Frypan**

Padella  
Bratpfanne  
Poêle à frire  
Sartén

art.	Ø cm.	h.	lt.
15514-20	20	4,5	1,4
15514-24	24	4,5	2,0
15514-28	28	5,5	3,4
15514-32	32	6,0	4,8



**Saucepot**

Casseruola alta  
Fleischtopf  
Brasière  
Cacerola alta

art.	Ø cm.	h.	lt.
15507-16	16	8	1,6
15507-20	20	11	3,5
15507-24	24	14	6,3
15507-28	28	16	9,8



**Casserole pot**

Casseruola bassa  
Bratentopf  
Sautoir  
Cacerola baja

art.	Ø cm.	h.	lt.
15509-20	20	7	2,2
15509-24	24	8	3,6
15509-28	28	9	5,5



**Frypan**

Padella  
Bratpfanne  
Poêle à paella  
Paellera

art.	Ø cm.	h.	lt.
15515-20	20	4,5	1,4
15515-24	24	4,5	2,0
15515-28	28	5,5	3,4
15515-32	32	6,0	4,8



**Cover**

Coperchio  
Deckel  
Couvercle  
Tapa

art.	Ø cm.
15561-20	20
15561-24	24
15561-28	28





# MINI COOKWARE

## MINIATURE SERIES 15200 3-PLY

**COPPER COOKWARE**  
PENTOLAME RAME



Paderno Serie 15200 3-ply, inside stainless steel satin polished, intermediate layer in aluminum, outside copper mirror polished. Thickness 1,8 mm. Stainless steel handles with PVD gold finishing, stainless steel rivets. For use on any heating element (except on induction hob).

Serie Paderno 15200 3-ply, lamina interna in acciaio inox finitura satinata, strato intermedio in alluminio, esterno rame lucido. Spessore 1,8 mm. Manicatura in acciaio inox con finitura PVD oro, rivetti inox. Adatte ad uso su tutti i fuochi (eccetto induzione).



### Saucepan

Casseruola alta  
Stielkasserolle, hoch  
Casserole haute  
Cazo recto alto

art.	Ø cm.	h.	lt.
15226-07	7	4,0	0,15
15228-10	10	4,5	0,35



### Saucepan

Casseruola alta  
Stielkasserolle, hoch  
Casserole haute  
Cazo recto alto

art.	Ø cm.	h.	lt.
15226-10	10	7	0,50
15226-12	12	8	0,85
15226-14	14	9	1,30



### Frypan

Padella  
Bratpfanne  
Poêle à paella  
Paellera

art.	Ø cm.	h.	lt.
15224-10	10	3,0	0,20
15224-12	12	3,5	0,35
15224-14	14	4,5	0,70



### Saucepot

Casseruola alta  
Fleischtopf  
Brasière  
Cacerola alta

art.	Ø cm.	h.	lt.
15227-10	10	7	0,50
15227-12	12	8	0,85
15227-14	14	9	1,30



### Casserole pot

Casseruola bassa  
Bratentopf  
Sautoir  
Cacerola baja

art.	Ø cm.	h.	lt.
15229-10	10	4,5	0,35



### Omelet pan

Tegame  
Servierpfanne  
Poêle à paella  
Paellera

art.	Ø cm.	h.	lt.
15225-10	10	3,0	0,20
15225-12	12	3,5	0,35
15225-14	14	4,5	0,70



### Cover

Coperchio  
Deckel  
Couvercle  
Tapa

art.	Ø cm.
15261-10	10
15261-12	12
15261-14	14





# SERIES 15300-15400

COPPER COOKWARE  
PENTOLAME RAME



Solid copper, thickness from 1,5 to 2,5 mm, the interiors are tinned over the fire by hand. Handles in highly polished solid brass, assembled with wide rivets. For use on any heating element (except on induction hob).

Rame massiccio, spessore da 1,5 a 2,5 mm internamente stagnato a mano sulla fiamma. Manici e maniglie in ottone massiccio lucidato a specchio ed assemblati con rivetti di forte sezione. Adatto ad uso su tutti i fuochi (eccetto induzione).



**Oval saucepan**  
Casseruola ovale  
Ovaler Bratentopf  
Casserole ovale  
Cacerola oval

art.	cm.	h.
15338-38	38x25	13



**Bake roasting pan**  
Tegame rettangolare  
Rechteckige Pflanne  
Plat à four  
Rustidera

art.	cm.	h.
15343-36	38x28	11



**Oval pan**  
Tegame ovale  
Ovale Bratpfanne  
Plat ovale à poignées  
Bandeja oval

art.	cm.	h.
15339-36	38x26	11



**Fish kettle**  
Pesciera  
Fischkochkessel  
Poissonnière  
Hervidor pescado

art.	cm.	h.
15438-50	50x18	11



**Bain-marie**  
Bagnomaria  
Wasserbadkasserolle  
Bain-marie  
Baño maría

art.	Ø cm.	h.
15403-16	16	17

**With porcelain. – Con porcellana.**



**Fondue set**  
Set fonduta  
Fondue-Service  
Service à fondue  
Servicio para fondues

art.	Ø cm.	h.
15430-11	16	26



**Sugar saucepan**  
Casseruola per zucchero  
Zuckerpfännchen  
Poelon à sucre  
Cacerola para azúcar

art.	Ø cm.	h.
15406-16	16	9
15406-20	20	10



**Zabaione bowl**  
Casseruola per zabaione  
Zabaionekasserolle  
Poelon à zabaione  
Cacerola sabayón

art.	Ø cm.
15407-16	16
15407-20	20



**Foot for zabaione bowl**  
Base per casseruola zabaione  
Fuss für Zabaionekasserolle  
Base pour poelon à zabaione  
Base para cacerola sabayón

art.	Ø cm.	h.
15401-51	8	4,5



**Mixing bowl**  
Bastardella semisferica  
Schneeslagkessel  
Bassine hémisphérique  
Caldero

art.	Ø cm.
15409-26	26
15409-30	30
15409-36	36

**Frosted finishing. – Finitura smerigliata.**



**Bordelais moulds**  
Stampo scanalato  
Bordelais-Kuchenform  
Moule à cannelés Bordelais  
Molde para bordelais

art.	Ø cm.	h. mm.
15415-03	5,5	5

**3 pcs set. – Set 3 pezzi.**





# MINI COOKWARE MINIATURE

COOKWARE  
PENTOLAME



Aluminum body non-stick coated, brass handles. A range of small pots ideal for side dishes and individual servings, soufflés, baked pasta, rice creams, raclette, savory as well as sweet pastries, desserts, etc.. Versatile, functional, ready to be served from the kitchen to the table. Original and yet traditional, they come from the world of haute cuisine, ideal for enhancing creations or the most simple recipes, for the sake of conviviality, to give a more playful aspect to our meals.

Corpo in alluminio con rivestimento antiaderente, manichatura in ottone. Una gamma di miniature ideali per contorni e singole porzioni, soufflé, pasta al forno, creme di riso, raclette, brioche salate e dolci, dessert, ecc., ecc.. Polivalenti, funzionali, pronte per essere servite dalla cucina alla tavola. Originali eppure tradizionali, provengono dal mondo dell'alta gastronomia, strumento ideale per valorizzare creazioni estrose o le più semplici ricette, per amore della convivialità, per donare un aspetto più ludico ai nostri pasti.



## Saucepan

Casseruola alta  
Stielkasserole, hoch  
Casserole haute  
Cazo recto alto

art.	Ø cm.	h.	lt.
16136-10	10	6	0,45



## Sauté pan

Casseruola bassa  
Stielkasserole, niedrig  
Plat à sauter  
Cazo recto bajo

art.	Ø cm.	h.	lt.
16138-10	10	4	0,3



## Frypan

Padella  
Bratpfanne  
Poêle à frire  
Sartén

art.	Ø cm.	h.	lt.
16134-12	12	4	0,4



## Saucepan

Casseruola alta  
Fleischtopf  
Casserole haute  
Cazo recto alto

art.	Ø cm.	h.	lt.
16137-10	10	6	0,45



## Casserole pot

Casseruola bassa  
Bratentopf  
Sautoir  
Cacerola baja

art.	Ø cm.	h.	lt.
16139-10	10	4	0,3



## French omelet pan

Tegamino  
Servierpfanne  
Poêle à paella  
Paellera

art.	Ø cm.	h.	lt.
16135-12	12	4	0,4



**Blinis pan, non-stick aluminum**  
Padella blini, alluminio antiaderente  
Blinis-Pfännchen, Alu-Nichttaftend  
Poêle à blinis, alu anti-adhérente  
Sartén blinis, aluminio antiadherente

art.	Ø cm.	h.
16719-12	12	2



**Blinis pan, steel**  
Padella blini, ferro  
Blinis-Pfännchen, Eisen  
Poêle à blinis, acier  
Sartén blinis, hierro

art.	Ø cm.	h.
11715-12	12	2



**Sauté pan with double spouts**  
Casseruola con due becchi, 3-ply  
Stielkasserolle, niedrig, 2 Schnabel  
Plat à sauter, 2 becs  
Cazo recto bajo, 2 picos

art.	Ø cm.	h.	lt.
12511-10	10	5	0,4

**Mirror finishing. – Finitura lucida.**



**Sauté pan**  
Casseruola bassa, 3-ply  
Stielkasserolle, niedrig  
Plat à sauter  
Cazo recto bajo

art.	Ø cm.	h.	lt.
12511-12	12	6	0,7

**Mirror finishing. – Finitura lucida.**



**Sauté pan**  
Casseruola bassa, 3-ply  
Stielkasserolle, niedrig  
Plat à sauter  
Cazo recto bajo

art.	Ø cm.	h.	lt.
12511-14	14	7	1

**Mirror finishing. – Finitura lucida.**



**Saucepot with lid**  
Casseruola con coperchio, 3-ply  
Fleischtopf mit Deckel  
Brasière avec couvercle  
Cacerola alta con tapa

art.	Ø cm.	h.	lt.
12509-12	12	6	0,7

**Mirror finishing. – Finitura lucida.**



**Saucepan, oval, Stoneware**  
Casseruola ovale  
Kasserolle, oval  
Casserole, ovale  
Cacerola, oval

art.	cm.	h.
41210-03	13x8,2	3,9



**Saucepan, Stoneware**  
Tegamimo  
Pfännchen  
Sautoir  
Fuente huevo

art.	Ø cm.	h.
41210-12	13	5
41210-13	15	5
41210-14	17	5



**Saucepan, rectangular, Stoneware**  
Casseruola rettangolare  
Kasserolle, rechteckig  
Casserole, rectangulaire  
Cacerola, rectangular

art.	cm.	h.
41210-05	13x8,2	3,9



**Piepan, Stoneware**  
Tortiera  
Kuchenform  
Ramequin  
Molde tarta

art.	Ø cm.	h.
41210-10	11	3,9



**Saucepan, round, Stoneware**  
Casseruola tonda  
Kasserolle, rund  
Casserole, ronde  
Cacerola, redonda

art.	Ø cm.	h.
41210-01	13	3,9



**Saucepan with lid, Stoneware**  
Casseruola con coperchio  
Kasserolle mit Deckel  
Casserole avec couvercle  
Cacerola con tapa

art.	Ø cm.	h.
41210-07	11,5	5,5
41210-08	13,0	7,5

# ENAMELLED CAST IRON GHISA SMALTATA

COOKWARE  
PENTOLAME



Suitable for use on all cooking hobs (gas, electric, ceramic, induction) and ovens (gas, oil, coal or wood) except microwave. A perfect harmony of cast iron, enamel and high quality. Designed and constructed to absorb and spread the heat evenly. Cast iron is suitable for all cooking techniques, for soups, roasts, rice, desserts, for braise that require a long cooking and likewise ideal for meats and grilled vegetables as it enhances flavors and aromas like barbecue style. Cast iron also features non-stick. The high temperature of the pan sears the meat surface. All the flavor, water and nutritional values remain sealed in the food. When cooking in casseroles, the steam generated thanks to the special design of the cover condenses falling back into the food not only retaining flavors and aromas but providing the best protection for nutrients and contributing to a healthy diet. Cast iron is a material 100% recyclable and therefore environmentally friendly. Moreover, thanks to its ability to retain heat for a long time it allows a considerable saving of energy. With closed lid on the table, the pot will preserve the temperature for a second serving. Cast iron retains the heat but as well the cold... can be used to keep the food fresh. Stored for a short time in the refrigerator, keeps food cool during hot summer days, ideal for serving pasta or rice salads, etc. Practical and easy to clean. These cast iron pots and pans are dishwasher safe thanks to the special technology applied to their enameling method. Ergonomic knobs and handles made of cast iron and stainless steel, suitable for use on all heat sources and ovens except microwave. Be careful, they heat up during cooking, it is recommended to handle with a dry thick cloth.

Idonee all'uso su tutte le fonti di cottura (gas, elettriche, vetroceramica, induzione) e forni (gas, petrolio, carbone o legna) ad esclusione di microonde. Una perfetta armonia tra ghisa, smalto e alta qualità. Progettate e costruite per assorbire e diffondere il calore in modo uniforme. La ghisa è adatta a tutte le tecniche di cottura, per zuppe, arrostiti, risotti, dolci, per piatti che richiedono una lunga cottura tipo brasati e allo stesso modo ideale per carni e verdure alla griglia in quanto ne esalta sapori ed aromi in stile barbecue. La ghisa ha anche caratteristiche di antiaderenza. La temperatura elevata della padella cauterizza la superficie della carne. Tutto il sapore, l'acqua e i valori nutrizionali rimangono sigillati nel cibo. Nella cottura in casseruole, il vapore generato grazie al particolare design del coperchio si condensa ricadendo e mescolandosi nuovamente nel cibo non solo trattenendo sapori e aromi ma fornendo la miglior protezione alle sostanze nutrienti e contribuendo ad una dieta sana. La ghisa è un materiale riciclabile al 100% e quindi ecologico. Inoltre, grazie alla sua capacità di mantenere il calore per lungo tempo consente un notevole risparmio di energia permettendo di cuocere a fuoco basso. Anche a tavola mantengono in cibi in temperatura. La ghisa mantiene però il caldo come pure il freddo... può essere usata per mantenere il cibo fresco. Riposta per un breve periodo in frigorifero, mantiene il cibo fresco nelle calde giornate estive e ideale per servire insalate di pasta, riso, farro, ecc., ecc. Pratica e facile da pulire. Queste casseruole e padelle in ghisa sono lavabili in lavastoviglie, per merito della speciale tecnologia applicata al metodo di smaltatura. Manicatura e pomoli dal design ergonomico sono in ghisa e inox. Durante la cottura si raccomanda di maneggiare con un panno consistente e asciutto per evitare di scottarsi.



**Saucepot round with lid**  
Casseruola tonda con coperchio  
Fleischtopf, rund mit Deckel  
Brasière avec couvercle  
Cacerola redonda con tapa

art.	Ø cm.	lt.	col.
44201R10	10	0,35	●
44201V10	10	0,35	●
44201B10	10	0,35	●
44201O10	10	0,35	●
44201N10	10	0,35	●

Portion: – Porzioni: 1



**Saucepot round with lid**  
Casseruola tonda con coperchio  
Fleischtopf, rund mit Deckel  
Brasière avec couvercle  
Cacerola redonda con tapa

art.	Ø cm.	lt.	col.
44201R12	12	0,55	●
44201V12	12	0,55	●
44201B12	12	0,55	●
44201O12	12	0,55	●
44201N12	12	0,55	●

Portion: – Porzioni: 1



**Oval saucepan with lid**  
Casseruola ovale con coperchio  
Ovaler Bratentopf mit Deckel  
Casserole ovale avec couvercle  
Cacerola oval con tapa

art.	cm.	col.
44202R12	12x9x6	●
44202V12	12x9x6	●
44202B12	12x9x6	●
44202O12	12x9x6	●
44202N12	12x9x6	●

Portion: – Porzioni: 1



**Saucepot stand**  
Supporto casseruolina  
Fleischtopf-Träger  
Support pour brasière  
Soporte para cacerola

art.	Ø cm.
44201-01	10

W



**Saucepot stand**  
Supporto casseruolina  
Fleischtopf-Träger  
Support pour brasière  
Soporte para cacerola

art.	Ø cm.
44201-03	10

W



**Saucepot platter**  
Sottopentola  
Fleischtopfbrett  
Planche à casserole  
Tabla para cacerola

art.	Ø cm.
44201-10	10-12

W



**Saucepot platter**  
Sottopentola  
Fleischtopfbrett  
Planche à casserole  
Tabla para cacerola

art.	cm.
44202-10	12x9

W



**Soufflé pot with wooden platter**  
Coppa soufflé con piatto legno  
Ramekin mit Holzbrett  
Ramequin avec planche bois  
Fuente soufflé con tabla madera

art.	Ø cm.	lt.
44240S08	8	0,17

Portion: – Porzioni: 1



**Saucepot with lid**  
Casseruola alta con coperchio  
Fleischtopf mit Deckel  
Brasière avec couvercle  
Cacerola alta con tapa

art.	Ø cm.	lt.	Por.
44201R16	16	1,0	1-2
44201R20	20	2,6	2-3
44201R24	24	4,5	4-5
44201R28	28	6,7	6-8
44201R32	32	10,0	12-16



**Saucepot with lid**  
Casseruola alta con coperchio  
Fleischtopf mit Deckel  
Brasière avec couvercle  
Cacerola alta con tapa

art.	Ø cm.	lt.	Por.
44201N16	16	1,0	1-2
44201N20	20	2,6	2-3
44201N24	24	4,5	4-5
44201N28	28	6,7	6-8
44201N32	32	10,0	12-16



**Saucepot with glass lid**  
Casseruola alta coperchio vetro  
Fleischtopf mit Glasdeckel  
Brasière avec couvercle verre  
Cacerola alta con tapa vidrio

art.	Ø cm.	lt.	Por.
44203R20	20	2,6	2-3
44203R24	24	4,5	4-5
44203R28	28	6,7	6-8



**Oval saucepan with lid**  
Casseruola ovale con coperchio  
Ovaler Bratentopf mit Deckel  
Casserole ovale avec couvercle  
Cacerola oval con tapa

art.	Ø cm.	lt.	Por.
44202R25	25	3,3	4
44202R27	27	4,0	4-6
44202R29	29	4,8	6



**Oval saucepan with lid**

Casseruola ovale con coperchio  
Ovaler Bratentopf mit Deckel  
Casserole ovale avec couvercle  
Cacerola oval con tapa

art.	Ø cm.	lt.	Por.
44202N25	25	3,3	4
44202N27	27	4,0	4-6
44202N29	29	4,8	6



**Casserole pot with glass lid**

Casseruola bassa con coperchio vetro  
Bratentopf mit Glasdeckel  
Sautoir avec couvercle verre  
Cacerola baja con tapa vidrio

art.	Ø cm.	lt.	Por.
44204R24	24	2,4	4
44204R28	28	3,4	4-6



**Saucepan with glass lid**

Casseruola alta con coperchio vetro  
Stielkasserolle, hoch mit Glasdeckel  
Casserole haute avec couvercle verre  
Cazo recto alto con tapa vidrio

art.	Ø cm.	lt.	Por.
44239R16	16	1,0	1-2



**Frypan**

Padella  
Bratpfanne  
Poêle

**Sartén**

art.	Ø cm.	lt.	Por.
44205-16	16	0,42	1
44205-20	20	0,80	1-2



**Frypan wooden handle**

Padella manico legno  
Bratpfanne mit Holz-Griff  
Poêle manche bois

**Sartén mango madera**

art.	Ø cm.	lt.	Por.
44205-24	24	1,5	4
44205-28	28	2,5	4-6



**Wok pan**

Wok  
Wok-Pfanne  
Poêle chinoise

**Wok**

art.	Ø cm.	lt.	Por.
44247-38	38	5,3	4





**W**

**Platter with magnetic feature**

Sottopentola magnetico  
Untersetzer, magnetisch  
Sous-plat magnétique  
Posavasos magnético

art.	Ø cm.
44207-16	16
44207-20	20
44207-24	24
44207-28	28



**Grill pan**

Padella grill  
Grill-Pfanne  
Poêle grill  
Sartén grill

art.	cm.	lt.	Por.
44209R26	26x26	2,2	4
44209R32	26x32	2,6	6



**Grill pan**

Padella grill  
Grill-Pfanne  
Poêle grill  
Sartén grill

art.	cm.	lt.	Por.
44210-26	26x26	2,20	4
44210-32	26x32	2,75	6



**Silicone sleeves**

Coprimaniglie silicone  
Silikon-Griffhüllen  
Revêtement en silicone pour poignées  
Cubre asas de silicona

art.	col.
44208G00	●
44208R00	●



**Grill pan with wooden service stand**

Padella grill con tagliere a servire legno  
Grill-Pfanne mit Service-Holzbrett  
Poêle grill avec support à servir bois  
Sartén grill con tabla madera

art.	cm.	lt.	Por.
44210S26	26x26	2,20	4
44210S32	26x32	2,75	6



**Grill pan**

Padella grill  
Grill-Pfanne  
Poêle grill  
Sartén grill

art.	cm.	lt.	Por.
44210-42	31x42	4,5	8



**Grill pan with wooden service stand**

Padella grill con tagliere a servire legno  
Grill-Pfanne mit Service-Holzbrett  
Poêle grill avec support à servir bois  
Sartén grill con tabla madera

art.	cm.	lt.	Por.
44210S42	31x42	4,5	8



**Bake roasting dish**

Tegame rettangolare  
Pfanne, rechteckig  
Plat rectangulaire  
Rustidera

art.	cm.	Por.
44218R30	22x30	6-8
44218R40	26x40	8-12



**Terrine pot**

Terrina  
Pasteten-Pfanne  
Terrine rectangle  
Fuente rectangular

art.	cm.	Por.
44219R26	8,5x26,5x6	2-4



**Grill pan and wooden service stand**

Padella grill con tagliere a servire legno  
Grill-Pfanne mit Service-Holzbrett  
Poêle grill avec plaque à servir bois  
Sartén grill con tabla madera

art.	cm.	Por.
44216S16	16x16	1

**Cups not included. – Ciotoline non include.**





**Grill pan with wooden platter**  
Padella grill con tagliere legno  
Grill-Pfanne mit Holzbrett  
Poêle grill avec plaque bois  
Sartén grill con tabla madera

art.	cm.	Por.
44215S16	16x16	1



**Griddle plate, dual side, reversible**  
Griglia reversibile  
Grill-Platte, zweiseitig, reversible  
Gril rectangle, reversible  
Parrilla reversible

art.	cm.	Por.
44217-45	26x47	6-8



**Grill pan**  
Bistecchiera  
Grill-Pfanne  
Poêle grill  
Sartén grill

art.	Ø cm.	lt.	Por.
44212-30	30	2,35	4-6



**Grill pan**  
Bistecchiera  
Grill-Pfanne  
Poêle grill  
Sartén grill

art.	cm.	Por.
44213-24	24x24	1-2
44213-36	21x36	2-4



**Grill pan**  
Bistecchiera  
Grill-Pfanne  
Poêle grill  
Sartén grill

art.	Ø cm.	Por.
44214-25	25	2-3



**Fish plate with wooden platter**  
Piatto pesce con tagliere legno  
Fischplatte mit Holzbrett  
Plat à poisson avec planche bois  
Fuente pescado con tabla madera

art.	cm.	Por.
44220S24	15x24	1-2



**Fish plate with wooden platter**  
Piatto pesce con tagliere legno  
Fischplatte mit Holzbrett  
Plat à poisson avec planche bois  
Fuente pescado con tabla madera

art.	cm.	Por.
44221S30	15,5x29,5	1-2



**Pizza pan**  
Piatto pizza  
Pizza-Platte  
Plat à pizza  
Fuente para pizza

art.	Ø cm.	Por.
44222-20	20	1
44222-28	28	1



**Pizza pan with wooden platter**  
Piatto pizza con tagliere legno  
Pizza-Platte mit Holzbrett  
Plat à pizza avec planche bois  
Fuente para pizza con tabla madera

art.	Ø cm.	Por.
44222S20	20	1
44222S28	28	1



**Griddle plate, dual side, reversible**  
Griglia reversibile  
Grill-Platte, zweiseitig, reversible  
Gril rectangle, reversible  
Parrilla reversible

art.	cm.	Por.
44224-22	22x15	1-2



**Grill plate and wooden platter**

Griglia reversibile con tagliere legno  
Grill-Platte mit Service-Holzbrett  
Grill avec plaque à servir bois  
Parrilla con tabla madera

art.	cm.	Por.
44224S22	22x15	1-2



**Table barbecue**

Barbecue da tavola  
Tischgrillplatte  
Barbecue de table  
Parrilla de mesa

art.	cm.	Por.
44225-22	22x15	1-2

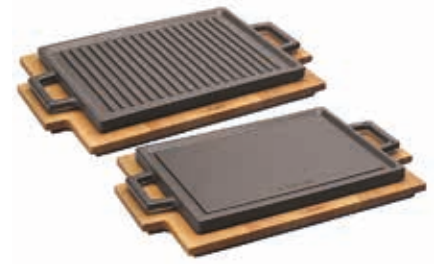

**Griddle with wooden platter**

Griglia con tagliere legno  
Grill-Platte mit Holzbrett  
Grill rectangle avec planche bois  
Parrilla con tabla madera

art.	cm.	Por.
44226S30	22x30	2-3



**Table barbecue**

Barbecue da tavola  
Tischgrillplatte  
Barbecue de table  
Parrilla de mesa

art.	cm.	Por.
44227-30	22x30	2-3



**Fajita plate with wooden platter**

Piatto fajita con tagliere legno  
Fajitaplatte mit Holzbrett  
Plat à fajitas avec planche bois  
Fuente fajitas con tabla madera

art.	cm.	Por.
44228S23	17x23	1



**Fajita plate with wooden platter**

Piatto fajita con tagliere legno  
Fajitaplatte mit Holzbrett  
Plat à fajitas avec planche bois  
Fuente fajitas con tabla madera

art.	cm.	Por.
44229S20	10x20	1



**Oval plate with wooden platter**

Piatto ovale con tagliere legno  
Ovalplatte mit Holzbrett  
Plat oval avec planche bois  
Fuente ovale con tabla madera

art.	cm.	Por.
44230S10	15x10x2,5	1
44230S14	21x14x2,5	1-2



**Oval plate with wooden platter**

Piatto ovale con tagliere legno  
Ovalplatte mit Holzbrett  
Plat oval avec planche bois  
Fuente ovale con tabla madera

art.	cm.	Por.
44231-14	21x14x2,5	1-2

**Cups not included. – Ciotoline non incluse.**



**Round plate with wooden platter**

Piatto tondo con tagliere legno  
Platte mit Holzbrett, rund  
Plat rond avec planche bois  
Fuente redonda con tabla madera

art.	Ø cm.	Por.
44232S12	12	1
44232S16	16	1-2
44232S20	20	2-3



**Round plate with wooden platter**

Piatto tondo con tagliere legno  
Platte mit Holzbrett, rund  
Plat rond avec planche bois  
Fuente redonda con tabla madera

art.	Ø cm.	lt.	Por.
44233-16	16	0,46	1-2
44233-20	20	0,74	3-4

**Cups not included. – Ciotoline non incluse.**



**Round pan**

Padella tonda  
Pfanne, rund  
Poêle ronde  
Sartén grill redonda

art.	Ø cm.	Por.
44234-12	12	1
44234-16	16	1-2





**Pan and wooden platter**

Padella con tagliere legno  
Pfanne mit Holzbrett  
Poêle avec plaque bois  
Sartén grill con tabla madera

art.	Ø cm.	lt.	Por.
44234S12	12	0,24	1
44234S16	16	0,45	1-2



**Pan and wooden platter**

Padella con tagliere legno  
Pfanne mit Holzbrett  
Poêle avec plaque bois  
Sartén grill con tabla madera

art.	Ø cm.	lt.	Por.
44235-16	16	0,45	1-2

**Cups not included.** – Ciotoline non incluse.



**Rectangular pan with wooden service stand**

Tegame con tagliere a servire legno  
Pfanne mit Service-Holzbrett  
Poêle avec support à servir bois  
Sartén con tabla madera

art.	cm.	Por.
44237S15	12x15	1-2



**Rectangular pan with wooden service stand**

Tegame con tagliere a servire legno  
Pfanne mit Service-Holzbrett  
Poêle avec support à servir bois  
Sartén con tabla madera

art.	cm.	Por.
44238-15	12x15	1-2

**Cups not included.** – Ciotoline non incluse.



**W**

**Tortillas cup**

Ciotola tortillas  
Tortillas-Schale  
Coupe-tortillas  
Copa tortillas

art.	Ø cm.
44241-19	19



**Soufflé pot, enameled cast iron**

Coppa soufflé, ghisa smaltata  
Ramekin, emailliertes Gusseisen  
Ramequin, fonte émaillée  
Fuente soufflé, hierro fundido esmaltado

art.	Ø cm.	lt.	Por.
44240-08	8	0,15	1



**PR**

**Sauce bowl**

Coppa salsa  
Saucentasse  
Bol à sauce  
Copa para salsa

art.	Ø cm.	h.
44242-00	6	2,7



**MF**

**Sauce bowl**

Coppa salsa  
Saucentasse  
Bol à sauce  
Copa para salsa

art.	Ø cm.	h.
44243-00	7,1	3,5



**Oval plate with wooden platter**

Piatto con tagliere legno  
Ovalplatte mit Holzbrett  
Plat oval avec planche bois  
Fuente ovale con tabla madera

art.	cm.	lt.	Por.
44223S19	12,5x19	0,23	1



**Griddle plate, reversible with wooden platter**

Griglia reversibile con tagliere legno  
Grill-Platte, reversible mit Holzbrett  
Gril reversible avec planche bois  
Plancha grill reversible con tabla madera

art.	Ø cm.	Por.
44236S28	28	4
44236S34	34	6



**Service dish with wooden stand**

Piatto servire con tagliere legno  
Servierplatte mit Holzbrett  
Plat à servir avec support en bois  
Plato para servir con tabla madera

art.	cm.	Por.
44245S32	32x20	1



**Service dish with porcelain surface**

Tagliere con superficie porcellanata  
Servierplatte mit Porzellan-Oberfläche  
Plat à servir avec surface en porcelaine  
Tabla con superficie porcelana

art.	cm.	Por.
44255-10	39,5x25x2,5	1

**Incl. casserole Ø 10 cm with lid. Sauce cups not included.** – Incl. casseruola c/cop. ø 10 cm. Coppette salsa escluse.



**Service dish with porcelain surface**  
Tagliere con superficie porcellanata  
Servierplatte mit Porzellan-Oberfläche  
Plat à servir avec surface en porcelaine  
Tabla con superficie porcelana

art.	cm.	Por.
44255-12	39,5x25x2,5	1

**Incl. oval casserole 12 cm with lid. Sauce cups not included.** – Incl. casseruola ovale c/cop. 12 cm. Coppette salsa escluse.



**Service dish with porcelain surface**  
Tagliere con superficie porcellanata  
Servierplatte mit Porzellan-Oberfläche  
Plat à servir avec surface en porcelaine  
Tabla con superficie porcelana

art.	cm.	Por.
44255-14	39,5x25x2,5	1
44255-16	39,5x25x2,5	1-2

**Incl. skillet ø 12/16 cm. Sauce cups not included.**  
Incl. padella ø 12/16 cm. Coppette salsa escluse.



**Service dish with porcelain surface**  
Tagliere con superficie porcellanata  
Servierplatte mit Porzellan-Oberfläche  
Plat à servir avec surface en porcelaine  
Tabla con superficie porcelana

art.	cm.	Por.
44255-15	39,5x25x2,5	1-2

**Incl. dish 12x15 cm. Sauce cups not included.**  
Incl. tegamino 12x15 cm. Coppette salsa escluse.



**Service dish with porcelain surface**  
Tagliere con superficie porcellanata  
Servierplatte mit Porzellan-Oberfläche  
Plat à servir avec surface en porcelaine  
Tabla con superficie porcelana

art.	cm.	Por.
44255-21	39,5x25x2,5	1-2

**Incl. dish 21x14 cm. Sauce cups not included.**  
Incl. tegamino 21x14 cm. Coppette salsa escluse.



**Service dish with porcelain surface**  
Tagliere con superficie porcellanata  
Servierplatte mit Porzellan-Oberfläche  
Plat à servir avec surface en porcelaine  
Tabla con superficie porcelana

art.	cm.	Por.
44255-22	39,5x25x2,5	1-2

**Incl. pan ø16 cm. Sauce cups not included.**  
Incl. tegamino ø 16 cm. Coppette salsa escluse.



**Plate pig with wooden platter**  
Piatto maiale con tagliere legno  
Platte Schwein mit Holzbrett  
Plat porc avec planche bois  
Plato cerdo con tabla madera

art.	cm.	lt.	Por.
44220S32	32,5x17,5	0,38	1-2



**Plate fish with wooden platter**  
Piatto pesce con tagliere legno  
Platte Fisch mit Holzbrett  
Plat poisson avec planche bois  
Plato pescado con tabla madera

art.	cm.	lt.	Por.
44220S38	24,5x16,5	0,12	1



**Pan with wooden platter**  
Tegame con tagliere legno  
Pfanne mit Holzbrett  
Poêle avec planche bois  
Paellera con tabla madera

art.	Ø cm.	cm.	lt.	Por.
44247S16	16	23,5x18,5	0,44	1-2



**Service dish with porcelain surface**  
Tagliere con superficie porcellanata  
Servierplatte mit Porzellan-Oberfläche  
Plat à servir avec surface en porcelaine  
Tabla con superficie porcelana

art.	cm.	lt.	Por.
44255-08	39,5x28x4,3	0,17	1

**Incl. dish 16x25 cm. Sauce cups not included.**  
Incl. piatto 16x25cm. Coppette salsa escluse.



**Service dish with wooden stand**  
Piatto servire con tagliere legno  
Servierplatte mit Holzbrett  
Plat à servir avec support en bois  
Plato para servir con tabla madera

art.	cm.	Por.
44244S30	30x15	1-2
44244S36	36x24	4-6



**Hot pot with wooden stand**  
Casseroola con tagliere legno  
Schüssel mit Holzbrett  
Bol avec support en bois  
Bol con tabla madera

art.	Ø cm.	h.	lt.	Por.
44246S11	11	4	0,21	1
44246S14	14	4	0,32	1
44246S17	17	4	0,59	1

# OVEN COOKING DISHES PIROFILE FORNO

PORCELAIN  
PORCELLANA



Only use in the oven or microwave oven, do not place them on direct flame.

Per uso in forni tradizionali e microonde, non mettere le porcellane a diretto contatto con la fiamma.



**Oval dish, fluted**

Pirofila ovale cordonata  
Schale, oval, gerippt  
Plat ovale, cannelé

Fuente oval borderizata

art.	cm.
44371-24	24x14x4
44371-28	28x16x4,5
44371-32	32,5x18x5
44371-36	36,5x19,5x5
44371-40	41x23x5,5
44371-44	44x26,5x5,7
44371-48	48x28,5x6,5



**Round dish, fluted**

Pirofila rotonda cordonata  
Schale, rund, gerippt  
Plat rond, cannelé

Fuente redonda borderizata

art.	Ø cm.
44372-26	26,5
44372-32	32,0
44372-36	36,0
44372-40	40,0



**Rectangular dish, fluted**

Pirofila rettangolare cordonata  
Schale, rechteckig, gerippt  
Plat rectangulaire, cannelé

Fuente rectangular borderizata

art.	cm.
44374-22	22x16x6
44374-25	25x20x7
44374-32	32x22x6
44374-36	36x24x6
44374-40	40x26x6
44374-44	44x32x6



**Oval dish, high, fluted**

Pirofila ovale cordonata, alta  
Schale, oval, gerippt  
Plat oval, cannelé

Fuente oval borderizata, alta

art.	cm.
44389-32	32x22x8,5



**Rectangular dish, low, fluted**

Rettangolare cordonata, bassa  
Schale, rechteckig, flach, gerippt  
Plat rectangulaire, cannelé

Fuente rect. borderizata, baja

art.	cm.
44376-40	40x30x4



**Square dish, fluted**

Pirofila quadra cordonata  
Schale, quadratisch, gerippt  
Plat carré, cannelé

Fuente cuadrada borderizata

art.	cm.
44375-25	25x25x6



**Egg dish, fluted**

Tegamino cordonato  
Schale, gerippt  
Plat à oeufs, cannelé

Fuente huevo borderizata

art.	cm.
44394-18	18x21,0
44394-21	21x24,5



**Creme broulée bowl**

Coppetta creme broulée  
Crème broulée Schale  
Coupelle broulée à crème

Bol creme broulée

art.	Ø cm.	h.
44391-12	11,6	3



**Egg dish, high, fluted**

Tegamino fondo, cordonato  
Schale, tief, gerippt  
Plat oeuf, creux, cannelé

Fuente huevo borderizata, alta

art.	cm.
44395-18	18x20



**Soup bowl with cover**

Casseruola con coperchio  
Kasserolle mit Deckel  
Casserole avec couvercle  
Cacerola con tapa

art.	cm.	lt.
44397-18	14x18	0,5



**Ramekin, fluted**

Soufflé cordonato  
Ramekin, gerippt  
Ramequin, cannelé

Fuente soufflé borderizata

art.	Ø cm.	h.
44390-07	7	4,0
44390-09	9	4,5
44390-11	11	6,0



**Ramekin, fluted**

Soufflé cordonato  
Ramekin, gerippt  
Ramequin, cannelé

Fuente soufflé borderizata

art.	Ø cm.	h.
44390-15	15	5,0
44390-18	18	7,5
44390-23	23	8,0

# GN FOOD PANS CONTENITORI GN

STAINLESS STEEL, ALUMINUM, POLYCARBONATE, POLYPROPYLENE, MELAMINE AND PORCELAIN  
INOX, ALLUMINIO, POLICARBONATO, POLIPROPILENE, MELAMINA E PORCELLANA



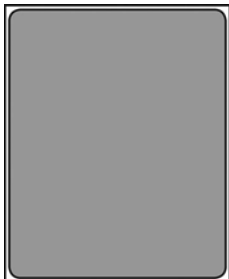

**GN-containers**

GN bacinelle  
GN-Behälter  
GN bacs  
GN cubetas



art.	GN	dim. mm.	h. mm.	lt.
14101-02	2/1	650x530	20	-
14101-04	2/1	650x530	40	-
14101-06	2/1	650x530	65	19
14101-10	2/1	650x530	100	31
14101-15	2/1	650x530	150	46
14101-20	2/1	650x530	200	56



art.	GN	dim. mm.	h. mm.	lt.
14102-02	1/1	530x325	20	-
14102-04	1/1	530x325	40	-
14102-06	1/1	530x325	65	9
14102-10	1/1	530x325	100	14
14102-15	1/1	530x325	150	21
14102-20	1/1	530x325	200	28



art.	GN	dim. mm.	h. mm.	lt.
14103-02	2/3	353x320	20	-
14103-04	2/3	353x320	40	-
14103-06	2/3	353x320	65	5,5
14103-10	2/3	353x320	100	9,0
14103-15	2/3	353x320	150	13,0
14103-20	2/3	353x320	200	18,0

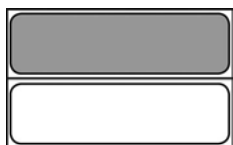

art.	GN	dim. mm.	h. mm.	lt.
14104-06	2/4	162x530	65	4,0
14104-10	2/4	162x530	100	5,6
14104-15	2/4	162x530	150	8,7



art.	GN	dim. mm.	h. mm.	lt.
14105-02	1/2	325x265	20	-
14105-04	1/2	325x265	40	-
14105-06	1/2	325x265	65	4,0
14105-10	1/2	325x265	100	6,5
14105-15	1/2	325x265	150	9,5
14105-20	1/2	325x265	200	12,5

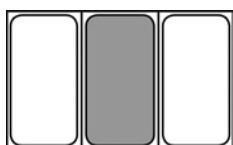

art.	GN	dim. mm.	h. mm.	lt.
14107-06	1/3	325x180	65	2,5
14107-10	1/3	325x180	100	4,0
14107-15	1/3	325x180	150	5,7
14107-20	1/3	325x180	200	7,8



art.	GN	dim. mm.	h. mm.	lt.
14108-06	1/4	265x160	65	1,8
14108-10	1/4	265x160	100	2,8
14108-15	1/4	265x160	150	4,0
14108-20	1/4	265x160	200	5,5



art.	GN	dim. mm.	h. mm.	lt.
14109-06	1/6	176x160	65	1,0
14109-10	1/6	176x160	100	1,6
14109-15	1/6	176x160	150	2,4
14109-20	1/6	176x160	200	3,4



art.	GN	dim. mm.	h. mm.	lt.
14110-06	1/9	176x110	65	0,6
14110-10	1/9	176x110	100	1,0



**GN-containers, fixed handles**

GN bacinelle, maniglie fisse  
GN-Behälter mit festen Griffen

GN bacs, anses fixes  
GN cubetas, asas fijas

art.	GN	dim. mm.	h. mm.	lt.
14112-10	1/1	530x325	100	14,0
14112-15	1/1	530x325	150	21,0
14112-20	1/1	530x325	200	28,0





art.	GN	dim. mm.	h. mm.	lt.
14115-10	1/2	325x265	100	6,5
14115-15	1/2	325x265	150	9,5
14115-20	1/2	325x265	200	12,5

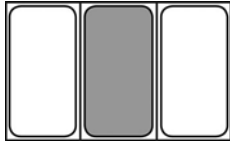

art.	GN	dim. mm.	h. mm.	lt.
14117-10	1/3	325x180	100	4,0
14117-15	1/3	325x180	150	5,7
14117-20	1/3	325x180	200	7,8



art.	GN	dim. mm.	h. mm.	lt.
14118-10	1/4	265x160	100	2,8
14118-15	1/4	265x160	150	4,0
14118-20	1/4	265x160	200	5,5



art.	GN	dim. mm.	h. mm.	lt.
14119-10	1/6	176x160	100	1,6
14119-15	1/6	176x160	150	2,4



**GN-containers, internal handles**  
GN bacinelle, maniglie interne  
GN-Behälter mit Innen Griffen  
GN bacs, anses internes  
GN cubetas, asas internas



art.	GN	dim. mm.	h. mm.	lt.
14142-10	1/1	530x325	100	14,0
14142-15	1/1	530x325	150	21,0
14142-20	1/1	530x325	200	28,0



art.	GN	dim. mm.	h. mm.	lt.
14145-10	1/2	325x265	100	6,5
14145-15	1/2	325x265	150	9,5
14145-20	1/2	325x265	200	12,5



art.	GN	dim. mm.	h. mm.	lt.
14147-10	1/3	325x180	100	4,0
14147-15	1/3	325x180	150	5,7
14147-20	1/3	325x180	200	7,8



art.	GN	dim. mm.	h. mm.	lt.
14148-10	1/4	265x160	100	2,8
14148-15	1/4	265x160	150	4,0
14148-20	1/4	265x160	200	5,5



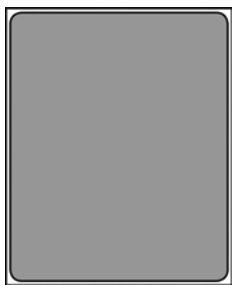

**GN-containers, falling handles**  
GN bacinelle, maniglie rientranti  
GN-Behälter mit versenkbaren Griffen  
GN bacs, anses escamotables  
GN cubetas, asas móviles



art.	GN	dim. mm.	h. mm.	lt.
14151-10	2/1	650x530	100	31,0
14151-15	2/1	650x530	150	46,0
14151-20	2/1	650x530	200	56,0



art.	GN	dim. mm.	h. mm.	lt.
14152-06	1/1	530x325	65	9,0
14152-10	1/1	530x325	100	14,0
14152-15	1/1	530x325	150	21,0
14152-20	1/1	530x325	200	28,0



art.	GN	dim. mm.	h. mm.	lt.
14155-10	1/2	325x265	100	6,5
14155-15	1/2	325x265	150	9,5
14155-20	1/2	325x265	200	12,5

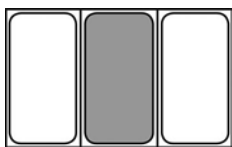

art.	GN	dim. mm.	h. mm.	lt.
14157-10	1/3	325x180	100	4,0
14157-15	1/3	325x180	150	5,7
14157-20	1/3	325x180	200	7,8



art.	GN	dim. mm.	h. mm.	lt.
14158-10	1/4	265x160	100	2,8
14158-15	1/4	265x160	150	4,0
14158-20	1/4	265x160	200	5,5



art.	GN	dim. mm.	h. mm.	lt.
14159-10	1/6	176x160	100	1,6
14159-15	1/6	176x160	150	2,4
14159-20	1/6	176x160	200	3,4



**GN-containers non stick coated**  
GN bacinelle antiaderenti  
GN-Behälter mit Antihafbeschichtung  
GN-bacs avec revêtement anti-adhésif  
GN-cubetas con cobertura antiadherente



art.	GN	dim. mm.	h. mm.
14162-02	1/1	530x325	20
14162-04	1/1	530x325	40
14162-06	1/1	530x325	65



art.	GN	dim. mm.	h. mm.
14165-02	1/2	325x265	20
14165-04	1/2	325x265	40
14165-06	1/2	325x265	65

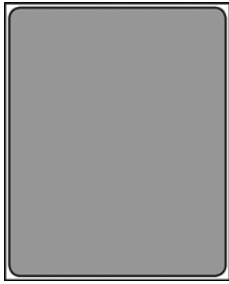

**Perforated GN-containers**

GN bacinelle forate  
Gelochte GN-Behälter  
GN bacs perforés  
GN cubetas perforados



art.	GN	dim. mm.	h. mm.
14201-02	2/1	650x530	20
14201-04	2/1	650x530	40
14201-06	2/1	650x530	65
14201-10	2/1	650x530	100
14201-15	2/1	650x530	150
14201-20	2/1	650x530	200

**Containers depth mm 20 and 40 only bottom perforated. – Bacinelle profondità mm 20 e 40 forate solo sul fondo.**



art.	GN	dim. mm.	h. mm.
14202-02	1/1	530x325	20
14202-04	1/1	530x325	40
14202-06	1/1	530x325	65
14202-10	1/1	530x325	100
14202-15	1/1	530x325	150
14202-20	1/1	530x325	200

**Containers depth mm 20 and 40 only bottom perforated. – Bacinelle profondità mm 20 e 40 forate solo sul fondo.**

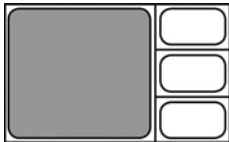

art.	GN	dim. mm.	h. mm.
14203-06	2/3	353x320	65
14203-10	2/3	353x320	100
14203-15	2/3	353x320	150
14203-20	2/3	353x320	200



art.	GN	dim. mm.	h. mm.
14205-02	1/2	325x265	20
14205-04	1/2	325x265	40
14205-06	1/2	325x265	65
14205-10	1/2	325x265	100
14205-15	1/2	325x265	150
14205-20	1/2	325x265	200

**Containers depth mm 20 and 40 only bottom perforated. – Bacinelle profondità mm 20 e 40 forate solo sul fondo.**



**Perforated GN-containers, folding handles**

GN bacinelle forate, maniglie snodate  
Gelochte GN-Behälter mit Fallgriffen  
GN bacs perforés, anses pliantes  
GN cubetas perforados, asas plegables



art.	GN	dim. mm.	h. mm.
14252-06	1/1	530x325	65
14252-10	1/1	530x325	100
14252-15	1/1	530x325	150
14252-20	1/1	530x325	200



art.	GN	dim. mm.	h. mm.
14255-06	1/2	325x265	65
14255-10	1/2	325x265	100
14255-15	1/2	325x265	150
14255-20	1/2	325x265	200



**GN-lids**

GN coperchi  
GN-Deckel  
GN couvercles  
GN tapas

art.	GN	dim. mm.
14502-00	1/1	530x325
14503-00	2/3	353x320
14504-00	2/4	162x530
14505-00	1/2	325x265
14507-00	1/3	325x180
14508-00	1/4	265x160
14509-00	1/6	176x160
14510-00	1/9	176x110



**GN-lids with notched edge for handles**

GN coperchi con spacco maniglie  
GN-Deckel mit Griffen-Ausschnitt  
GN couvercles avec encoche pour anses  
GN tapas con orificio asas

art.	GN	dim. mm.
14512-00	1/1	530x325
14515-00	1/2	325x265
14517-00	1/3	325x180
14518-00	1/4	265x160
14519-00	1/6	176x160



**GN-lids with notched edge for ladle**

GN coperchi con spacco mestolo  
GN-Deckel mit Löffel-Ausschnitt  
GN couvercles avec encoche pour louche  
GN tapas con orificio cacillo

art.	GN	dim. mm.
14522-00	1/1	530x325
14523-00	2/3	353x320
14525-00	1/2	325x265
14527-00	1/3	325x180
14528-00	1/4	265x160
14529-00	1/6	176x160



**GN-lids with notched edge for handles/ladle**

GN coperchi con spacco maniglie/mestolo  
GN-Deckel mit Griffen u. Löffel-Ausschnitt  
GN couvercles avec encoche pour anses/louche  
GN tapas con orificio asas/cacillo

art.	GN	dim. mm.
14532-00	1/1	530x325
14535-00	1/2	325x265
14537-00	1/3	325x180
14538-00	1/4	265x160
14539-00	1/6	176x160



**GN-lids with silicone seal**

GN coperchi con guarnizione silicone  
GN-Deckel mit Silikondichtung  
GN couvercles avec joint silicone  
GN tapas con junta de silicona

art.	GN	dim. mm.
14542-00	1/1	530x325
14543-00	2/3	353x320
14545-00	1/2	325x265
14547-00	1/3	325x180
14548-00	1/4	265x160
14549-00	1/6	176x160





**GN-lids with notched edge for handles and seal**  
GN coperchi con spacco maniglie e guarnizione  
GN-Deckel mit Griffen-Ausschnitt u. Silikondichtung  
GN couvercles avec encoche pour anses et joint  
GN tapas con orificio asas y junta

art.	GN	dim. mm.
14552-00	1/1	530x325
14555-00	1/2	325x265

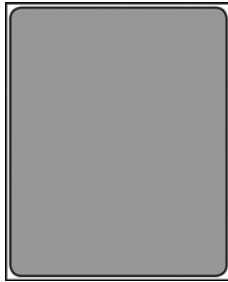

**GN-baking sheets**

GN-teglie  
GN-Backbleche  
GN-plaques  
GN-bandejas



art.	GN	dim. mm.	h. mm.
14301-02	2/1	650x530	20
14301-04	2/1	650x530	40
14301-06	2/1	650x530	65



art.	GN	dim. mm.	h. mm.
14302-02	1/1	530x325	20
14302-04	1/1	530x325	40
14302-06	1/1	530x325	65



art.	GN	dim. mm.	h. mm.
14303-02	2/3	353x320	20
14303-04	2/3	353x320	40
14303-06	2/3	353x320	65



art.	GN	dim. mm.	h. mm.
14305-02	1/2	325x265	20
14305-04	1/2	325x265	40
14305-06	1/2	325x265	65



**GN-baking sheets non stick coated**

GN-teglie con rivestimento antiaderente  
GN-Backbleche mit Antihafbeschichtung  
GN-plaques avec revêtement anti-adhésif  
GN-bandejas con cobertura antiadherente



art.	GN	dim. mm.	h. mm.
14362-02	1/1	530x325	20
14362-04	1/1	530x325	40
14362-06	1/1	530x325	65



art.	GN	dim. mm.	h. mm.
14365-02	1/2	325x265	20
14365-04	1/2	325x265	40
14365-06	1/2	325x265	65



**GN-baking sheets, ALUMINIUM**

GN-teglie, ALLUMINIO  
GN-Backbleche, ALUMINIUM  
GN-plaques, ALUMINIUM  
GN-bandejas, ALUMINIO



art.	GN	dim. mm.	h. mm.
16302-02	1/1	530x325	20
16302-04	1/1	530x325	40
16302-06	1/1	530x325	65

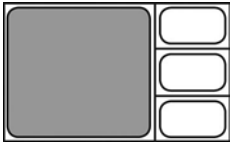

art.	GN	dim. mm.	h. mm.
16303-02	2/3	353x320	20
16303-04	2/3	353x320	40
16303-06	2/3	353x320	65



art.	GN	dim. mm.	h. mm.
16305-02	1/2	325x265	20
16305-04	1/2	325x265	40
16305-06	1/2	325x265	65



**GN-baking sheets, ALUMINIUM non stick coated**

GN-teglie, ALLUMINIO antiaderente  
GN-Backbleche, ALUMINIUM mit Antihafbeschichtung  
GN-plaques, ALUMINIUM avec revêtement anti-adhésif  
GN-bandejas, ALUMINIO con cobertura antiadherente



art.	GN	dim. mm.	h. mm.
16362-02	1/1	530x325	20
16362-04	1/1	530x325	40
16362-06	1/1	530x325	65



art.	GN	dim. mm.	h. mm.
16363-02	2/3	353x320	20
16363-04	2/3	353x320	40
16363-06	2/3	353x320	65



art.	GN	dim. mm.	h. mm.
16365-02	1/2	325x265	20
16365-04	1/2	325x265	40
16365-06	1/2	325x265	65



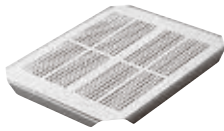

**Drainer plate**  
Falso fondo forato  
Abtropfplatte  
Plateau double fond perforé  
Fondo perforado

art.	GN
14402-00	1/1
14405-00	1/2
14407-00	1/3



**Adaptor bar**  
Separatore  
StegeAdapter/Zwischensteg  
Barrette de composition  
Adaptador

art.	GN	dim. mm.
14409-01	1/1	325
14409-02	2/1	530



**Pan, enamelled**  
Teglia smaltata  
Ofenblech, emalliert  
Bac émaillé  
Cubeta esmaltada

art.	GN	dim. mm.	h. mm.	lt.
44322-02	1/1	530x325	20	2,5
44322-04	1/1	530x325	40	5,0
44322-06	1/1	530x325	65	9,0

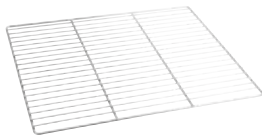

**Wire grid**  
Griglia in filo  
Gastronormrost  
Grille  
Rejilla

art.	GN	dim. mm.
44412-00	1/2	325x265
44423-00	2/3	353x320
44421-00	2/1	650x530



**Wire grid with edge**  
Griglia in filo con sponda  
Gastronormrost mit Seitenwand  
Grille avec arrêt  
Rejilla con borde

art.	GN	dim. mm.
44422-00	1/1	530x325

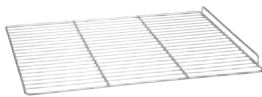

**Wire grid with edge**  
Griglia in filo con sponda  
Gastronormrost mit Seitenwand  
Grille avec arrêt  
Rejilla con borde

art.	GN	dim. mm.
44432-21	2/1	650x530



**Fry basket**  
Cesta per friggere  
Frittier-Korb  
Panier à frire  
Cesta escurrefrito

art.	GN	dim. mm.	h. mm.
11750-11	1/1	530x325	60



**Grid enamelled**  
Griglia smaltata  
Rost, emalliert  
Grille émaillé  
Rejilla esmaltada

art.	GN	dim. mm.
11760-11	1/1	530x325

# POLYCARBONATE POLICARBONATO

GN FOOD PANS  
CONTENITORI GN

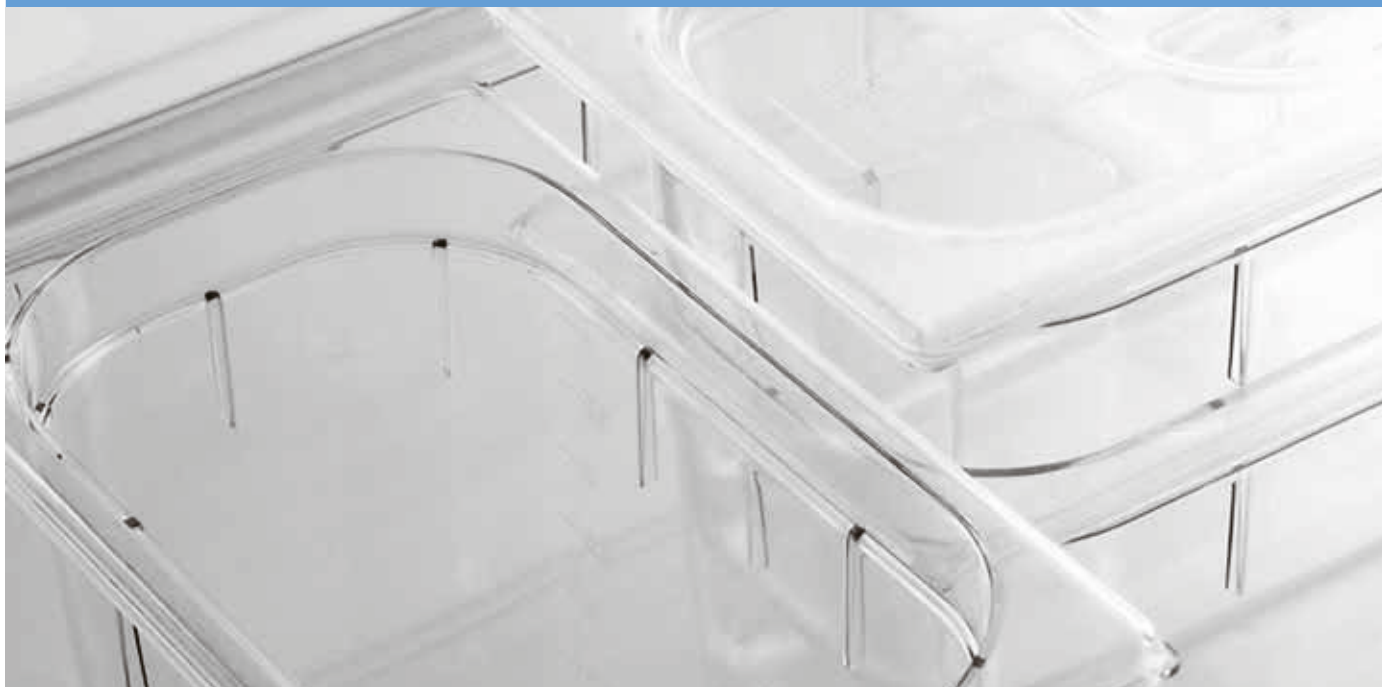

Withstands temperatures from **-40°C to +100°C**. With metric graduation. Stackable, ideal for storage, transportation and serving display.

Termoresistenti da **-40°C a +100°C**. Con scala graduata in litri. Impilabili, sono ideali per la conservazione, trasporto ed esposizione.

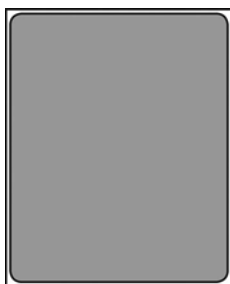

#### GN-containers

GN bacinelle  
GN-Behälter  
GN bacs  
GN cubetas

art.	GN	dim. mm.	h. mm.	lt.
14561-15	2/1	650x530	150	42
14561-20	2/1	650x530	200	52



art.	GN	dim. mm.	h. mm.	lt.
14562-06	1/1	530x325	65	8,5
14562-10	1/1	530x325	100	13,0
14562-15	1/1	530x325	150	19,5
14562-20	1/1	530x325	200	26,0



art.	GN	dim. mm.	h. mm.	lt.
14565-06	1/2	325x265	65	3,9
14565-10	1/2	325x265	100	5,9
14565-15	1/2	325x265	150	8,9
14565-20	1/2	325x265	200	11,8

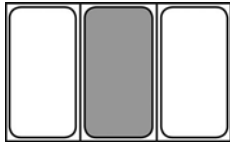

art.	GN	dim. mm.	h. mm.	lt.
14567-06	1/3	325x180	65	2,4
14567-10	1/3	325x180	100	3,6
14567-15	1/3	325x180	150	5,3
14567-20	1/3	325x180	200	7,0



art.	GN	dim. mm.	h. mm.	lt.
14568-06	1/4	265x160	65	1,7
14568-10	1/4	265x160	100	2,5
14568-15	1/4	265x160	150	3,7
14568-20	1/4	265x160	200	5,5



art.	GN	dim. mm.	h. mm.	lt.
14569-06	1/6	176x160	65	1,0
14569-10	1/6	176x160	100	1,5
14569-15	1/6	176x160	150	2,2
14569-20	1/6	176x160	200	3,4



art.	GN	dim. mm.	h. mm.	lt.
14570-06	1/9	176x110	65	0,6
14570-10	1/9	176x110	100	1,0



**GN-lid without handle**  
GN coperchio senza traversino  
GN-Deckel ohne Griff  
GN couvercle sans poignée  
GN tapa sin asa

art.	GN	dim. mm.
14571-00	2/1	650x530



**GN-lids with handle**  
GN coperchi con traversino  
GN-Deckel mit Griff  
GN couvercles avec poignée  
GN tapas con asa

art.	GN	dim. mm.
14572-00	1/1	530x325
14575-00	1/2	325x265
14577-00	1/3	325x180
14578-00	1/4	265x160
14579-00	1/6	176x160
14580-00	1/9	176x110



**GN-lid with silicone seal**  
GN coperchio con guarnizione silicone  
GN-Deckel mit Silikondichtung  
GN couvercle avec joint silicone  
GN tapa con junta de silicona

art.	GN	dim. mm.
14585-00	1/2	325x265



**Drainer plate**  
Falso fondo forato  
Abtropfplatte  
Plateau double fond perforé  
Fondo perforado

art.	GN	dim. mm.
14591-00	2/1	650x530
14592-00	1/1	530x325
14595-00	1/2	325x265
14597-00	1/3	325x180
14598-00	1/4	265x160
14599-00	1/6	176x160



# TRITAN BPA FREE

GN FOOD PANS  
CONTENITORI GN



**TRITAN - COPOLYMER - BPA FREE -40°C+90°C.**  
The lids of the series 14800 polycarbonate and 14600 Tritan are interchangeable. Hermetic lids, NOT water-tight.

**TRITAN COPOLIMERO - BPA FREE -40°C+90°C.**  
I coperchi della serie 14800 policarbonato e 14600 Tritan sono intercambiabili. Coperchi ermetici, NON a tenuta stagna.

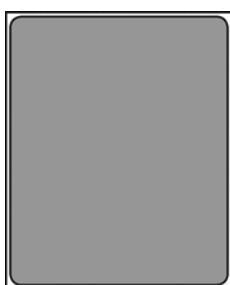

## GN-containers

GN bacinelle  
GN-Behälter  
GN bacs  
GN cubetas

art.	GN	dim. mm.	h. mm.	lt.
14661-20	2/1	650x530	200	55,5

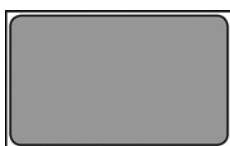

art.	GN	dim. mm.	h. mm.	lt.
14662-06	1/1	530x325	65	9,0
14662-10	1/1	530x325	100	13,3
14662-15	1/1	530x325	150	20,0
14662-20	1/1	530x325	200	26,4



art.	GN	dim. mm.	h. mm.	lt.
14665-06	1/2	325x265	65	4,0
14665-10	1/2	325x265	100	6,1
14665-15	1/2	325x265	150	9,0
14665-20	1/2	325x265	200	11,9

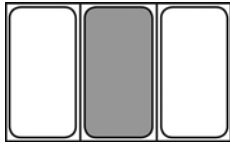

art.	GN	dim. mm.	h. mm.	lt.
14667-06	1/3	325x175	65	2,5
14667-10	1/3	325x175	100	3,8
14667-15	1/3	325x175	150	5,5
14667-20	1/3	325x175	200	7,1



art.	GN	dim. mm.	h. mm.	lt.
14668-06	1/4	264x162	65	1,7
14668-10	1/4	264x162	100	2,6
14668-15	1/4	264x162	150	3,8
14668-20	1/4	264x162	200	4,8



art.	GN	dim. mm.	h. mm.	lt.
14669-06	1/6	176x162	65	1,0
14669-10	1/6	176x162	100	1,6
14669-15	1/6	176x162	150	2,3
14669-20	1/6	176x162	200	2,8



art.	GN	dim. mm.	h. mm.	lt.
14670-06	1/9	176x108	65	0,6
14670-10	1/9	176x108	100	0,9



**GN-lids**  
GN-coperchi  
GN-Deckel  
GN couvercles  
GN tapas

art.	GN	dim. mm.
14671-00	2/1	650x530
14672-00	1/1	530x325
14675-00	1/2	325x265
14677-00	1/3	325x175
14678-00	1/4	264x162
14679-00	1/6	176x162
14680-00	1/9	176x108

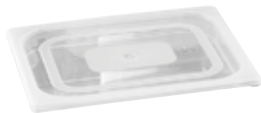

**GN-lids, hermetic**  
GN coperchi ermetici  
GN-Deckel, hermetisch  
GN couvercles hermétiques  
GN tapas herméticas

art.	GN	dim. mm.
14682-00	1/1	530x325
14685-00	1/2	325x265
14687-00	1/3	325x175
14688-00	1/4	264x162
14689-00	1/6	176x162
14690-00	1/9	176x108



**Drainer plate**  
Falso fondo forato  
Abtropfplatte  
Plateau double fond perforé  
Fondo perforado

art.	GN	dim. mm.
14691-00	2/1	650x530
14692-00	1/1	530x325
14695-00	1/2	325x265

# POLYPROPYLENE POLIPROPILENE

GN FOOD PANS  
CONTENITORI GN



Transparent and stackable. Dish-washer safe. Do not use abrasive sponges and substances. Cold resistant up to  $-40^{\circ}\text{C}$ . Heat resistant up to  $+75^{\circ}\text{C}$ . Graduation scale in liters. Lids tightly fitting.

Traslucide e impilabili. Lavabili in lavastoviglie con normali detersivi. Non utilizzare pagliette e sostanze abrasive. Termoresistenti da  $-40^{\circ}\text{C}$  a  $+75^{\circ}\text{C}$ . Scala di graduazione in litri. Coperchio resistente per una perfetta chiusura stagna.



**GN-containers**

GN bacinelle  
GN-Behälter  
GN bacs  
GN cubetas

art.	GN	dim. mm.	h. mm.	lt.
14702-06	1/1	530x325	65	8,5
14702-10	1/1	530x325	100	13,0
14702-15	1/1	530x325	150	19,5
14702-20	1/1	530x325	200	26,0



art.	GN	dim. mm.	h. mm.	lt.
14705-06	1/2	325x265	65	3,9
14705-10	1/2	325x265	100	5,9
14705-15	1/2	325x265	150	8,9
14705-20	1/2	325x265	200	11,8

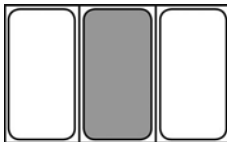

art.	GN	dim. mm.	h. mm.	lt.
14707-06	1/3	325x180	65	2,4
14707-10	1/3	325x180	100	3,6
14707-15	1/3	325x180	150	5,3
14707-20	1/3	325x180	200	7,0



art.	GN	dim. mm.	h. mm.	lt.
14708-06	1/4	265x160	65	1,7
14708-10	1/4	265x160	100	2,5
14708-15	1/4	265x160	150	3,7
14708-20	1/4	265x160	200	5,5



art.	GN	dim. mm.	h. mm.	lt.
14709-06	1/6	176x160	65	1,0
14709-10	1/6	176x160	100	1,5
14709-15	1/6	176x160	150	2,2
14709-20	1/6	176x160	200	3,4



art.	GN	dim. mm.	h. mm.	lt.
14710-06	1/9	176x110	65	1,3
14710-10	1/9	176x110	100	0,8



**Drainer plate**

Falso fondo forato  
Abtropfplatte  
Plateau double fond perforé  
Fondo perforado

art.	GN	dim. mm.	h. mm.
14712-00	1/1	471x266	16
14715-00	1/2	266x206	16
14717-00	1/3	266x117	16
14718-00	1/4	207x103	16
14719-00	1/6	117x103	16



**GN-lids**  
GN-coperchi  
GN-Deckel  
GN couvercles  
GN tapas

art.	GN	dim. mm.	col.
14722-00	1/1	530x325	●
14722-11	1/1	530x325	●
14722-22	1/1	530x325	●
14722-33	1/1	530x325	●
14722-99	1/1	530x325	○



art.	GN	dim. mm.	col.
14725-00	1/2	325x265	●
14725-11	1/2	325x265	●
14725-22	1/2	325x265	●
14725-33	1/2	325x265	●
14725-99	1/2	325x265	○



art.	GN	dim. mm.	col.
14727-00	1/3	325x180	●
14727-11	1/3	325x180	●
14727-22	1/3	325x180	●
14727-33	1/3	325x180	●
14727-99	1/3	325x180	○



art.	GN	dim. mm.	col.
14728-00	1/4	265x160	●
14728-11	1/4	265x160	●
14728-22	1/4	265x160	●
14728-33	1/4	265x160	●
14728-99	1/4	265x160	○



art.	GN	dim. mm.	col.
14729-00	1/6	176x160	●
14729-11	1/6	176x160	●
14729-22	1/6	176x160	●
14729-33	1/6	176x160	●
14729-99	1/6	176x160	○



art.	GN	dim. mm.	col.
14730-00	1/9	176x110	●
14730-11	1/9	176x110	●
14730-22	1/9	176x110	●
14730-33	1/9	176x110	●
14730-99	1/9	176x110	○

# IML POLYPROPYLENE POLIPROPILENE IML

GN FOOD PANS  
CONTENITORI GN



With permanent in molded label. To write on the label there is a specific marker that can be removed by simply washing in the dishwasher. Withstand temperatures from -40°C to +80°C. With both metric and American graduated scale. **WARNING:** polypropylene containers are not suitable for use on steam tables.

Con etichetta permanente costampata. Per scrivere sull'etichetta è disponibile un pennarello specifico che viene rimosso con il semplice lavaggio in lavastoviglie. Termoresistenti da -40°C a +80°C. Scala graduata sia secondo sistema metrico che americano. **AVVERTENZE:** i contenitori in polipropilene non sono indicati per l'uso su tavole a vapore.



**GN-containers**

GN bacinelle  
GN-Behälter  
GN bacs  
GN cubetas

art.	GN	dim. mm.	h. mm.	lt.
15101-06	1/1	530x325	65	9,0
15101-10	1/1	530x325	100	13,3
15101-15	1/1	530x325	150	20,0
15101-20	1/1	530x325	200	26,4



art.	GN	dim. mm.	h. mm.	lt.
15105-06	1/2	325x265	65	4,0
15105-10	1/2	325x265	100	6,1
15105-15	1/2	325x265	150	9,0
15105-20	1/2	325x265	200	11,9

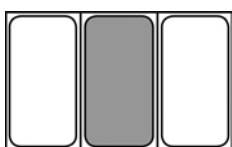

art.	GN	dim. mm.	h. mm.	lt.
15107-06	1/3	325x175	65	2,5
15107-10	1/3	325x175	100	3,8
15107-15	1/3	325x175	150	5,5
15107-20	1/3	325x175	200	7,1



art.	GN	dim. mm.	h. mm.	lt.
15108-06	1/4	264x162	65	1,7
15108-10	1/4	264x162	100	2,6
15108-15	1/4	264x162	150	3,8
15108-20	1/4	264x162	200	4,8



art.	GN	dim. mm.	h. mm.	lt.
15109-06	1/6	176x162	65	1,0
15109-10	1/6	176x162	100	1,6
15109-15	1/6	176x162	150	2,3
15109-20	1/6	176x162	200	2,8



art.	GN	dim. mm.	h. mm.	lt.
15110-06	1/9	176x108	65	0,6
15110-10	1/9	176x108	100	0,9



**Drainer plate**

Falso fondo forato  
Abtropfplatte  
Plateau double fond perforé  
Fondo perforado

art.	GN	dim. mm.
14912-00	1/1	530x325
14915-00	1/2	325x265



**GN-lids, hermetic with GASKET**

GN coperchi ermetici con GUARNIZIONE  
GN-Deckel, hermetisch mit Dichtung  
GN couvercles hermétiques avec joint  
GN tapas herméticas con junta

art.	GN	dim. mm.
14942-99	1/1	530x325
14945-99	1/2	325x265
14947-99	1/3	325x175

**NEW**



**GN-lids**  
GN coperchi  
GN-Deckel  
GN couvercles  
GN tapas

art.	GN	dim. mm.	col.
14922-00	1/1	530x325	●
14922-11	1/1	530x325	●
14922-22	1/1	530x325	●
14922-33	1/1	530x325	●
14922-77	1/1	530x325	● NEW
14922-99	1/1	530x325	○



art.	GN	dim. mm.	col.
14925-00	1/2	325x265	●
14925-11	1/2	325x265	●
14925-22	1/2	325x265	●
14925-33	1/2	325x265	●
14925-77	1/2	325x265	● NEW
14925-99	1/2	325x265	○



art.	GN	dim. mm.	col.
14927-00	1/3	325x175	●
14927-11	1/3	325x175	●
14927-22	1/3	325x175	●
14927-33	1/3	325x175	●
14927-77	1/3	325x175	● NEW
14927-99	1/3	325x175	○



art.	GN	dim. mm.	col.
14928-00	1/4	264x162	●
14928-11	1/4	264x162	●
14928-22	1/4	264x162	●
14928-33	1/4	264x162	●
14928-77	1/4	264x162	● NEW
14928-99	1/4	264x162	○



art.	GN	dim. mm.	col.
14929-00	1/6	176x162	●
14929-11	1/6	176x162	●
14929-22	1/6	176x162	●
14929-33	1/6	176x162	●
14929-77	1/6	176x162	● NEW
14929-99	1/6	176x162	○



art.	GN	dim. mm.	col.
14930-00	1/9	176x108	●
14930-11	1/9	176x108	●
14930-22	1/9	176x108	●
14930-33	1/9	176x108	●
14930-77	1/9	176x108	● NEW
14930-99	1/9	176x108	○





**Clips for lids**  
 Clips per coperchi  
 Clips für Deckel  
 Clips pour couvercles  
 Clips para tapas

art.	U. Pack	col.
15100-01	12	●
15100-02	12	●
15100-03	12	●
15100-04	12	●
15100-07	12	● NEW



**Kit 2 markers**  
 Set 2 pennarelli  
 Satz 2 Marker  
 Set 2 marqueurs  
 Juego 2 marcadores

art.  
 15100-AA

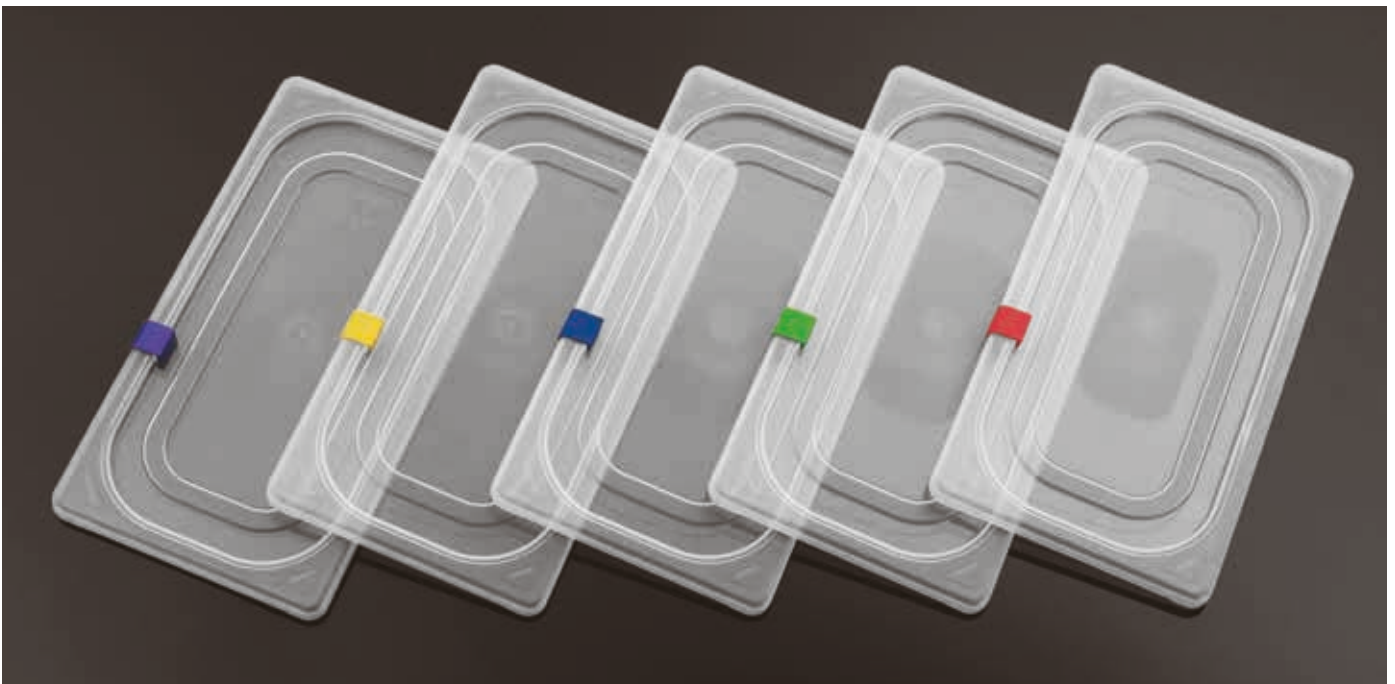



Melamine is suitable for hot and cold food use. Melamine is suitable for food storage at ambient or chilled temperatures for up to 24 hours. Melamine is not suitable for hot counters, displays, or heated cabinets. Do not expose melamine to direct flame or heat, including heat lamps and plate warmers. Temperature rating is between -20°C and 70°C (-4°F +158°F).

La melamina è adatta per l'uso sia con cibi caldi che freddi. La melamina è adatta per la conservazione degli alimenti a temperatura ambiente o refrigerata fino a 24 ore. La melamina non è adatta per piani caldi, espositori o armadi riscaldati. Non esporre a calore e fiamme dirette, incluse lampade alogene e scaldapiatti. Non esporre gli oggetti in melamina a temperature superiori a 70°C (-20°C +70°C).

GN-containers / Bacinelle / Behälter / Bacs / Cubetas



art.	GN	dim. mm.	h. mm.	lt.	col.
44877-11	1/1	530X325	65	7,1	○
44877B11	1/1	530X325	100	10,6	○
44878-11	1/1	530X325	65	7,1	●
44878B11	1/1	530X325	100	10,6	●



art.	GN	dim. mm.	h. mm.	lt.	col.
44877-24	2/4	160x530	65	3,0	○
44877B24	2/4	160x530	100	4,3	○
44878-24	2/4	160x530	65	3,0	●
44878B24	2/4	160x530	100	4,3	●



art.	GN	dim. mm.	h. mm.	lt.	col.
44877-12	1/2	325X265	65	3,4	○
44877B12	1/2	325X265	100	4,7	○
44878-12	1/2	325X265	65	3,4	●
44878B12	1/2	325X265	100	4,7	●

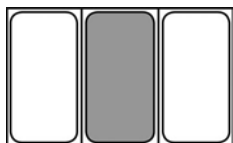

art.	GN	dim. mm.	h. mm.	lt.	col.
44877-13	1/3	325X175	65	2,0	○
44877B13	1/3	325X175	100	2,7	○
44878-13	1/3	325X175	65	2,0	●
44878B13	1/3	325X175	100	2,7	●



art.	GN	dim. mm.	h. mm.	lt.	col.
44877-14	1/4	265X160	65	1,4	○
44877B14	1/4	265X160	100	1,9	○
44878-14	1/4	265X160	65	1,4	●
44878B14	1/4	265X160	100	1,9	●



art.	GN	dim. mm.	h. mm.	lt.	col.
44877-16	1/6	175X160	65	0,8	○
44877B16	1/6	175X160	100	1,0	○
44878-16	1/6	175X160	65	0,8	●
44878B16	1/6	175X160	100	1,0	●



**GN-lids, POLICARBONATE**  
GN-coperchi, POLICARBONATO  
GN-Deckel, POLIKARBONAT  
GN couvercles, POLICARBONATE  
GN tapas, POLICARBONATO

PC

art.	GN	dim. mm.
44818-11	1/1	530X325
44818-12	1/2	325X265
44818-13	1/3	325X175
44818-14	1/4	265X160
44818-16	1/6	175X160



# PORCELAIN PORCELLANA

GN FOOD PANS  
CONTENITORI GN



## GN-containers

GN bacinelle  
GN-Behälter  
GN bacs  
GN cubetas

art.	GN	dim. mm.	h. mm.	col.
44332-03	1/1	530x325	20	○
44332-06	1/1	530x325	65	○
44382A06	1/1	530x325	65	●
44382B06	1/1	530x325	65	●
44382G06	1/1	530x325	65	●
44382O06	1/1	530x325	65	●
44382Y06	1/1	530x325	65	●
44332B06	1/1	530x325	65	●

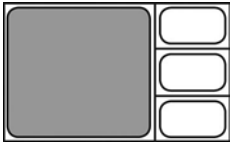

art.	GN	dim. mm.	h. mm.	col.
44333-03	2/3	353x320	20	○
44333-06	2/3	353x320	65	○
44333B06	2/3	353x320	65	●
44383O06	2/3	353x320	65	●
44383Y06	2/3	353x320	65	●

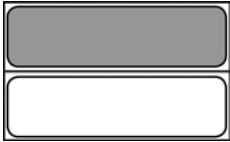

art.	GN	dim. mm.	h. mm.	col.
44334-03	2/4	162x530	20	○
44334-06	2/4	162x530	65	○
44384A06	2/4	162x530	65	●
44384O06	2/4	162x530	65	●
44384R06	2/4	162x530	65	●
44384Y06	2/4	162x530	65	●



art.	GN	dim. mm.	h. mm.	col.
44335-03	1/2	325x265	20	○
44335-06	1/2	325x265	65	○
44335B06	1/2	325x265	65	●
44385A06	1/2	325x265	65	●
44385B06	1/2	325x265	65	●
44385G06	1/2	325x265	65	●
44385O06	1/2	325x265	65	●
44385R06	1/2	325x265	65	●
44385Y06	1/2	325x265	65	●

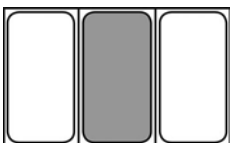

art.	GN	dim. mm.	h. mm.	col.
44337-03	1/3	325x175	20	○
44337-06	1/3	325x175	65	○
44337B06	1/3	325x175	65	●
44387A06	1/3	325x175	65	●
44387B06	1/3	325x175	65	●
44387G06	1/3	325x175	65	●
44387O06	1/3	325x175	65	●
44387R06	1/3	325x175	65	●
44387Y06	1/3	325x175	65	●



art.	GN	dim. mm.	h. mm.	col.
44338-03	1/4	265x160	20	○
44338-06	1/4	265x160	65	○



art.	GN	dim. mm.	h. mm.	col.
44339-03	1/6	176x160	20	○
44339-06	1/6	176x160	65	○

# INDUCTION PORCELAIN PORCELLANA INDUZIONE

GN FOOD PANS  
CONTENITORI GN

PR GN    INDUCTION  
READY!





**GN-containers**

GN bacinelle

GN-Behälter

GN bacs

GN cubetas

art.	GN	dim. mm.	h. mm.	col.
44342-06	1/1	530x325	65	○
44312A06	1/1	530x325	65	●
44312B06	1/1	530x325	65	●
44312G06	1/1	530x325	65	●
44312O06	1/1	530x325	65	●
44312R06	1/1	530x325	65	●
44312Y06	1/1	530x325	65	●



art.	GN	dim. mm.	h. mm.	col.
44343-06	2/3	353x320	65	○
44313B06	2/3	353x320	65	●
44313G06	2/3	353x320	65	●
44313O06	2/3	353x320	65	●
44313R06	2/3	353x320	65	●
44313Y06	2/3	353x320	65	●



art.	GN	dim. mm.	h. mm.	col.
44344-06	2/4	162x530	65	○
44314A06	2/4	162x530	65	●
44314B06	2/4	162x530	65	●
44314G06	2/4	162x530	65	●
44314O06	2/4	162x530	65	●
44314R06	2/4	162x530	65	●
44314Y06	2/4	162x530	65	●



art.	GN	dim. mm.	h. mm.	col.
44345-06	1/2	325x265	65	○
44315A06	1/2	325x265	65	●
44315B06	1/2	325x265	65	●
44315G06	1/2	325x265	65	●
44315O06	1/2	325x265	65	●
44315R06	1/2	325x265	65	●
44315Y06	1/2	325x265	65	●

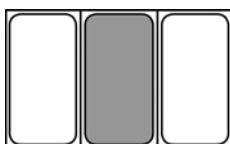

art.	GN	dim. mm.	h. mm.	col.
44347-06	1/3	325x175	65	○
44317A06	1/3	325x175	65	●
44317B06	1/3	325x175	65	●
44317G06	1/3	325x175	65	●
44317O06	1/3	325x175	65	●
44317R06	1/3	325x175	65	●
44317Y06	1/3	325x175	65	●



art.	GN	dim. mm.	h. mm.	col.
44346-06	1/4	265x160	65	○



# SERIES 12900

KITCHEN UTENSILS  
UTENSILI DA CUCINA

PA+  
plus



A wide range of professional kitchen utensils in composite material, polyamide (nylon 6.6) with fiberglass. Dishwasher safe, can be sterilized, heat resistant up to 220°C. Safe for non-stick cookware.

Un'ampia gamma di utensili professionali per la cucina in materiale composito, poliammide (nylon 6.6) con fibra di vetro. Lavabili in lavastoviglie, sterilizzabili, resistenti fino a 220°C. Ideali per l'uso con antiaderenti.





**PA+**  
plus

**Spoon**  
Cucchiaione  
Löffel  
Mouvette  
Cuchara

art.	l. cm.
12903-30	30
12903-40	38
12903-45	45



**PA+**  
plus

**Spatula**  
Spatola  
Teigschäber  
Spatule  
Espátula

art.	l. cm.
12905-25	25
12905-30	30
12905-35	35
12905-40	40
12905-45	45
12905-50	50



**PA+**  
plus

**Stirring ladle**  
Spatola per stemperare  
Rühr-u. Temperierlöffel  
Spatule à délayer  
Espátula para diluir

art.	l. cm.
12907-07	35
12907-08	35



**PA+**  
plus

**Spatula**  
Spatola  
Stielschäber  
Spatule  
Espátula

art.	l. cm.
12915-25	25
12915-26	28
12915-35	35
12915-45	45



**PA+**  
plus

**Spatula**  
Spatola  
Teigschäber  
Spatule  
Espátula

art.	l. cm.
12916-25	25
12916-33	33



**PA+**  
plus

**Spatula**  
Spatola triangolare  
Dreieck-Stielschäber  
Spatule trilon  
Espátula triangular

art.	l. cm.
12917-25	25



**PA+**  
plus

**Bevelled spatula**  
Spatola smussata  
Teigschäber  
Spatule plate biseautée  
Espátula blanda

art.	l. cm.
12906-35	35



**PA+**  
plus

**Spatula**  
Spatola  
Teigschäber  
Spatule  
Espátula

art.	l. cm.
12908-30	30
12908-35	35
12908-40	40



**PA+**  
plus

**Angular spatula**  
Paletta angolare  
Winkelpalette  
Spatule angulaire  
Espátula

art.	l. cm.
12909-12	12
12909-23	23



**PA+**  
plus

**Spatula, perforated**  
Paletta forata  
Teigschäber, perforiert  
Spatule ajourée  
Espátula perforada

art.	l. cm.
12921-01	30



**PA+**  
plus

**Spatula, perforated**  
Paletta forata  
Teigschäber, perforiert  
Spatule ajourée  
Espátula perforada

art.	l. cm.
12921-05	30



**PA+**  
plus

**Spatula**  
Paletta  
Teigschäber  
Spatule  
Espátula

art.	l. cm.
12921-10	32



**PA+**  
*plus*

**Fish & chips spatula**

Paletta fritti  
Fischheber  
Pelle à friture  
Espátula fritura

art.	l. cm.
12921-15	35



**PA+**  
*plus*

**Ladle**

Mestolo  
Schöpfplößel  
Louche  
Cacillo

art.	Ø cm.	l. cm.
12920-01	9	31



**PA+**  
*plus*

**Skimmer**

Schiumarola  
Schaumlöffel  
Ecumoire  
Espumadera

art.	Ø cm.	l. cm.
12920-05	11	35



**PA+**  
*plus*

**Spatula**

Paletta  
Teigschäber  
Spatule  
Espátula

art.	cm.	l. cm.
12920-10	9x10	35



**PA+**  
*plus*

**Fish & chips spatula**

Paletta fritti  
Fischheber  
Pelle à friture  
Espátula fritura

art.	cm.	l. cm.
12920-11	9x10	35



**PA+**  
*plus*

**Spoon**

Cucchiaione  
Giesslöffel  
Cuillère  
Cucharón

art.	l. cm.
12920-15	35



**PA+**  
*plus*

**Perforated spoon**

Cucchiaione forato  
Giesslöffel, perforiert  
Cuillère perforée  
Cucharón perforado

art.	l. cm.
12920-16	35



**PA+**  
*plus*

**Salad tong**

Molla insalata  
Salatzange  
Pince à salade  
Pinza ensalada

art.	l. cm.
12930-51	25
12930-52	32



**PA+**  
*plus*

**Bread and pastry tong**

Molla per pane e pasticceria  
Brot-/Gebäckzange  
Pince à pain et pâtisserie  
Pinza para pan y pasteleria

art.	l. cm.
12930-62	18
12930-63	23



**PA+**  
*plus*

**Serving tong**

Molla tutto servire  
Servierzange  
Pince à servir  
Pinza servir

art.	l. cm.
12930-68	20
12930-69	25



**PA+**  
*plus*

**Spaghetti tong**

Molla spaghetti  
Spaghettizange  
Pince à spaghetti  
Pinza espagueti

art.	l. cm.
12930-74	24



**PA+**  
*plus*

**Toast and pastry tong**

Molla per toast e dolci  
Toast-/Gebäckzange  
Pince à toast et tarte  
Pinza para tostadas y dulces

art.	l. cm.
12930-77	21
12930-78	25



PA+  
plus

**Meat ball plier**  
Forbice per polpette  
Fleischkugelzange  
Pince à boulettes  
Pinza albóndigas

art.	l. cm.
12931-51	17



PA+  
plus

**Quenelle plier**  
Forbice per chenelle  
Quenellezange  
Pince à quenelles  
Pinza quenelles

art.	l. cm.
12931-53	19



PA+  
plus

**Perforated ladle**  
Mestolo forato  
Schöpföffel, gelocht  
Louche perforée  
Cacillo perforado

art.	Ø cm.	l. cm.
12967-06	6,5	30
12967-10	10,0	37,5



PA+  
plus

**Ladle**  
Mestolo  
Schöpföffel  
Louche  
Cacillo

art.	Ø cm.	l. cm.
12970-06*	6,5	30,0
12970-08	8,0	33,5
12970-10	10,0	37,5
12970-12	12,0	40,0

\*With spout. – Con becco.



PA+  
plus

**Pizza ladle, flat bottom**  
Mestolo pizza, fondo piatto  
Schöpföffel  
Louche  
Cacillo

art.	Ø cm.	l. cm.
12968-10	10	27



PA+  
plus

**Ladle, short handle**  
Mestolo, manico corto  
Schöpföffel mit kurzen Stiel  
Louche, manche court  
Cacillo, mango corto

art.	Ø cm.	l. cm.
12969-10	10	27



PA+  
plus

**Ladle, short handle**  
Mestolo, manico corto  
Schöpföffel mit kurzen Stiel  
Louche, manche court  
Cacillo, mango corto

art.	Ø cm.	l. cm.
12969-06	6,5	24



PA+  
plus

**Spoon**  
Cucchiaione  
Löffel  
Cuillère  
Cuchara

art.	l. cm.
12986-38	37,5



PA+  
plus

**Spoon, short handle**  
Cucchiaione, manico corto  
Löffel mit kurzen Stiel  
Cuillère, manche court  
Cuchara, mango corto

art.	l. cm.
12986-01	23



PA+  
plus

**Skimmer**  
Schiumarola  
Schaumlöffel  
Ecumoire  
Espumadera

art.	Ø cm.	l. cm.
12971-10	10	31
12971-12	12	37



PA+  
plus

**Spatula**  
Paletta liscia  
Backschaufel  
Spatule  
Espátula lisa

art.	cm.	l. cm.
12972-10	10	36,5
12972-12	12	38,0



PA+  
plus

**Perforated spatula**  
Paletta forata  
Backschaufel, perforiert  
Spatule perforée  
Espátula perforada

art.	cm.	l. cm.
12973-10	10	36,5
12973-12	12	38



**PA+**  
plus

**Conical colander**

Colatutto tronco conico  
Gemüsesieher  
Passoire à légumes  
Colador cónico

art.	Ø cm.	h.	lt.
12950-32	32	16	8
12950-40	40	20	12



**SS**  
**PA+**  
plus

**Strainer**

Colatutto  
Sieb  
Passoire  
Colador multiuso

art.	cm.	l. cm.
12932-22	22x18,5	44
12932-26	26x21	47



**SS**  
**PA+**  
plus

**Soup strainer**

Colino a rete  
Suppensieb  
Passe-bouillon  
Colador a red

art.	Ø cm.	l. cm.
12941-07	7	12
12941-10	10	12
12941-12	12	17
12941-14	14	17
12941-16	16	17
12941-18	18	17
12941-20	20	17
12941-23	23	27
12941-26	26	27



**SS**  
**PA+**  
plus

**Wire whip, 8 silicone wires**

Frusta, 8 fili silicone  
Rührbesen, 8 Drähte aus Silikon  
Fouet, 8 fils en silicone  
Batidor, 8 varillas de siliconea

art.	l. cm.
12926-35	35



**SS**  
**PA+**  
plus

**Wire whip, 8 wires**

Frusta, 8 fili  
Rührbesen, 8 Drähte  
Fouet, 8 fils  
Batidor, 8 varillas

art.	l. cm.
12928-25	25
12928-30	30
12928-35	35
12928-40	40
12928-45	45
12928-50	50
12928-55	55
12928-60	60



**SS**  
**PA+**  
plus

**Egg whisk, 11 wires**

Frusta media, 11 fili  
Schneebeesen, 11 Drähte  
Fouet, 11 fils  
Batidor, 11 varillas

art.	l. cm.
12929-25	25
12929-30	30
12929-35	35
12929-40	40
12929-45	45

**Water-tight, dishwasher safe.**

Perfetta tenuta stagna, lavabile in lavastoviglie.



**SS**  
**PA+**  
plus

**Balloon whisk**

Frusta balloon  
Schneebeesen  
Fouet à blancs  
Batidor tipo globo

art.	l. cm.
12927-35	35
12927-45	45

**Water-tight, dishwasher safe.**

Perfetta tenuta stagna, lavabile in lavastoviglie.

# SERIES 48280 - 48278

KITCHEN UTENSILS  
UTENSILI DA CUCINA



**A wide range of professional kitchen utensils. These are essential tools to make original decorations as well as to ease the preparation of your recipes. All items are made of 18/10 stainless steel while their ergonomic handles are available both in stainless steel and Polypropylene. They are all hangable and can be cleaned in dishwasher. They boast a modern, functional design and are very easy to use.**

Un'ampia gamma di utensili professionali per la cucina, indispensabili per creare decorazioni originali e fantasiose, ma utili anche per svolgere le più semplici operazioni in modo preciso e veloce. Tutti i pezzi sono realizzati in acciaio inox 18/10, mentre la manichatura ergonomica è prevista nella versione acciaio inox o polipropilene. Tutti gli articoli sono dotati di un foro sul manico per essere appesi. Lavabili in lavastoviglie. Il design è moderno e funzionale per il massimo comfort d'utilizzo.



**Pizza knife**

Coltello per pizza  
Pizza-Messer  
Couteau à pizza  
Cuchillo pizza

art.	l. cm.
48280-45	23,5



**Pizza wheel**

Rotella taglia pizza  
Pizza-Rad  
Roulette à pizza  
Ruleta cortapizzas

art.	Ø cm.	l. cm.
18324-10	10	24



**Pastry wheel**

Rotella taglia pasta  
Teig-Rad  
Roulette à pâte  
Ruleta cortapasta

art.	Ø cm.	l. cm.
48280-32	4	18



**Double pastry wheel**

Rotella taglia pasta doppia  
Teig-Rad, doppel  
Roulette a pâte double  
Ruleta cortapasta doble

art.	Ø cm.	l. cm.
48280-39	4	18



**Vegetables knife**

Coltello verdure  
Gemüsemesser  
Couteau à crudités  
Cuchillo verduras

art.	l. cm.
48280-48	19



**Parsley knife**

Falcetta prezzemolo  
Petersilie-Wiegemesser  
Hachinette persil  
Cuchillo perejil

art.	Ø cm.	l. cm.
48280-20	11	17



**Cheese knife**

Coltello grana  
Käsemesser  
Couteau à fromage  
Cuchillo queso

art.	l. cm.
48280-04	20



**Oyster knife**

Coltello apriostriche/cozze  
Austernmesser  
Couteau à huîtres  
Cuchillo ostras

art.	l. cm.
48280-05	20,5



**Chestnut knife**

Coltello castagne  
Kastanienmesser  
Couteau à marrons  
Cuchillo castañas

art.	l. cm.
48280-21	16



**Fish scaler**

Squamapesce  
Fischentschupper  
Ecailleur à poisson  
Escamador

art.	l. cm.
48280-38	23,5



**Double fish scaler**  
Squamapesce doppio  
Fischentschupper, doppel  
Ecailleur à poisson double  
Escamador doble

art. cm.  
48280-37 22,5x3,5

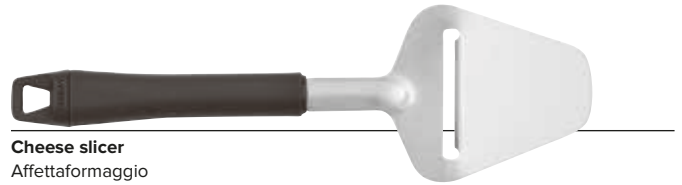

**Cheese slicer**  
Affettaformaggio  
Käsemesser  
Couteau à fromage  
Cuchillo para cortar queso

art. cm.  
48280-41 25x7,6



**Cheese cleaver**  
Mannaietta per formaggio  
Käsemesser  
Couteau à fromage  
Hacha para queso

art. cm.  
48280-49 21x4



**Cheese knife**  
Coltello formaggio  
Käsemesser  
Couteau à fromage  
Cuchillo para queso

art. l. cm.  
48280-59 27



**Parmesan knife**  
Coltello grana  
Käsemesser  
Couteau à fromage  
Cuchillo para queso parmesano

art. l. cm.  
48280-46 24



**Butter spreader**  
Spalmburro  
Butterstreicher  
Couteau à tartiner  
Cuchillo para untar

art. l. cm.  
48280-75 21,5



**Pie pan knife**  
Coltello tortiera  
Tortenring-Messer  
Couteau à manqué  
Cuchillo para tartas

art. l. cm.  
48280-22 21



**Vegetable sharpener**  
Temperino per verdure  
Gemüsefedermesser  
Taille crayon légumes  
Afilador para vegetales

art. Ø cm.  
48280-12 4,5  
48280-13 7,0



**Pastry brush, silicone**  
Pennello silicone  
Kuchenpinsel, Silikon  
Pinceau, silicone  
Pincel pastelería, silicona

art. cm.  
48280-09 25,5x4

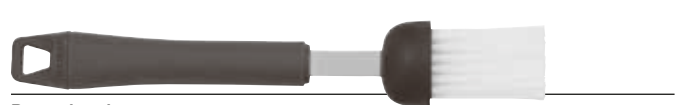

**Pastry brush**  
Pennello  
Kuchenpinsel  
Pinceau  
Pincel pastelería

art. cm.  
48280-94 22,5x3,5





**Ceddar/cheese grater**

Grattugia formaggio  
Käsereibe  
Râpe à fromage  
Rallador queso

art. l. cm.  
48280-06 24



**Bottle opener**

Apribottiglie  
Flaschenöffner  
Décapsuleur  
Abrebotellas

art. l. cm.  
48280-02 19



**Can opener**

Apriscatole  
Dosenöffner  
Ouvre boîtes  
Abrelatas

art. cm.  
48280-03 22x4,6



**Melon baller**

Scavino  
Kugelausstecher  
Cuillère parisienne  
Cortador bolas

art.	Ø cm.	l. cm.
48280-24	1,0	19,0
48280-30	1,5	19,0
48280-31	2,0	19,0
48280-35	2,3	19,5
48280-36	3,0	19,5



**Double melon baller**

Scavino doppio  
Kugelausstecher, doppel  
Cuillère parisienne, double  
Cortador bolas, doble

art. Ø cm. l. cm.  
48286-67 2,2-3,0 17



**Oval melon baller**

Scavino ovale  
Kugelausstecher, oval  
Moule à pommes, ovale  
Cortador oval

art. Ø cm. l. cm.  
48280-26 1,9 19,5



**Zucchini corer, dented**

Scavazucchine, seghettato  
Gemüseausstecher  
Vide-courgettes  
Vaciador de zucchini

art. l. cm.  
48280-54 24,5



**Pineapple coring tool**

Svuota ananas  
Ananasausstecher  
Vide ananas  
Vacía corazón piña

art. l. cm.  
48280-10 25





**Asparagus peeler**  
Pelaspargagi  
Spargelschäler  
Eplucheur à asperges  
Pelador de espárrago

art. l. cm.  
48280-85 23,5



**Tomato peeler**  
Pelapomodori  
Tomatenschäler  
Eplucheur à tomates  
Pelador de tomates

art. l. cm.  
48280-08 18



**Y-shaped swivel peeler**  
Sbucciatore a Y  
Pendelschäler  
Eplucheur  
Pelador forma Y

art. l. cm.  
48280-53 18,5  
48280-52 21,0



**Melon peeler**  
Sbuccia melone  
Melonenschäler  
Eplucheur à melon  
Pelador de melon

art. Ø cm. l. cm.  
48280-60 8,0 20  
48280-61 9,0 21  
48280-62 10,5 22  
48280-63 12,0 23



**Potato peeler**  
Pelapatate  
Sparschäler  
Eplucheur  
Pelador de patatas

art. l. cm.  
48280-34 19,5



**Orange peeler**  
Pelarance  
Orangenschäler  
Eplucheur à oranges  
Pelador de naranjas

art. l. cm.  
48280-96 20



**Grapefruit knife**  
Coltello per pompelmo  
Grapefruitmesser  
Couteau à pamplemousse  
Cuchillo para pomelo

art. l. cm.  
48280-47 21,5



**Citrus knife**  
Coltello agrumi  
Zitrus-Messer  
Couteau à agrumes  
Cuchillo para cítricos

art. l. cm.  
48280-97 23



**Fruit scoop**  
Porzionatore macedonia  
Fruchtportionierer  
Cuiller à fruits  
Raciondor de ensalada de frutas

art. l. cm.  
48280-15 20



**Butter curler**  
Arricciaburro  
Butter Lockenwickler  
Coquilleur à beurre  
Rizador de mantequilla

art. l. cm.  
48280-11 22,5





**Fruit decorating knife**

Coltello decora frutta  
Dekoriermesser  
Denteleur  
Cuchillo para decorar fruta

art. l. cm.  
48280-91 23



**Decorator**

Decoratore  
Ziseliermesser  
Canneleur  
Decorador

art. l. cm.  
48280-95 16,5



**Lemon striper**

Decora limoni  
Zesteur  
Canneleur  
Decorador de limones

art. l. cm.  
48280-92 17



**Lemon striper**

Rigalimoni  
Zesteur  
Canneleur  
Acanalar de limones

art. l. cm.  
48280-90 17



**Apple corer**

Levatorsoli  
Entkerner  
Vide-pommes  
Descorazonador

art. Ø cm. l. cm.  
48280-25 1,2 21



**Vegetable cutter**

Tagliaverdure ondulato  
Wellenschneider  
Découpoir à lame ondulée  
Cortador de verduras ondulado

art. l. cm.  
48280-23 11,5

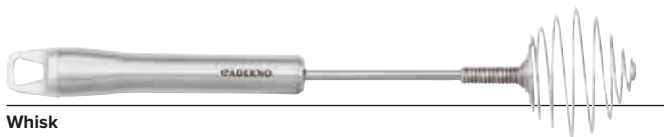

**Whisk**

Frusta  
Rührbesen  
Fouet  
Batidor

art. Ø cm. l. cm.  
48278-24 5 26,5



**Pizza wheel**

Rotella taglia pizza  
Pizza-Rad  
Roulette à pizza  
Ruleta cortapizzas

art. Ø cm. l. cm.  
48278-33 7 21



**Pastry wheel**

Rotella taglia pasta  
Teig-Rad  
Roulette à pâte  
Ruleta cortapasta

art. Ø cm. l. cm.  
48278-32 4 18



**Double pastry wheel**

Rotella taglia pasta doppia  
Teig-Rad, doppel  
Roulette à pâte double  
Ruleta cortapasta doble

art. Ø cm. l. cm.  
48278-39 4 18



**Fish scaler**

Squamapesce  
Fischentschupper  
Ecailleur à poisson  
Escamador

art.	l. cm.
48278-38	22



**Paring knife**

Spelucchino  
Spickmesser  
Couteau d'office  
Cuchillo moldeador

art.	l. cm.
48278-55	22,5



**Conical colander**

Colino conico  
Suppensieb  
Passe-bouillon  
Colador cónico

art.	Ø cm.	l. cm.
48278-13	16	35



**Soup strainer**

Colino  
Suppensieb  
Passe-bouillon  
Colador

art.	Ø cm.	l. cm.
48278-12	8	27



**Vegetables knife**

Coltello verdure  
Gemüsemesser  
Couteau à crudités  
Cuchillo de verduras

art.	l. cm.
48278-48	19



**Cheese slicer**

Affettaformaggio tenero  
Käsemesser  
Couteau à fromage  
Cortador de queso suave

art.	cm.
48278-42	20x7,5



**Cheese cleaver**

Mannaietta per formaggio  
Käsemesser  
Coutau à fromage  
Hachita para queso

art.	cm.
48278-49	21x4



**Cheese knife**

Coltello parmigiano  
Käsemesser  
Coutau à fromage  
Cuchillo para queso

art.	l. cm.
48278-46	23,5



**Cheese slicer**

Affettaformaggio  
Käseibe  
Couteau à fromage  
Cortador de queso

art.	l. cm.
48278-41	25



**Potato masher**

Pressapatate  
Kartoffelpresse  
Presse-purée  
Prensador de patatas

art.	cm.	l. cm.
48278-87	8x7	27



**Potato masher**  
Pressapatate  
Kartoffelpresse  
Presse-purée  
Prensador de patatas

art. cm.  
48278-31 27x8



**Butter spreader**  
Spalmaburro  
Buttermesser  
Couteau à beurre  
Cuchillo mantequilla

art. l. cm.  
48278-75 21



**Grater**  
Grattugia  
Reibe  
Râpe  
Rallador

art. cm.  
48278-20 25,5x5,5



**Grater**  
Grattugia  
Reibe  
Râpe  
Rallador

art. cm.  
48278-21 25,5x5,5



**Oyster/cheese knife**  
Coltello apriostriche/grana  
Austern-/Käsemesser  
Couteau à huîtres/fromage  
Cuchillo para ostras/queso

art. l. cm.  
48278-45 20



**Spatula**  
Spatola per glassa  
Palette  
Spatule  
Espátula

art. l. cm.  
48278-77 27,5



**Pastry brush**  
Pennello pasticceria  
Kuchenpinsel  
Pinceau à cuisine  
Pincel pastelería

art. l. cm.  
48278-94 22



**Garlic press**  
Spremiaglio  
Knoblauchpresse  
Presse-ail  
Prensador de ajo

art. cm.  
48278-37 19x5

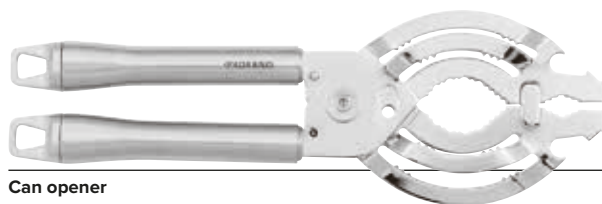

**Can opener**  
Apribarattoli  
Deckelöffner  
Ouvre-boîtes  
Abrelatas

art. cm.  
48278-01 25,5x8,5



**Bottle opener**  
Apribottiglie  
Flaschenöffner  
Ouvre-bouteilles  
Abrebotellas

art. cm.  
48278-02 19x3,7



**Can opener**

Apriscatole  
Dosenöffner  
Ouvre-boîtes  
Abrelatas

art. cm.  
48278-03 22x4,6



**Potato peeler**

Pelapatate  
Kartoffelschäler  
Eplucheur  
Pelador de patatas

art. l. cm.  
48278-34 19,5



**Melon baller**

Scavino sferico  
Kugelausstecher  
Moule à pommes  
Vaciador

art. Ø cm. l. cm.  
48278-35 3 18



**Orange peeler**

Pelarence  
Orangenschäler  
Eplucheur à pamplemousse  
Pelador de naranja

art. l. cm.  
48278-96 20



**Grapefruit knife**

Coltello per pompelmo  
Orangenschäler  
Couteau à pamplemousse  
Cuchillo para pomelo

art. l. cm.  
48278-47 21,5



**Ice cream scoop**

Porzionatore gelato  
Eisportionierer  
Cuillère à glace  
Racionador de helado

art. Ø cm. l. cm.  
48278-95 4 21



**Zucchini corer, dented**

Scavazucchine, seghettato  
Gemüseausstecher  
Vide-courgettes  
Vaciador de zucchini, dentado

art. l. cm.  
48278-54 25



**Swivel peeler**

Sbucciatore a lama mobile  
Pendelschäler  
Eplucheur  
Pelador a cuchilla mobile

art. l. cm.  
48278-52 21



**Y-shaped swivel peeler**

Sbucciatore a Y  
Pendelschäler  
Eplucheur  
Pelador forma Y

art. l. cm.  
48278-53 18,5



**Apple corer**

Levatoroli  
Entkerner  
Vide-pomme  
Descorazonador

art. Ø cm. l. cm.  
48278-25 1,6 21,5



**Potato fork**

Forchettina 3 punte  
Gabelchän  
Petite fourchette  
Tenedor tre puntas

art. l. cm.  
48278-17 16,5



**Coffee measuring spoon**

Dosa caffè  
Maßlöffel  
Cuillère à mesure  
Porcionador de café

art. Ø cm. l. cm.  
48278-16 3,5 20





**Egg separator**

Separauova  
Eier-Trenner  
Sépare oeufs  
Separador de huevos

art. Ø cm. l. cm.  
48278-36 5,5 20,5



**Decorating knife**

Coltello decora frutta  
Dekoriermesser  
Couteau à décorer  
Cuchillo para decorar frutas

art. l. cm.  
48278-91 22,5



**Cocktail spoon**

Cucchiaio cocktail  
Cocktailöffel  
Cuiller à cocktail  
Cuchara cóctel

art. Ø cm. l. cm.  
48278-15 6 28



**Lemon striper**

Decora limoni  
Zesteur  
Canneleur  
Decorador de limones

art. l. cm.  
48278-92 16,5



**Butter curler**

Arricciaburro  
Buttermesser  
Couteau à beurre  
Ruzador de mantequilla

art. l. cm.  
48278-11 21,5



**Smell-remover soap**

Saponetta togli odori  
Geruchentferner-Seife  
Savonette enlève odeurs  
Jabon quita odores

art. cm.  
48278-99 7,5x5,5



**Sauce ladle**

Mestolino salsa  
Saucenlöffel  
Louche à sauce  
Cacillo salsa

art. Ø cm. l. cm.  
48278-68 7 29



**Ladle**

Mestolo  
Schöpflöffel  
Louche  
Cazo

art. Ø cm. l. cm.  
48278-69 9 32  
48278-66 6 29



**Salad fork**

Forchetta insalata  
Saltgabel  
Fourchette à salade  
Tenedor para ensaladas

art. Ø cm. l. cm.  
48278-64 5 25,5



**Salad spoon**  
Cucchiaio insalata  
Salatlöffel  
Cuiller à salade  
Cuchara para ensaladas

art.	Ø cm.	l. cm.
48278-62	5	25



**Perforated spoon**  
Cucchiaio forato  
Giesslöffel, perforiert  
Cuiller perforé  
Cuchara perforada

art.	cm.
48278-61	34x6



**Slotted turner**  
Paletta forata  
Küchenwender  
Pelle ajourée  
Espátula perforada

art.	cm.
48278-71	34,5x8,5

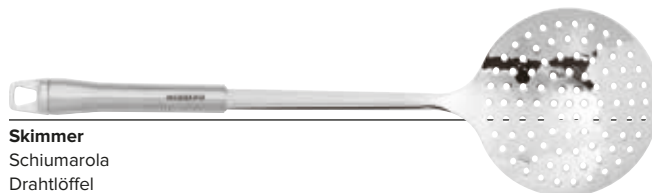

**Skimmer**  
Schiumarola  
Drahtlöffel  
Ecumoir  
Espumadera

art.	Ø cm.	l. cm.
48278-73	11	37

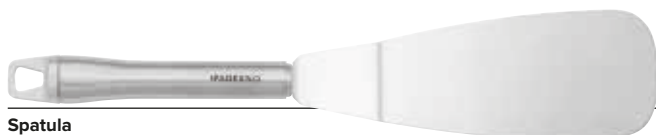

**Spatula**  
Spatola  
Palette  
Spatule  
Espátula

art.	cm.
48278-76	28,5x5,6



**Pie server**  
Pala torta  
Tortenheber  
Pelle à gâteau  
Paleta para tartas

art.	cm.
48278-93	26x5,8

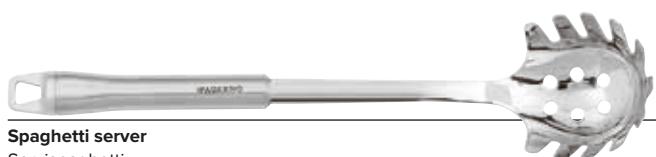

**Spaghetti server**  
Servispaghetti  
Spaghettilöffel  
Cuiller à spaghetti  
Servidor para espagueti

art.	Ø cm.	l. cm.
48278-74	7	30,5



**Fork**  
Forchettone  
Gabel  
Fourchette  
Tenedor

art.	l. cm.
48278-65	32,5



**Rice spoon**  
Cucchiaio risotto  
Reislöffel  
Rice spoon  
Cuchara para risotto

art.	l. cm.
48278-63	27



**Lasagne spatula**  
Pala pasticcio  
Palette  
Pelle  
Pala para pastel

art.	cm.
48278-27	29x4,5



**Skimmer**  
Schiumarola  
Drahtlöffel  
Ecumoir  
Espumadera

art.	Ø cm.	l. cm.
48278-88	11	36,5



**Ladle**  
Mestolo  
Schöpflöffel  
Louche  
Cazo

art.	Ø cm.	l. cm.
48278-84	9,5	32,5



**Rice spoon**  
Cucchiaio riso  
Giesslöffel  
Cuiller  
Cuchara

art.	cm.
48278-82	33x6,5



**Perforated spoon**  
Cucchiaio forato  
Giesslöffel, perforiert  
Cuiller ajouré  
Cuchara perforada

art.	cm.
48278-81	33x6,5



**Spaghetti server**  
Servispaghetti  
Spaghettillöffel  
Cuiller à spaghetti  
Servidor para espagueti

art.	cm.
48278-89	32x6,5



**Meat fork**  
Forchettone  
Gabel  
Fourchette  
Tenedor

art.	l. cm.
48278-83	32,5



**Silicone spoon**  
Cucchiaio silicone  
Löffel aus Silikon  
Cuiller en silicone  
Cucharón de silicona

art.	cm.	l. cm.
48278-14	5,5x8	26,5



**Perforated turner**  
Paletta forata  
Küchenwender, perforiert  
Pelle ajourée  
Pala perforada

art.	cm.
48278-85	33x8,5



**Silicone turner**  
Paletta silicone  
Palette aus Silikon  
Pelle en silicone  
Paleta de silicona

art.	cm.	l. cm.
48278-28	5x9	28,5



**Whisk**  
Frusta  
Rührbesen  
Fouet  
Batidor

art.	l. cm.
48278-18	24,5
48278-19	29,5



# TURNERS SPATOLE

KITCHEN UTENSILS  
UTENSILI DA CUCINA

SS PP



Stainless steel turners with polypropylene handle.

Spatole in acciaio inox con manico in polipropilene.



#### Perforated spatula

Paletta forata  
Kuchenpalette, geschlitzt  
Palette perforée  
Paleta perforada

art. cm.  
18510-07 13,5x7



#### Perforated spatula

Spatola forata  
Kuchenpalette, geschlitzt  
Palette perforée  
Paleta perforada

art. cm.  
18509-01 16x7,5  
18509-02 15,6x5



#### Perforated spatula, flexible

Paletta forata, flessibile  
Palette, geschlitzt, flexibel  
Palette perforée, flexible  
Paleta perforada, flexible

art. cm.  
18509-03 15,6x8,7



**Pizza turner**

Spatola per pasticcio e pizza  
Pizzawender  
Palette à pizza  
Espátula pizza

art. cm.  
18511-15 15,5x8,7



**Hamburger turner**

Spatola hamburger  
Hamburgerspachtel  
Palette à hamburger  
Espátula hamburger

art. cm.  
18512-15 19x13,8



**Lasagne spatula**

Spatola lasagne  
Lasagneheber  
Palette à lasagne  
Espátula lasagna

art. cm.  
18515-16 16,8x7,2



**Cleaning spatula**

Spatola triangolare  
Bratenspachtel  
Spatule  
Espátula triangular

art. cm.  
18520-04 12x4  
18520-06 12x6  
18520-08 12x8  
18520-10 12x10  
18520-12 12x12



**Hamburger turner**

Spatola hamburger  
Bratenwender  
Grand palette  
Espátula hamburger

art. cm.  
18516-24 24x7,2



**Perforated hamburger turner**

Spatola hamburger, forata  
Bratenspachtel, gelocht,  
Grand palette perforée  
Espátula hamburger, perforada

art. cm.  
18517-24 24x7,2



**Angular spatula**

Spatola cuoco con scalino  
Confiseriepalette  
Palette coudée  
Espátula chef angular

art. cm.  
18518-22 22x3,4  
18518-26 25x3,7  
18518-30 30x4,3



**Spatula**

Spatola cuoco  
Palette  
Palette  
Espátula chef

art. cm.  
18519-15 15,5x3  
18519-22 22x3,4  
18519-26 26x3,7  
18519-30 31x4,3  
18519-35 36x5



**Pastry spatula**

Paletta dolci  
Gebäckpalette  
Palette à gâteau  
Pala pasteles

art. cm.  
18513-14 14,5x6,5



**Pastry spatula**

Spatola dolce  
Kuchenpalette  
Palette à pâtissier  
Espátula dulces

art. cm.  
18514-17 16,3x5,8



**Pie knife**

Coltello torta  
Tortenmesser  
Couteau à gâteau  
Cuchillo pasteles

art. cm.  
18514-18 17,3x5,8



**Farinata knife**

Coltello per farinata  
Farinata Messer  
Couteau à farinata  
Cuchillo farinata

art. l. cm.  
42830-08 8

# LADLES MESTOLI

KITCHEN UTENSILS  
UTENSILI DA CUCINA



**The PADERNO ladle.**  
Handle-cup connection (one piece ladle). Thicker handle with rounded border.  
Diameter and capacity stamped on the handle.

**Il mestolo PADERNO.**  
Accoppiamento manico-coppa (mestolo unipezzo). Manico con spessore maggiorato  
con bordi arrotondati. Indicazione sul manico del diametro e della capacità.



**One piece ladle**  
Mestolo unipezzo  
Schöpflöffel, fugenlos  
Louche monobloc  
Cacillo monobloc

art.	Ø cm.	l. cm.	lt.
11970-06	6,5	30	0,07
11970-08	8,0	32	0,12
11970-09	9,0	33	0,20
11970-10	10,0	37	0,25
11970-11	11,0	38	0,33
11970-12	12,0	40	0,50
11970-14	14,0	44	0,75
11970-16	16,0	47	1,00



**Ladle, tube handle**  
Mestolo con manico a tubo  
Schöpflöffel mit Rohrstiel  
Louche avec manche tubulaire  
Cacillo con mango tubolar

art.	Ø cm.	l. cm.	lt.
11968-18	18	75	1,5
11968-20	20	75	2,0
11968-24	24	75	4,0



**One piece perforated ladle**  
Mestolo forato unipezzo  
Gelochter Schöpflöffel, fugenlos  
Louche monobloc perforée  
Cacillo monobloc perforado

art.	Ø cm.	l. cm.	lt.
11967-06	7	30	0,07
11967-08	8	32	0,12
11967-09	9	33	0,20
11967-10	10	37	0,25
11967-12	12	40	0,50
11967-14	14	44	0,75
11967-16	16	47	1,00



**Perforated ladle, tube handle**  
Mestolo forato con manico a tubo  
Schöpflöffel, gelocht mit Rohrstiel  
Louche perforée, manche tubulaire  
Cacillo perforado mango tubolar

art.	Ø cm.	l. cm.	lt.
11967-18	18	75	1,5
11967-20	20	75	2,0
11967-24	24	75	4,0



**One piece side basting spoon**  
Mestolo becco a versare unipezzo  
Saucenkelle quer, fugenlos  
Cuillère à arroser monobloc  
Cacillo monobloc para versar

art.	Ø cm.	l. cm.	lt.
11969-06	6,5	30	0,07
11969-37*	6,5	30	0,07

\*Left handed. – Per mancini.



**One piece basting spoon**  
Cucchiaione unipezzo  
Giesslöffel, fugenlos  
Cuillère monobloc  
Cucharón monobloc

art.	l. cm.
11982-38	38



**One piece perforated spoon**  
Cucchiaione forato unipezzo  
Giesslöffel perforiert, fugenlos  
Cuillère perforée monobloc  
Cucharón perforado monobloc

art.	l. cm.
11984-38	38



**One piece spoon, crosswise**  
Cucchiaione obliquo unipezzo  
Giesslöffel quer, fugenlos  
Cuillère oblique monobloc  
Cucharón obliquo monobloc

art.	l. cm.
11983-38	38
11983-37*	38

\*Left handed. – Per mancini.



**One piece meat fork, 3 prongs**  
Forchettone 3 denti unipezzo  
Fleischgabel 3 Zacken, fugenlos  
Fourchette 3 dents, monobloc  
Tenedor 3 dientes, monobloc

art.	l. cm.
11974-50	50
11974-70	70



NSF  
SS

**One piece meat fork, 2 prongs**  
Forchettone 2 denti unipezzo  
Fleischgabel 2 Zacken, fugenlos  
Fourchette 2 dents, monobloc  
Tenedor 2 dientes, monobloc

art.	l. cm.
11975-50	50
11975-99	100



NSF  
SS

**One piece spatula**  
Paletta liscia unipezzo  
Backschaufel, fugenlos  
Spatule monobloc  
Espátula lisa monobloc

art.	cm.	l. cm.
11972-10	10	36
11972-12	12	39



NSF  
SS

**One piece perforated spatula**  
Paletta forata unipezzo  
Backschaufel perforiert, fugenlos  
Spatule perforée monobloc  
Espátula perforada monobloc

art.	cm.	l. cm.
11973-10	10	36
11973-12	12	39



NSF  
SS

**Perforated slice**  
Pala a ridurre  
Reduzierspatel  
Spatule à réduire  
Espátula para reducir

art.	cm.	l. cm.
11976-50	12x15	50
11976-99	12x15	100



NSF  
SS

**One piece fish spatula**  
Paletta pesce unipezzo, forata  
Fischwender, fugenlos  
Pelle à poisson monobloc  
Pala pescado, monobloc

art.	cm.	l. cm.
11985-34	15x20	42



NSF  
SS

**One piece skimmer**  
Schiumarola unipezzo  
Schaumlöffel, fugenlos  
Ecumoire monobloc  
Espumadera monobloc

art.	Ø cm.	l. cm.
11971-08	8	29,0
11971-10	10	32,0
11971-12	12	35,0
11971-14	14	38,0
11971-16	16	41,0
11971-18	18	42,5
11971-20	20	44,5



NSF  
SS

**One piece skimmer, tube handle**  
Schiumarola unipezzo, manico a tubo  
Schaumlöffel, fugenlos, mit Rohrstiel  
Ecumoire monobloc, manche tubulaire  
Espumadera monobloc, mango tubolar

art.	Ø cm.	l. cm.
11971-25	25	75



NSF  
SS

**One piece ladle**  
Mestolo unipezzo  
Schöpföffel, fugenlos  
Louche monobloc  
Cacillo monobloc

art.	Ø cm.	l. cm.	lt.
11970-01	8	23	0,12

Short handle. – Manico corto.



NSF  
SS

**Side basting spoon**  
Mestolo con becco a versare  
Saucenkelle mit seitlichem Ausguß  
Cuillère à arroser  
Cacillo para versar

art.	Ø cm.	l. cm.	lt.
11969-02	6,5	23	0,07

Short handle. – Manico corto.



NSF  
SS

**One piece spoon**  
Cucchiaione unipezzo  
Gießlöffel, fugenlos  
Cuillère monobloc  
Cuchara monobloc

art.	l. cm.
11982-01	23,5

Short handle. – Manico corto.



NSF  
SS

**One piece meat fork**  
Forchettone unipezzo  
Fleischgabel, fugenlos  
Fourchette monobloc  
Tenedor monobloc

art.	l. cm.
11975-01	26

Short handle. – Manico corto.



NSF  
SS

**One piece perforated spatula**  
Paletta forata unipezzo  
Backschaufel perforiert, fugenlos  
Spatule perforée monobloc  
Espátula perforada monobloc

art.	cm.	l. cm.
11973-01	8x9,5	24

Short handle. – Manico corto.



NSF  
SS

**One piece skimmer**  
Schiumarola unipezzo  
Schaumlöffel, fugenlos  
Ecumoire monobloc  
Espumadera monobloc

art. Ø cm. l. cm.  
11971-01 9 26

**Short handle. – Manico corto.**



SS

**Ladle**  
Mestolo  
Schöpflöffel  
Louche  
Cacillo

art. Ø cm. l. cm. lt.  
41670-06 6 30 0,03  
41670-09 9 32 0,13



SS

**Skimmer**  
Schiumarola  
Schaumlöffel  
Ecumoire  
Espumadera

art. Ø cm. l. cm.  
41671-11 11 32



SS

**Slotted turner**  
Paletta forata  
Küchenwender, geschlitzt  
Pelle ajourée  
Espátula perforada

art. l. cm.  
41672-00 32



SS

**Spaghetti spoon**  
Cucchiaio per spaghetti  
Spaghettilöffel  
Cuillère à spaghetti  
Tenedor espaguetis

art. l. cm.  
41673-00 32



SS

**Meat fork**  
Forchettone  
Fleischgabel  
Fourchette  
Tenedor

art. l. cm.  
41674-00 32



SS

**Basting spoon**  
Cucchiaione  
Giesslöffel  
Cuillère  
Cuchara

art. l. cm.  
41675-00 32



SS

**Perforated spoon**  
Cucchiaione forato  
Schöpfkelle, gelocht  
Cuillère percée  
Cuchara perforada

art. l. cm.  
41676-00 32



SS

**Sauce ladle**  
Cucchiaione salse  
Saucenkelle  
Cuillère à sauce  
Cuchara salsas

art. l. cm.  
41677-00 32



SS

**Whisk**  
Frusta  
Schneebesen  
Fouet  
Batidor

art. l. cm.  
41678-00 30



SS

**Wall rack**  
Asta  
Aufhängungstange  
Tringle de cuisine  
Asta para utensilios

art. l. cm.  
41670-AA 40  
41670-AB 60



SS

**Mesh skimmer**  
Schiumarola a rete stirata  
Schaumlöffel  
Ecumoire  
Espumadera

art. Ø cm. l. cm.  
11990-16 16 40



SS

**Mesh skimmer**  
Schiumarola a rete passabrodo  
Schaumlöffel  
Ecumoire  
Espumadera

art. Ø cm. l. cm.  
11991-16 16 40



SS

**Bird nest fryer**  
Colafritto  
Nestbacklöffel  
Nid à friture  
Molde nido

art. Ø cm. l. cm.  
42623-10 10 26



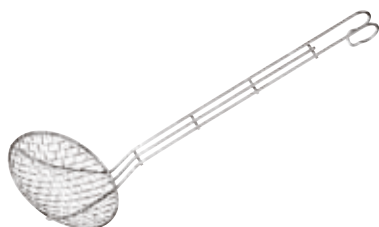

SS

**Wire skimmer**  
Schiumarola a filo  
Drahtlöffel  
Araignée  
Araña

art.	Ø cm.	l. cm.
12640-14	14	40
12640-16	16	40
12640-18	18	40
12640-20	20	50
12640-24	24	50
12640-28	28	50

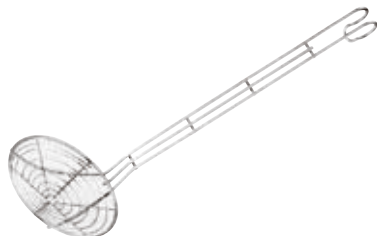

SS

**Wire skimmer**  
Schiumarola a filo  
Drahtlöffel  
Araignée  
Araña

art.	Ø cm.	l. cm.
12641-14	14	40
12641-16	16	40
12641-18	18	40
12641-20	20	50
12641-24	24	50
12641-28	28	50

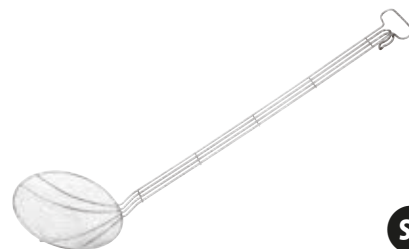

SS

**Wire skimmer**  
Schiumarola a filo  
Drahtlöffel  
Araignée  
Araña

art.	Ø cm.	l. cm.
12642-28	28	85



SS

**French fry scoop**  
Pala per patate fritte  
Frittenschaufel  
Pelle à frites  
Pala chips

art.	cm.
41929-00	20x23



ABS

**French fry scoop**  
Pala per patate fritte  
Frittenschaufel  
Pelle à frites  
Pala chips

art.
41929-02

Ambidextrous. – Ambidestro.



W

**Spatula**  
Spatola  
Schäber  
Spatule  
Espátula

art.	l. cm.
42907-01	25
42907-02	30
42907-03	35
42907-04	40
42907-06	50
42907-07	60
42907-08	80
42907-09	100
42907-10	120



W

**Mixing spoon**  
Cucchiaione  
Löffel  
Cuillère  
Cuchara

art.	l. cm.
42901-20	20
42901-25	25
42901-30	30
42901-35	35
42901-40	40



W

**Spatula**  
Spatola  
Schäber  
Spatule  
Espátula

art.	l. cm.
42907-30	30
42907-35	35
42907-40	40



W

**Crepe spreader, 5 pcs**  
Spatole crêpes, 5 pz  
Crêpe-Paletten, 5 Stk  
Rateau à crêpes/raclettes, 5 pcs  
Espátula crêpes, 5 pz

art.	cm.
42900-15	18x18
42900-24	18x24

Beachwood. – Faggio.

**NEW**

**SS**

**PP**

**PS**



**SS**

**Baster tube**

Pompetta per sugo  
Soft-Spritzze  
Pompe à jus  
Bomba para jugo

art.	l. cm.
42863-00	20



**Marinating syringe, graduated**

Siringa per marinata, graduata  
Marinierspritze, graduert  
Seringue à marinade, graduée  
Jeringa para marinar, graduada

art.	Ø cm.	l. cm.	ml.
42862-00	3,5	24	30



**SS**

**Fish-bone remover**

Pinza togli lische  
Grätenentkerner  
Pince à arêtes  
Pinza para espinas

art.	l. cm.
42592-01	12
42592-02	12

**01 thin bones, 02 thick bones.** – 01 lische fini, 02 lische grosse.



**SS**

**Cooking tong**

Pinza  
Kochzange  
Pinze  
Pinza

art.	l. cm.
42904-01	16



**SS**

**Cooking tong**

Pinza  
Kochzange  
Pinze  
Pinza

art.	l. cm.
42904-02	16



**SS**

**Cooking tong**

Pinza  
Kochzange  
Pinze  
Pinza

art.	l. cm.
42904-03	15



**SS**

**Sausage tongs**

Pinza per grill  
Grill-und Wurstzange  
Pince à saucisses  
Pinza para barbaça

art.	l. cm.
41697-00	38



**SS**

**Cooking tong**

Pinza  
Kochzange  
Pinze  
Pinza

art.	l. cm.
42902-31	30



**SS**

**Cooking tong**

Pinza  
Kochzange  
Pinze  
Pinza

art.	l. cm.
42902-30	30



**SS**

**Grill tweezer**

Molla per grill  
Grillzange  
Pince à grill  
Pinza para barbaça

art.	l. cm.
41698-22	22,5
41698-30	30,0
41698-40	40,0



**SS**

**Serving tong**

Pinza a servire  
Servierzange  
Pince à servir  
Pinza para servir

art.	l. cm.
42854C25	25
42854C30	30



**SS**

**Serving tong**

Pinza a servire  
Servierzange  
Pince à servir  
Pinza para servir

art.	l. cm.
42854B25	25
42854B30	30





SS

**Serving tong**  
Pinza a servire  
Servierzange  
Pince à servir  
Pinza para servir

art.	l. cm.
42854Y25	25
42854Y30	30



SS

**Serving tong**  
Pinza a servire  
Servierzange  
Pince à servir  
Pinza para servir

art.	l. cm.
42854K25	25
42854K30	30



SS

**Serving tong**  
Pinza a servire  
Servierzange  
Pince à servir  
Pinza para servir

art.	l. cm.
42854R25	25
42854R30	30



SS

**Serving tong**  
Pinza a servire  
Servierzange  
Pince à servir  
Pinza para servir

art.	l. cm.
42854G25	25
42854G30	30



**Cooking tong, silicone**  
Pinza, silicone  
Kochzange aus Silikon  
Pince en silicone  
Pinza de silicona

art.	l. cm.
42903-29	29



**Barbecue brush**  
Spazzola grill  
Grill-Bürste  
Brosse à grille  
Cepillo para barbacoa

art.	cm.	l. cm.
41773-00	5,5x11	27

Brass bristles. – Setole in ottone.



SS

**Whisk for basin**  
Frusta gigante  
Kesselbesen  
Fouet à bassine  
Batidor gigante

art.	l. cm.
41980-99	125



**Food-grade resin spatula**  
Spatola in resina alimentare  
Rührspaten für Speisenzubereitung  
Spatule en résine pour aliments  
Espátula de resina para alimentos

art.	cm.	l. cm.
44061-08	15,7x10,8	80
44061-09	23,5x10,8	90
44061-12	23,5x10,8	117
44061-14	23,5x10,8	137



SS

**Speed rack**  
Rastrelliera  
Flaschenregal  
Rack à bouteilles  
Rack de botellas

art.	cm.	h.	bot.
44060-50	56x10,5	15,5	6
44060-80	81x10,5	15,5	8



SS

**Hat pin for tickets**  
Spillone portascontrini  
Kassenscheine-Aufstecknadel  
Pique-addition  
Pinchanotas

art.	Ø cm.	h.
12504-20	9	20



W

**Hat pin for tickets**  
Spillone portascontrini  
Kassenscheine-Aufstecknadel  
Pique-addition  
Pinchanotas

art.	cm.	l. cm.
42504-09	9x5,5	10,5



SS

**Tickets-holder**  
Asta portascontrini  
Bons-/Zettelhalter  
Porte-fiches à billes  
Barra de notas

art.	l. cm.
42509-25	25
42509-50	50



SS

**Tab-grabber**  
Asta porta scontrini  
Bons-/Zettelhalter  
Porte-fiches  
Barra de notas

art.	l. cm.
42509-60	60
42509-99	100



SS

**Roll holder**  
Porta rotolo  
Rollenhalter  
Derouleur papier  
Portarollos

art.	l. cm.
42512-35	30



SS

**Wall film box**  
Supporto murale, porta pellicola  
Wand-Folien-Abreißgerät  
Dérouleur de film mural  
Soporte de pared para film

art.	l. cm.
42513-30	30
42513-45	45

**Roll max ø cm 13. – Rotolo ø max. cm 13.**



PP

**Additional plate stand**  
Anello distanziatore  
Gestell für Zusatzteller  
Support assiette supplémentaire  
Soporte distanciador

art.	Ø cm.	h.
47605-23	19-21	6



PP

**Plate cover**  
Copripiatto  
Tellerglocke  
Cloche  
Cubreplatos

art.	Ø cm.	h.
47603-25	25	6,5
47603-27	27	6,5
44998-31	31	6,5



PC

**Plate cover**  
Copripiatto  
Tellerglocke  
Cloche  
Cubreplatos

art.	Ø cm.	h.
44997-22	21	6,8
44997-24	23	6,8
44997-26	26	6,8
44997-28	28	6,8



SS

**Plate cover**  
Copripiatto  
Tellerglocke  
Cloche  
Cubreplatos

art.	Ø cm.	h.
41683-26	26,5	4,3



SS

**Funnel**  
Imbuto  
Trichter  
Entonnoir  
Embudo

art.	Ø cm.
42562-12	12
42562-14	14
42562-16	16
42562-18	18
42562-20	20
42562-25	25
42562-30	30





PP

**Funnel**  
Imbuto  
Trichter  
Entonnoir  
Embudo

art.	Ø cm.
47604-08	8
47604-10	10
47604-12	12
47604-15	15
47604-18	18
47604-20	20
47604-24	24
47604-30	30



PP

**Measuring jug**  
Caraffa graduata  
Messbecher  
Pichet gradué  
Jarra de medidas

art.	Ø cm.	h.	lt.
47608-02	19	12	2,2



PP

**Measuring jug**  
Caraffa graduata  
Messbecher  
Pichet gradué  
Jarra de medidas

art.	Ø cm.	h.	lt.
47606-02	8,5	10,0	0,25
47606-05	10,5	10,5	0,50
47606-10	12,5	14,5	1,00
47606-20	13,5	17,0	2,00
47606-30	15,5	21,0	3,00
47606-50	19,0	24,0	5,00



PP

**Measuring jug**  
Caraffa graduata  
Messbecher  
Pichet gradué  
Jarra de medidas

art.	Ø cm.	h.	lt.
47607-10	12,5	14,5	1
47607-20	13,5	17,0	2

**Lt. and ml. scale. Heat resistant up to 95°C.**  
Scala in lt e ml. Resistente fino a 95°C.



SS

**Graduated measure jug**  
Misurino graduato  
Messbecher, graduert  
Mesure graduée  
Jarra de medidas

art.	Ø cm.	h.	lt.
42581-01	7,5	5	0,1
42581-03	10,0	7	0,3
42581-05	11,5	11	0,5
42581-10	15,0	13	1,0
42581-15	15,5	15	1,5
42581-20	17	19	2,0



SS

**Measuring spoons, 4 pcs**  
Misurini set 4 pz  
Messlöffel Set 4-tlg.  
Cuillères à mesurer 4 pcs  
Cucharas medidoras 4 pz

art.	ml.
42615-04	1-2,5-5-15



SS

**Measuring cups, 4 pcs**  
Misurini set 4 pz  
Messlöffel Set 4-tlg.  
Cuillères à mesurer 4 pcs  
Cucharas medidoras 4 pz

art.	ml.
42616-04	60-80-125-250



SS

**Lever dispenser**  
Dosatore  
Hebeldosierspender  
Distributeur à manette  
Dispensador

art.	Ø cm.	h.
41528-21	21	22,5
41528-22	22	18,0

**Suitable for 5 kg bucket. – Per bidone da kg 5.**



AY

**Dispenser**  
Dosatore  
Dosierspender  
Doseur  
Dispensador

art.	ml.
47609-02	250
47609-03	350
47609-09	950
47609-13	1350



**AY**

**Dispenser**

Dosatore  
Dosierspender  
Doseur  
Dispensador

art.	ml.
47609-04	375
47609-07	750
47609-12	1250
47609-16	1650



**PE**

**Squeeze bottle**

Flacone dosatore  
Quetschflasche  
Flacon doseur  
Frasco dosificador

art.	ml.	col.
41526-R1	240	●
41526-R2	360	●
41526-R3	720	●



**PE**

**Squeeze bottle**

Flacone dosatore  
Quetschflasche  
Flacon doseur  
Frasco dosificador

art.	ml.	col.
41526-B1	240	○
41526-B2	360	○
41526-B3	720	○



**PE**

**Squeeze bottle**

Flacone dosatore  
Quetschflasche  
Flacon doseur  
Frasco dosificador

art.	ml.	col.
41526-G1	240	●
41526-G2	360	●
41526-G3	720	●



**PE**

**Squeeze bottle, 4 pcs**

Flacone dosatore, 4 pz  
Quetschflasche, 4 Stk  
Flacon doseur, 4 pcs  
Frasco dosificador, 4 pz

art.	Ø cm.	h.	ml.
41526-01	3	8,5	30



**PE**

**Squeeze bottle, 4 pcs**

Flacone dosatore, 4 pz  
Quetschflasche, 4 Stk  
Flacon doseur, 4 pcs  
Frasco dosificador, 4 pz

art.	Ø cm.	h.	ml.
41526-02	3,5	9,5	50



**PE**

**Squeeze bottle**

Flacone dosatore  
Quetschflasche  
Flacon doseur  
Frasco dosificador

art.	Ø cm.	h.	ml.
41526-05	5,0	18	200
41526-06	5,5	19	350



**PE**

**Triple nozzle squeeze bottle**

Flacone dosatore, triplo ugello  
Quetschflasche mit Dreifachdüse  
Flacon doseur à trois becs  
Frasco dosificador 3 boquillas

art.	ml.	col.
41520-08	235	○
41520-12	355	○
41520-16	470	○
41520-24	700	○



**SS**

**Decorating spoons 2 pcs**

Cucchiari decorazione 2 pz  
Dekoration-Löffel 2 Stk  
Cuillères pour décorer 2 pcs  
Cucharas para decoración 2 pz

art.	l. cm.
47831-02	19-23



SS

**Flour scoop**

Sessola tonda  
Mehlschaufel  
Pelle à farine  
Librador

art.	lt.
42609-10	0,10
42609-15	0,40
42609-20	1,00
42609-23	1,70
42609-25	2,80



PP

**Flour scoop**

Sessola  
Mehlschaufel  
Pelle à farine  
Librador

art.	cm.	lt.
17610-01	20x7	0,10
17610-02	27,5x9,5	0,25
17610-05	32,5x12	0,50
17610-10	39x15	1,00



PA+  
plus

**Flour scoop**

Sessola  
Mehlschaufel  
Pelle à farine  
Librador

art.	cm.	lt.
12940-02	27,5x9,5	0,25
12940-05	32,5x12	0,50
12940-10	39x15	1,00
12940-20	48x18	2,00
12940-25	50x19,5	2,50



SS

**Sieve with spare gauzes**

Setaccio rete intercambiabile  
Sieb mit auswechselbarem Siebeinsatz  
Tamis avec toiles de rechange  
Cernidor con red intercambiabile

art.	Ø cm.	Ø mm.
42590-02	30	*1,1
42590-03	30	*0,9

\*Mesh. – Rete.



SS

**Spare gauzes**

Rete intercambiabile  
Auswechselbarem Siebeinsatz  
Toiles de rechange  
Red intercambiabile

art.	Ø cm.	Ø mm.
42590R02	30	*1,1
42590R03	30	*0,9

\*Mesh. – Rete.



SS

**Bread sieve**

Setaccio pane  
Brot sieb  
Tamis à pain  
Cernidor para pan

art.	Ø cm.	h.
12604-22	22	8
12604-30	30	8
12604-34	34	8
12604-40	40	8

8 eye per inch. – 8 fori per 2,5 cm2.



SS

**Flour sieve**

Setaccio farina  
Mehlsieb  
Tamis à farine  
Cernidor para harina

art.	Ø cm.	h.
12605-22	22	8
12605-30	30	8
12605-34	34	8
12605-40	40	8

20 eye per inch. – 20 fori per 2,5 cm2.



SS

**Sieve**

Setaccio infarina pesce  
Sieb  
Tamis  
Cernidor

art.	Ø cm.	h.
12606-30	30	8
12606-34	34	8

4 eye per inch. – 4 fori per 2,5 cm2.



SS

**Sieve**

Setaccio rete pasticciare  
Sieb  
Tamis  
Cernidor

art.	Ø cm.	h.
12607-22	22	8
12607-30	30	8
12607-34	34	8

10 eye per inch. – 10 fori per 2,5 cm2.



SS

**Kitchenbowl, with handles**

Bacinella conica con maniglie  
Schüssel mit Griffen  
Bassine conique avec anses  
Caldero cónico con asas

art.	Ø cm.	h.	lt.
11955-32	32	16,0	8,8
11955-36	36	18,5	12,8
11955-40	40	20,0	17,0
11955-45	45	22,5	24,5
11955-50	50	24,0	32,5



SS

**Conical colander**

Colapasta tronco conico  
Gemüsesieher  
Passoire à légumes  
Colador cónico

art.	Ø cm.	h.	lt.
11930-24	24	12,0	3,5
11930-28	28	14,0	5,5
11930-32	32	16,0	8,8
11930-36	36	18,5	12,8
11930-40	40	20,0	17,0
11930-45	45	22,5	24,5
11930-50	50	24,0	32,5



SS

**Conical colander**

Colapasta tronco conico  
Gemüsesieher  
Passoire à légumes  
Colador cónico

art.	Ø cm.	h.	lt.
11927-24	24	12,0	3,5
11927-28	28	14,0	5,5
11927-32	32	16,0	8,8
11927-36	36	18,5	12,8
11927-40	40	20,0	17,0
11927-45	45	22,5	24,5
11927-50	50	24,0	32,5



SS

**Hemispherical mixing bowl**

Bacinella semisferica  
Schüssel  
Bassine demi-ronde  
Caldero semiesférico

art.	Ø cm.	lt.
11957-20	20	2,0
11957-25	25	3,7
11957-30	30	7,2
11957-35	35	10,5
11957-40	40	15,6



NSF

SS

**Kitchenbowl low**

Bacinella conica bassa  
Schüssel, flach  
Bassine  
Caldero cónico

art.	Ø cm.	h.	lt.
12582-13	13,2	6,0	0,5
12582-17	16,5	7,5	1,0
12582-22	22,0	7,5	2,0
12582-24	24,0	9,5	3,0
12582-32	30,5	11,5	6,0
12582-34	32,5	14,0	8,0
12582-38	38,0	13,5	11,0
12582-40	40,0	15,0	14,0



NSF

SS

**Kitchenbowl high**

Bacinella conica alta  
Tiefe Schüssel  
Bassine haute  
Caldero cónico alto

art.	Ø cm.	h.	lt.
12580-11	11,7	7,0	0,5
12580-17	15,5	9,0	1,0
12580-21	19,0	11,5	2,0
12580-24	22,0	12,0	3,0
12580-29	27,0	13,5	5,0
12580-30	29,0	15,0	6,0
12580-31	30,5	17,0	8,0
12580-36	35,5	18,5	11,0
12580-40	40,0	20,0	17,0
12580-45	45,0	22,0	25,0
12580-50	50,0	24,0	33,0



PA+  
plus

**Conical colander**

Colatutto tronco conico  
Gemüsesieher  
Passoire à légumes  
Colador cónico

art.	Ø cm.	h.	lt.
12950-32	32	16	8
12950-40	40	20	12



**Conical colander, aluminium**

Colapasta tronco conico, alluminio  
Gemüsesieher, Aluminium  
Passoire à légumes, alu  
Colador cónico, aluminio

art.	Ø cm.	h.	lt.
16927-32	32	16,0	8,8
16927-36	36	18,5	12,8
16927-40	40	20,0	17,0
16927-45	45	22,5	24,5
16927-50	50	24,0	32,5



SS

**Colander**

Colapasta con cerchio  
Gemüsesieher  
Passoire à légumes  
Colador con base

art.	Ø cm.	h.	lt.
11928-32	32	18,0	9,5
11928-36	36	19,0	12,0
11928-40	40	21,0	14,5



SS

**Strainer**

Colapasta semisferico  
Stielsieb  
Passoire hémispherique  
Colador semiesférico

art.	Ø cm.	h.	lt.
11926-22	22	12	2,7
11926-26	26	14	4,0



SS

**Strainer**

Colapasta  
Stielsieb  
Passoire  
Colador

art.	Ø cm.	h.	lt.
11924-18	18	11	2,8
11924-20	20	12	3,6
11924-22	22	13	5,0
11924-24	24	14	6,5
11924-28	28	15	9,3



**Strainer, aluminium**

Colapasta, alluminio  
Stielsieb, Aluminium  
Passoire, alu  
Colador, aluminio

art.	Ø cm.	h.	lt.
16924-20	20	11	3,2
16924-24	24	13	6,0
16924-28	28	15	9,3



PP

**Strainer**

Colapasta  
Stielsieb  
Passoire  
Colador

art.	Ø cm.
47610-22	22
47610-26	26
47610-30	30



PP

**Strainer**

Colapasta  
Stielsieb  
Passoire  
Colador

art.	Ø cm.
47610-18	18



PE

**Graduated bucket**

Secchio graduato  
Eimer mit Skala  
Seau gradué  
Cubo con medidas

art.	Ø cm.	h.	lt.
49889-09	27	26,2	9
49889-12	29	29,0	12
49889-15	31	30,8	15

With spout. – Con becco.



SS

**Graduated bucket**

Secchio graduato  
Eimer mit Skala  
Seau gradué  
Cubo con medidas

art.	Ø cm.	h.	lt.
41960-08	28,5	20,5	8
41960-10	30,0	25,0	10
41960-12	31,0	27,0	12
41960-15	32,5	31,0	15



SS

**Graduated bucket with bottom ring**

Secchio graduato con base  
Eimer mit Fuss u. Skala  
Seau gradué avec base  
Cubo con medidas y base

art.	Ø cm.	h.	lt.
41961-10	30,0	26,5	10
41961-12	31,0	28,5	12
41961-15	32,5	32,5	15



SS

**Lid for bucket**

Coperchio per secchio  
Deckel für Eimer  
Couvercle pour seau  
Tapa para cubo

art.	Ø cm.
41962-10	30,0
41962-12	31,0
41962-15	32,5



**PE**

**Mixing bowl**

Bacinella tonda  
Schüssel  
Bassine ronde  
Caldero semiesférico

art.	Ø cm.	h.	lt.
47600-16	16	7,0	0,9
47600-20	20	8,5	1,6
47600-24	24	10,0	2,8
47600-28	28	11,0	4,5
47600-32	32	12,5	6,5
47600-36	36	14,0	10,0
47600-40	40	15,5	13,5



**PP**

**Mixing bowl**

Bacinella tonda  
Schüssel  
Bassine ronde  
Caldero semiesférico

art.	Ø cm.	h.	lt.
47611-01	19,0	7,9	1,0
47611-03	24,0	11,5	2,5
47611-05	28,0	13,5	4,5
47611-06	32,5	14,7	6,0
47611-09	36,0	16,5	9,0
47611-13	40,0	18,5	13,0



**PP**

**Lid**

Coperchio  
Deckel  
Couverture  
Tapa

art.	Ø cm.
47611-11	19,0
47611-14	24,0
47611-15	28,0
47611-16	32,5
47611-19	36,0
47611-23	40,0



**SS**

**Mixing bowl**

Bastardella semisferica  
Schneeslagkessel  
Bassine hémispherique  
Caldero con asas

art.	Ø cm.	h.	lt.
11952-22	22	12,0	2,7
11952-26	26	14,0	4,0
11952-32	32	18,0	9,5
11952-36	36	20,5	14,0
11952-40	40	21,5	18,0



**SS**

**Mixing bowl without handles**

Bastardella senza maniglie  
Schneeslagkessel ohne Griffe  
Bassine hémispherique sans anses  
Caldero sin asas

art.	Ø cm.	h.	lt.
11951-22	22	12,0	2,7
11951-26	26	14,0	4,0
11951-32	32	18,0	9,5
11951-36	36	20,5	14,0
11951-40	40	21,5	18,0



**SS**

**Foot for mixing bowl**

Base per bastardella  
Fuss für Schneeslagkessel  
Base pour bassine hémispherique  
Base para caldero

art.	Ø cm.	for/per Ø
11953-16	16	22-26
11953-22	22	32-36-40



**SS**

**Kettle for mixing machines**

Bacinella per planetaria  
Schlagmaschinenkessel  
Bol pour mélangeurs  
Caldero para batidera

art.	Ø cm.	h.	lt.
11954-26	26	20,0	10,0
11954-30	30	25,0	16,0
11954-32	32	30,0	20,0
11954-36	36	28,5	25,0
11954-37	36	35,0	32,0
11954-40	40	35,5	40,0



**SS**

**Kitchen bowl with handle**

Tazzone con manico  
Schlagschüssel mit Rohrstiel  
Bol avec manche  
Cazo bombeado

art.	Ø cm.	h.	lt.
41916-10	15	8,0	1,0
41916-15	17	9,0	1,2
41916-20	19	10,0	2,0



**Induction adapter**

Adattatore induzione  
Induktion Adapterplatte  
Disque relais pour induction  
Adaptador para inducción

art.	Ø cm.
41922-16	16
41922-22	20





**Manual salad spinner**

Centrifuga manuale per verdura  
Salatschleuder  
Essoreuse manuelle à salade  
Centrifugadora de ensalada

art.	Ø cm.	h.	lt.
49888-10	33	43	12
49888-20	43	52	25



SS

**Soup strainer**

Colino a rete  
Suppensieb  
Passe-bouillon  
Colador a red

art.	Ø cm.	l. cm.
12622-07	7	12
12622-10	10	12
12622-12	12	17
12622-14	14	17
12622-16	16	17
12622-18	18	17
12622-20	20	17
12622-23	23	27
12622-26	26	27



SS

**Strainer, double mesh**

Colapasta doppia rete  
Passiersieb, doppelnetz  
Passoire, maille double  
Colador doble red

art.	Ø cm.	l. cm.
12633-16	16	17
12633-18	18	17
12633-20	20	17
12633-23	23	27
12633-26	26	27



SS

**Strainer**

Colatutto  
Sieb  
Passoire  
Colador multiuso

art.	cm.	l. cm.
12630-22	22x18	19



SS

**Strainer**

Colino  
Sieb  
Passoire  
Colador

art.	Ø cm.
41570-10	8



SS

**Strainer, reinforced**

Colapasta rinforzato  
Grossküchensieb mit Verstärkung  
Passoire renforcé  
Colador reforzado

art.	Ø cm.	l. cm.
12635-23	23	27
12635-26	26	27
12635-30	30	44
12635-35	35	44



SS

**Vegetable sieve**

Passaverdura  
Passiergerät  
Mini hache-tout  
Pasa verdura

art.	Ø cm.
12638-20	20



SS

**Strainer**

Colatutto gigante  
Grossküchensieb  
Passoire géant  
Colador multiuso gigante

art.	Ø cm.	l. cm.
12636-32	32	60



SS

**Chinese colander**

Cornetto cinese  
Spitzsieb  
Passoire chinois  
Colador chino

art.	Ø cm.
41925-14	14
41925-16	16
41925-18	18
41925-20	20
41925-22	22
41925-24	24
41925-26	26



SS

**Chinese colander stand**  
Supporto per cornetto cinese  
Träger für Spitzsieb  
Support chinois  
Soporte para colador chino

art.	Ø cm.	h.
41933-18	18	28



SS

**Colander with wire gauze**  
Cornetto cinese a rete  
Gazensieb  
Chinois à gaze  
Colador chino a red

art.	Ø cm.
11929-20	20
11929-24	24



SS

**Chinese colander with wire protection**  
Cornetto con protezione  
Spitzsieb mit Verstärkung  
Chinois à gaze avec renfort  
Colador chino con protección

art.	Ø cm.
11932-20	20
11932-24	24



SS

**Chinese soup strainer**  
Collino conico a rete  
Suppen-Spitzsieb  
Passe-bouillon chinois  
Colador cónico a red

art.	Ø cm.
41931-08	8
41931-14	14
41931-16	16
41931-18	18



**Bouillon cloth**  
Panno passabrodo  
Bouillonstoffsieb  
Etamine passe-bouillon  
Paño para pasar caldo

art.	cm.	U. Pack
41932-05	87x70	5

**Twisted cotton cloth with seam.**  
Tela di cotone ritorto, orlata.



ABS

**Rice scoop**  
Porzionatore  
Reis-Portionierer  
Portionneur  
Racionador

art.	h.	gr.
42653-04	4,5	120-130



**PA+**  
plus

**Portion ring**  
Anello per impiattare  
Portionierspeisering  
Cercle portionneur  
Anillo porcionador

art.	Ø cm.	h.
12943-03	3	3,5
12943-05	5	3,5
12943-07	7	3,5
12943-08	8	3,5
12943-10	10	3,5
12943-12	12	3,5



**PA+**  
plus

**Portion ring**  
Anello per impiattare  
Portionierspeisering  
Cercle portionneur  
Anillo porcionador

art.	Ø cm.	h.
12944-03	3	3,5
12944-05	5	3,5
12944-07	7	3,5
12944-08	8	3,5
12944-10	10	3,5
12944-12	12	3,5



PP

**Bag clip**  
Clip chiudi sacco  
Verschluss-Clip  
Clip ferme sachet  
Pinza cierra bolsas

art.	l. cm.	pcs/pz
42908-24	24	1

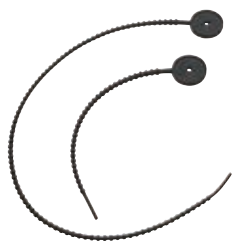

**Foodloops, silicone, 6 pcs**

Laccetti da cucina, silicone, 6 pz  
 Silikonbänder, 6 Stk  
 Lacets de cuisson, silicone, 6 pcs  
 Lazos de silicona de cocina, 6 pz

art.	l. cm.
41595B44	22
41595B45	53



**Presse canard, bronzo**

Presse canard, bronzo  
 Presse canard, Bronze  
 Presse à canard, bronze  
 Prensador para canard, bronze

art.	h.	Kg.
49845-01	52	16

Tinned. – Stagnato.



**Octopus-press**

Pressapolipo  
 Krake-Press  
 Presse à poulpe  
 Prensador para pulpo

art.	Ø cm.	h.
49760-00	10,5	20,5



**Mini-guitar**

Mini-chitarra  
 Mini-Guitare  
 Mini-guitare  
 Mini guitarra

art.	cm.	Kg.
49839-00	45x23x15	4,9

For products with tender and homogeneous consistency. Cut width 14,5 cm, thickness 5 mm.  
 Per prodotti teneri ma di consistenza omogenea.  
 Larghezza taglio 14,5 cm, spessore 5 mm.



**Tomato cutter**

Affetta pomodori  
 Tomatenschneider  
 Coupe-tomates  
 Cortador tomates

art.	cm.	Kg.
49837-05	30x14x18	2

Slice thickness 5,5 mm. – Spessore taglio 5,5 mm.

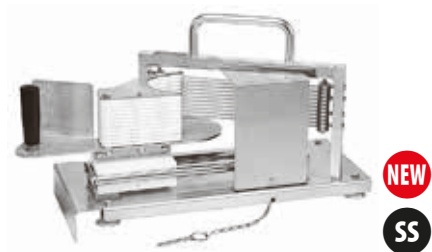

**Mozzarella/tomato cutter**

Affetta mozzarella/pomodori  
 Mozzarella-/Tomatenschneider  
 Coupe-mozzarella/tomates  
 Cortador mozzarella/tomates

art.	cm.	Kg.
49820-05	48x20x32	7,1

Also suitable for cutting lemons, oranges or kiwis, etc. Slice thickness 5,5 mm.  
 Adatto anche per tagliare limoni, arance o kiwi, ecc. Spessore fetta 5,5 mm.





**SS**

**Fruit cutter**

Trancia spicchi  
Früchteschneider  
Coupe-fruits  
Cortador tomates

art. cm. Kg.  
49838-08 38x26x58 3,3

**8 wedges, for vegetables and fruits without stone. – 8 spicchi, per ortaggi e frutta senza nocciolo.**



**Apple corer/wedger set of blades**

Set lame levatorsolo e trancia spicchi  
Apfelentkerner-/Schneidmesser  
Lames évideur/coupe-pommes  
Saca corazón y cortador para manzanas

art.  
49838-98



**SS**

**Cube cutter**

Taglia cubi  
Würfel-Schneidgerät  
Coupe-cubes  
Cortador en dados

art. cm. Kg.  
49821-08 35,5x26x66 4

**Dice thickness 8 mm. – Spessore taglio 8 mm.**



**Epoxy peeler on stand**

Pela carote/verdure supporto epossidico  
Gemüseschäler, Epoxidfuß  
Éplucheur sur pied epoxy  
Pelador sobre pie epoxy

art. cm. Kg.  
49819-00 21,5x14x51 1,8

**Equipped with ø 4,5 cm. – Dotazione ø 4,5 cm.**

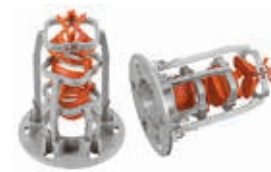

**Additional peeling heads**

Accessori opzionali per pela verdure  
Schälkopf-Zusatzteile  
Têtes supplémentaires pour eplucheur  
Cabezas suplementarios para pelador

art. Ø cm.  
49819-01 4,5  
49819-02 6,0



**SS**

**Vegetable cutter**

Taglia verdure  
Gemüseschneider  
Machine à tourner les légumes  
Cortador de verduras

art. cm. Kg.  
49842-00 21x17,5x19 3,2

**To make chateau potatoes, cocottes and fondants lenght from 4 to 8 cm. 3 position adjustable blade. – Per patate chateau, cocotte e fondenti di lunghezza da 4 a 8 cm. Lama con 3 regolazioni di taglio.**



**SS**

**Pineapple-peeler/corer**

Pela/svuota ananas  
Ananasschälmaschine  
Epluche-ananas  
Pelador de piña

art. cm. Kg.  
49818-00 45x39x72 18

**Blade and pusher ø 89 mm.  
Lama e pressatore ø 89 mm.**



**Additional pushers and blades**

Pressatori e lame opzionali  
Zusätzliche Presse und Messer  
Poussoirs et couteaux supplémentaires  
Empujador y cuchilla suplementarios

art. Ø cm.  
49818-AC 7,4  
49818-AD 7,4  
49818-AE 10,2  
49818-AF 10,2

**AC, AE: blade - AD, AF: pusher.  
AC, AE: lama - AD, AF: pressatore.**



SS

**Pineapple slicer**  
 Taglia ananas  
 Ananasteiler  
 Coupe-ananas en rondelle  
 Cortador de piña en rondajas

art. Ø cm. l. cm.  
 48218-00 2,5 24



SS

**Pineapple coring tool**  
 Svuota ananas  
 Ananasausstecher  
 Vide ananas  
 Saca corazón de piña

art. Ø cm. l. cm.  
 48280-10 2,5 24



**Electric peeler**  
 Pelatrice elettrica  
 Elektr. Schälmachine  
 Eplucheur électrique  
 Pelador eléctrico

art. cm. Kg.  
 49750-00 25x16x21,5 2



**Professional apple peeler**  
 Pela mele professionale  
 Profi-Apfelschäler  
 Pèle-pommes, professionnel  
 Pelador de manzanas, profesional

art. cm. Kg.  
 49834-00 32x14x10 1,9



**Orange peeler with screw**  
 Pela arance con morsetto  
 Orangenschäler, Tischklemme  
 Pèle-orange, socle serre-joint  
 Pelador de naranjas, fijación brida

art. cm.  
 49817-00 30x10x15



**Apple peeler with screw**  
 Pela mele con morsetto  
 Apfelschäler, Tischklemme  
 Pèle-pommes, socle serre-joint  
 Pelador de manzanas, fijación brida

art. cm.  
 49835-00 30x10x17



**Apple peeler, vacuum-power base**  
 Pela mele con ventosa  
 Apfelschäler, Vakuum-Fuss  
 Pèle-pommes, socle vacuum  
 Pelador de manzanas, fijación ventosa

art. cm.  
 49836-00 30x10x13



SS

**Potato twist cutter**  
 Tagliaverdure ghirlanda  
 Kartoffeln-Spiralschneider  
 Machine à brochette  
 Coratador de verduras

art. cm. Kg.  
 49843-00 33x13x45 3,4

Slice thickness 2,5 mm. – Spessore taglio 2,5 mm.



SS

**Apple corer/wedger**  
 Trancia spicchi per mela  
 Apfelenkerner-/Schneider  
 Lames évideur/coupe-pommes  
 Cortador y descorazonador manzanas

art. Ø cm.  
 48289-10 10



SS

**Egg wedger**  
 Taglia uova  
 Eierteiler  
 Tranche-oeufs  
 Cortahuevos

art. Ø cm. l. cm.  
 42597-00 6,5 21



SS

**Egg knocker**

Apriuovo  
Eierköpfer  
Toque oeuf  
Abridor de huevos

art. Ø cm. l. cm.  
42595-01 3,2 11



**Egg slicer, aluminum**

Taglia uova, alluminio  
Eierteiler, Aluminium  
Tranche-oeufs rondelle, aluminium  
Cortahuevos guitarra, aluminio

art. cm.  
42588-01 13,5x8x4,5



**Egg slicer duo**

Taglia uova doppio  
Eierteiler 2 in 1  
Tranche-oeufs 2 emplacements  
Cortahuevos doble

art. cm.  
42588-00 21x8x4,5



**Egg container**

Contentitore per uova  
Eier-Behälter  
Porte-oeufs  
Contenedor para huevos

art. cm.  
47093-24 30x21,5x6,5



AY

**Egg container**

Contentitore per uova  
Eier-Behälter  
Porte-oeufs  
Contenedor para huevos

art. cm.  
44947-07 15x20x5



SS

**Egg rings 2 pcs**

Anelli per uova 2 pz  
Eierringe, 2 Stk  
Ronds à oeufs, 2 pcs  
Anillos para huevos, 2 pz

art. Ø cm. h.  
42596-02 8 1,5



**Egg ring, non stick**

Anello per uova, antiaderente  
Eierring, beschichtet  
Rond à oeufs, anti-adhésif  
Anillo para huevos, antiadherente

art. Ø cm. h.  
42650-10 10 1,5



**Egg ring, non stick**

Anello per uova, antiaderente  
Eierring, beschichtet  
Rond à oeufs, anti-adhésif  
Anillo para huevos, antiadherente

art. Ø cm. h.  
42650-11 11 1,5



NEW

**Artichoke corer**

Svuota carciofi  
Artischocken Entkerner  
Etrogneur à artichauts  
Saca corazon para alcachofas

art. Ø cm. h.  
48288-02 8 8



NEW

**Brussel sprout cutter**

Taglia cavolini di Bruxelles  
Rosenkohl-Schneider  
Coupe-choux de Bruxelles  
Cortador de coles de Bruselas

art. cm.  
48288-03 8x8x10

**Top-rack dishwasher-safe. ABS body and scoop, PP cover, stainless steel blade.**

Lavabile in lavastoviglie nel cestello superiore. Corpo e paletta in ABS, coperchio in PP, lama inox.

**Dishwasher safe. SAN transparent body, ABS frame, PP base, stainless steel blade.**

Lavabile in lavastoviglie. Corpo trasparente SAN, telaio in ABS, base in PP, lama inox.



SS

**Mushroom cutter**

Taglia funghi  
Pilze-Teiler  
Tranche-champignons  
Cortador de hongas

art.	Ø cm.	l. cm.
42598-00	7,6	20,7



SS

**Avocado peeler and slicer**

Pela/taglia avocado  
Avocadoschäler-/Teiler  
Pèle et tranche avocat  
Pelador y cortador de aguacete

art.	l. cm.
48286-62	18,5



SS

**Large vegetable slicer**

Pelaverdure  
Gemüeschäler  
Eplucheur à légumes  
Pelador de verduras

art.	cm.
48286-64	22x10



**Potato peeler**

Pelapatate  
Sparschäler  
Eplucheur  
Pelador de patatas

art.	cm.
42589-00	5x4



SS

**Potato ricer with 3 discs**

Schiacciapatate, 3 griglie  
Kartoffelpresse, 3 Roste  
Presse-purée, 3 grilles  
Pasapurés, 3 discos

art.	Ø cm.	cm.
42566-03	8,5	30x10x11

Discs/Dischi: ø 2,4 - 4,4 - 6,5 mm.



SS

**French fry cutter**

Taglia patate  
Kartoffelschneidergerät  
Coupe-frites  
Cortador de patatas fritas

art.	cm.	Kg.
49832-10	24x44x34	11

Cutting knife/Quadro di taglio: 10 mm.



NEW

SS

**French fry cutter**

Taglia patate  
Kartoffelschneidergerät  
Coupe-frites  
Cortador de patatas fritas

art.	cm.
49831-10	28x11x16,5

Functional and solid. With suction base. Space-saving size. Accurate cutting 10 mm. Easy to clean – Funzionale e solido. Base con ventose. Salvaspazio. Taglio preciso, 10 mm. Facile da pulire.



SS

**French fry cutter**

Taglia patate  
Kartoffelschneidergerät  
Coupe-frites  
Cortador de patatas fritas

art.	cm.	Kg.
49832-02	26x9x12,5	1,2

Cutting knives/Quadri di taglio: 9x9 - 12x12 mm.



**Herb scissors, 5 blades**

Forbice per erbe, 5 lame  
Kräuterschere, 5 Klingen  
Ciseaux à herbes, 5 lames  
Tijeras hierbas, 5 cuchillas

art.	l. cm.
18277-00	10



**Cheese rotary grater**

Grattugia formaggio rotatoria  
Drehe-Käse-Raffel  
Frisette à fromage  
Ralladora giratoria para queso

art.	Ø cm.	h.
48281-22	22	16

**Wood base. – Base legno.**



**Rotary grater cover**

Cloche per grattugia rotatoria  
Käse-Raffel-Haube  
Cloche à frisette  
Tapa para ralladora

art.	Ø cm.	h.
48281-23	15,5	11



**Tortillas wedger**

Taglia tortillas  
Tortillasteiler  
Coupe-tortillas  
Corta tortillas

art.	Ø cm.
42599-06	25
42599-08	25

**Wedges/Spicchi: 6 - 8.**

**SS**



**Grater, automatic**

Grattugia automatica  
Reibe, automatisch  
Râpe automatique  
Rallador automático

art.	cm.
48295-10	20x5,4

**Hermetic container, removable, with lid, 2 blades.  
Ideal for cheese, nuts, chocolate. etc.**  
Recipiente ermetico, removibile, con cop., 2 lame.  
Ideale per formaggio, noci, cioccolato, ecc.



**SS**

**Cheese wire cutter**

Lira per formaggi  
Käse Drahtschneider  
Lyre à fromage  
Lira para quesos

art.	cm.
48282-21	20,5x26,7



**Garlic press, chromed**

Spremiaglio, cromato  
Knoblauchpresse, verchromt  
Presse-ail, chromé  
Prensador de ajo, cromado

art.	Ø cm.	l. cm.
42565-00	3,5x2,5	14,5



**Olive seed remover, chromed**

Snocciolatore, cromato  
Olivenentsteiner, verchromt  
Dénoyauteur, chromé  
Quita pepa/hueso, cromado

art.	l. cm.
42563-00	17





**Cherry core stripper**  
 Snocciolatore  
 Kirschenentsteiner  
 Dénoyauteur de cerises  
 Quita pepa/hueso

art.	Ø cm.	h.
42563-44	10	34



SS

**Mandoline**  
 Mandolino  
 Gemüsehobel Mandoline  
 Mandoline  
 Mandolina

art.	cm.	Kg.
49829-11	39x12,5x5,5	1,7

Equipped with 7 interchangeable blades.  
 Dotato di 7 lame intercambiabili.



SS

**Slicer Mandoline, Grand Gourmet**  
 Mandolino Grand Gourmet  
 Gemüsehobel Grand Gourmet  
 Mandoline Grand Gourmet  
 Mandolina Grand Gourmet

art.	cm.	Kg.
49830-60	40x12x28	1,6

38 blades, 10 mm. – 38 lame, 10 mm.



NEW

SS

**Mandoline**  
 Mandolino  
 Gemüsehobel Mandoline  
 Mandoline  
 Mandolina

art.	cm.	Kg.
49755-10	38x11x3,5	1

Non-slip base, ergonomic handle. Adjustable and precise cutting thickness.  
 Base antiscivolo, impugnatura ergonomica. Spessore di taglio regolabile e preciso.



SS

**Mandoline**  
 Mandolino  
 Gemüsehobel Mandoline  
 Mandoline  
 Mandolina

art.	cm.	Kg.
49752-00	33,5x11x2,3	0,6

3 interchangeable blades of 2-3-6 mm.  
 3 lame intercambiabili da 2-3-6 mm.



ABS

**Japanese Mandoline slicer**  
 Mandolino giapponese  
 Japanese Gemüsehobel  
 Mandoline japonaise  
 Mandolina japonés

art.	cm.	Kg.
49753-06	11x31,5x3	0,3
49753-09	15x35x3,3	0,5

1 plain blade and 3 blades of 1-2-3 mm.  
 1 lama liscia e 3 lame da 1-2-3 mm.



SS

**Cutter/corer**  
 Intaglia verdure  
 Ausstechforme  
 Découpoir  
 Sacabocados

art.	cm.
48286-70	3,7x8,5x9

Cutting ø 3,4 cm. – Taglio ø 3,4 cm.



SS

**Cutter turn'up**  
 Tagliaverdura turn'up  
 Ausstechforme Turn'Up  
 Découpoir pour fonds à garnir  
 Descorazonador-vaciador turn'up

art.	Ø cm.	h.
48285-04	4	14,5
48285-05	5	14,5



NEW  
ABS  
SS

**Spiral vegetable slicer 7-blades 8-cuts**

Taglia verdure 7-lame 8-tagli  
Gemüseschneider 7-Messer 8-Schnitte  
Coupe légumes 7-lames 8-coupes  
Cortador de verduras 7-cuchillas 8-cortes

art. cm.  
49827-77 14,3x23,8x14,3

**The 8-cut collapsible spiralizer can be used with a wide range of fruits and vegetables. Blades included: 4 mm straight blade, 10 mm chipper blade, 1,5 mm wavy blade, 2,5 mm straight blade, 2 mm Angel hair blade, 3 mm shredder blade, 6 mm chipper blade. Bpa-free. Patented. All parts are top-rack dishwasher-safe.** – Il taglia verdure a 8 tagli può essere utilizzato con una vasta gamma di frutta e verdura. Lame incluse: 2 lame lisce mm 2,5 e 4, lama ondulata da 1,5 mm, lama capelli d'angelo da 2 mm, 3 lame taglio spaghetti mm. 3, 6 e 10. Senza BPA. Brevettato. Tutte le parti sono lavabili in lavastoviglie nel cestello superiore.



ABS  
SS

**Spiral vegetable slicer 3-blade**

Taglia verdure 3-lame  
Gemüseschneider 3-Messer  
Coupe légumes 3 lames  
Cortador de verduras 3 cuchillas

art. cm.  
49827-99 30x14x22

**3 interchangeable s/s blades (3 - 6 mm. and 1 straight blade for ribbon cuts). Ideal for julienne cuts, chips, spiral shapes, rings and plain slices of vegetables and fruits.** – 3 lame inox intercambiabili (3 - 6 mm. e 1 lama dritta per taglio a nastro). Ideale per julienne, chips, riccioli, anelli e fette sottili di verdura e frutta.



**Spiral vegetable slicer, plastic**

Taglia verdure, plastica  
Gemüseschneider, Kunststoff  
Coupe légumes, plastique  
Cortador de verduras, plástico

art. Ø cm. h.  
49825-05 8 15



SS

**Strip slicer**

Taglia verdure  
Gemüseschneider  
Coupe-lanières  
Cortador de verduras japonés

art. cm. Kg.  
49823-00 20x20x25 1,9

**Width of cut 15 cm. Max vegetables length 11 cm. and ø 17 cm.** – Larghezza taglio 15 cm. Lunghezza max verdura 11 cm. e ø 17 cm.



ABS

**Strip slicer**

Taglia verdure  
Gemüseschneider  
Coupe lanière  
Cortador de verduras

art. cm.  
49823-89 28x25x16,5

**Width of cut 13 cm. Thickness 0,5 mm.** – Larghezza taglio 13 cm. Spessore 0,5 mm.



ABS

**Strip & spaghetti slicer**

Taglia verdure  
Gemüseschneider  
Coupe lanière et spaghetti  
Cortador de verduras japonés

art. cm.  
49823-99 28x25x16,5

**Width of cut 13 cm. 2 blades 130x0,5 - 1x1,2 mm.**  
Larghezza taglio 13 cm. 2 lame 130x0,5 - 1x1,2 mm.



ABS

SS

**Vegetable cutter LE ROUET GOURMET**

Taglia verdure  
Gemüseschneider  
Coupe légumes  
Cortador de verduras

art. cm. Kg.  
49827-03 13,5x36x24,3 2,4

**Cutting blocks 1-2-4 mm. Cutting thickness blade guirlandes 1>4 mm. - Pettini taglio 1-2-4 mm. Spessore taglio lama guirlandes 1>4 mm.**



SS

**Thai knife**

Stiletto thailandese  
Thai-Messer  
Stylet thai  
Cuchillo thai

art. l. cm.  
48286-08 16



SS

**Decoration tools 18 pcs**

Attrezzi decoro, 18 pz  
Dekoriersatz, 18-Tlg.  
Outils de décor 18 pcs  
Herramientas decoración 18 pz

art.  
48286-03



SS

**Decoration tools 22 pcs**

Attrezzi decoro, 22 pezzi  
Dekoriersatz, 22-Tlg.  
Outils de décor 22 pcs  
Herramientas decoración 22 pz

art. cm.  
48286-13 38,5x29



**Ice knife**

Coltello ghiaccio  
Eis-Messer  
Couteau à glace  
Cuchillo para hielo

art. l. cm. Kg.  
47885-01 25 0,12



**Chisel V shape**

Scalpello ghiaccio a V  
Eismeissel  
Ciseau à glace  
Cinsel a V para hielo

art. l. cm. Kg.  
47885-02 31,5 0,28



**Chisel flat medium**

Scalpello ghiaccio 3 lati smussati  
Eismeissel  
Ciseau à glace  
Cinsel para hielo

art. l. cm. Kg.  
47885-03 50 0,45



**Chisel flat big**

Scalpello ghiaccio 1 lato smussato  
Eismeissel  
Ciseau à glace  
Cinsel para hielo

art. l. cm. Kg.  
47885-04 74,5 0,78



**Ice chisel set 4 pcs**

Scalpelli ghiaccio 4 pz  
Eismeissel 4 Stk  
Ciseaux à glace 4 pcs  
Cinseles para hielo 4 piezas

art.  
47885-05



**Butter churn**

Mantecatore per burro  
Butterfaß  
Baratte à beurre  
Mantequera

art. cm. lt.  
48294-01 11,5x11,5x40 1,6



**Butter mold**

Stampo per burro  
Butterform  
Moule à beurre  
Molde para mantequilla

art. cm. gr.  
48294-02 12,2x6,6x4,3 80



**Butter mold**

Stampo per burro  
Butterform  
Moule à beurre  
Molde para mantequilla

art. cm. gr.  
48294-03 15,8x9x5 125



**Butter mold**

Stampo per burro  
Butterform  
Moule à beurre  
Molde para mantequilla

art. cm. gr.  
48294-04 21x9,4x5,8 250



**Grater, non-slip handle**

Grattugia, manico antiscivolo  
Reibe, Rutschfestes Griff  
Râpe queue antidérapant  
Rallador mango antiderrapante

art. cm. l. cm.  
42560-01 4x22 38,5



**Grater, non-slip handle**

Grattugia, manico antiscivolo  
Reibe, Rutschfestes Griff  
Râpe queue antidérapant  
Rallador mango antiderrapante

art. cm. l. cm.  
42560-02 4x22 38,5



**Grater, non-slip handle**

Grattugia, manico antiscivolo  
Reibe, Rutschfestes Griff  
Râpe queue antidérapant  
Rallador mango antiderrapante

art. cm. l. cm.  
42560-03 4x22 38,5



**Grater, non-slip handle**  
 Grattugia, manico antiscivolo  
 Reibe, Rutschfestes Griff  
 Râpe queue antidérapant  
 Rallador mango antiderrapante

art. cm. l. cm.

42560-04 7,7x13,3 30



**Grater, non-slip handle**  
 Grattugia, manico antiscivolo  
 Reibe, Rutschfestes Griff  
 Râpe queue antidérapant  
 Rallador mango antiderrapante

art. cm. l. cm.

42560-05 7,7x13,3 30



**Grater, non-slip handle**  
 Grattugia, manico antiscivolo  
 Reibe, Rutschfestes Griff  
 Râpe queue antidérapant  
 Rallador mango antiderrapante

art. cm. l. cm.

42560-06 7,7x13,3 30



**Grater, non-slip handle**  
 Grattugia, manico antiscivolo  
 Reibe, Rutschfestes Griff  
 Râpe queue antidérapant  
 Rallador mango antiderrapante

art. cm. l. cm.

42560-07 7,7x13,3 30



**Grater, non-slip handle**  
 Grattugia, manico antiscivolo  
 Reibe, Rutschfestes Griff  
 Râpe queue antidérapant  
 Rallador mango antiderrapante

art. cm. l. cm.

42560-08 7,7x13,3 30



**Grater, non-slip handle**  
 Grattugia, manico antiscivolo  
 Reibe, Rutschfestes Griff  
 Râpe queue antidérapant  
 Rallador mango antiderrapante

art. cm. l. cm.

42560-09 7,7x13,3 30



**Spatzle sieve**  
 Grattugia per spatzle  
 Spätzle-Reibe  
 Grille à spatzle  
 Rallador para spatzle

art. cm.

49844-01 31x10,5x6



**Nutmeg grater**  
 Grattugia noce moscata  
 Muskatreibe  
 Râpe à muscade  
 Rallador nuez moscada

art. cm.

42556-00 4,5x14



**4-ways grater**  
 Grattugia 4 tagli  
 Vierkantreibe  
 Râpe 4 faces  
 Rallador 4 caras

art. cm.

42569-04 10x8x23



PP

**Dumplin maker**

Stampo panzerotti  
Knödel-Form  
Moule à chaussons  
Molde para empanadillas

art. mm.  
49843-05 62, 82, 104, 177



**Safety can opener**

Apriscatole sicuro  
Sicherheitsdosenöffner  
Ouvre-boîte de sûreté  
Abrelatas de seguridad

art. cm.  
48222-01 12,5x8



**Universal can opener**

Apriscatole universale, nichelato  
Universal-Dosenöffner  
Ouvre-boîte, universel  
Abrelatas universal

art. cm.  
48220-00 8x7



**Can opener, PP handle**

Apriscatole, impugnatura PP  
Dosenöffner, Griffe aus PP  
Ouvre-boîte, poignées PP  
Abrelatas, mango PP

art. l. cm.  
48280-03 21



SS

**Electric sieve**

Passaverdura elettrico  
Elektropassiergerät  
Moulin électrique  
Molino eléctrico

art. Ø cm. h. kg./H Kg.  
49879-37 37 108 300 23,5

Equipped with 3 mm disc. – Griglia 3 mm.



**Sieve on tripod, tinned**

Passaverdura stagnato con supporto  
Passiergerät, verzinkt, mit Träger  
Moulin étamé sur pied  
Molino estañado sobre pie

art. Ø cm. h. Kg.  
42577-39 39 80 14

Equipped with 3 mm disc. – Griglia 3 mm.



**Tomato juicer sieve**

Passapomodori, professionale  
Profi-Tomatenpassiergerät  
Moulin à tomates professionnel  
Molino para tomates, profesional

art. Ø cm. h.  
42576-00 21 50

Equipped with 1 mm disc. – Griglia 1 mm.



SS

**Herb mill**

Macinaerbe  
Kräutermühle  
Moulin fines herbes  
Molino de hierbas finas

art. cm.  
42558-00 7x22



SS

**Sieve, 3 discs**

Passaverdura, 3 griglie  
 Passiergerät, 3 Roste  
 Moulin inox, 3 grilles  
 Molino inox, 3 rejillas

art.	Ø cm.	h.	Kg.
42571-20	19	16,5	0,46
42572-24	24	16,5	0,82

**Discs: 1,5 - 2 - 4 mm. – Griglie: 1,5 - 2 - 4 mm.**



SS

**Sieve, 3 discs**

Passaverdura, 3 griglie  
 Passiergerät, 3 Roste  
 Moulin inox, 3 grilles  
 Molino inox, 3 rejillas

art.	Ø cm.	h.	Kg.
42570-32	31	25	1,4

**Discs: 1,5 - 2,5 - 4 mm. – Griglie: 1,5 - 2,5 - 4 mm.**



**Sieve, tinned, 3 discs**

Passaverdura stagnato, 3 griglie  
 Passiergerät, verzinkt, 3 Roste  
 Moulin étamé, 3 grilles  
 Molino estañado, 3 rejillas

art.	Ø cm.	h.	Kg.
42573-31	31	25	1,4

**Discs: 1,5 - 2,5 - 4 mm. – Griglie: 1,5 - 2,5 - 4 mm.**



SS

**Sieve, 1 disc**

Passaverdura, 1 griglia  
 Passiergerät, 1 Rost  
 Moulin inox, 1 grille  
 Molino inox, 1 rejilla

art.	Ø cm.	h.	Kg.
42574-37	37	32	3,5

**Equipped with 3 mm disc. – Griglia 3 mm.**



**Sieve, tinned, 1 disc**

Passaverdura stagnato, 1 griglia  
 Passiergerät, verzinkt, 1 Rost  
 Moulin étamé, 1 grille  
 Molino estañado, 1 rejilla

art.	Ø cm.	h.	Kg.
42575-37	37	32	3,5

**Equipped with 3 mm disc. – Griglia 3 mm.**



42570 - 42573

42574 - 42575  
 42577 - 49879



NEW

SS

**Bottles and cans press**

Pressa bottiglie e lattine  
 Flaschen und Dosen Presse  
 Presse bouteilles et boîtes  
 Prensa botellas y latas

art.	cm.
49815-00	13,5x12x50

**To crush cans and plastic bottles. All cans. Bottles up to 2.5 l. – Per tutti tipi di lattine e per bottiglie di plastica fino a 2,5 l.**





**NEW**  
**SS**

**Table top can opener**  
Apriscatole da banco  
Tisch-Dosenöffner  
Ouvre-boîte  
Abrelatas

art. cm. Kg.  
49867-01 28x12,2x77,5 5

**With screw base. Patented opening system. Opens round cans any sizes securely from 8 to 50 cm height), leaves smooth and not sharp edges. The cap can be reused. Dishwasher safe.**  
Base da avvitare. Sistema di apertura brevettato. Per scatole rotonde di tutte le dimensioni (h da 8 a 50 cm). Rifilo netto dei bordi esterni. Nessun rischio di taglio. Possibilità di riutilizzare il coperchio dalla scatola. Lavabile in lavastoviglie.



**NEW**  
**SS**

**Table top can opener**  
Apriscatole da banco  
Tisch-Dosenöffner  
Ouvre-boîte  
Abrelatas

art. cm. Kg.  
49867-02 28x12,2x77,5 5

**With clamp base. Patented opening system. Opens round cans any sizes securely from 8 to 50 cm height), leaves smooth and not sharp edges. The cap can be reused. Dishwasher safe.**  
Base con morsetto. Sistema di apertura brevettato. Per scatole rotonde di tutte le dimensioni (h da 8 a 50 cm). Rifilo netto dei bordi esterni. Nessun rischio di taglio. Possibilità di riutilizzare il coperchio dalla scatola. Lavabile in lavastoviglie.



**Table top can opener**  
Apriscatole da banco  
Tisch-Dosenöffner  
Ouvre-boîte  
Abrelatas

art. l. cm.  
19810-00 56

**Can size up to height 45 cm. Clamp base and bar in die-cast aluminum, steel head. Table fixing either with screws or clamp. – Altezza scatola fino a 45 cm. Corpo in alluminio pressofuso, testa in acciaio, fissaggio a viti o morsetto.**



**Table top can opener, steel**  
Apriscatole da banco, acciaio  
Tisch-Dosenöffner, Stahl  
Ouvre-boîte, acier  
Abrelatas, acero

art. l. cm.  
49811-00 40

**Can size up to height 30 cm. Table fixing with clamp base. – Altezza scatola fino a 30 cm. Fissaggio a morsetto.**



**SS**

**Table top can opener**  
Apriscatole da banco  
Tisch-Dosenöffner  
Ouvre-boîte  
Abrelatas

art. l. cm.  
49812-00 55

**Can size up to height 40 cm. Table fixing with clamp base. – Altezza scatola fino a 40 cm. Fissaggio a morsetto.**



**SS**

**Electric can opener**  
Apriscatole elettrico  
Elektrodosenöffner  
Ouvre-boîte électrique  
Abrelatas eléctrico

art. cm. Kg.  
49814-00 44x25x75 13

**Dual speed motor. Opens all can shapes from 50 to 270 mm height. – Motore a 2 velocità. Per tutti i formati di scatola da 50 a 270 mm di altezza.**





# THERMOMETERS TERMOMETRI

KITCHEN UTENSILS  
UTENSILI DA CUCINA





SS

**Meat roasting thermometer**

Termometro arrosti  
Braten-Thermometer  
Thermomètre à rôtir  
Termómetro asado

art.	Ø cm.	scala	range
49705-00	4,5	1°C	0+120°C

**Penetration probe 13 cm. – Sonda l. 13 cm.**



SS

**Meat roasting thermometer**

Termometro arrosti  
Braten-Thermometer  
Thermomètre à rôtir  
Termómetro asado

art.	Ø cm.	range
19705-00	5	+54+88°C



SS

**Cooking & frying thermometer**

Termometro fritti  
Back-Thermometer  
Thermomètre à friture  
Termómetro frituras

art.	Ø cm.	scala	range
19706-00	5	10°C	+38+205°C

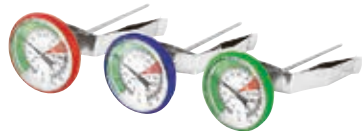

NEW

SS

**Milk frothing thermometers, 3 pcs**

Termometri latte/barista, 3 pz  
Mich-Thermometer, 3 Stk  
Thermomètres à lait, 3 pièces  
Termómetros leche, 3 pz

art.	Ø cm.	scala	range
49709-03	4,5	1°C	-10+110°C

**Red, green and blue, to easily identify different types of milk used, to avoid cross-contamination. Stem 175 mm. – Rosso, verde e blu, per identificare facilmente i diversi tipi di latte utilizzati, per evitare la contaminazione incrociata. Stelo 175 mm.**



**Sugar thermometer**

Termometro per zucchero  
Zuckerthermometer  
Thermomètre à sucre  
Termómetro azúcar

art.	l. cm.	scala	range
47843-00	30	1°C	+80+200°C

**Stainless steel housing. – Guaina inox.**



NEW

**Sugar/jam thermometer**

Termometro per zucchero/marmellata  
Zucker- und Marmeladenthermometer  
Thermomètre à sucre et confiture  
Termómetro azúcar y mermelada

art.	scala	range
47843-05	2°C	+40+200°C

**Brass. – Ottone. Dim. 4,7x20 cm.**



**Baker's thermometer**

Termometro per panettiere  
Bäckerthermometer  
Thermomètre boulanger  
Termómetro panadero

art.	l. cm.	scala	range
49712-00	30	1°C	-10+60°C

**Plastic housing. – Guaina plastica.**



SS

**Oven thermometer**

Termometro per forno  
Ofenthermometer  
Thermomètre à four  
Termómetro horno

art.	Ø cm.	scala	range
19709-00	7	10°C	+38+316°C



ABS

**Fridge/freezer thermometer**

Termometro frigo/freezer  
Kühlschrank-Thermometer  
Thermomètre à réfrigérateur  
Termómetro congelador

art.	Ø cm.	scala	range
49885-02	7	1°C	-50+50°C



SS

**Fridge/freezer thermometer**

Termometro frigo/freezer  
Kühlschrank-Thermometer  
Thermomètre à réfrigérateur  
Termómetro congelador

art.	Ø cm.	scala	range
19702-00	6	1°C	-29+27°C



ABS

**Digital thermometer**

Termometro digitale  
Digitalthermometer  
Thermomètre digitale  
Termómetro digital

art.	scala	range
49887-00	0,1°C	-50+70°C

Dim. cm. 1,5x5x7



NEW

ABS

**Digital fridge thermometer**

Termometro digitale per frigorifero  
Kühlschrank-Digitalthermometer  
Thermomètre digitale à réfrigérateur  
Termómetro digital para refrigerador

art.	scala	range
49887-02	0,1°C	-9,9+49,9°C

**Dim. Cm. 2,6x4,5x7,3. Water resistant IP65. Features a food safety zone icon in the display that indicates when the temperature is outside the range of 0 to 5°C. – Resistente all'acqua IP65. Un'icona indica sul display quando la temperatura è al di fuori dell'intervallo da 0 a 5°C.**



**Room/wall thermometer**

Termometro da muro  
Wandthermometer  
Thermomètre à mur  
Termómetro de pared

art.	scala	range
49702-00	1°C	-30+50°C

Dim. cm. 20,5x4. Without mercury. Senza mercurio.



**Pocket thermometer**

Termometro da tasca  
Taschenthermometer  
Thermomètre à poche  
Termómetro digital

art.	l. cm.	scala	range
19701-00	15	0,1°C	-50+150°C



**Digital thermometer**

Termometro digitale  
Digitalthermometer  
Thermomètre digitale  
Termómetro digital

art.	scala	range
49710-00	1°C	-50+300°C

Probe 135 mm. ø 2,5 mm.  
Sonda 135 mm. ø 2,5 mm.



**Pocket thermometer**

Termometro da tasca  
Taschenthermometer  
Thermomètre à poche  
Termómetro digital

art.	scala	range
49701-00	0,1°C	-50+200°C

Probe 125 mm. ø 3,5 mm.  
Sonda 125 mm. ø 3,5 mm.



**Digital thermometer**

Termometro digitale  
Elektronisches Thermometer  
Thermomètre digital  
Termómetro digital

art. scala range  
49715-00 0,1°C -50+300°C

**Probe 125 mm. ø 3,5 mm.**  
Sonda 125 mm. ø 3,5 mm.



**Digital thermometer**

Termometro digitale  
Elektronisches Thermometer  
Thermomètre digital  
Termómetro digital

art. scala range  
49716-00 0,1°C -50+300°C

**Dim. cm. 1,9x7x15,2. Countdown/up 99h-59m.**



**Digital thermometer**

Termometro digitale  
Elektronisches Thermometer  
Thermomètre digital  
Termómetro digital

art. scala range  
49883-00 0,1°C -50+300°C

**Dim. cm. 13x5,5x2,5. Probe 13 cm. ABS case incl. Biomaster AT.** – Involucro ABS con Biomaster. Sonda 13 cm.



**Multi-function thermometer**

Termometro multifunzione  
Multifunktions-Thermometer  
Thermomètre multifonction  
Termómetro multifunción

art. scala range  
49988-00 0,1°C -19,9+149,9°C

**Dim. cm. 2,5x7,3x12,3. Probe 125 mm. ø 3,5.**  
**Housing & probe handle incl. Biomaster AT.**  
Involucro e manico sonda con Biomaster. Sonda 125 mm. ø 3,5.



**Infrared thermometer**

Termometro a infrarossi  
Infrarot-Thermometer  
Thermomètre infrarouge  
Termómetro infrarrojo

art. scala range  
49986-00 0,1°C -49,9+349,9°C

**Dim. cm. 2,5x5,2x10**



**Infrared thermometer**

Termometro a infrarossi  
Infrarot-Thermometer  
Thermomètre infrarouge  
Termómetro infrarrojo

art. scala  
49884-08 0,1/1°C

**Dim. cm. 4x6,6x15,5. Range infrared-Infrarossi: -60 to 500°C – Range probe-Sonda: -64 to 1370°C.**



**Infrared thermometer**

Termometro a infrarossi  
Infrarot-Thermometer  
Thermomètre infrarouge  
Termómetro infrarrojo

art. scala range  
49717-00 1°C -50+400°C

**Dim. cm. 17,5x4x7,2**



**Infrared thermometer**

Termometro a infrarossi  
Infrarot-Thermometer  
Thermomètre infrarouge  
Termómetro infrarrojo

art. scala range  
49987-00 0,1°C -50+330°C

**Dim. cm. 3,6x8,8x13,1**



**NEW**

**Waterproof thermometer**

Termometro waterproof  
Waterproof-Thermometer  
Thermomètre waterproof  
Termómetro waterproof

art. scala range  
49711-00 0,1°C -50+300°C

**Dim. Ø 51x178 mm. Waterproof IP66. Auto-rotating display. S/steel penetration probe Ø 2,5x70 mm stainless steel, Ø 1,6 mm tip.**  
Impermeabile IP66. Display a rotazione automatica. Sonda di penetrazione inox Ø 2,5x70 mm., punta Ø 1,6 mm.



**Spatula with thermometer**  
Spatola con termometro  
Rührspaten mit Thermometer  
Spatule avec thermomètre  
Espátula con termómetro

art. range  
49729-00 -50+300°C

Dim. cm. 26x4x1,8



**Digital thermometer**  
Termometro digitale  
Elektronisches Thermometer  
Thermomètre digital  
Termómetro digital

art.	scala	range	col.
49880-10	0,1/1°C	-49,9+299,9°C	●
49880-11	0,1/1°C	-49,9+299,9°C	●
49880-12	0,1/1°C	-49,9+299,9°C	●

Dim. cm. 1,9x5x15,7. S/s probe Ø 3,3 x 115 mm. folds back through 180°.



**Digital thermometer**  
Termometro digitale  
Elektronisches Thermometer  
Thermomètre digital  
Termómetro digital

art.	scala	range	col.
49880-13	0,1/1°C	-49,9+299,9°C	●
49880-14	0,1/1°C	-49,9+299,9°C	●
49880-15	0,1/1°C	-49,9+299,9°C	○

Sonda inox ø 3,3 x 115 mm. pieghevole a 180°.



**Sous vide cooking thermometer**  
Termometro per sottovuoto  
Vakuüm-Koch-Thermometer  
Thermomètre pour cuisson sous-vide  
Termómetro cocción al vacío

art.	scala	range
49881-01	0,1°C	-99,9+299,9°C
	1°C	+300+1372°C

Kit: thermometer, Sous-Vide needle probe 60 mm., one metre foam/tape, zip pouch, free traceable certificate of calibration.

Kit: termometro, sonda per sottovuoto 60 mm., 1 metro di nastro adesivo, astuccio con zip, certificato di calibrazione tracciabile.



NEW

**Sous vide cooking thermometer**  
Termometro per sottovuoto  
Vakuüm-Koch-Thermometer  
Thermomètre pour cuisson sous-vide  
Termómetro cocción al vacío

art.	scala	range
49881-11	0,1°C	-49.9+299.9°C
	0,50%	0>40% TPM

Dim. 1,9x4,7x15,3 cm. S/steel needle probe Ø 1,1 x 60 mm. FREE traceable certificate of calibration incl. – Sonda ad ago inox Ø 1,1 x 60 mm. Certificato di calibrazione incl.



NEW

**Sous vide foam tape**  
Nastro adesivo per sottovuoto  
Vakuümschaumklebeband  
Ruban adhésif pour sous-vide  
Cinta adhesiva para cocción al vacío

art.	l. cm.
49881-99	100

Used in conjunction with thermometer to measure the core temperature without suffering water ingress into vacuum sealed bag.

Utilizzato in combinazione con il termometro evita che penetri acqua nel sacchetto sotto vuoto.



**ABS**

**Digital oven thermometer**  
Termometro digitale da forno  
Ofen-Digitalthermometer  
Thermomètre à four digital  
Termómetro horno digital

art. Ø cm. scala range  
49719-00 8 1°C/F -50+300°C

**Loud 70dB audible temperature alarm. 114 mm probe with 1,2 metre s/s braided lead that allows the probe to remain in the food during cooking. Water/dust resistance: IP65 protection.**

Allarme acustico 70dB. Sonda 114 mm., cavo inox 1,2 metri che permette l'utilizzo durante la cottura. Resistenza acqua/polvere. IP65.



**Oven timer, cooking thermometer**  
Timer, termometro da forno  
Digitalkochalarm  
Minuterie digitale  
Reloj, termómetro digital

art. scala range  
49718-00 1°C 0+300°C

**Dim. cm. 13x7,5x2. Count down/up from/to 23h 59m 59sec. High temperature probe cm 15 ø 4 mm. S/s braided lead 2 metres.**

Timer 23h 59min 59sec. Sonda ad alta temperatura 15 cm ø 4 mm. Cavo 2 metri .



**Waterproof digital timer**  
Timer digitale a tenuta stagna  
Wasserdichte Digitaltimer  
Timer digital étanche  
Reloj digital impermeable

art. Ø cm. h.  
49733-00 8 17

**99M-99S. Dust and flour proof. Sound and flashing alarms. Hanging hook and suction cup.**

A prova di polvere e farina. Suono e allarme lampeggiante. Gancio e ventosa.



**Digital timer**  
Timer digitale  
Digitalkochalarm  
Minuterie digitale  
Reloj digital

art. cm.  
49720-00 7x5,5

**Timer 23H-59M-59S. Clock 12H AM/PM. Count down. 80dB audible alarm. Magnetic pad.**

Orologio 12H AM/PM. Cronometro. Allarme acustico 80dB. Attacco magnetico.



**Digital timer**  
Timer digitale  
Digitalkochalarm  
Minuterie digitale  
Reloj digital

art. cm.  
49734-00 9x4,7x4,5

**Count-down/up: 23H 59M 59S. 80 dB sound. 1 AAA battery.**



**Digital timer jumbo**  
Timer digitale gigante  
Digitalkochalarm jumbo  
Minuterie digitale géante  
Reloj digital gigante

art. cm.  
49735-00 13,5x9,5x16

**4 possible programs. Electrical plug & battery. Waterproof front panel IP54. 80 dB sound. 6F22 battery.**



**NEW**

**ABS**

**Thermohygrometer with clock**  
Termoigrometro con orologio  
Thermohygrometer mit Uhr  
Thermohygromètre avec horloge  
Termohigrómetro con reloj

art. cm. range  
49721-03 13x10x2,5 -20+50°C

**10-99% RH - 12/24 H.**



**Syrup density meter**  
Pesa sciroppo, densimetro  
Sirup-Hydrometer  
Pèse-sirop  
Aerómetro

art. l. cm.  
49703-00 12,5

**g/ml/°Bé: 1.100-1.400/15-40 - °C20 - Div.: 0,010 g/ml/2°Bé.**



**Hydrometer for brine and salt**  
Densimetro per salamoia e sale  
Hydrometer für Sole und Salz  
Densimètre pour saumure et sel  
Hidrómetro salmuera y sal

art. l. cm.  
49730-20 19,5

**g/ml/°Bé: 1.000-1.250/0-30 - °C20 - Div.: 0,001 g/ml/2°Bé.**



ABS  
PP

**Salt tester and thermometer**

Salinometro e termometro  
Salzgehalt-Meter u. Thermometer  
Testeur de salinité et thermometer  
Salinometro y termómetro

art. cm.

49730-00 3,2x1,6x22,5

To measure the salt content of food and liquids in percentage from 0 to 5%. Temperature from 0°+100°C. – Per misurare il tenore di sale in alimenti e liquidi in percentuale da 0 a 5%. Temperatura da 0°+100° C.



NEW

**Frying oil test strips**

Strisce reattive per oli di frittura  
Bratöl-Teststreifen  
Bandes réactives pour les huiles de friture  
Tiras reactivas para control aceites

art.

49731-99

Storage bottles of 100 Oil Quality Test Strips and easy to read colour chart. Hold the test strip in the oil for 2 seconds (max 40°C), then remove it and wait 2 minutes, next, compare the strip to the colour chart. – Flacone con 100 strisce reattive e tabella colori di facile lettura. Immergere la fascia colorata della striscia nell'olio (max. 40°C) per 2 secondi, quindi rimuoverla e attendere 2 minuti. Confrontare la striscia con la tabella colori.



NEW  
ABS  
SS

art. range pairs/paia

49723-00 0,1°C +30+200°C

Dim. 3,1x4,8x36,5 cm. Suitable for measuring olive oil, palm oil, rapeseed oil, peanut oil, soybean oil, sesame oil, vegetable oils and animal fats – Adatto per misurare olio di oliva, palma, colza, arachidi, soia, sesamo, oli vegetali e grassi animali.



**Frying oil tester**

Test degradazione oli di frittura  
Kontrollsystem für Bratenöle  
Test dégradation des huiles de friture  
Test para control aceites

art.

49731-10

Consisting of two reagents that are not harmful to health and environmentally friendly. For 20 tests. ATTENTION: works with all types and brands of frying oil, (except with palm oil). – Composto da due reagenti non nocivi per la salute e rispettosi dell'ambiente. Per 20 test. ATTENZIONE: funziona con tutti i tipi e le marche di olio di frittura, (tranne che con l'olio di palma).



- 😊 NEW OIL <9% of polar compounds  
OLIO NUOVO <9% di composti polari
- 😊 GOOD OIL from 10 to 16% of polar compounds  
OLIO BUONO da 10 a 16% di composti polari
- 😞 DETERIORATED OIL from 17 to 23% of polar compounds  
OLIO DETERIORATO da 17 a 23% di composti polari
- 😡 OIL TO CHANGE >24% of polar compounds  
OLIO DA CAMBIARE >24% di composti polari



**Labels solvable**

Etichette dissolvibili  
Lösbare Etiketten  
Etiquettes solubles  
Etiquetas solubles

art. cm. pcs/pz

44630-01 7,5x4 250

Dissolvable in less than 20 seconds. Suitable for any type of surface. – Dissolvibili in meno di 20 secondi. Adatte a qualsiasi tipo di superficie.



**Labels 14 allergens**

Etichette 14 allergeni  
Etiketten 14 Allergene  
Etiquettes 14 allergènes  
Etiquetas 14 alérgenos

art. cm. pcs/pz  
44630-02 7,5x4 500

**Labels with all 14 allergens pre-printed.**  
Etichette con i 14 allergeni prestampati.



**Labels Express 7 days**

Etichette express 7giorni  
Etiketten Express 7 Tage  
Etiquettes express 7 jours  
Etiquetas express 7 dias

art. cm. pcs/pz  
44630-03 3x2,5 1750

**Different colors based on the day of the week.**  
**Data to be written: product description; date of production or expiry date.** – Diversi colori in base al giorno della settimana. Dati da inserire: descrizione del prodotto; data di produzione o data di scadenza.



**NEW**

**Labels frozen food**

Etichette frozen/surgelati  
Etiketten Tiefkühlkost  
Etiquettes aliments surgelés  
Etiquetas alimentos congelados

art. cm. pcs/pz  
44630-04 7x4,5 500



**NEW**

**Labels TMC**

Etichette TMC  
Etiketten TMC  
Etiquettes TMC  
Etiquetas TMC

art. cm. pcs/pz  
44630-05 7x4,5 500

**TMC: Termine minimo di conservazione.**

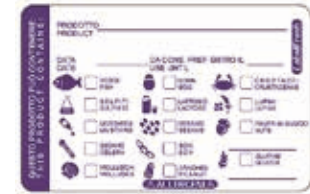

**NEW**

**Labels Allergens**

Etichette allergeni  
Etiketten Allergene  
Etiquettes allergènes  
Etiquetas alérgenos

art. cm. pcs/pz  
44630-06 7x4,5 500



**NEW**

**Labels delivery with allergens**

Etichette delivery con allergeni  
Etiketten Lieferung mit Allergenen  
Etiquettes livraison avec allergènes  
Etiquetas entrega con alérgenos

art. cm. pcs/pz  
44630-07 14x4,5 250



**Wall clock ORION**

Orologio da parete  
Wanduhr  
Horloge à pari  
Reloj de pared

art. Ø cm.  
41380-01 29

**Satin alloy.** – Metallo satinato.



**ABS**



**Wall clock SILENT**

Orologio da parete  
Wanduhr  
Horloge à pari  
Reloj de pared

art. Ø cm.  
41380-02 30,5

**Silent clock.** – Movimento silenzioso.





ABS

SS

**Digital scale**

Bilancia digitale  
Präzisionswaage  
Balance digitale  
Balanza digital

art.	cm.	Kg.	scala
49865-06	21,6x17,1x6,3	6	1g

**Antimicrobial protection. Portion count. Removable platform cm 14,6x16,5. AC adapter/batteries supply.** – Protezione antimicrobica. Conteggio porzioni. Piattaforma cm 4,6x16,5. Adattatore AC/batterie.



**Digital scale**

Bilancia digitale  
Präzisionswaage  
Balance digitale  
Balanza digital

art.	cm.	Kg.	scala
49865-70	30,5x31,8x5,7	68	100g

**Platform cm 30,5x30,5. Remote LCD wall mount display. Electric or batteries supply.** Piattaforma cm 30,5x30,5. Schermo LCD rimovibile per montaggio a parete. Alimentazione corrente/batteria.



SS

**Mechanical scale**

Bilancia meccanica  
Waage  
Balance  
Balanza

art.	Ø cm.	Kg.	scala
49864-03	20	3	10g
49864-05	20	5	20g



SS

**Mechanical scale**

Bilancia meccanica  
Waage  
Balance  
Balanza

art.	Ø cm.	Kg.	scala
49864-20	25	20	100g



SS

**Digital kitchen scale**

Bilancia digitale da cucina  
Digital-Küchenwaage  
Balance de cuisine  
Balanza digital de cocina

art.	cm.	Kg.	scala
49773-05	21,5x13	5	1g



NEW

SS

ABS

**Digital kitchen scale**

Bilancia digitale da cucina  
Digital-Küchenwaage  
Balance de cuisine  
Balanza digital de cocina

art.	cm.	Kg.	scala
49774-05	22,5x16,5x2	5	1g



**Pocket scale**

Bilancia tascabile  
Taschenwaage  
Balance de poche  
Balanza de bolsillo

art.	cm.	Kg.	scala
49771-00	15x10x2,5	0,25	0,1 g



NEW

SS

ABS

**Pocket scale**

Bilancia tascabile  
Taschenwaage  
Balance de poche  
Balanza de bolsillo

art.	cm.	Kg.	scala
49772-01	12,7x7,6x2	1	0,1 g



ABS  
SS

**Digital scale**  
Bilancia digitale  
Digitalwaage  
Balance digitale  
Bilancia digital

art.	cm.	Kg.	scala
49775-05	24,5x31x9,5	5	1g
49775-10	24,5x31x9,5	10	1g



ABS  
SS

**Digital scale**  
Bilancia digitale  
Digitalwaage  
Balance digitale  
Bilancia digital

art.	cm.	Kg.	scala
49777-50	29x33,5x11	50	1g

Unit: Kg/lb.



SS

**Digital scale**  
Bilancia digitale  
Digitalwaage  
Balance digitale  
Bilancia digital

art.	cm.	Kg.	scala
49776-15	24x29x11	15	1g
49776-30	24x29x11	30	2g



ABS  
SS

**Digital scale with platform**  
Bilancia digitale con piattaforma  
Digitalwaage mit Plattform  
Balance digitale avec plate-forme  
Bilancia digital con plataforma

art.	cm.	Kg.	scala
49779-15	50x40x84	150	20g
49779-30	60x50x84	300	50g



# SERIES 18100

FORGED KNIVES  
COLTELLI FORGIATI



A deep study and computerised tests of ergonomics, movement and posture have allowed Paderno to create a professional knives line, that is the synthesis of comfort and cutting precision. Handle made of plastic specially developed for the food processing sector, ergonomic design with soft edges, perfect grip to ensure precise guidance. The forged blade realised in special steel and molybdenum/vanadium, thanks to a peculiar hardening process, guarantees to the product a perfect cut and a long life of the blade's edge.

Uno studio approfondito e prove computerizzate di ergonomia, movimento e postura hanno permesso a Paderno di creare una linea di coltelli professionali, sintesi perfetta tra comfort e perfezione del taglio. Manico realizzato in speciale materiale plastico sviluppato per il settore alimentare, design ergonomico con bordi arrotondati, presa perfetta per garantire un taglio di precisione. Lama forgiata realizzata in lega di speciale acciaio, molibdeno e vanadio con particolare processo di tempra che garantisce al prodotto un ottimo taglio ed una perfetta e lunga tenuta di filo.



**Cook's knife**

Coltello cucina  
Kochmesser  
Couteau cuisine  
Cuchillo de cocinero

art.	cm.
18100-16	16
18100-20	20
18100-24	24
18100-30	30
18100-36	36



**Butcher's knife**

Coltello francese  
Kochmesser  
Couteau de chef  
Cuchillo de carnicero

art.	cm.
18102-16	16
18102-20	20
18102-26	26
18102-30	30



**Oriental cook's knife**

Coltello cucina orientale  
Japanisches Kochmesser  
Couteau de chef style japonais  
Cuchillo cocinero japonés

art.	cm.
18103-18	18



**Oriental cook's knife, dimpled ground**

Coltello cucina orientale, alveolato  
Japanisches Kochmesser mit Kullenschliff  
Couteau de chef style japonais alveolé  
Cuchillo cocinero japonés, con alvéolos

art.	cm.
18104-18	18



**Slicer**

Coltello affettare  
Fleischmesser  
Tranchelard  
Cuchillo para filetear

art.	cm.
18106-15	15
18106-20	20
18106-25	25
18106-30	30



**Ham knife**

Coltello prosciutto  
Schinkenmesser  
Trancheur à rôti  
Cuchillo para jamón

art.	cm.
18109-26	26
18109-30	30
18109-36	36



**Ham knife, dimpled ground**

Coltello prosciutto, alveolato  
Schinkenmesser mit Kullenschliff  
Couteau à rôti alvéolé  
Cuchillo para jamón, con alvéolos

art.	cm.
18110-26	26
18110-30	30
18110-36	36



**Salmon knife**

Coltello salmone  
Lachsmesser  
Couteau à saumon  
Cuchillo para salmón

art.	cm.
18111-30	30



**Salmon knife, dimpled ground**

Coltello salmone, alveolato  
Lachsmesser mit Kullenschliff  
Couteau à saumon alvéolé  
Cuchillo para salmón, con alvéolos

art.	cm.
18112-30	30



**Carving knife**

Coltello trinciante  
Filiermesser  
Couteau à découper  
Cuchillo para trincar

art.	cm.
18114-20	20



**Filleting, flexible**

Coltello filettare, flessibile  
Filiermesser, flexibel  
Filet de sole, flexible  
Cuchillo para filetear, flexible

art.	cm.
18115-20	20
18115-25	25



**Boning knife**

Coltello disosso  
Ausbeinmesser  
Couteau à désosser  
Cuchillo para deshuesar

art.	cm.
18116-14	14
18116-18	18



**Steak knife**

Coltello bistecca  
Steakmesser  
Couteau à steak  
Cuchillo para steak

art.	cm.
18122-12	12



**Paring knife**

Spelucchino  
Spickmesser  
Couteau d'office  
Cuchillo mondador

art.	cm.
18124-09	9



**Paring knife**

Spelucchino  
Spickmesser  
Couteau d'office  
Cuchillo mondador

art.	cm.
18125-07	7
18125-10	10



**Bent paring knife**

Coltello cuoco  
Tourniermesser  
Bec d'oiseau  
Cuchillo verdura

art.	cm.
18126-07	7



**Table knife**

Coltello tavola  
Allzweckmesser  
Couteau bout rond cranté  
Cuchillo para mesa

art.	cm.
18123-11	11



**Bread knife**

Coltello pane  
Brotmesser mit Wellenschliff  
Couteau à pain ondulé  
Cuchillo para pan

art.	cm.
18128-20	20
18128-24	24
18128-30	30



**Meat fork**

Forchettone  
Fleischgabel  
Fourchette diapason  
Tenedor para carne

art.	cm.
18230-13	13
18230-17	17



**Carving fork curved**

Forchettone curvo  
Fleischgabel  
Fourchette à viande  
Tenedor curvo para carne

art.	cm.
18231-13	13



# SERIES 18000

STAMPED KNIVES  
COLTELLI TRANCIATI



The professional cutlery line “Color-Line” helps to reduce the risk of cross contamination using a Color Coding System which identifies each knife with a specific task: different food processing areas are easily identified. The steel used for this cutlery line has exceptional hardness and very high resistance to corrosion due to ICE-HARDENED system, a special process to harden the steel.

La linea di coltelleria professionale “CCS”– Color Coding System riduce i rischi di contaminazione incrociata grazie all'utilizzo di un Sistema di Codifica dei Colori che identifica ogni coltello per un uso specifico e permette di individuare facilmente le diverse aree di lavoro. Gli acciai utilizzati per questa linea di coltelleria presentano un'eccezionale durezza ed elevata resistenza alla corrosione, grazie all'uso del sistema ICE-HARDENING, processo speciale per temprare l'acciaio.



**Cook's knife**

Coltello cucina  
Kochmesser  
Couteau cuisine  
Cuchillo de cocinero

art.	cm.	col.
18000-16	16	●
18000-20	20	●
18000-23	23	●
18000-26	26	●
18000-30	30	●
18000-36	36	●



**Cook's knife**

Coltello cucina  
Kochmesser  
Couteau cuisine  
Cuchillo de cocinero

art.	cm.	col.
18000B16	16	●
18000B20	20	●
18000B23	23	●
18000B26	26	●
18000B30	30	●



**Cook's knife**

Coltello cucina  
Kochmesser  
Couteau cuisine  
Cuchillo de cocinero

art.	cm.	col.
18000G16	16	●
18000G20	20	●
18000G23	23	●
18000G26	26	●
18000G30	30	●



**Cook's knife**

Coltello cucina  
Kochmesser  
Couteau cuisine  
Cuchillo de cocinero

art.	cm.	col.
18000M16	16	●
18000M20	20	●
18000M23	23	●
18000M26	26	●



**Cook's knife**

Coltello cucina  
Kochmesser  
Couteau cuisine  
Cuchillo de cocinero

art.	cm.	col.
18000R16	16	●
18000R20	20	●
18000R23	23	●
18000R26	26	●
18000R30	30	●



**Cook's knife**

Coltello cucina  
Kochmesser  
Couteau cuisine  
Cuchillo de cocinero

art.	cm.	col.
18000W20	20	○
18000W26	26	○
18000W30	30	○



**Cook's knife**

Coltello cucina  
Kochmesser  
Couteau cuisine  
Cuchillo de cocinero

art.	cm.	col.
18000Y16	16	●
18000Y20	20	●
18000Y23	23	●
18000Y26	26	●



**Butcher's knife**

Coltello scimitarra  
Blockmesser  
Couteau à découper  
Cuchillo de carnicero

art.	cm.	col.
18005-22	22	●
18005-27	27	●
18005-32	32	●



**Butcher's knife**

Coltello scimitarra  
Blockmesser  
Couteau à découper  
Cuchillo de carnicero

art.	cm.	col.
18005B22	22	●
18005B27	27	●
18005B32	32	●



**Butcher's knife**

Coltello scimitarra  
Blockmesser  
Couteau à découper  
Cuchillo de carnicero

art.	cm.	col.
18005G22	22	●
18005G27	27	●
18005G32	32	●



**Butcher's knife**

Coltello scimitarra  
Blockmesser  
Couteau à découper  
Cuchillo de carnicero

art.	cm.	col.
18005R22	22	●
18005R27	27	●
18005R32	32	●



**Butcher's knife**

Coltello scimitarra  
Blockmesser  
Couteau à découper  
Cuchillo de carnicero

art.	cm.	col.
18005Y22	22	●
18005Y27	27	●
18005Y32	32	●



**Butcher's knife**

Coltello francese  
Schlachtsmesser  
Couteau à découper  
Cuchillo carnicero francés

art.	cm.	col.
18002-18	18	●
18002-20	20	●
18002-22	22	●
18002-26	26	●
18002-30	30	●
18002-36	36	●



**Butcher's knife**

Coltello francese  
Schlachtsmesser  
Couteau à découper  
Cuchillo carnicero francés

art.	cm.	col.
18002B26	26	●



**Butcher's knife**

Coltello francese  
Schlachtsmesser  
Couteau à découper  
Cuchillo carnicero francés

art.	cm.	col.
18002R18	18	●
18002R20	20	●
18002R22	22	●
18002R26	26	●
18002R30	30	●
18002R36	36	●



**Butcher's knife**

Coltello francese  
Schlachtsmesser  
Couteau à découper  
Cuchillo carnicero francés

art.	cm.	col.
18002Y18	18	●
18002Y26	26	●
18002Y30	30	●
18002Y36	36	●





**Slicer knife**

Coltello affettare  
Wurstmesser  
Couteau à jambon  
Cuchillo para filetear

art.	cm.	col.
18006-20	20	●
18006-25	25	●
18006-30	30	●
18006-36	36	●



**Slicer knife**

Coltello affettare  
Wurstmesser  
Couteau à jambon  
Cuchillo para filetear

art.	cm.	col.
18006B20	20	●
18006B25	25	●
18006B30	30	●



**Slicer knife**

Coltello affettare  
Wurstmesser  
Couteau à jambon  
Cuchillo para filetear

art.	cm.	col.
18006G20	20	●
18006G25	25	●



**Slicer knife**

Coltello affettare  
Wurstmesser  
Couteau à jambon  
Cuchillo para filetear

art.	cm.	col.
18006R20	20	●
18006R25	25	●
18006R30	30	●



**Slicer knife**

Coltello affettare  
Wurstmesser  
Couteau à jambon  
Cuchillo para filetear

art.	cm.	col.
18006Y20	20	●
18006Y25	25	●
18006Y30	30	●



**Slicer knife, wavy blade**

Coltello affettare, dentato  
Wurstmesser mit Wellenschliff  
Couteau à jambon ondulé  
Cuchillo para filetear, dentado

art.	cm.	col.
18007-25	25	●
18007-30	30	●
18007-36	36	●



**Slicer knife, wavy blade**

Coltello affettare, dentato  
Wurstmesser mit Wellenschliff  
Couteau à jambon ondulé  
Cuchillo para filetear, dentado

art.	cm.	col.
18007G30	30	●



**Cook's knife**

Coltello cucina  
Kochmesser  
Couteau cuisine  
Cuchillo cocina

art.	cm.	col.
18008-20	20	●
18008-26	26	●
18008-30	30	●
18008-36	36	●



**Cook's knife**

Coltello cucina  
Kochmesser  
Couteau cuisine  
Cuchillo cocina

art.	cm.	col.
18008B30	30	●



**Cook's knife**

Coltello cucina  
Kochmesser  
Couteau cuisine  
Cuchillo cocina

art.	cm.	col.
18008R26	26	●
18008R30	30	●
18008R36	36	●



**Cook's knife**

Coltello cucina  
Kochmesser  
Couteau cuisine  
Cuchillo cocina

art.	cm.	col.
18008Y30	30	●



**Ham knife**

Coltello prosciutto  
Schinkenmesser  
Trancheur à rôti  
Cuchillo para jamón

art.	cm.	col.
18009-25	25	●
18009-30	30	●
18009-36	36	●



**Ham knife**

Coltello prosciutto  
Schinkenmesser  
Trancheur à rôti  
Cuchillo para jamón

art.	cm.	col.
18009B25	25	●
18009B30	30	●



**Ham knife**

Coltello prosciutto  
Schinkenmesser  
Trancheur à rôti  
Cuchillo para jamón

art.	cm.	col.
18009G25	25	●
18009G30	30	●



**Ham knife**

Coltello prosciutto  
Schinkenmesser  
Trancheur à rôti  
Cuchillo para jamón

art.	cm.	col.
18009M25	25	●



**Ham knife**

Coltello prosciutto  
Schinkenmesser  
Trancheur à rôti  
Cuchillo para jamón

art.	cm.	col.
18009R25	25	●
18009R30	30	●



**Ham knife**

Coltello prosciutto  
Schinkenmesser  
Trancheur à rôti  
Cuchillo para jamón

art.	cm.	col.
18009W25	25	○
18009W30	30	○



**Ham knife**

Coltello prosciutto  
Schinkenmesser  
Trancheur à rôti  
Cuchillo para jamón

art.	cm.	col.
18009Y25	25	●
18009Y30	30	●



**Salmon knife**

Coltello salmone  
Lachsmesser  
Couteau à saumon  
Cuchillo salmón

art.	cm.	col.
18011-32	32	●



**Ham knife, dimpled ground**

Coltello prosciutto, alveolato  
Schinkenmesser mit Kullenschliff  
Couteau à rôti alvéolé  
Cuchillo jamón con alvéolos

art.	cm.	col.
18010-25	25	●
18010-30	30	●
18010-36	36	●



**Ham knife, dimpled ground**  
Coltello prosciutto, alveolato  
Schinkenmesser mit Kullenschliff  
Couteau à rôti alvéolé  
Cuchillo jamón con alvéolos

art.	cm.	col.
18010Y30	30	●



**Salmon knife, dimpled ground**  
Coltello salmone, alveolato  
Lachsmesser mit Kullenschliff  
Couteau à saumon alvéolé  
Cuchillo salmón con alvéolos

art.	cm.	col.
18012-32	32	●
18012B32	32	●



**Cheese slicer**  
Coltello salati/Formaggio  
Universalmesser  
Couteau universel  
Cuchillo universal/quesos

art.	cm.	col.
18013-30	30	●
18013-36	36	●



**Cheese slicer**  
Coltello salati/Formaggio  
Universalmesser  
Couteau universel  
Cuchillo universal/quesos

art.	cm.	col.
18013G36	36	●

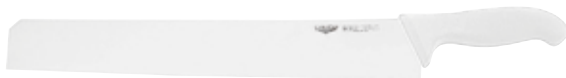

**Cheese slicer**  
Coltello salati/Formaggio  
Universalmesser  
Couteau universel  
Cuchillo universal/quesos

art.	cm.	col.
18013W30	30	○
18013W36	36	○



**Filetting knife**  
Coltello per filettare  
Filiermesser  
Filet de sole  
Cuchillo para filetear

art.	cm.	col.
18015-18	18	●
18015-22	22	●
18015-27	27	●



**Filetting knife**  
Coltello per filettare  
Filiermesser  
Filet de sole  
Cuchillo para filetear

art.	cm.	col.
18015B18	18	●
18015B22	22	●



**Filetting knife**  
Coltello per filettare  
Filiermesser  
Filet de sole  
Cuchillo para filetear

art.	cm.	col.
18015R18	18	●
18015R22	22	●



**Filetting knife**  
Coltello per filettare  
Filiermesser  
Filet de sole  
Cuchillo para filetear

art.	cm.	col.
18015Y18	18	●
18015Y27	27	●



**Boning knife**  
Coltello disosso  
Ausbeinmesser  
Couteau à désosser  
Cuchillo para deshuesar

art.	cm.	col.
18016-14	14	●
18016-16	16	●



**Boning knife**  
Coltello disosso  
Ausbeinmesser  
Couteau à désosser  
Cuchillo para deshuesar

art.	cm.	col.
18016B14	14	●
18016B16	16	●



**Boning knife**  
Coltello disosso  
Ausbeinmesser  
Couteau à désosser  
Cuchillo para deshuesar

art.	cm.	col.
18016R14	14	●
18016R16	16	●



**Boning knife**

Coltello disosso  
Ausbeinmesser  
Couteau à désosser  
Cuchillo para deshuesar

art.	cm.	col.
18016W16	16	○



**Boning knife**

Coltello disosso  
Ausbeinmesser  
Couteau à désosser  
Cuchillo para deshuesar

art.	cm.	col.
18016Y14	14	●
18016Y16	16	●



**Boning knife**

Coltello disosso emilia  
Ausbeinmesser  
Couteau à désosser  
Cuchillo para deshuesar

art.	cm.	col.
18017-14	14	●
18017-16	16	●
18017-18	18	●



**Boning knife**

Coltello disosso emilia  
Ausbeinmesser  
Couteau à désosser  
Cuchillo para deshuesar

art.	cm.	col.
18017B16	16	●
18017R16	16	●
18017Y16	16	●



**Poultry sticking knife**

Coltello scannapoli  
Geflügelschlachtmesser  
Couteau à volaille  
Cuchillo para deshuesar

art.	cm.	col.
18018-11	11	●
18018R11	11	●
18018Y11	11	●



**Sticking knife**

Coltello scannare  
Stechmesser  
Couteau à saigner  
Cuchillo para destrozor

art.	cm.	col.
18019-12	12	●
18019-14	14	●
18019-16	16	●
18019-18	18	●
18019-20	20	●



**Sticking knife**

Coltello scannare  
Stechmesser  
Couteau à saigner  
Cuchillo para destrozor

art.	cm.	col.
18019R12	12	●
18019R16	16	●
18019R18	18	●
18019R20	20	●



**Frozen food, two serrated edges**

Coltello surgelati a doppia lama seghettata  
Tiefkühltruhenmesser, Gezahnter Schliff  
Couteau dentelé pour produits surgelés  
Cuchillo para congelados, hoja doble, dentada

art.	cm.	col.
18020-23	23	●
18020B23	23	●
18020R23	23	●



**Frozen food special serrated blade**

Coltello surgelati lama seghettata speciale  
Tiefkühltruhenmesser, Gezahnter Schliff  
Couteau dentelé pour produits surgelés  
Cuchillo para congelados, dentado especial

art.	cm.	col.
18021-18	18	●
18021B18	18	●
18021R18	18	●



**Steak knife**

Coltello bistecca  
Steakmesser  
Couteau à steak  
Cuchillo para steak

art.	cm.	col.
18022-12	12	●



**Table knife, half-waved**

Coltello tavola, mezzo dentato  
Allzweckmesser  
Couteau universel  
Cuchillo mesa, medio dentado

art.	cm.	col.
18023-11	11	●



**Paring knife**

Spelucchino  
Spickmesser  
Couteau d'office  
Cuchillo mondador

art.	cm.	col.
18024-08	8	●
18024-11	11	●



**Paring knife**

Spelucchino  
Spickmesser  
Couteau d'office  
Cuchillo mondador

art.	cm.	col.
18024G08	8	●
18024G11	11	●



**Paring knife**

Spelucchino  
Spickmesser  
Couteau d'office  
Cuchillo mondador

art.	cm.	col.
18024R08	8	●
18024R11	11	●



**Paring knife**

Spelucchino  
Spickmesser  
Couteau d'office  
Cuchillo mondador

art.	cm.	col.
18024Y08	8	●



**Bent paring knife**

Spelucchino  
Tourniermesser  
Bec d'oiseau  
Cuchillo verdura

art.	cm.	col.
18026G07	7	●
18026M07	7	●



**Steak knife**

Coltello bistecca  
Steakmesser  
Couteau à steak  
Cuchillo para steak

art.	cm.	U. Pack	col.
18217-12	12	6	●



**Paring knife**

Spelucchino  
Spickmesser  
Couteau d'office  
Cuchillo mondador

art.	cm.	col.
18024B08	8	●
18024B11	11	●



**Paring knife**

Spelucchino  
Spickmesser  
Couteau d'office  
Cuchillo mondador

art.	cm.	col.
18024M08	8	●
18024M11	11	●



**Paring knife**

Spelucchino  
Spickmesser  
Couteau d'office  
Cuchillo mondador

art.	cm.	col.
18024W08	8	○
18024W11	11	○



**Bent paring knife**

Spelucchino  
Tourniermesser  
Bec d'oiseau  
Cuchillo verdura

art.	cm.	col.
18026-07	7	●
18026B07	7	●



**Baker's knife**

Coltello pasticceria  
Bäckermesser  
Couteau de pâtissier  
Cuchillo para pastelería

art.	cm.	col.
18029-30	30	●
18029-36	36	●



**Baker's knife**

Coltello pasticceria  
Bäckermesser  
Couteau de pâtissier  
Cuchillo para pastelería

art.	cm.	col.
18029W25	25	○
18029W30	30	○
18029W36	36	○



**Bread knife**

Coltello pane  
Brotmesser  
Couteau à pain  
Cuchillo para pan

art.	cm.	col.
18028-21	21	●



**Bread knife**

Coltello pane  
Brotmesser  
Couteau à pain  
Cuchillo para pan

art.	cm.	col.
18028-25	25	●
18028-30	30	●
18028-36	36	●



**Bread knife**

Coltello pane  
Brotmesser  
Couteau à pain  
Cuchillo para pan

art.	cm.	col.
18028B30	30	●



**Bread knife**

Coltello pane  
Brotmesser  
Couteau à pain  
Cuchillo para pan

art.	cm.	col.
18028M25	25	●



**Bread knife**

Coltello pane  
Brotmesser  
Couteau à pain  
Cuchillo para pan

art.	cm.	col.
18028W21	21	○
18028W25	25	○
18028W30	30	○
18028W36	36	○



**Bread knife**

Coltello pane  
Brotmesser  
Couteau à pain  
Cuchillo para pan

art.	cm.	col.
18028Y25	25	●
18028Y30	30	●



**Universal knife, wavy edge**

Coltello universale, seghettato  
Universalmesser mit Wellenschliff  
Couteau universel, lame dentelée  
Cuchillo universal serrado

art.	cm.	col.
18029-25	25	●



**Cake knife**

Coltello dolce  
Bäckermesser  
Couteau de pâtissier  
Cuchillo para pastelería

art.	cm.	col.
18030-26	26	●
18030-31	31	●
18030-36	36	●



**Cake knife**

Coltello dolce  
Bäckermesser  
Couteau de pâtissier  
Cuchillo para pastelería

art.	cm.	col.
18030W26	26	○
18030W31	31	○
18030W36	36	○





**Slicer, chinese style**

Falcetta cinese  
Kochmesser, chinesische Form  
Couteau de cuisine, style chinois  
Cuchillo cocina, estilo chino

art.	cm.	col.
18221-17	17	●
18221-19	19	●
18221-21	21	●



**Slicer, chinese style**

Falcetta cinese  
Kochmesser, chinesische Form  
Couteau de cuisine, style chinois  
Cuchillo cocina, estilo chino

art.	cm.	col.
18221B17	17	●
18221B19	19	●
18221B21	21	●



**Slicer, chinese style**

Falcetta cinese  
Kochmesser, chinesische Form  
Couteau de cuisine, style chinois  
Cuchillo cocina, estilo chino

art.	cm.	col.
18221G17	17	●
18221G19	19	●
18221G21	21	●



**Slicer, chinese style**

Falcetta cinese  
Kochmesser, chinesische Form  
Couteau de cuisine, style chinois  
Cuchillo cocina, estilo chino

art.	cm.	col.
18221M17	17	●
18221M19	19	●
18221M21	21	●



**Slicer, chinese style**

Falcetta cinese  
Kochmesser, chinesische Form  
Couteau de cuisine, style chinois  
Cuchillo cocina, estilo chino

art.	cm.	col.
18221R17	17	●
18221R19	19	●
18221R21	21	●



**Slicer, chinese style**

Falcetta cinese  
Kochmesser, chinesische Form  
Couteau de cuisine, style chinois  
Cuchillo cocina, estilo chino

art.	cm.	col.
18221Y17	17	●
18221Y19	19	●
18221Y21	21	●



**Meat cleaver**

Falcetta macellaio  
Hackmesser  
Couperet  
Hacha de carnicero

art.	cm.	Kg.	col.
18220-18	18	0,55	●
18220-20	20	1,10	●
18220-22	22	1,30	●
18220-26	26	1,30	●



**Meat cleaver**

Falcetta macellaio  
Hackmesser  
Couperet  
Hacha de carnicero

art.	cm.	Kg.	col.
18220B18	18	0,55	●
18220B20	20	1,10	●
18220B22	22	1,30	●
18220B26	18	0,55	●





**Meat cleaver**  
Falchetta macellaio  
Hackmesser  
Couperet  
Hacha de carnicero

art.	cm.	Kg.	col.
18220R18	20	1,10	●
18220R20	22	1,30	●
18220R22	18	0,55	●
18220R26	20	1,10	●



**Meat cleaver**  
Falchetta macellaio  
Hackmesser  
Couperet  
Hacha de carnicero

art.	cm.	Kg.	col.
18220Y18	22	1,30	●
18220Y20	18	0,55	●
18220Y22	20	1,10	●
18220Y26	22	1,30	●



**Bone splitter**  
Mezzo colpo  
Kochschlagmesser  
Couteau de cuisine lourd  
Cuchillo cocina pesado

art.	cm.	Kg.	col.
18224-28	28	0,75	●
18224B28	28	0,75	●
18224R28	28	0,75	●
18224Y28	28	0,75	●



**Bone splitter**  
Colpo  
Kochschlagmesser  
Couteau de cuisine lourd  
Cuchillo cocina pesado

art.	cm.	Kg.	col.
18225-28	28	1	●
18225R28	28	1	●



**Parmesan knife**  
Grana  
Parmesanmesser  
Couteau à Parmesan  
Cuchillo para queso

art.	cm.	col.
18205-10	10	●



**Parmesan knife**  
Grana  
Parmesanmesser  
Couteau à Parmesan  
Cuchillo para queso

art.	cm.	col.
18205-12	12	●



**Cheese knife**  
Coltello segnaforme  
Käsemesser  
Couteau à fromage  
Cuchillo para queso

art.	cm.	col.
18206-09	9	●



**Cheese knife**  
Coltello lancia "Milano"  
Käsemesser  
Couteau à fromage  
Cuchillo para queso

art.	cm.	col.
18207-15	15	●



**Oyster knife**  
Coltello apriostriche  
Austernmesser  
Couteau à huîtres  
Cuchillo ostras

art.	cm.	col.
18209-06	15	●



**Cheese knife**  
Coltello formaggio  
Käsemesser  
Couteau à fromage  
Cuchillo queso

art.	cm.	col.
18201-36	36	●





**Vegetables knife**

Coltello verdure  
Gemüsemesser  
Couteau à crudités  
Cuchillo verduras

art.	cm.	col.
18222-18	18	●



**Ham boner**

Cannula disosso prosciutti  
Schinkenauslöser  
Gouge à jambons  
Cuchillo deshuesar jamón

art.	cm.	col.
48021-21	21	●



**Cheese knife**

Coltello formaggio  
Käsemesser  
Couteau à fromage  
Cuchillo para queso

art.	cm.	col.
18203-26	26	●



**Baking pan knife**

Coltello gastronomia  
Winkelmesser  
Couteau à gastronomie  
Cuchillo gastronomía

art.	cm.	col.
18215-13	13,5	●



**Baking pan knife**

Coltello gastronomia  
Winkelmesser  
Couteau à gastronomie  
Cuchillo gastronomía

art.	cm.	col.
18215-21	21,5	●



**Farinata knife**

Coltello per farinata  
Farinata Messer  
Couteau à Farinata  
Cuchillo Farinata

art.	cm.	col.
42830-08	8	●



**Pie knife**

Coltello torta  
Tortenmesser  
Couteau à gâteau  
Cuchillo para tartas

art.	cm.	col.
18514-18	18	●



**Mincing knife**

Mezzaluna  
Wiegemesser  
Hachoir  
Media luna

art.	cm.	col.
48017-14	14	●
48017-25	26	●



**Double blade mincing knife**

Mezzaluna, lama doppia  
Wiegemesser, Doppel-Klinge  
Hachoir double lame

Media luna, doble

art.	cm.	col.
48215-14	14	●
48215-30	30	●



**Meat fork**

Forchettone  
Fleischgabel  
Fourchette diapason  
Tenedor para carne

art.	cm.	col.
18226-17	17	●
18226B17	17	●
18226G17	17	●



**Meat fork**

Forchettone  
Fleischgabel  
Fourchette diapason  
Tenedor para carne

art.	cm.	col.
18226R17	17	●
18226W17	17	○
18226Y17	17	●



**Sharpening steel**

Acciaino  
Wetzstahl  
Fusil à affûter  
Afilador

art.	cm.	col.
18235-26	26	●



**Sharpening steel**

Acciaino  
Wetzstahl  
Fusil à affûter  
Afilador

art.	cm.	col.
18235-30	30	●
18235B30	30	●
18235G30	30	●



**Sharpening steel**

Acciaino  
Wetzstahl  
Fusil à affûter  
Afilador

art.	cm.	col.
18235R30	30	●
18235W30	30	○
18235Y30	30	●



**Oval sharpening steel**

Acciaino ovale  
Wetzstahl, oval  
Fusil à affûter, ovale  
Afilador ovalado

art.	cm.	col.
18236-30	30	●



**Diamond sharpening steel**

Acciaino diamantato  
Diamant-Wetzstahl  
Fusil à affûter, diamant  
Afilador adiamantado

art.	cm.	col.
18237-26	26	●



**Sharpening stone GRIT 1000/240**

Pietra per affilare  
Abziehstein  
Pierre à aiguïser  
Piedra para afilar

art.	cm.
18251-01	21x7x3



**Sharpening stone GRIT 1000/600**

Pietra per affilare  
Abziehstein  
Pierre à aiguïser  
Piedra para afilar

art.	cm.
18251-02	21x7x3



**Poultry shears**

Trinciapollo  
Geflügelschere  
Coupe volailles  
Tijeras para ave

art. cm.  
18263-00 25



**Poultry scissors, divisible**

Forbice pollame, smontabile  
Geflügelschere, teilbar  
Ciseaux à volaille, divisible  
Tijeras para aves, desmontables

art. cm.  
18275-00 26,5



**Poultry shears, divisible**

Trinciapollo, smontabile  
Geflügelschere, teilbar  
Coupe volailles, divisible  
Tijeras para aves, desmontables

art. cm.  
18261-00 24



**Seafood scissors**

Forbice per gamberi  
Meeresfrüchteschere  
Ciseaux à crevettes  
Tijeras para camarones

art. cm.  
18278-00 18



**Herb scissors, 5 blades**

Forbice per erbe, 5 lame  
Kräuterschere  
Ciseaux à herbes  
Tijeras hierbas

art. cm.  
18277-00 20



**Salad scissors**

Forbice insalata  
Salatschere  
Ciseaux à salade  
Tijeras para ensalada

art. cm.  
18270-22 22



**Quail egg cutter**

Forbice per uova di quaglia  
Wachteleier-Schere  
Ciseaux oeufs de caille  
Tijeras huevos de codorniz

art. cm.  
18279-14 14





**Kitchen scissors**

Forbice multiuso  
Küchenschere  
Ciseaux cuisine  
Tijeras de cocina, multiuso

art. cm.  
18272-00 18,5



**Divisible kitchen scissors**

Forbice da cucina, smontabile  
Küchenschere, teilbar  
Ciseaux cuisine, divisible  
Tijeras de cocina, desmontables

art. cm.  
18271-00 22,6



**Divisible kitchen scissors**

Forbice da cucina, smontabile  
Küchenschere, teilbar  
Ciseaux cuisine, divisible  
Tijeras de cocina, desmontables

art. cm.  
18273-00 18



**Divisible kitchen scissors**

Forbice da cucina, smontabile  
Küchenschere, teilbar  
Ciseaux cuisine, divisible  
Tijeras de cocina, desmontables

art. cm.  
18274-00 20



**Chinese kitchen scissors**

Forbici cucina cinesi  
Chinesische Küchenschere  
Ciseaux de cuisine chinois

art. cm.  
49636-00 17x8,5

**Stainless steel and brass. – Inox e ottone.**



**Divisible pizza scissors**

Forbice pizza, smontabile  
Pizzaschere, teilbar  
Ciseaux pizza, divisible  
Tijeras para pizza, desmontables

art. cm.  
18276-00 25



# JAPANESE SUSHI KNIVES COLTELLI SUSHI GIAPPONESI

KNIVES  
COLTELLERIA



Excellent choice when preparing sushi and vegetables. Molybdenum/ Vanadium s/s blades for excellent edge retention, razor sharp edges, slip resistant wooden handles. The blades are sharpened with the traditional Japanese single bevel to improve sharpness. The large beveled one-sided edge is much thinner than a two-sided edge. This thinner, sharper edge makes for cleaner cuts through the soft flesh of fish, in particular. Using these knives will avoid bruising the delicate texture of raw fish and destroying the freshness of the fish. The thinner edge is more fragile than the edge on western knives. Do not use for cutting anything solid including larger fish bones. Due to the special blade sharpening and s/s used we highly recommend to only hand wash and dry the blades thoroughly immediately.

Una scelta eccellente per la preparazione di sushi e verdure. Lame in acciaio inox, molibdeno e vanadio, per un'ottimale tenuta del filo, affilatura a rasoio, manici in legno antiscivolo. Secondo la tradizione giapponese l'affilatura è unilaterale ed il filo è molto più sottile rispetto a quello della normale affilatura dei coltelli occidentali. Questo rende i tagli più nitidi ed evita di creare traumi alla trama delicata di carne e pesce crudo. Non utilizzare per il taglio di solidi incluse grosse lisce di pesce. Data la particolarità dell'affilatura e dell'acciaio impiegato si consiglia vivamente di lavare a mano ed asciugare immediatamente con cura le lame.



DEBA

art.	l. cm.
18280-22	22,5
18280-16	16,5
18280-10	10,5

The Deba is a powerful knife used for filleting fish and butchering meat without bones. Its weight and thickness can chop through fish bones and the sharp edge can fillet even the smallest of fish. – Affilato e dalla lama pesante usato per dissosare e tagliare il pesce utilizzato nel sushi. È simile ad un coltello da chef.



OROSHI

art.	l. cm.
18281-24	24

An Oroshi Knife is a Japanese all-purpose cooking knife, but used particularly for fish. – Per sfilettare il tonno e altri pesci di grandi dimensioni.



USUBA

art.	l. cm.
18282-22	22,5
18282-18	18,0
18282-19*	18,0

\*Double bevel. The Usuba is the ultimate vegetable knife. Sharp and thin, it is used by chefs in Japan for katsuramuki, a traditional style of peeling vegetables into thin sheets. – \*Doppia affilatura. Coltello estremamente affilato con una punta quadrata. Questo coltello è usato per tagliare verdure e quando è tenuto ben affilato può tagliarle in fette sottili come un foglio di carta.



TAKO SASHIMI

art.	l. cm.
18283-33	33
18283-27	27

The Tako Sashimi is a variation of the Yanagi and is used to slice straight-cut sashimi. The blunt tip and balanced weight works well on difficult ingredients like octopus, from which it gets its name. Originated in Kanto (Tokyo) region. – Il coltello Tako Sashimi assomiglia di più ad un coltello occidentale ed è utilizzato per affettare tagli spessi di carne per sushi. Ha la lama senza punta, per evitare di rovinare i tentacoli del polpo.



YANAGI SASHIMI

art.	l. cm.
18284-21	21
18284-27	27
18284-30	30
18284-33	33

The Yanagi Sashimi is a slicing knife used to cut boneless fish fillets into sashimi and topping for sushi. The graceful, thin blade cuts beautiful slices in one long, drawing stroke. Originated in Kansai (Osaka) region. – Viene utilizzato per tagliare sottili fette di verdure, carne o pesce, nonché per tagliare in generale a dadi o a fette. Grazie alla sua lama sottile ed affilata è utilizzato anche per creare guarnizioni o tagliare i rotoli di sushi.



**Chef's set, 14 pieces**

Valigia cuoco, 14 pz.  
Kochkoffer, 14 Stk.  
Mallette de chef, 14 pièces  
Maleta del Chef, 14 piezas

art.	des.
18099-15	Comprende/includes:
18000-26	cook's knife/cucina cm 26
18000-30	cook's knife/cucina cm 30
18002-18	butcher's knife/francese cm 18
18002-26	butcher's knife/francese cm 26
18009-30	ham/prosciutto cm 30
18016-16	boning/disosso cm 6
18024-11	paring/spelucchino cm 11
18026-07	paring/spelucchino cm 7
18028-30	bread/pane cm 30
18230-17	fork/forchettone cm 17
18235-30	sharpener/acciaino cm 30
18519-26	spatula/spatola cm 26
48280-34	peeler/pelapatate
18276-00	scissors/forbice pizza

**Chef's set, 17 pcs**

Valigia cuoco, 17 pz.  
Kochkoffer, 17 Stk.,  
Mallette de chef, 17 pcs  
Maleta del Chef, 17 piezas

art.	des.
18199-19	Comprende/includes:
18100-24	cook's knife/cucina cm 24
18100-30	cook's knife/cucina cm 30
18112-30	salmon/salmone cm 30
18115-20	filleting/filettare cm 20
18116-14	boning/disosso cm 14
18125-10	paring/spelucchino cm 10
18126-07	bent paring/spelucchino cm 7
18128-30	bread/pane cm 30
18230-17	fork/forchettone cm 17
18235-30	sharpener/acciaino cm 30
18276-00	scissors/forbice pizza
18255-00	sharpener/affila coltelli
48280-25	apple corer/levatorsoli
48280-34	peeler/pelapatate
48280-02	can opener/apribottiglie
48280-27	melon baller/scavino
48280-92	striper/decora limoni







**Knife roll-bag, 9 pieces forged**

Rotolo portacoltelli, 9 pz. forgiati

Rolltasche, 9-teilig

Rouleau à couteaux, 9 pièces

Bolsa porta cuchillos, 9 piezas

art.	des.
18190-09	Comprende/includes:
18116-14	boning/disosso cm 9
18100-24	cook's/cucina cm 24
18106-25	slicer/affettare cm 25
18109-26	ham/prosciutto cm 24



art.	des.
18124-09	paring/spelucchino
18128-24	bread/pane cm 14
18230-17	fork/forchettone
18235-26	sharpener/acciaino
18271-00	scissors/forbice



**Wood knife block, 9 pcs set**

Ceppo porta coltelli legno, set 9 pz

Holz-Messerblock, 9-tlg.

Bloc à couteaux en bois, set 9 pièces

Bloque portacuchillos de madera, 9 piezas

art.	des.
18192-09	Comprende/includes:
18100-20	cook's/cucina cm 20
18106-20	slicer/affettare cm 20
18124-09	paring/spelucchino cm 9
18128-20	bread/pane cm 20



art.	des.
18230-17	fork/forchettone cm 17
18235-26	sharpener/acciaino cm 26
18271-00	scissors/forbice
18102-16	butcher's/francese cm 16
18126-07	paring/cuoco cm 7



**Knife block, silicone**

Ceppo porta coltelli, silicone

Messerblock, Silikon

Bloc à couteaux, silicone

Bloque portacuchillos, silicona

art.	Ø cm.	h. cm.
18191-22	10,5	22,5





**Magnetic knife rack**

Barra magnetica  
Magnet-Messerhalter  
Porte-couteaux magnetique  
Barra magnética portas cuchillos

art.	cm.
48032-30	30
48032-45	45
48032-60	60



SS

**E**dlund

**Knife block**

Ceppo porta coltelli  
Messerblock  
Bloc à couteaux  
Bloque portacuchillos

art.	cm.
49875-06	26x14x33



SS

**E**dlund

**Knife rack**

Porta coltelli  
Messeraufhänger  
Support à couteaux  
Porta cuchillos

art.	cm.
48040-00	30,5x6,6x30,5
48040-AA	

**Holds 8 chef 's knives, 2 smaller knives, 1 steel and scissors.** – Per 8 coltelli cuoco, 2 coltelli piccoli, 1 acciaio e forbici.



SS

**E**dlund

**Knife rack**

Porta coltelli  
Messeraufhänger  
Support à couteaux  
Porta cuchillos

art.	cm.
48040-10	30,5x6,6x35,6
48040-AA	

**Holds 8 chef 's knives, 2 smaller knives, 1 steel and scissors.** – Per 8 coltelli cuoco, 2 coltelli piccoli, 1 acciaio e forbici.



SS

**E**dlund

**Knife rack**

Porta coltelli  
Messeraufhänger  
Support à couteaux  
Porta cuchillos

art.	cm.
48039-06	15,2x6,6x30,5

**Holds 1 cleaver and 4 chef knives or 6 chef knives or 8 slicers or 12 paring knives and 1 round or diamond steel.** – Per 1 mannaia e 4 coltelli cuoco o 6 coltelli cuoco o 8 coltelli affettare o 12 spelucchini e 1 acciaio tondo.



SS

**E**dlund

**Knife sanitizing system**

Sterilizzatore ad immersione  
Messerentkeimer  
Stérilisateur à couteaux  
Esterilizador a inmersión

art.	cm.
48040-50	45,7x11,5x45,7



**Manual sharpener**

Affilacoltelli manuale  
Messer Schleifapparat  
Affûteur manuel  
Afilador manual

art.
18255-00



**Manual sharpener**

Affilacoltelli manuale  
Messer Schleifapparat  
Affûteur manuel  
Afilador manual

art.
49739-00



**Salami pricker**

Pungisalame  
Salamistachel  
Pique saucisson  
Picadura pra embutido

art.
42523-00



SS

**Larding needle, with flap**

Ago lardellare, con becco  
Spicknadel, mit Klappe  
Lardoire à clapet  
Aguja con clip

art.	Ø mm.	cm.
42514-20	5	20



SS

**Lacing needle, straight**

Ago da cucina  
Dressiernadel, gerade  
Aiguille à brider, droite  
Aguja de cocina

art.	cm.
42515-18	18
42515-20	20



SS

**Lacing needle, bent**

Ago da cucina, curvo  
Dressiernadel, gebogen  
Aiguille à brider, courbe  
Aguja de cocina

art.	cm.
42516-18	18
42516-20	20



SS

**Needles 5 pcs set**

Aghi set 5 pz  
Nadelsatz, 5 Stk.  
Aiguilles set 5 pcs  
Agujas 5 pz

art.
42517-06



W

**Skewers, 100 pcs**

Spiedini, 100 pz  
Fleischspieße, 100 Stk  
Brochettes, 100 pcs  
Palos para asar, 100 pz

art.	cm.
48307-01	15
48307-02	20
48307-03	25



SS

**Skewers 6 pcs set**

Spiedini set 6 pz  
Fleischspieße, Satz 6 Stk  
Brochettes set 6 pcs  
Palos para asar 6 pz

art.	cm.
42529-06	30



**Skewers flat, 18/8**

Spiedini piatti, 18/8  
Fleischspieße, flach, 18/8  
Brochettes plates, 18/8  
Pinchos planos, 18/8

art.	mm.	U. Pack
42511-20	200x3	10
42511-25	250x3	10
42511-30	300x3	10
42511-35	350x3	10
42511-40	400x3	10
42511-56	560x5	10



**Swords, 18/8**

Spade, 18/8  
Schwerter, 18/8  
Epées, 18/8  
Espadas, 18/8

art.	mm.
42511-60	600x15x3
42511-70	700x15x3



SS

**Anchor meat hook**

Gancio ad ancora  
Anker Fleischhaken  
Esse à ancre  
Gancho forma ancla

art.	Ø mm.	cm.	U. Pack
42507-12	7	13	10



SS

**Sliving meat hook**

Gancio girevole  
Fleischdrehhaken  
Esse-tournante  
Gancho giratorio

art.	Ø mm.	cm.	U. Pack
42525-27	12	27	10



SS

**Meat hook, 2 peacks**

Gancio fisso, 2 punte  
Fleischhaken, 2 Spitze  
Crochet esse, 2 pointes  
Gancho 2 puntas

art.	Ø mm.	cm.	U. Pack
42524-06	3	6	10
42524-08	4	8	10
42524-10	4	10	10
42524-12	5	12	10
42524-14	5	14	10
42524-16	6	16	10
42524-18	6	18	10
42524-20	9	20	10
42524-22	9	22	10
42524-30	12	30	10



SS

**Meat hook, 1 peack**

Gancio fisso, 1 punta  
Fleischhaken, 1 Spitze  
Crochet esse, 1 pointe  
Gancho 1 punta

art.	Ø mm.	cm.	U. Pack
42506-08	3	8	10
42506-10	4	10	10
42506-12	5	12	10
42506-14	5	14	10
42506-16	6	16	10
42506-18	6	18	10



SS

**Swivel meat hook**

Gancio girevole  
Fleischdrehhaken  
Esse-tournante  
Gancho giratorio

art.	Ø mm.	cm.
42505-21	9	22
42505-24	10	26
42505-27	12	28
42505-50	12	50



SS

**Sliding meat hook**

Gancio scorrevole  
Fleischhaken  
Crochet coulissant  
Gancho

art.	Ø mm.	cm.	U. Pack
42526-12	9	12	10
42526-14	12	14	10



SS

**Ham-tong**

Pinza per affettati  
Schinkenzange  
Pince à jambon  
Pinza para jamón

art.	cm.
42510-00	11x6



SS

**Meat tenderizer**

Batticarne a pugno  
Kotelettklopfer  
Aplatisseur  
Aplasta carnes

art.	Kg.
42501-15	1,5
42501-20	2,0



SS

**Meat tenderizer**

Batticarne a due tagli  
Kotelettklopfer  
Aplatisseur  
Aplasta carnes

art.	Kg.
42502-11	1,1



SS

**Meat tenderizer**

Batticarne a paletta  
Kotelettklopfer  
Aplatisseur  
Aplasta carnes

art.	Kg.
42503-10	1

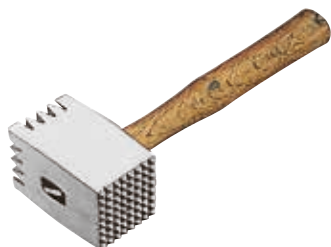

**Steak hammer, aluminum**

Batticarne, alluminio  
Aluminum-Fleischklopfen  
Attendrisseur, alu  
Aplasta carnes, aluminio

art.	cm.	Kg.
42508-00	32	0,6



**Steak hammer, aluminum**

Batticarne, alluminio  
Aluminum-Fleischklopfen  
Attendrisseur, alu  
Aplasta carnes, aluminio

art.	cm.	Kg.
42508-01	25	0,41



SS

**Bone-saw**

Sega per ossa  
Knochensäge  
Scie à os  
Sierra de cocina

art.	cm.
48231-40	40
48231-45	45
48231-50	50



SS

**String holder**

Portaspago  
Schnurrolle-Halter  
Porte rolls sur socle  
Porta cuerda

art.	cm.
42579-00	19x12x17



SS

**Meat pan**

Vassoio rettangolare  
Fleischblech  
Plat boucher  
Bandeja rectangular

art.	cm.
42534-26	26x23x2
42534-32	34x21x2
42534-41	45x25x2



SS

**Display tray**

Vassoio espositore  
Ausstellplatte  
Plateau  
Bandeja expositora

art.	cm.
42532-29	29x21x2
42532-58	58x21x2



SS

**Meat pan**

Vassoio  
Fleischblech  
Plat boucher  
Contenedor

art.	cm.
42530-26	24,4x21,6x5,5
42530-32	32x23x5,5
42530-41	41x31x5,5
42530-50	50x35x5,5



SS

**Meat pan with grid**

Vassoio con griglia  
Fleischblech mit Siebeinsatz  
Plat boucher avec grille  
Contenedor con rejilla

art.	cm.
42531-26	24,4x21,6x5,5
42531-32	32x23x5,5
42531-41	41x31x5,5
42531-50	50x35x5,5



**Ham stand on wood**

Ferma prosciutto base legno  
Schinkenhalter, Holzsockel  
Pince à jambon sur bois  
Jamonero, base madera

art.	cm.	Kg.
41582-00	24x45x16	4,5

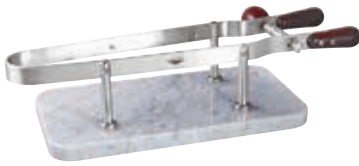

**Ham stand on marble**

Ferma prosciutto base marmo  
Schinkenhalter, Marmorsockel  
Pince à jambon sur marbre  
Jamonero, base mármol

art.	cm.	Kg.
41583-00	24x45x15	10,3



SS

**Hamburger press**

Pressa-hamburger  
Hamburgerpresse  
Moule à steak  
Prensa para hamburguesa

art.	Ø cm.	l. cm.
42864-10	10	36



**Hamburger press, anodized aluminum**

Pressa-hamburger, alluminio anodizzato  
Hamburgerpresse, Aluminium eloxiert  
Moule à steak, aluminium anodisé  
Prensa para hamburguesa, aluminio anodizado

art.	cm.	Kg.
49978-10	37x25x50	5,0
49978-13	42x27,5x53	5,5

**The parts coming into contact with food are in stainless steel. – Parti a contatto con il cibo in acciaio inox per alimenti.**



**Vertical manual sausage filler**

Insaccatrice verticale  
Wurstfüller  
Poussoir manuel vertical  
Ensacadora vertical

art.	cm.	lt.	Kg.
49876-03	30x22x47,5	3	6,2

**With 3 funnels. – Con 3 imbuti.**



**Slicer**

Affettatrice  
Aufschnitt-Maschine  
Trancheur  
Cortadora

art.	Ø cm.	cm.	Kg.
49971-25	25	68x52x51	33

**Cut thickness range mm 0÷2,3. 9 cutting positions. Cut cm 18,5x51. – Spessore taglio mm. 0÷2,3. 8 scatti. Taglio utile cm 18,5x15.**



**Slicer**

Affettatrice  
Aufschnitt-Maschine  
Trancheur  
Cortadora

art.	Ø cm.	cm.	Kg.
49972-30	30	72x60x74	45,5

**Cut thickness range mm 0÷2,5. 9 cutting positions. Cut cm 23x19. – Spessore taglio mm. 0÷2,5. 9 scatti. Taglio utile cm 23x19.**



**Slicer**

Affettatrice  
Aufschnitt-Maschine  
Trancheur  
Cortadora

art.	Ø cm.	des.
49971R25	25	Rose
49971M25	25	Daisy
49972R30	30	Rose
49972M30	30	Daisy



**Stand**

Piedistallo  
Sockel  
Piédestal  
Pedestal

art.	cm.
49971P25	65x80
49972P30	65x80



**Stand with wheels**

Piedistallo con ruote  
Sockel mit Rädern  
Piédestal avec roues  
Pedestal con ruedas

art.	cm.
49971R00	65x80



**Block brush, plastic handle**  
Spazzola per ceppa  
Blockbürste, Kunststoffgriff  
Brosse à billot, matière plastique  
Cepillo para cepa

art.	cm.
42518-01	20



PE

**Cutting board with tray**  
Tagliere con vasca  
Tranchierbrett mit Tablett  
Planche à découper avec plateau  
Tabla de corte con bandeja

art.	cm.
44947-00	33,5x46x5,5



HDPE

**Cutting board**  
Tagliere bar  
Tranchierbrett  
Planche à découper  
Tabla de corte

art.	cm.
42521-16	16x24,5x1
42521-24	24,5x32,5x1



03 = RED / ROSSO  
Raw meat and poultry  
Carni crude  
Rohes Fleisch  
Viande crue  
Carne cruda



02 = BROWN / MARRONE  
Raw vegetables  
Verdure crude  
Rohes Gemüse  
Crudités  
Verduras crudas



04 = BLUE / BLU  
Raw fish  
Pesce  
Fisch  
Poisson  
Pescado



01 = YELLOW / GIALLO  
Cooked meats  
Carni cotte  
Gekochtes Fleisch  
Viande cuite  
Carne cocida



05 = GREEN / VERDE  
Salads and fruits  
Insalata e frutta  
Salat und Früchte  
Salade et fruits  
Ensalada y fruta



00 = WHITE / BIANCO  
Bakery and dairy products  
Pane e formaggi  
Brot und Käse  
Pain et fromages  
Pan y quesos



07 = VIOLA / VIOLET  
Gluten Free  
Casher  
Halal  
Vegan



HDPE

**Cutting board**  
Tagliere bar  
Tranchierbrett  
Planche à découper  
Tabla de corte

art.	cm.	GN	col.
42522-00	32x26,5x2	1/2	○
42522-01	32x26,5x2	1/2	●
42522-02	32x26,5x2	1/2	●
42522-03	32x26,5x2	1/2	●
42522-04	32x26,5x2	1/2	●
42522-05	32x26,5x2	1/2	●
42522-09	32x26,5x2	1/2	●



HDPE

**Cutting board**  
Tagliere bar  
Tranchierbrett  
Planche à découper  
Tabla de corte

art.	cm.	GN	col.
42538-00	53x32,5x2	1/1	○
42538-01	53x32,5x2	1/1	●
42538-02	53x32,5x2	1/1	●
42538-03	53x32,5x2	1/1	●
42538-04	53x32,5x2	1/1	●
42538-05	53x32,5x2	1/1	●
42538-09	53x32,5x2	1/1	●

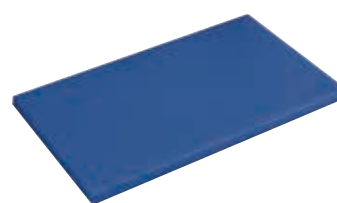

HDPE

**Cutting board**  
Tagliere bar  
Tranchierbrett  
Planche à découper  
Tabla de corte

art.	cm.	col.
42539-00	60x40x2	○
42539-01	60x40x2	●
42539-02	60x40x2	●
42539-03	60x40x2	●
42539-04	60x40x2	●
42539-05	60x40x2	●
42539-09	60x40x2	●



HDPE

**Cutting board**  
Tagliere bar  
Tranchierbrett  
Planche à découper  
Tabla de corte

art.	cm.
42522-07	32x26,5x2
42538-07	53x32,5x2
42539-07	60x40x2



HDPE

**Cutting board**  
Tagliere bar  
Tranchierbrett  
Planche à découper  
Tabla de corte

art.	cm.
42537-40	40x30x2
42537-50	50x30x2
42537-80	80x40x2



HDPE

**Cutting board with groove**  
Tagliere con canalina  
Tranchierbrett mit Kanal  
Planche à découper avec rigole  
Tabla de corte con ranura

art.	cm.	GN	col.
42546-00	65x53x2	2/1	○
42546-01	65x53x2	2/1	●
42546-02	65x53x2	2/1	●
42546-03	65x53x2	2/1	●
42546-04	65x53x2	2/1	●
42546-05	65x53x2	2/1	●



HDPE

**Cutting board with stoppers**

Tagliere con fermi  
Tranchierbrett mit Stiften  
Planche à découper avec arrêts  
Tabla de corte con barras de la parada

art.	cm.	GN	col.
42543-00	53x32,5x2	1/1	○
42543-01	53x32,5x2	1/1	●
42543-02	53x32,5x2	1/1	●
42543-03	53x32,5x2	1/1	●
42543-04	53x32,5x2	1/1	●
42543-05	53x32,5x2	1/1	●



HDPE

**Cutting board with stoppers**

Tagliere con fermi  
Tranchierbrett mit Stiften  
Planche à découper avec arrêts  
Tabla de corte con barras de la parada

art.	cm.	col.
42544-00	60x40x2	○
42544-01	60x40x2	●
42544-02	60x40x2	●
42544-03	60x40x2	●
42544-04	60x40x2	●
42544-05	60x40x2	●



HDPE

**Cutting board with stoppers**

Tagliere con fermi  
Tranchierbrett mit Stiften  
Planche à découper avec arrêts  
Tabla de corte con barras de la parada

art.	cm.
42540-40	40x30x2
42540-50	50x30x2
42540-80	80x40x2



HDPE

**Colored cutting boards set 6 pcs**

Taglieri colorati set 6 pz  
Tranchierbretter 6 Stk.  
Planches à découper set 6 pcs  
Juego 6 tablas de corte

art.	cm.
42541-06	46x31x1,3



HDPE

**Round cutting board**

Tagliere tondo  
Tranchierbrett, rund  
Planche à découper, ronde  
Tabla de corte redonda

art.	Ø cm.	h. cm.
42535-24	24,0	1,0
42535-32	32,5	1,5
42535-49	49,0	1,5



HDPE

**Butchers table**

Ceppa  
Hackblock  
Billot  
Cepa

art.	cm.	mm.
42518-50	50x50x86	4*

\*Thickness. – Spessore.





HDPE

**Worktop**

Ceppo  
Arbeitsplatte  
Plan de travail  
Encimera

art. cm. mm.  
42519-01 50x50 4\*

\*Thickness. – Spessore.



HDPE

**Board scraper**

Raschietto  
Raschietto  
Blockschäber  
Racloir à planches  
Rascador

art. cm.  
42520-00 17x6x9

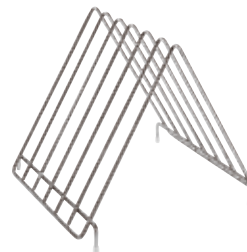

SS

**Cutting board rack**

Portataglieri in filo  
Tranchierbretter-Träger  
Sechoir à plaques à découper  
Porta tablas

art. cm.  
42542-00 30x26x27,5



W

**Bread cutting board**

Tagliere pane  
Brotschneidbrett  
Planche à découper  
Tabla de corte

art. cm.  
42964-53 53x32,5x2  
42964-60 60x40x2



CE

SS

**Chainmail glove**

Guanto in cotta di maglia  
Fingerhandschuhe  
Gant en cotte de mailles  
Guante de malla

art. size/T. col.  
48505-01 Small ○  
48505-02 Medium ●  
48505-03 Large ●

**UNI EN 1082-1:1998. Fits either hands, rings ø 4 mm. Thickness ø 0,5 mm. nylon strap.**  
Ambidestro, anelli ø 4 mm. Spessore ø 0,5 mm. cinturino nylon.



CE

SS

**Chainmail glove, extended cuff**

Guanto lungo in cotta di maglia  
Fingerhandschuhe, lang  
Gant en cotte de mailles, manchette longue  
Guante largo de malla

art. size/T. col.  
48506-01 Small ○  
48506-02 Medium ●  
48506-03 Large ●

**UNI EN 1082-1:1998. Fits either hands, rings ø 4 mm. Thickness ø 0,5 mm. nylon strap.**  
Ambidestro, anelli ø 4 mm. Spessore ø 0,5 mm. cinturino nylon.



CE

SS

**Protective apron**

Grembiule di protezione  
Schutzschürze  
Tablier de protection  
Delantal de protección

art. cm.  
48501-76 75x55

**UNI EN 1082-1:1998. Belt fastening with textile adjustable and detachable straps. – Dotato di bretelle regolabili e staccabili.**



**Oven mitt**

Guanto da forno  
Ofenhandschuh  
Moufle de déformement  
Manopla de protección

art. l. cm.  
48510-00 28

**Outer fabric 100% cotton with silver coating, 100 g/mq. – Tessuto esterno 100% cotone con rivestimento argenteo 100 g/mq.**



**Oven mitt, silicone**

Guanto da forno, silicone  
Backhandschuhe, Silikon  
Gant de protection, silicone  
Manopla de protección, silicona

art.  
48514-00

**Ambidextrous. Contact heat resistant up to +300°C for 15 seconds. Non-slip, water and oil tight, dishwasher safe. – Ambidestro. Resistenza al calore per contatto fino a 300°C per 15 secondi. Stagno all'acqua e agli oli bollenti, lavabile in lavastoviglie.**



**Cut resistant glove**

Guanto anti taglio  
Schnittschutz-Handschuh  
Gant anti-coupures  
Guante de protección

art.	size/T.
48523-01	S
48523-02	M
48523-03	L
48523-04	XL

**Spectra fiber glove, cut resistance std EN388: level 5, washable up to 90°C, ambidextrous. Supplied with cotton underglove.** – Guanto in fibra spectra, resistenza al taglio std EN388: livello 5, lavabile fino a 90°C, ambidestro. Fornito con sottoguanto in cotone.



**Three-finger oven glove**

Guanti anticalore a 3 dita  
Backhandschuhe, 3 Finger  
Moufles protection thermique, 3 doigts  
Guantes de protección

art.	l. cm.
48517-03	35,5

**Resistant to abrasion, tears and cuts. CE marking, in accordance to the basic requirements concerning health and security of the European Directives 89/686/C.E.E. Contact heat resistant up to +350°C for 20 seconds.**  
Resistenti all'abrasione, agli strappi ed ai tagli. Marcati CE, rispettano i requisiti essenziali di salute e sicurezza secondo le direttive europee 89/686/C.E.E. Hanno una resistenza al calore per contatto fino a 350°C per 20 secondi.



**Oven mitts**

Guanti da forno  
Backhandschuhe  
Moufles de défournement  
Manoplas de protección

art.	cm.
48511-02	34x16

**Special cotton fabric, natural color, reinforced palm and thumb. Heat resistant up to +200°C. Machine washable up to +40°C.**  
In cotone speciale, colore naturale, esecuzione rinforzata palmo e pollice. Resistente fino a +200°C. Lavabile in lavatrice max. 40°C.



**Oven mitts**

Guanti da forno  
Backhandschuhe  
Moufles de défournement  
Manoplas de protección

art.	cm.
48513-02	26x14,5

**Special cotton fabric, natural color, reinforced palm and thumb. Heat resistant up to +200°C. Machine washable up to +40°C.**  
In cotone speciale, colore naturale, esecuzione rinforzata palmo e pollice. Resistente fino a +200°C. Lavabile in lavatrice max. 40°C.



**Oven mitts**

Guanti da forno  
Backhandschuhe  
Moufles de défournement  
Manoplas de protección

art.	cm.
48512-02	27x15

**Special cotton fabric, natural color, reinforced palm and thumb. Heat resistant up to +200°C. Machine washable up to +40°C.**  
In cotone speciale, colore naturale, esecuzione rinforzata palmo e pollice. Resistente fino a +200°C. Lavabile in lavatrice max. 40°C.



**Oven glove, nitrile**

Guanti anticalore, nitrile  
Backhandschuhe, Nitril  
Moufles protection thermique, nitrile  
Guantes de protección, nitrile

art.	l. cm.	size/T.
48515-09	45	9
48515-11	45	11
48515-12	45	12

**Contact heat protection up to 150°C. Resistance to oils, grases and main detergents. Washable inside and outside.**  
Protezione al calore da contatto fino a 150°C. Resistenza agli oli, ai grassi e ai principali detersivi. Lavabili all'interno e all'esterno.



**Scrubbing gloves**

Guanti scrub  
Schrubben Handschuhe  
Gants à scrubbing  
Guantes para fregar

art.	size/T.
48518-01	one size



**Scrubbing gloves**

Guanti scrub  
Schrubben Handschuhe  
Gants à scrubbing  
Guantes para fregar

art.	size/T.
48518-02	one size



**Sugar gloves**

Guanti in lattice  
Zucker-Handschuhe  
Gants à tirer le sucre  
Guantes de látex

art.	size/T.
48516-07	7 – 7 1/2
48516-08	8 – 8 1/2
48516-09	9 – 9 1/2



**Gloves, nitrile**

Guanti nitrile  
Handschuhe, Nitril  
Gants en nitrile  
Guantes de nitrilo

art.	pcs/pz	size/T.
48519-01	100	S
48519-02	100	M
48519-03	100	L
48519-04	100	XL

**Treatment Powder free. Latex-free. Finish microgrip.** – Trattamento Powder free. Latex free. Finitura Microgrip.



HDPE

**Gloves**

Guanti  
Handschuhe  
Gants  
Guantes

art.	l. cm.	pcs/pz	size/T.
48522-24	24	500	one size

**Palm and fingers microgrip finishing.**  
Finitura palmo e dita microgrip.



**Paper Chef hat**

Cappello Grand Chef, carta  
Kochmütze, Papier  
Toque papier  
Tocado, papel

art.	h. cm.	pcs/pz
48520-20	20	20
48520-23	23	20
48520-30	30	20

**Double crepe paper processing, absorbent, adjustable size, ventilated.** – Carta crespata doppia lavorazione, fascia assorbi sudore, adesivo regolabile, areato.



**Apron, LDPE**

Grembiule LDPE  
Schurz, LDPE  
Tablier, LDPE  
Delantal, LDPE

art.	cm.	pcs/pz
48524-75	75x120	50

**Waterproof and resistant, length 120 cm from the chest, total length 140 cm.**  
Impermeabile e resistente, lunghezza 120 cm dal petto, totale 140 cm.



**Chef's hat, TNT**

Cappello Monsieur Chef, TNT  
Chef-Kochmütze, tnt  
Toque plissée chef, TNT  
Gorro Chef, TNT

art.	pcs/pz
48529-00	20

**Tnt-polypropylene, pleated, band absorb sweat, adjustable adhesive to fix the size.**  
Tnt-polipropilene, plissettato, fascia assorbi sudore, adesivo regolabile per fissare la taglia.



**Paper cap**

Bustina carta  
Papier Mütze  
Calot papier  
Gorro barco papel

art.	pcs/pz
48528-00	100

**Double paper processing, absorbent, adjustable size, ventilated.** – Carta doppia lavorazione, fascia assorbi sudore, adesivo regolabile, aerata.



**Cap, TNT**

Cuffia, TNT  
Einweghauben, TNT  
Charlotte, TNT  
Cubrecabezas, TNT

art.	pcs/pz
48527-00	100

**Pleated cap, TNT 16gr/m2, very light, soft elastic, ø 50 cm.** – Cuffia plissettata TNT 16gr/m2, molto leggera, morbido elastico, ø 50 cm.



**Visitor kit, TNT**

Kit visitatore, TNT  
Besucher-Kits, TNT  
Kit visiteur, TNT  
Conjunto visitador, TNT

art.	pcs/pz
48525-03	1

**1 TNT overall and cap, 1 CPE overshoes.**  
1 camice e cuffia in TNT e 1 set copriscarpe CPE.



PE

**Overshoes**

Copriscarpe  
Überschuhe  
Sur-chaussures  
Cubrezapatos

art.	l. cm.	pcs/pz
48526-44	44	110

**PE double-thickness, waterproof, elastic ankle, embossed bottom.** – PE doppio spessore, impermeabili, elastico alla caviglia, fondo gofrato.

# PASTRY PASTICCERIA

EQUIPMENT  
ATTREZZATURE





**Alphabet pcs 26**

Alfabeto pz 26

art. Ø cm. h. cm.

47301-12 12 2



**Numbers pcs 10**

Numeri pz 10

art. Ø cm. h. cm.

47302-10 10 2

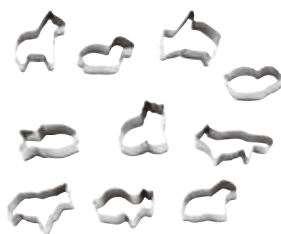

**Animals pcs 10**

Animali pz 10

art. Ø cm. h. cm.

47303-10 10 2

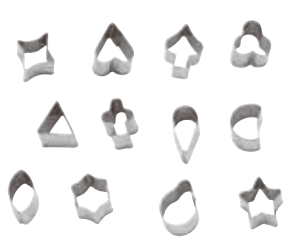

**Shapes pcs 12**

Sagome pz 12

art. Ø cm. h. cm.

47304-06 6,5 2

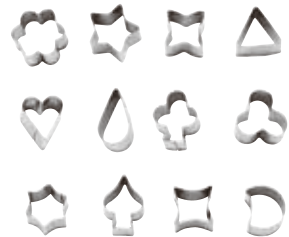

**Shapes pcs 12**

Sagome pz 12

art. Ø cm. h. cm.

47304-10 10 2



**Shapes pcs 12**

Sagome pz 12

art. Ø cm. h. cm.

47304-12 12 2



**Shapes pcs 12**

Sagome pz 12

art. Ø cm. h. cm.

47305-12 12 2



**Flower pcs 6**

Fiore pz 6

art. Ø cm. h. cm.

47306-10 10 3

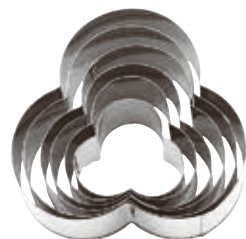

**Trio pcs 6**

Trio pz 6

art. Ø cm. h. cm.

47307-10 10 3



**Heart pcs 6**

Cuore pz 6

art. Ø cm. h. cm.

47308-10 10 3



**Star pcs 6**

Stella pz 6

art. Ø cm. h. cm.

47310-10 10 3



**Halfmoon pcs 6**

Mezzaluna pz 6

art. Ø cm. h. cm.

47312-10 10 3

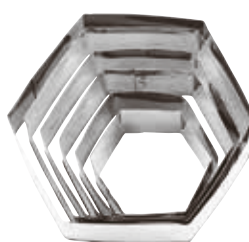

**Hexagon pcs 6**

Esagono pz 6

art. Ø cm. h. cm.

47314-10 10 3

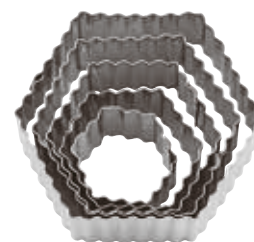

**Hexagon, fluted pcs 5**

Esagono festonato pz 5

art. Ø cm. h. cm.

47315-10 10 3,5



**Ring pcs 11**

Anello pz 11

art. Ø cm. h. cm.

47316-10 10 3



**Ring pcs 14**

Anello pz 14

art. Ø cm. h. cm.

47316-12 12 3



**Ring pcs 20**

Anello pz 20

art. Ø cm. h. cm.

47316-20 20 2,5



**Ring, fluted pcs 11**

Anello festonato pz 11

art. Ø cm. h. cm.

47317-10 10 3





**Ring, fluted pcs 14**

Anello festonato pz 14

art.      Ø cm.    h. cm.  
47317-12    12      3



**Ring, fluted pcs 20**

Anello festonato pz 20

art.      Ø cm.    h. cm.  
47317-20    20      2,5



**Drop pcs 6**

Goccia pz 6

art.      Ø cm.    h. cm.  
47321-12    12      3

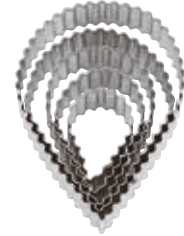

**Drop, fluted pcs 5**

Goccia festonata pz 5

art.      Ø cm.    h. cm.  
47322-12    12,5    3,5



**Square pcs 6**

Quadro pz 6

art.      Ø cm.    h. cm.  
47323-12    12      3



**Square, fluted pcs 6**

Quadro festonato pz 6

art.      Ø cm.    h. cm.  
47324-12    12,5    3,5



**Oval pcs 9**

Ovale pz 9

art.      Ø cm.    h. cm.  
47326-10    10      3,5

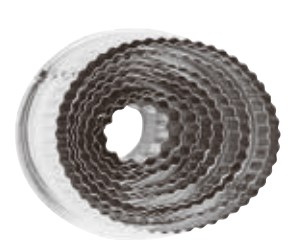

**Oval, fluted pcs 9**

Ovale festonato pz 9

art.      Ø cm.    h. cm.  
47325-10    10      3,5



**Fruit pcs 12**

Frutta pz 12

art.      Ø cm.    h. cm.  
47327-12    12,5    2



**Animals pcs 10**

Animali pz 10

art.      Ø cm.    h. cm.  
47328-15    15      2



**Vehicles pcs 7**

Veicoli pz 7

art.      Ø cm.    h. cm.  
47331-15    15      2



**Vegetable pcs 12**

Verdura pz 12

art.      Ø cm.    h. cm.  
47332-12    12,5    2



**Christmas pcs 7**

Natale pz 7

art.      Ø cm.    h. cm.  
47333-15    15      2



**Easter pcs 6**

Pasqua pz 6

art.      Ø cm.    h. cm.  
47334-12    12,5    2

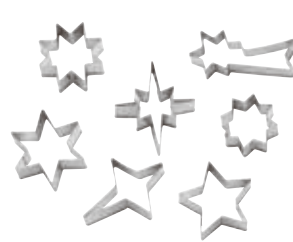

**Stars pcs 7**

Stelle pz 7

art.      Ø cm.    h. cm.  
47335-12    12,5    2



**Shapes pcs 10**

Sagome pz 10

art.      Ø cm.    h. cm.  
47419-10    20      3,5



**Shapes pcs 42**

Sagome pz 42

art.      Ø cm.  
47336-42    6>22



**Plain ring pcs 3**

Anello liscio pz 3

art.      Ø cm.    h. cm.  
47414-03    6-7-8    3



**Fluted ring pcs 3**

Anello festonato pz 3

art.      Ø cm.    h. cm.  
47415-03    6-7-8    3



**Canestrello**

Canestrello

art.      Ø cm.    h. cm.  
47416-06    6      3



**Canestrello, fluted**  
Canestrello festonato

art.            Ø cm.    h. cm.  
47417-06    6            3



**Wheel**  
Ruota

art.  
47418-00



**CHRISTMAS**  
NATALE



**Gingerbread man**  
Omino pan di zenzero

art.            cm.  
47370-08    6x8x3



**Angel**  
Angelo

art.            cm.  
47377-08    7x7x3



**Snowman**  
Pupazzo di neve

art.            cm.  
47378-08    4x8x3



**Reindeer**  
Renna

art.            cm.  
47379-08    8x7x3



**Star**  
Stella

art.            cm.  
47411-08    8x8x3

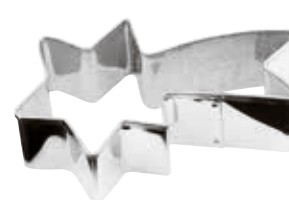

**Comet**  
Stella cometa

art.            cm.  
47412-08    8x4x3



**Christmas tree**

Albero di Natale

art. cm.  
47413-08 8x8x3



**Pine**

Pino

art. cm.  
47413-01 6,4x8x3



**Snowflake**

Fiocco di neve

art. cm.  
47411-01 7,4x8,6x3



**Snowflake**

Fiocco di neve

art. cm.  
47411-02 7x8x3



**Snowflake**

Fiocco di neve

art. cm.  
47411-03 8,5x8x3



**Christmas, set of 6 pcs.**

Natale set 6 pz

art. cm.  
47387-01 8x8x3



**EASTER  
PASQUA**



**Rabbit  
Coniglio**

art. cm.  
47372-08 8x4x3



**Rabbit  
Coniglio**

art. cm.  
47402-08 8x5x3



**Rabbit  
Coniglio**

art. cm.  
47402-01 7x8,5x3







**Rabbit**  
Coniglio  
art. cm.  
47402-02 7,5x7x3



**Bell**  
Campana  
art. cm.  
47373-08 6x7x3



**Lamb**  
Agnellino  
art. cm.  
47376-08 8x7x3



**Dove**  
Colomba  
art. cm.  
47382-08 8x7x3



**Egg**  
Uovo  
art. cm.  
47373-01 5,6x8x3

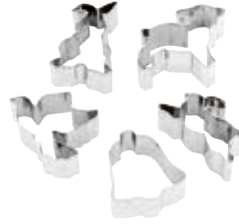

**Easter, set of 5 pcs.**  
Pasqua set 5 pz  
art. cm.  
47387-02 8x8x3



## HALLOWEEN



**Skeleton**  
Scheletro  
art. cm.  
47370-08 6x8x3

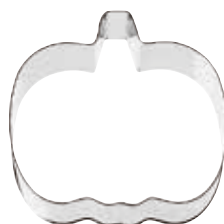

**Pumpkin**  
Zucca  
art. cm.  
47377-09 9x8x3



**Pumpkin**  
Zucca  
art. cm.  
47377-10 8x8x3



**Crescent**

Mezzaluna

art. cm.  
47377-01 6,2x8x3



**Owl**

Gufo

art. cm.  
47377-02 4,7x8,3x3



**Ghost**

Fantasma

art. cm.  
47377-03 8x8,4x3



**Witch**

Strega

art. cm.  
47377-04 9x9,5x3



**Witch hat**

Cappello strega

art. cm.  
47377-05 8,5x13x3



**Witch on broom**

Strega su scopa

art. cm.  
47377-06 11,6x12x3



**Skull**

Teschio

art. cm.  
47377-07 8x8x3



**Halloween, set of 3 pcs.**

Halloween set 3 pz

art. cm.  
47377-11 11x10,7x2



**ANIMALS & VARIOUS**  
ANIMALI & VARI





**Honey bee**

Ape

art. cm.  
47382-06 11,6x8x3

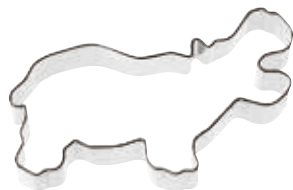

**Hippo**

Ippopotamo

art. cm.  
47404-04 11x7x3



**Ladybug**

Coccinella

art. cm.  
47404-05 8x8x3



**Butterfly**

Farfalla

art. cm.  
47371-08 8x7x3



**Snail**

Lumaca

art. cm.  
47404-02 11x6x3



**Fish**

Pesce

art. cm.  
47384-08 8x8x3



**Frog**

Rana

art. cm.  
47380-08 8x8x3



**Rooster**

Gallo

art. cm.  
47383-08 8x8x3



**Dolphin**

Delfino

art. cm.  
47384-01 5x9x3



**Seagull**

Gabbiano

art. cm.  
47386-08 11x6x3



**Cat**

Gatto

art. cm.  
47401-08 8x8x3



**Goose**

Oca

art. cm.  
47404-08 8x7x3



**Teddy bear**

Orsetto

art. cm.  
47375-08 8x8x3



**Teddy bear**  
Orsetto

art. cm.  
47375-01 6x9x3



**Camel**  
Cammello

art. cm.  
47404-01 9x8,6x3



**Elephant**  
Elefante

art. cm.  
47404-03 12x7x3





**Four leaf clover**

Quadrifoglio

art. cm.

47374-08 8x8X3

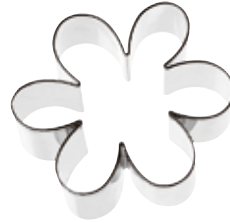

**Flower**

Fiore

art. cm.

47374-02 7x7,4x3



**Tulip**

Tulipano

art. cm.

47374-01 5,5x8x3



**Heart**

Cuore

art. cm.

47385-08 8x9x3



**Two hearts**

Due cuori

art. cm.

47385-01 9,4x5x3



**Rocking horse**

Cavallo a dondolo

art. cm.

47381-08 8x5x3



**Bow**

Fiocco

art. cm.

47373-02 6x8x3



**Apple**

Mela

art. cm.

47378-01 7,6x8,4x3



**Pirate ship**

Nave pirata

art. cm.

47370-03 8x8,4x3



**Airplane**

Aereo

art. cm.

47370-02 9x8x3

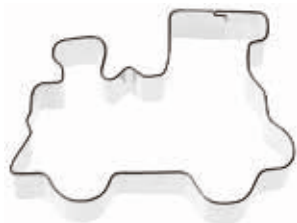

**Train**

Locomotiva

art. cm.

47370-01 10x7x3



**Suits of cards, set of 4 pcs**

Semi carte set 4 pz

art. cm.

47378-02 7,5x7,5x3





**Numbers, set of 9 pcs**

Numeri, set 9 pz

art. cm.  
47421-09 6,5x2,5



**Letters, set of 26 pcs**

Lettere, set 26 pz

art. cm.  
47422-26 6x2,5



**Round, set 6 pcs**

Cerchio, set 6 pz

art. cm.  
47425-01 4x3  
47425-02 5x3  
47425-03 6x3



**Square, set 6 pcs**

Quadro, set 6 pz

art. cm.  
47425-04 5x5x3  
47425-05 6x6x3



**Triangle, set 6 pcs**

Triangolo, set 6 pz

art. cm.  
47425-06 6x3



**Oval, set 6 pcs**

Ovale, set 6 pz

art. cm.  
47425-09 7,5x4,5x3



**Trapeze, set 6 pcs**

Trapezio, set 6 pz

art. cm.  
47425-08 9x6x3



**Rectangle, set 6 pcs**

Rettangolo, set 6 pz

art. cm.  
47425-10 5x3,5x3  
47425-11 6x5x3



**Drop, set 6 pcs**

Goccia, set 6 pz

art. cm.  
47425-26 9x3



**Hexagon, set 6 pcs**

Esagono, set 6 pz

art. cm.  
47425-29 5x3  
47425-30 6x3



**Heart, set 6 pcs**

Cuore, set 6 pz

art. cm.  
47425-32 6,5x3



**Square, set 6 pcs**

Quadro, set 6 pz

art. cm.  
47426-01 8x8x4,5



**Rectangle**

Rettangolo

art. cm.  
47426-07 12x6x4,5



**Doughnut cutter**

Tagliapasta per doughnuts

Donut-Ausstecher

Coupe-donuts

Cortadonuts

art. Ø cm. h. cm.  
47388-06 65-25 20  
47388-07 70-30 17  
47388-08 80-40 20



**Cinnamon star cutter**

Tagliapaste stelle

Zimstern-Ausstecher

Coupe-étoiles

Cortapasta Esterella

art. cm.  
47377-15 5x9,7

Spring mechanism. – Meccanismo a molla.



**Horseshoe, tin plate**

Ferro di cavallo, banda stagnata

Hufeisen, Weißblech

Fer à cheval, fer blanc

Herradura, hojalata

art. cm.  
47377-12 7x6x2

CUTTERS  
TAGLIAPASTA



**Round**

Rotondo

art.	Ø cm.	h. cm.
12943-03	3	3,5
12943-05	5	3,5
12943-07	7	3,5
12943-08	8	3,5
12943-10	10	3,5
12943-12	12	3,5



**Round, fluted**

Rotondo festonato

art.	Ø cm.	h. cm.
12944-03	3	3,5
12944-05	5	3,5
12944-07	7	3,5
12944-08	8	3,5
12944-10	10	3,5
12944-12	12	3,5



**Oval, fluted**

Ovale festonato

art.	cm.
12947-02	5,5x3,5x4
12947-03	7x4x4
12947-04	8,5x5x4
12947-05	10x6x4
12947-06	11x7x4
12947-07	13x5x4



**Set 6 pcs round pastry cutters**

Scatola tagliapasta rotondi, 6 pz

art.  
12943-13



**Set 6 pcs fluted round pastry cutters**

Scatola tagliapasta rotondi festonati, 6 pz

art.  
12944-13



**Set 6 pcs fluted oval pastry cutters**

Scatola tagliapasta ovali festonati, 6 pz

art.  
12947-13



**Dough plunger cutters w/extractor, 3 pcs**

Tagliapasta con espulsore, set 3 pz  
Ausstechformen mit Auswerfer, 3 Stk  
Emportes-pièces, 3 pcs  
Cortadores, 3 pz

art.	Ø cm.
47622-04	3,4,5

Holly. – Agrifoglio.



**Dough plunger cutters w/extractor, 4 pcs**

Tagliapasta con espulsore, set 4 pz  
Ausstechformen mit Auswerfer, 4 Stk  
Emportes-pièces, 4 pcs  
Cortadores, 4 pz

art.	Ø cm.
47622-26	1,2 - 2 - 2,8 - 3,5

Daisy. – Margherita.



**Dough plunger cutters w/extractor, 3 pcs**

Tagliapasta con espulsore, set 3 pz  
Ausstechformen mit Auswerfer, 3 Stk  
Emportes-pièces, 3 pcs  
Cortadores, 3 pz

art. Ø cm.

47622-01 3:5

**Petunie. – Petunia.**



**Dough plunger cutters w/extractor, 3 pcs**

Tagliapasta con espulsore, set 3 pz  
Ausstechformen mit Auswerfer, 3 Stk  
Emportes-pièces, 3 pcs  
Cortadores, 3 pz

art. Ø cm.

47622-02 2,5

**Flower. – Fiore.**



**Dough plunger cutters w/extractor, 3 pcs**

Tagliapasta con espulsore, set 3 pz  
Ausstechformen mit Auswerfer, 3 Stk  
Emportes-pièces, 3 pcs  
Cortadores, 3 pz

art. Ø cm.

47622-03 3:5

**Rose leaf. – Foglia di rosa.**



**SS**

**Set of 9 cutters**

Set 9 tagliapasta  
Satz 9 Ausstechformen  
Set 9 découpoirs  
Juego 9 cortadores

art. h. cm.

47837-09 0,5



**PA**

**Almont past knife**

Coltello per marzapane  
Marzipan-Messer  
Couteau à pâte d'amande  
Cuchillo para fondant/mazapán

art. l. cm.

47630-28 16,5



**PP**

**Marzipan set, 15 pcs**

Set 15 pezzi per marzapane  
Marzipan-Satz, 15 Stk.  
Set 15 outils à pâte d'amandes  
Set de 15 herramientas para decorar galletas

art.

47631-12



**PP**

**Marzipan set, 8 pcs**

Set 8 pezzi per marzapane  
Marzipan-Satz, 8 Stk.  
Set 8 outils à pâte d'amandes  
Set de 8 herramientas para decorar galletas

art.

47631-08



**SS**

**Set of 10 pcs dipping forks**

Set 10 forchettine pralineria  
Pralinen Gabelchen, 10 Stk.  
Jeu de 10 ébauchoirs  
Set de 10 herramientas para decorar chocolates

art.

47833-10



**SS**

**Set of 4 pcs dipping forks**

Set 4 forchettine pralineria  
Pralinen Gabelchen, 4 Stk.  
Jeu de 4 ébauchoirs  
Set de 4 herramientas para decorar chocolates

art.

47833-04



**SS**

**Set 2 decorating spoons**

Set 2 cucchiai decorazione  
Satz 2 Dekoration-Löffel  
Set 2 cuillères pour décorer  
2 cucharas para decoración

art. l. cm.

47831-02 19-23



**STAINLESS STEEL NOZZLES**  
**BOCCHETTE INOX**



**Set 12 pcs, one piece nozzles**

Set 12 bocchette unipezzo  
Tüllen Set 12 Stk. aus einem Stück gezogen  
Set 12 pcs douilles monobloc  
Surtido 12 boquillas monobloc

art.	Ø mm.	base ø mm.
47357-20	1x 0,6-1,2-1,5-1,9-2,4-3 3,6-4,8-5,6-6,4-6,8-7,6	18

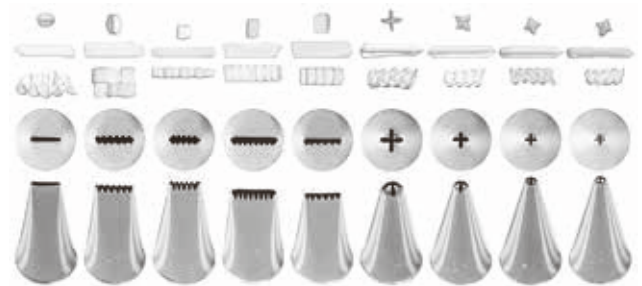

**Set 9 pcs, one piece nozzles**

Set 9 bocchette unipezzo  
Tüllen Set 9 Stk. aus einem Stück gezogen  
Set 9 pcs douilles monobloc  
Surtido 9 boquillas monobloc

art.	base ø mm.
47357-24	18



**Set 7 pcs, one piece nozzles**

Set 7 bocchette unipezzo  
Tüllen Set 7 Stk. aus einem Stück gezogen  
Set 7 pcs douilles monobloc  
Surtido 7 boquillas monobloc

art.	Ø mm.	base ø mm.
47357-21	1x 1,7-2,2-3,5-4,2-5-5,5-7	18



**Set 8 pcs, one piece nozzles**

Set 8 bocchette unipezzo  
Tüllen Set 8 Stk. aus einem Stück gezogen  
Set 8 pcs douilles monobloc  
Surtido 8 boquillas monobloc

art.	Ø mm.	base ø mm.
47357-22	1x 1-1,5-1,8-2,6-3-3,4-2,5-7	18





**Set 8 pcs, one piece nozzles**

Set 8 bocchette unipezzo

Tüllen Set 8 Stk. aus einem Stück gezogen

Set 8 pcs douilles monobloc

Surtido 8 boquillas monobloc

art. base ø mm.

47357-23 18

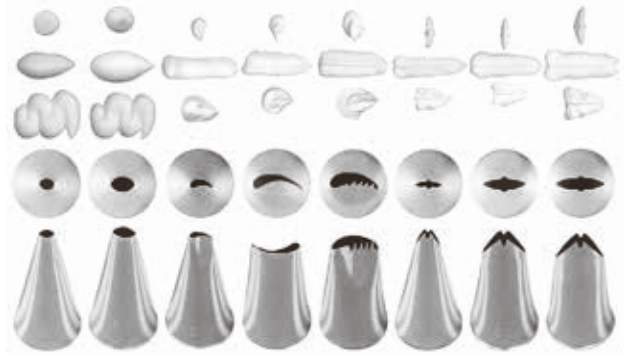

**Set 8 pcs, one piece nozzles**

Set 8 bocchette unipezzo

Tüllen Set 8 Stk. aus einem Stück gezogen

Set 8 pcs douilles monobloc

Surtido 8 boquillas monobloc

art. base ø mm.

47357-25 18



**Set 8 pcs, one piece nozzles**

Set 8 bocchette unipezzo

Tüllen Set 8 Stk. aus einem Stück gezogen

Set 8 pcs douilles monobloc

Surtido 8 boquillas monobloc

art. base ø mm.

47357-26 18

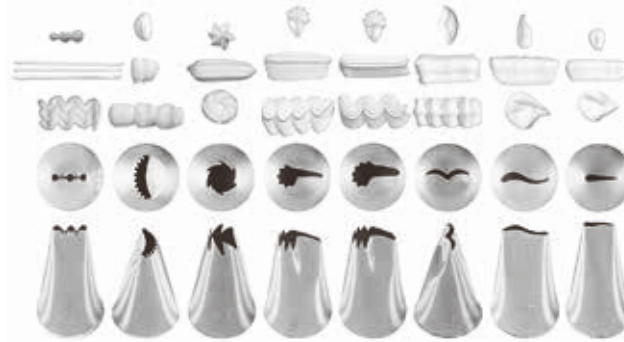

**Set 8 pcs, one piece nozzles**

Set 8 bocchette unipezzo

Tüllen Set 8 Stk. aus einem Stück gezogen

Set 8 pcs douilles monobloc

Surtido 8 boquillas monobloc

art. base ø mm.

47357-27 18



**Set 8 pcs, one piece nozzles**

Set 8 bocchette unipezzo

Tüllen Set 8 Stk. aus einem Stück gezogen

Set 8 pcs douilles monobloc

Surtido 8 boquillas monobloc

art. base ø mm.

47357-28 18

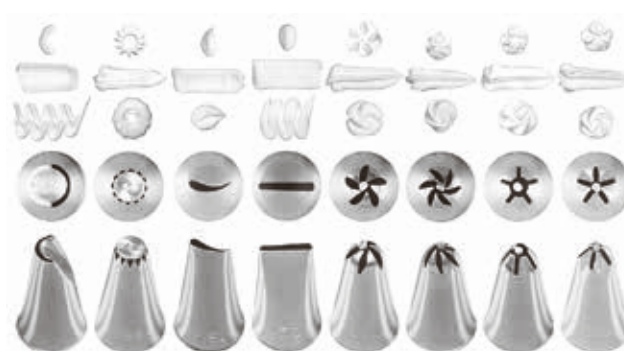

**Set 8 pcs, one piece nozzles**

Set 8 bocchette unipezzo

Tüllen Set 8 Stk. aus einem Stück gezogen

Set 8 pcs douilles monobloc

Surtido 8 boquillas monobloc

art. base ø mm.

47357-29 18





**Set 8 pcs, one piece nozzles**

Set 8 bocchette unipezzo  
Tüllen Set 8 Stk. aus einem Stück gezogen  
Set 8 pcs douilles monobloc  
Surtido 8 boquillas monobloc

art. base ø mm.

47357-30 18



**Set 8 pcs, one piece nozzles**

Set 8 bocchette unipezzo  
Tüllen Set 8 Stk. aus einem Stück gezogen  
Set 8 pcs douilles monobloc  
Surtido 8 boquillas monobloc

art. base ø mm.

47357-31 18



**Set 6 pcs, one piece nozzles**

Set 6 bocchette unipezzo  
Tüllen Set 6 Stk. aus einem Stück gezogen  
Set 6 pcs douilles monobloc  
Surtido 6 boquillas monobloc

art. base ø mm.

47357-06 25



**Set 6 pcs, one piece nozzles**

Set 6 bocchette unipezzo  
Tüllen Set 6 Stk. aus einem Stück gezogen  
Set 6 pcs douilles monobloc  
Surtido 6 boquillas monobloc

art. base ø mm.

47357-07 25



**Set 6 pcs, one piece nozzles**

Set 6 bocchette unipezzo  
Tüllen Set 6 Stk. aus einem Stück gezogen  
Set 6 pcs douilles monobloc  
Surtido 6 boquillas monobloc

art. base ø mm.

47357-08 25

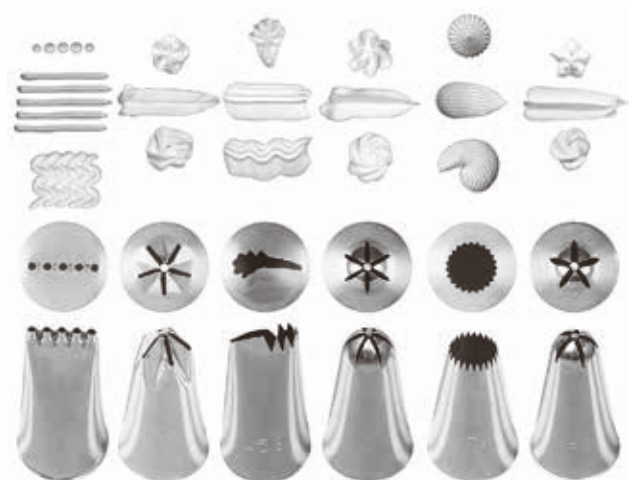

**Set 6 pcs, one piece nozzles**

Set 6 bocchette unipezzo  
Tüllen Set 6 Stk. aus einem Stück gezogen  
Set 6 pcs douilles monobloc  
Surtido 6 boquillas monobloc

art. base ø mm.

47357-09 25

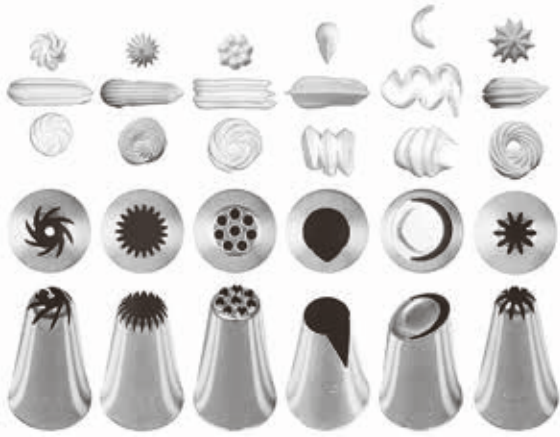

**Set 6 pcs, one piece nozzles**

Set 6 bocchette unipezzo

Tüllen Set 6 Stk. aus einem Stück gezogen

Set 6 pcs douilles monobloc

Surtido 6 boquillas monobloc

art. base ø mm.

47357-10 25



**Set 6 pcs, one piece nozzles**

Set 6 bocchette unipezzo

Tüllen Set 6 Stk. aus einem Stück gezogen

Set 6 pcs douilles monobloc

Surtido 6 boquillas monobloc

art. base ø mm.

47357-11 25



**Set 4 pcs, one piece nozzles**

Set 4 bocchette unipezzo

Tüllen Set 4 Stk. aus einem Stück gezogen

Set 4 pcs douilles monobloc

Surtido 4 boquillas monobloc

art. base ø mm.

47357-01 31



**Set 4 pcs, one piece nozzles**

Set 4 bocchette unipezzo

Tüllen Set 4 Stk. aus einem Stück gezogen

Set 4 pcs douilles monobloc

Surtido 4 boquillas monobloc

art. base ø mm.

47357-02 2x 31 - 2x 36



**Set 7 pcs, one piece nozzles**

Set 7 bocchette unipezzo

Tüllen Set 7 Stk. aus einem Stück gezogen

Set 7 pcs douilles monobloc

Surtido 7 boquillas monobloc

art. base ø mm.

47357-03 31





**Set 3x2 nozzles**

Set 3x2 bocchette

3x2 Stk. Tüllen

Set 3x2 pcs douilles

Juego 3x2 boquillas

art.	Ø mm.	stars
47350-01	2x 25	6
	2x 31	6
	2x 36	6



**Set 3x2 nozzles**

Set 3x2 bocchette

3x2 Stk. Tüllen

Set 3x2 pcs douilles

Juego 3x2 boquillas

art.	Ø mm.	stars
47351-01	2x 31	6
	2x 31	8
	2x 36	9



**Set 3x2 nozzles**

Set 3x2 bocchette

3x2 Stk. Tüllen

Set 3x2 pcs douilles

Juego 3x2 boquillas

art.	Ø mm.	stars
47352-01	2x 31	6
	2x 31	8
	2x 36	9



**Set 6 pcs, one piece nozzles**

Set 6 bocchette unipezzo

Tüllen Set 6 Stk. aus einem Stück gezogen

Set 6 pcs douilles monobloc

Surtido 6 boquillas monobloc

art.	Ø mm.	stars
47208-01	3,0	5
47208-02	3,0	6
47208-03	3,5	7
47208-04	5,0	8



**Set 6 pcs, one piece nozzles**

Set 6 bocchette unipezzo

Tüllen Set 6 Stk. aus einem Stück gezogen

Set 6 pcs douilles monobloc

Surtido 6 boquillas monobloc

art.	Ø mm.	stars
47208-05	5	5
47208-06	5	6
47208-07	6	7
47208-08	7	8



**Set 6 pcs, one piece nozzles**

Set 6 bocchette unipezzo

Tüllen Set 6 Stk. aus einem Stück gezogen

Set 6 pcs douilles monobloc

Surtido 6 boquillas monobloc

art.	Ø mm.	stars
47208-09	7	5
47208-10	7	6
47208-11	7	7
47208-12	9	8



**Set 6 pcs, one piece nozzles**

Set 6 bocchette unipezzo

Tüllen Set 6 Stk. aus einem Stück gezogen

Set 6 pcs douilles monobloc

Surtido 6 boquillas monobloc

art.	Ø mm.	stars
47208-13	11	5
47208-14	11	6
47208-15	11	7
47208-16	11	8



**Set 6 pcs, one piece nozzles**

Set 6 bocchette unipezzo

Tüllen Set 6 Stk. aus einem Stück gezogen

Set 6 pcs douilles monobloc

Surtido 6 boquillas monobloc

art.	Ø mm.	stars
47208-17	13	5
47208-18	13	6
47208-19	13	7
47208-20	13	8

**Set 6 pcs, one piece nozzles**

Set 6 bocchette unipezzo

Tüllen Set 6 Stk. aus einem Stück gezogen

Set 6 pcs douilles monobloc

Surtido 6 boquillas monobloc

art.	Ø mm.	stars
47208-21	18	5
47208-22	18	6
47208-23	18	7
47208-24	18	8



**Set 6 pcs, one piece nozzles**

Set 6 bocchette unipezzo

Tüllen Set 6 Stk. aus einem Stück gezogen

Set 6 pcs douilles monobloc

Surtido 6 boquillas monobloc

art.	Ø mm.	stars
47354-02	2	6
47354-04	4	6
47354-06	6	6
47354-08	8	6
47354-10	10	6
47354-12	12	7
47354-14	14	8
47354-16	16	9
47354-18	18	10

**Set 6 pcs, one piece nozzles**

Set 6 bocchette unipezzo

Tüllen Set 6 Stk. aus einem Stück gezogen

Set 6 pcs douilles monobloc

Surtido 6 boquillas monobloc

art.	Ø mm.	stars
47355-02	2,5	6
47355-04	4,0	6
47355-06	6,0	6
47355-08	8,0	7
47355-10	10	8
47355-12	12	10

**Set 6 pcs, one piece nozzles**

Set 6 bocchette unipezzo

Tüllen Set 6 Stk. aus einem Stück gezogen

Set 6 pcs douilles monobloc

Surtido 6 boquillas monobloc

art.	Ø mm.	stars
47356-02	2,0	5
47356-04	4,0	9
47356-06	5,5	9
47356-08	7,0	10
47356-10	8,5	12
47356-12	13,0	15
47356-14	14,5	16
47356-16	16,0	17
47356-18	17,5	18



**Set 6 pcs, one piece nozzles**

Set 6 bocchette unipezzo

Tüllen Set 6 Stk. aus einem Stück gezogen

Set 6 pcs douilles monobloc

Surtido 6 boquillas monobloc

art.	Ø mm.
47353-02	2
47353-04	4
47353-06	6
47353-08	8
47353-10	10
47353-12	12
47353-14	14
47353-16	16
47353-18	18
47353-20	20
47353-22	22
47353-24	24

**Set 6 pcs, one piece nozzles**

Set 6 bocchette unipezzo

Tüllen Set 6 Stk. aus einem Stück gezogen

Set 6 pcs douilles monobloc

Surtido 6 boquillas monobloc

art.	Ø mm.
47207-20	20
47207-25	25
47207-30	30

**Set 10 pcs Bismark nozzles**

Set 10 bocchette a imbuto

Fülltüllen Set 10 Stk.

Set 10 douilles à choux

Surtido 10 boquillas para relleno

art.	Ø mm.	l. mm.
47127-04	4	90
47127-06	6	75
47127-08	8	90



**Nozzle**  
Bocchetta decorativa  
Spritztülle  
Douille  
Boquilla

art.	Ø mm.	h. cm.
47357-50	55	6



**Nozzle**  
Bocchetta decorativa  
Spritztülle  
Douille  
Boquilla

art.	Ø mm.	h. cm.
47357-51	55	5,6



**Nozzle**  
Bocchetta decorativa  
Spritztülle  
Douille  
Boquilla

art.	Ø mm.	h. cm.
47357-40	32	6,0
47357-41	32	5,7
47357-42	32	5,7
47357-43	32	5,7
47357-44	32	5,7



**PP**

**Set of 6 nozzles**  
Set 6 bocchette  
Tüllen Set, 6 Stk  
Set 6 douilles  
Juego 6 boquillas

art.	Ø mm.
47214-86	5-7-9-11-13-15



**PP**

**Set of 6 nozzles**  
Set 6 bocchette  
Tüllen Set, 6 Stk  
Set 6 douilles  
Juego 6 boquillas

art.	Ø mm.
47215-86	3-5-7-9-11-13



**PP**

**Set of 8 nozzles**  
Set 8 bocchette  
Tüllen Set, 8 Stk  
Set 8 douilles  
Juego 8 boquillas

47216-88
----------



**PP**

**Set of 12 nozzles**  
Set 12 bocchette  
Tüllen Set, 12 Stk  
Set 12 douilles  
Juego 12 boquillas

art.	Ø mm.
47618-10	2>10
47618-20	10>20



**PC**

**Set of 12 nozzles**  
Set 12 bocchette  
Tüllen Set, 12 Stk  
Set 12 douilles  
Juego 12 boquillas

47250-12
----------

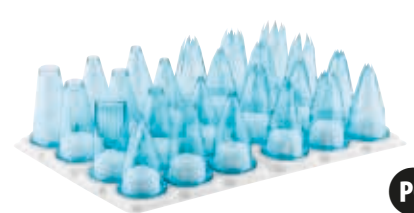

**PC**

**Set of 24 nozzles**  
Set 24 bocchette  
Tüllen Set, 24 Stk  
Set 24 douilles  
Juego 24 boquillas

47250-24
----------



**Flower nozzles 12 pcs**

Bocchette floreali 12 pz

Spritztüllen 12 Stk

Douille fleurs 12 pcs

Boquillas florales 12 pz

art.

47357-38



**Set of 29 nozzles**

Set 29 bocchette

Tüllen Set, 29 Stk

Set 29 douilles

Juego 29 boquillas

art.

47219-29

**26 tubes, 2 flower nails, 1 standard coupler. – 26 bocchette, 2 chiodi per fiori, 1 adattatore standard.**



**Set of 38 nozzles**

Set 38 bocchette

Tüllen Set, 38 Stk

Set 38 douilles

Juego 38 boquillas

art.

47219-38

**35 tubes, 1 medium coupler, 1 large coupler. 35 bocchette, 1 adattatore medio, 1 grande.**



**Set of 55 nozzles**

Set 55 bocchette

Tüllen Set, 55 Stk

Set 55 douilles

Juego 55 boquillas

art.

47219-55

**52 tubes, 2 flower nails, 1 standard coupler. – 52 bocchette, 2 chiodi per fiori, 1 adattatore standard.**



**Set of 13 assorted nozzles**

Set 13 bocchette assortite

Tüllensortiment, 13 Stk

Set 13 douilles assorties

Juego 13 boquillas

art.

47251-00

**8 tubes mm. 1/2/3/5/7/9/13/15, 2 adapters, 2 lids, 1 brush. 8 bocchette mm. 1/2/3/5/7/9/13/15, 2 adattatori, 2 tappi, 1 bruschino.**



**Set of 13 assorted nozzles**

Set 13 bocchette assortite

Tüllensortiment, 13 Stk

Set 13 douilles assorties

Juego 13 boquillas

art.

47251-01

**8 star tubes mm. 4/5/7/9 (6 points), 7/9/11/13 (8 points), 2 adapters, 2 lids, 1 brush. – 8 bocchette foro stella mm. 4/5/7/9 (6 punte), 7/9/11/13 (8 punte), 2 adattatori, 2 tappi, 1 bruschino.**



**Set of 13 assorted nozzles**

Set 13 bocchette assortite  
Tüllensortiment, 13 Stk  
Set 13 douilles assorties  
Juego 13 boquillas

art. ....

47251-02

**8 tubes, 1 bismark tube, 2 adapters, 2 lids.**

8 bocchette, 1 bocchetta a imbuto, 2 adattatori, 2 tappi.



**Set of 13 assorted nozzles**

Set 13 bocchette assortite  
Tüllensortiment, 13 Stk  
Set 13 douilles assorties  
Juego 13 boquillas

art. ....

47251-03

**8 star tubes mm. 4,5/5,5/6/7,5/8/8/9/10, 2 adapters, 2 lids, 1 brush. – 8**

bocchette foro stella mm. 4,5/5,5/6/7,5/8/8/9/10, 2 adattatori, 2 tappi, 1 bruschino.



**External piping tip adapter**

Adattatore per bocchette  
Adapter für Spritztüllen  
Adaptateur à douilles  
Adaptador para boquillas

art.      Ø mm.    des.

47212-01    18    STANDARD



**External piping tip adapter**

Adattatore per bocchette  
Adapter für Spritztüllen  
Adaptateur à douilles  
Adaptador para boquillas

art.      Ø mm.    des.

47212-02    25-31    MEDIUM



**External piping tip adapter**

Adattatore per bocchette  
Adapter für Spritztüllen  
Adaptateur à douilles  
Adaptador para boquillas

art.      Ø mm.    des.

47212-03    36    LARGE



**Nozzles adapter, 2 pcs**

Adattatori per bocchette, 2 pz  
Spritztüllen-Adapter, 2 Stk  
Adaptateurs à douilles, 2 pièces  
Adaptadores boquillas, 2 piezas

art. ....

47212-05

**To prepare decorations with 2 or 3 colours.  
Suitable for piping tips Ø30 h 50 mm.**

Per decorazioni a 2 o 3 colori. Adatte a bocchette  
Ø30 h 50 mm.



**Pastry tube brush, 6 pcs**

Bruschino per bocchette, 6 pz  
Tüllen-Bürste, 6 Stk  
Brosse à douilles, 6 pcs  
Cepillo para boquillas, 6 pz

art.      Ø cm.    l. cm.

47200-01    0,8    10

47200-02    0,5-2,4    12,5





**Cream roll molds, 10 pcs**

Cannoli, 10 pz  
Sahnerolle, konisch/gerade, 10 Stk  
Rouleau à fromage, 10 pcs  
Rodillos queso, 10 pz

art.	Ø mm.	l. mm.
47020-15	15	92
47020-20	22	142
47020-30	10-25	139
47020-35	20-25	171



**Cream horn molds, 10 pcs**

Cornetti, 10 pz  
Schillerlockenform, 10 Stk  
Moulet à cornet, 10 pcs  
Moldes para conos, 10 pz

art.	Ø mm.	l. mm.
47021-35	34	110
47021-45	47	161



**Cream horn molds, 10 pcs**

Cornetti, 10 pz  
Schillerlockenform, 10 Stk  
Moulet à cornet, 10 pcs  
Moldes para conos, 10 pz

art.	cm.
47021-30	3x12



**Decorating set 8 pcs**

Kit decoro 8 pezzi  
Dekorations-Set, 8-teilig  
Set 8 pcs à décorer  
Juego 8 piezas para decorar

art.
47120-01

**6 small tubes, 1 standard coupler, 1 bag cm. 35**  
6 bocchette piccole, 1 adattatore standard, 1 sacchetto 35 cm.



**Decorating set 8 pcs**

Kit decoro 8 pezzi  
Dekorations-Set, 8-teilig  
Set 8 pcs à décorer  
Juego 8 piezas para decorar

art.
47120-02

**6 medium tubes, 1 medium coupler, 1 bag cm. 40.** – 6 bocchette medie, 1 adattatore medio, 1 sacchetto 40 cm.



**Icing bag**

Sacchetto per decorare  
Spritzbeutel  
Sac à dresser  
Mangas para decorar

art.	h. cm.	U. Pack
47106-28	28	6
47106-34	34	6
47106-40	40	6
47106-46	46	6
47106-50	50	6

**Synthetic fibre with multi-layer water-proof plastic coating.**



**Icing bag**

Sacchetto per decorare  
Spritzbeutel  
Sac à dresser  
Mangas para decorar

art.	h. cm.	U. Pack
47106-55	55	6
47106-60	60	6
47106-65	65	6
47106-70	70	6
47106-75	75	6

**Fibra sintetica con rivestimento a strati in plastica impermeabile.**



**Icing bag**

Sacchetto per decorare  
Spritzbeutel  
Sac à dresser  
Mangas para decorar

art.	h. cm.	U. Pack
47105-28	28	6
47105-34	34	6
47105-40	40	6
47105-46	46	6
47105-50	50	6

**With reinforced tip, seam and hanger. Cotton with multi-layer water-proof plastic coating.**



**Icing bag**

Sacchetto per decorare  
Spritzbeutel  
Sac à dresser  
Mangas para decorar

art.	h. cm.	U. Pack
47105-55	55	6
47105-60	60	6
47105-65	65	6
47105-70	70	6
47105-75	75	6

**Con punta rinforzata, orlo e gancio. Cotone con rivestimento a strati in plastica impermeabile.**





**Icing bag**

Sacchetto per decorare  
Spritzbeutel  
Sac à dresser

Mangas para decorar

art.	h. cm.	U. Pack
47119-30	30	6
47119-35	35	6
47119-40	40	6
47119-45	45	6
47119-50	50	6
47119-60	60	6

**With reinforced tip, seam and hanger. Polyurethan with nylon coating. High frequency electric seaming.** – Con punta rinforzata, orlo e gancio. Poliuretano con rivestimento in nylon. Saldatura ad alta frequenza.



**PE**

**Double pastry bag**

Sacchetto per decorare doppio  
Doppeldressierbeutel  
Sac à dresser, double

Mangas para decorar, doble

art.	my	cm.	pcs/pz
47104-45	70	45,5x30,5	75

**Disposable. For 2 ingredients. Closed tip, can be used without tube.**

Monouso. Per 2 ingredienti. Punta chiusa, può essere utilizzato senza bocchette.



**GRIP EFFECT**

**PE**

**Disposable icing bag**

Sacchetto per decorare, monouso  
Einwegspritzbeutel  
Sac à dresser jetable  
Mangas desechables

art.	my	h. cm.	pcs/pz
47118-30	80	30	100
47118-40	80	40	100
47118-55	80	55	100
47118-65	80	65	100



**SUPER RESISTANT**

**PE**

**Disposable icing bag**

Sacchetto per decorare, monouso  
Einwegspritzbeutel  
Sac à dresser jetable  
Mangas desechables

art.	my	h. cm.	pcs/pz
47111-30	80	30	100
47111-40	80	40	100
47111-46	80	55	100
47111-55	80	65	100



**HOT RESISTANT**

**NEW**

**PE**

**Disposable icing bag**

Sacchetto per decorare, monouso  
Einwegspritzbeutel  
Sac à dresser jetable  
Mangas desechables

art.	my	h. cm.	pcs/pz
47114-40	100	40	80
47114-55	100	55	80



**Icing bag, polyurethane**

Sacchetto per decorare, poliuretano  
Spritzbeutel, Polyurethan  
Sac à dresser, polyuréthane  
Mangas para decorar, poliuretano

art.	h. cm.
47112-34	34
47112-45	45
47112-50	50



**BPA FREE**

**PP**

**Bag clip**

Clip chiudi sacco  
Verschluss-Clip  
Clip ferme sachet  
Pinza cierra bolsas

art.	cm.	pcs/pz
42908-24	21	1

**Freezer, dishwasher and microwave safe. Safe to use with food.** – Idonei ad uso in freezer, lavastoviglie e microonde. Per alimenti.



**SS**

**Cookie press and icing set 20 pcs**

Siringa per pasticceria, set 20 pezzi  
Gebäckspritze-Satz, 20 Stk.  
Seringue à biscuits, jeu 20 pcs  
Juego pistola repostería, juego 20 pcs.

art.	ml.
47010-20	250

**For a correct use of the syringe we suggest shortbread dough.** – Per un utilizzo ottimale della siringa suggeriamo la frolla montata.

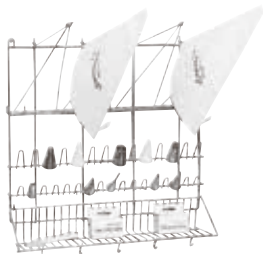

SS

**Icing bags & nozzles wall rack**  
Espositore sacchetti/bocchette  
Spritzbeutel-/ u. Tüllenaufhänger  
Séchoir à poche et douilles  
Secador mangas y boquillas

art. dim. cm.  
47113-03 50x42x50



SS

**Wall rack for icing bags**  
Espositore per sacchetti  
Spritzbeutelaufräger  
Séchoir à poche  
Secador cuelga-mangas

art. dim. cm.  
47107-00 50x42x26

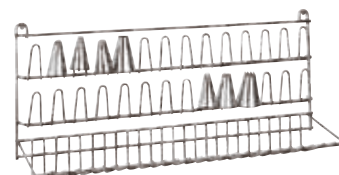

SS

**Wall rack for nozzles**  
Espositore per bocchette  
Tüllenaufhänger  
Séchoir à douilles  
Secador boquillas

art. dim. cm.  
47108-00 50x13x24



PP

**Icing bag holder**  
Vaso porta sacchetto  
Spritzbeutel-Absetzständer  
Support à poches  
Soporte para mangas

art. Ø cm. h. cm.  
47110-23 19,5 23



**Cake plate, swivel base, aluminum**  
Girello, alluminio  
Tortendrehplatte, aluminium  
Guéridon plaque tournante, alu  
Pedestal giratorio para tartas, aluminio

art. Ø cm. h. cm.  
47101-30 30 10



**Cake plate, swivel base, aluminum**  
Girello, alluminio  
Tortendrehplatte, aluminium  
Guéridon plaque tournante, alu  
Pedestal giratorio para tartas, aluminio

art. dim. cm.  
47101-40 30x40x10



MF

**Cake-plate, swivel base**  
Girello per decorazione torte  
Tortendrehplatte  
Guéridon plaque tournante  
Pedestal giratorio para tartas

art. Ø cm. h. cm.  
47103-32 32 10



PE

**Protection cover**  
Campana  
Abdeckhauben  
Cloche  
Tapa

art. Ø cm. h. cm.  
47103-30 30 12



SS

**Cake peel**  
Pala per torte  
Tortenschaufel  
Pelle à tarte  
Pala para tartas

art. Ø cm. dim. cm.  
47094-30 30 27x26



**Doilies**  
Pizzi sottotorta  
Tortenspitzen, Rosendekor  
Dentelles décor rose  
Blondas

art. dim. cm. pcs/pz  
47687-24 18-25 250



**Doilies**  
Pizzi sottotorta  
Tortenspitzen, Rosendekor  
Dentelles décor rose  
Blondas

art. dim. cm. pcs/pz  
47686-10 6-10 250  
47686-12 6,5-12 250  
47686-14 8-14 250  
47686-17 9,5-16,5 250  
47686-22 12,5-22 100  
47686-24 15-24 100



**Doilies**  
Pizzi sottotorta  
Tortenspitzen, Rosendekor  
Dentelles décor rose  
Blondas

art. dim. cm. pcs/pz  
47686-26 16-27 100  
47686-30 19-30 100  
47686-33 20-32 100  
47686-36 32-36 100  
47686-42 25-42 100



**Draining rack**  
Griglia di colaggio  
Überziehgitter  
Grille à glacer  
Rejilla

art.	dim. cm.
44430-60	60x40

**Frame ø mm 5, 2 cross-bars, 29 wires ø 2 mm.**  
Quadro ø mm 5, 2 traverse, 29 fili ø 2 mm.

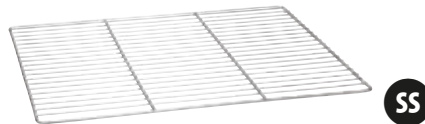

**Draining rack**  
Griglia di colaggio  
Überziehgitter  
Grille à glacer  
Rejilla

art.	dim. cm.
44430-61	60x40

**Frame ø mm 6, 2 cross-bars, 24 wires ø 3 mm.**  
Quadro ø mm 6, 2traverse, 24 fili ø 3 mm.



**Draining rack**  
Griglia di colaggio  
Überziehgitter  
Grille à glacer  
Rejilla

art.	dim. cm.
44431-46	46x30,5x2,5
44431-60	60x40x2,5

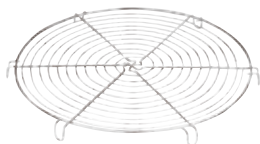

**Cake cooling tray, chromed**  
Griglia di raffreddamento, cromata  
Tortengitter, verchromt  
Grille ronde à tourte, chromé  
Rejilla para tortas, cromada

art.	Ø cm.
47098-18	18,5
47098-22	22,0
47098-26	26,0
47098-30	30,0



**Baking tray, aluminum**  
Teglia, alluminio  
Backblech, Aluminium  
Plaque à cuisson, aluminium  
Placa pastelería, aluminio

art.	GN	dim. cm.
41744-32	1/1	32,5x53x1
41744-53	2/1	53x65x1
41744-60	-	60x40x1



**Baking tray, perforated, aluminum**  
Teglia forata, alluminio  
Backblech, Aluminium, gelocht  
Plaque perforée, aluminium  
Placa pastelería perforada, aluminio

art.	GN	dim. cm.
41756-30	-	30x40x1
41756-32	1/1	32,5x53x1
41756-53	2/1	53x65x1
41756-60	-	60x40x1



**Baking tray, alusteel**  
Teglia rettangolare, alluminata  
Backblech mit Aluminiumüberzug  
Plaque, tôle aluminitée  
Placa pastelería, aluminizada

art.	dim. cm.
41746-60	60x40x2



**Baking tray, alusteel**  
Teglia rettangolare, alluminata  
Backblech mit Aluminiumüberzug  
Plaque, tôle aluminitée  
Placa pastelería, aluminizada

art.	dim. cm.
41751-30	30x23x3
41751-35	35x28x3
41751-40	40x30x3
41751-50	50x35x3
41751-60	60x40x3
41751-65	65x45x3

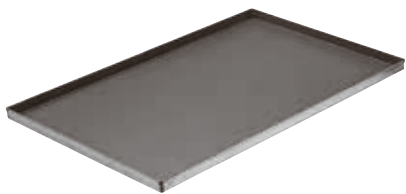

**Baking tray, non stick coated**  
Teglia rettangolare, antiaderente  
Backblech mit Antihafbeschichtung  
Plaque revêtement anti-adhésif  
Placa pastelería anti-adherente

art.	dim. cm.
41747-60	60x40x2



**Baking tray, silicone coated**  
Teglia, siliconata  
Backblech, Silikonbeschichtet  
Plaque, revêtement silicone  
Placa pastelería siliconada

art.	GN	dim. cm.
41743-32	1/1	32,5x53x1
41743-53	2/1	53x65x1
41743-60	-	60x40x1



**Baking tray, perforated, silicone coated**  
Teglia forata, siliconata  
Backblech, gelocht, Silikonbeschichtet  
Plaque perforée, revêtement silicone  
Placa perforada siliconada

art.	GN	dim. cm.
41753-30	-	30x40x1
41753-32	1/1	32,5x53x1
41753-53	2/1	53x65x1
41753-60	-	60x40x1



**Bread mold, blue steel**  
Bacinella carré, ferro blu  
Brotform, Blaublech  
Pain de mie, tôle bleuie  
Molde, hierro

art.	dim. cm.
41748-20	20x10x10
41748-30	30x10x10
41748-35	35x10x10
41748-40	40x10x10
41748-50	50x10x10



**Bread mold, alusteel**  
Bacinella carré, alluminata  
Brotform mit Aluminiumüberzug  
Pain de mie, tôle aluminitée  
Molde, acero aluminizado

art.	dim. cm.
41750-20	20x10x10
41750-30	30x10x10
41750-40	40x10x10
41750-41	40x15x15
41750-50	50x10x10



**Confectionery funnel**  
Imbuto colatore  
Likör- u. Fondanttrichter  
Entonnoir à fondant  
Embudo colador

art.	Ø cm.	h. cm.	lt.
47800-22	22	21	2

**Supplied with 3 nozzles ø 2, 4, 6 mm.**  
Con 3 bocchette ø 2, 4, 6 mm.



**Confectionery funnel**  
Imbuto colatore  
Likör- u. Fondanttrichter  
Entonnoir à fondant  
Embudo colador

art.	Ø cm.	h. cm.	lt.
47801-20	14	20	0,9

**Supplied with 3 nozzles ø 4, 6, 7,5 mm.**  
Con 3 bocchette ø 4, 6, 7,5 mm.



**Cream dispenser**  
Dosa creme  
Dosierer  
Doseur à crème  
Dosificador

art.	dim. cm.
47612-01	20x16x23



**Cream injector, cast aluminum**  
Dosatrice per creme, alluminio pressofuso  
Gebäkfüllmaschine  
Entonnoir à crème  
Dosificador de porciones

art.	dim. cm.	lt.
47694-03	44x25	3

**Funnel, cylinder, piston, injector, lever and thrust rib in s/s. Piston: ø 24 mm. Doses: 1-12 gr.**  
Imbuto, cilindro, pistone, iniettore, leva e nasello di spinta in acciaio inox. Pistone: ø 24 mm. Dosi: 1-12 gr.



SS

PC

SS



**Caramelising rod**  
Caramellizzatore  
Caramelisier-Eisen  
Fer à caraméliser  
Quemador

art.	Ø cm.
47846-10	10,5



**Electric caramelising rod**  
Caramellizzatore elettrico  
Caramelisier-Eisen, elektrisch  
Fer à caraméliser électrique  
Quemador eléctrico

art.	Ø cm.	kW
47847-10	10	0,65
47847-12	12	1,00



**Electric caramelising rod**  
Caramellizzatore elettrico  
Caramelisier-Eisen, elektrisch  
Fer à caraméliser électrique  
Quemador eléctrico

art.	l. cm.	kW
47847-23	23	1,5



**Electric spray gun**  
Pistola elettrica  
Sprühpistole, elektrisch  
Pistolet électrique  
Pistola eléctrica

art.	ml.	W
47848-07	700	60

**Bar 0-160, rpm 250 - For butter, oil, fat, wax, jelly, jam, chocolate, releasing agents and emulsions. Usable for hot liquids max. 65 °C. Nozzle 0,6 mm.** – Per burro, oli, cera, gelatina, marmellata, cioccolata, antiagglomeranti ed emulsionanti. Per liquidi caldi max. 65°C. Bocchetta 0,6 mm.



**Airbrush compressor**  
Compressore per penna aerografa  
Airbrush Kompressor  
Compresseur  
Compresor

art.	dim. cm.	kW
47844-06	16x30x23	0,2

**Bar 4.**



**Airbrush, double action**  
Penna aerografa, doppia azione  
Airbrush-Pistole, Doppelaktion  
Aérographe, dual action  
Equipo aerógrafo, doble acción

art.	Ø mm.	cap.
47844-02	0,3	7 cm3



**Airbrush stand**  
Supporto penna aerografa  
Airbrush-Pistole Gestell  
Support aérographe  
Soporte aerógrafo

art.
47844-01



**Sugar lamp**  
Lampada per zucchero  
Zuckerlampe  
Lampe à sucre  
Lámpara para azúcar

art.	dim. cm.
47840-11	61x41x50

**Infrared lamp, 3 selection powers 500-1000-1500W. Cable included.** – Lampada infrarossi con 3 potenze selezionabili, 500-1000-1500W. Incl. cavo di alimentazione.





NEW  
ABS

**Tempering unit**

Temperatrice  
Temperiergerät  
Tempereuse  
Templadora

art. Ø cm. h. cm. lt.  
47698-01 20,5 21,2 1,7

**Ideal for chocolate coatings of ice creams on sticks. Removable anodized aluminum tank.**  
Ideale per coperture in cioccolato di gelati su stecco. Vasca estraibile in alluminio anodizzato.



NEW  
ABS

**Tempering unit**

Temperatrice  
Temperiergerät  
Tempereuse  
Templadora

art. Ø cm. h. cm. lt.  
47698-02 26 16 1,8

**Mini dry melter, allows to process tiny chocolate quantities. Practical removable tank.**  
Mini scioglitore a secco, adatto per piccole produzioni. Pratica vasca estraibile



SS  
ABS

**Tempering unit**

Temperatrice  
Temperiergerät  
Tempereuse  
Templadora

art. dim. cm. lt.  
47698-03 40x24x13,5 3,6  
47698-06 40x33x13,5 6,0

**Analog tempering units. Different wirings upon request.** – Temperatrici analogiche. Su richiesta cablaggio: GB/USA/GIAPPONE/AUSTRALIA/CINA.



NEW  
ABS  
SS

**Tempering unit, digital**

Temperatrice digitale  
Temperiergerät, digital  
Tempereuse digitale  
Templadora digital

art. dim. cm. lt.  
47698-07 40x33x13,5 6,0

**With thermal probe. Tempering manually adjustable or following the 3 programs: white, milk and dark chocolate.** – Con sonda termica. Temperaggio regolabile manualmente o seguendo i 3 programmi per cioccolato bianco, al latte e fondente.



**Chef's torch**

Cannello professionale  
Profı-Wärmepistole  
Chalumeau de cuisine  
Soplete cocina

art. dim. cm. ml.  
47841-03 8x7x16 200



**Chef's torch**

Cannello professionale  
Profı-Wärmepistole  
Chalumeau de cuisine  
Soplete cocina

art. dim. cm. ml.  
47841-04 12x7x18 280



**Sugar bulb**

Pompetta con terminale in rame  
Blaszuckerspritze  
Poire à sucre soufflé  
Pera para azúcar soplado

art.  
47838-00



**Sugar/jam thermometer**

Termometro per zucchero/marmellata  
Zucker- und Marmeladenthermometer  
Thermomètre à sucre et confiture  
Termómetro azúcar y mermelada

art. scala °C  
47843-05 2°C +40+200°C

**Brass.** – Ottone. Dim. 4,7x20 cm.



**Sugar thermometer**

Termometro per zucchero  
Zuckerthermometer  
Thermomètre à sucre  
Termometro para azúcar

art. scala °C  
47843-00 1°C +80+200

SS





SS

**Sugar thermometer holder**

Reggi caramellometro  
Zuckerthermometer-Träger  
Support pour thermomètre à sucre  
Soporte para termometro azúcar

art.	h. cm.
47842-00	32



**Syrup density meter test tube**

Provetta alimentare graduata, plastica  
Sirup-Hydrometer-Becher  
Eprouvette pèse-sirop  
Probeta aerómetro

art.	Ø cm.	h. cm.	ml.
49703-01	3	25	100

**Can be sterilized up to 120°C.**  
Sterilizzabile fino a 120°C.



**Syrup density meter**

Pesa sciroppo (densimetro)  
Sirup-Hydrometer  
Pèse-sirop  
Aerómetro

art.	l. cm.
49703-00	12,5

**Temp.: 20°C - gr./ml./°Bé: 1.100/1.400/15-40 - Div.: 0,010 g/ml/2°Bé**



PA+  
plus

**Angular spatula**

Spatola angolare  
Winkelpalette  
Spatule angulaire  
Espátula angular

art.	l. cm.
12909-12	12
12909-23	23



ABS

**Smoother**

Stendipasta  
Teig-Glätter  
Lisse-pâte  
Espátula para alisar

art.	dim. cm.
47627-01	16x8



**Biscuit spatula**

Spatola per biscuit  
Biscuit-Spachtel  
Spatule à biscuit  
Espátula para biscuit

art.	l. cm.
47626-55	55,5



**Ruler**

Riga  
Lineal  
Règle  
Regla

art.	l. cm.
47033-50	60

**5 divisions cm 12 and 7 divisions cm 8.**  
5 divisioni 12 cm e 7 da 8 cm.



**Cake slicer**

Lira per pan di Spagna  
Tortendrahtschneider  
Lyre à genoise  
Cortador de pasteles

art.	Ø cm.	h. cm.
47031-44	30	20>60



**Cake slicer, 3 cutting wires**

Lira per pan di Spagna, 3 fili  
Tortendrahtschneider, 3 Drähte  
Lyre à genoise, 3 lames  
Cortador de pasteles 3 alambres

art.	Ø cm.	h. cm.
47031-46	46	10>90





#### Mini guitar

Chitarra mini, 12  
Praliné-Schneideapparat  
Appareil à couper les pralinés  
Cortador para pasteles

art. dim. cm.

47692-03 24x24

**Includes a 22 mm frame and s/steel plate, 1 plastic spatula and accessories for maintenance. Do not use for frozen pies, chocolate bars or generally hard paste.** – Include un telaio da 22 mm e piatto inox, 1 spatola plastica, accessori per la manutenzione. Non usare per torte congelate, tavolette di cioccolato, impasti duri in genere.

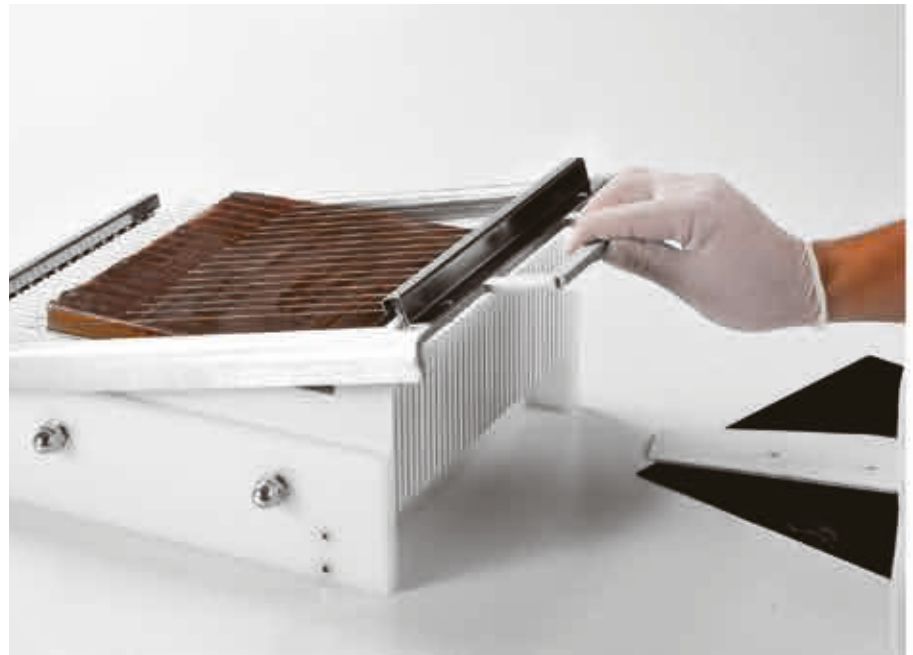

#### Base for ganache and 4 frames

Base per ganache + 4 telai  
Basis und 4 Rahmen für Ganache  
Base et 4 cadres à ganache  
Base y 4 cuadros para ganache

art. dim. cm.

47693-00 39x45x13

**Includes 2 frames 3 mm, 2 frames 5 mm, 1 spatula and Teflon base. Ganache's size 24x24 cm.** – Include 2 telai 3 mm, 2 telai 5 mm, 1 spatola e base in teflon. Misura ganache 24x24 cm.

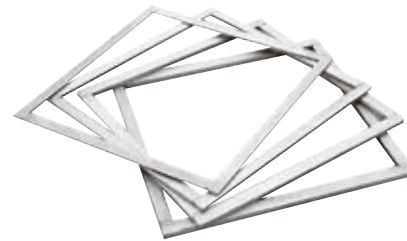

SS

#### Frames

Quadri per ganache  
Rahmen  
Cadres  
Cuadros

art. dim. cm. int. cm.

47693-03 40x40x0,3 36x36

47693-05 40x40x0,5 36x36

47693-10 40x40x1,0 36x36

47693-15 40x40x1,5 36x36



#### Guitar

Chitarra  
Praliné-Schneideapparat  
Appareil à couper les pralinés  
Cortador para pasteles

art. dim. cm.

47692-01 39x45x13

**PST plastic base, 3 stainless steel cutting frames of 22,5 - 30 and 45 mm. Including 1 s/s sheet, plastic spatula, 3 spare wires, 2 wires fixing spanners.** Base in PST, 4 telai inox da 22,5 - 30 e 45 mm. Inclusi 1 piatto inox, racla in PST, 3 fili di ricambio, 2 chiavi per fissaggio dei fili.



#### Double guitar

Chitarra doppia  
Praliné-Schneideapparat  
Appareil à couper les pralinés  
Cortador para pasteles

art. dim. cm.

47692-02 39x45x13

**PST base, 4 stainless steel cutting frames of 22,5 - 30 - 45 mm. and fixed side cutting frame 30 mm. Including 1 s/s sheet, plastic spatula, 3 spare wires, 2 wires fixing spanners.** – Base in PST, 4 telai inox da 22,5 - 30 - 45 e laterale fisso da 30 mm. Inclusi 1 piatto inox, racla in PST, 3 fili di ricambio, 2 chiavi per fissaggio dei fili.





SS

**Expanding pastry cutter**

Tagliapasta estensibile

Teigschneider

Rouleau extensible

Cortapastas extensible

art.	Ø cm.	l. cm.
47820-05	5,5	24
47820-07	5,5	24



SS

**Expanding pastry cutter**

Tagliapasta estensibile

Teigschneider

Rouleau extensible

Cortapastas extensible

art.	Ø cm.
47830-05	9,5
47830-07	9,5



SS

**Expanding pastry cutter**

Tagliapasta estensibile

Teigschneider

Rouleau extensible

Cortapastas extensible

art.	Ø cm.	l. cm.
47821-05	5,5	24
47821-07	5,5	24



SS

**Expanding pastry cutter**

Tagliapasta estensibile

Teigschneider

Rouleau extensible

Cortapastas extensible

art.	Ø cm.	l. cm.
47822-05	5,5	28
47822-07	5,5	28



SS

**Pastry wheel, plain**

Rotella taglia pasta liscia

Teigrädchen, glatt

Roulette à pâte lisse

Ruleta cortapasta

art.	Ø cm.	l. cm.
18325-01	5,5	18



SS

**Pastry wheel, fluted**

Rotella taglia pasta ondulata

Teigrädchen, gewellt

Roulette à pâte cannelée

Ruleta cortapasta acanalada

art.	Ø cm.	l. cm.
18325-02	5,5	18



SS

**Double pastry wheel**

Rotella taglia pasta lama doppia

Teigrädchen, glatt u. gewellt

Roulette à pâte double

Ruleta cortapasta doble

art.	Ø cm.	l. cm.
18325-03	5,5	18



**Cutting roller, POM**

Rullo tagliapasta, POM

Rollmesser, POM

Rouleau à lamelles, POM

Rodillo, POM

art.	cm.
47026-06	6



**Spiked roller, POM**

Rullo bucasfoglia, POM

Stipprolle, POM

Pique-pâte, POM

Rodillo, POM

art.	cm.
47024-06	6,0
47024-10	11,5



**Cutting roller, POM**

Rullo per losanghe, POM

Rollmesser, POM

Rouleau à losanges, POM

Rodillo a rombos, POM

art.	cm.
47025-06	6,0
47025-10	11,5



SS

**Spiked roller**

Rullo bucasfoglia

Stipprolle

Pique-pâte

Rodillo

art.	cm.
47028-12	12



SS

**Cutting roller**

Rullo per losanghe

Rollmesser

Rouleau à losanges

Rodillo a rombos

art.	cm.
47029-12	12



PP  
SS

**Croissant cutter**  
Taglia croissants  
Dreieckschneidewalze  
Coupe-croissants  
Cortador para croissants

art.	dim. cm.
47027-11	18x20
47027-12	18x14
47027-13	11x15
47027-14	9,7x21
47027-15	18x20 2x
47027-16	18x20 3x



PS

**Stencil for grating pastry**  
Stampo decora crostate  
Gitterstempel  
Empreinte pour grille de pâte  
Molde tortas

art.	Ø cm.
47030-30	30



PP

**Cake marker**  
Segnaporzioni  
Tortenteiler  
Diviseur à tarte  
Marcador de tartas

art.	Ø cm.	por.
47032-10	26,5	10
47032-20	26,5	20



PP

**Cake marker, double-sided**  
Segnaporzioni, doppio  
Tortenteiler, doppelseitig  
Diviseur à tarte, double  
Marcador de tartas, doble

art.	Ø cm.	por.
47033-08	18	8-12
47033-12	26,5	12-18
47033-14	26,5	14-18



**Rolling pin, non-stick coated**  
Rullo antiaderente  
Rollwalze mit Antihftbeschichtung  
Rouleau avec revêtement anti-adhésif  
Rodillo amasador anti-adherente

art.	Ø cm.	l. cm.
47035-40	5,5	20
47035-48	6,5	25



W

**Rolling pin**  
Rullo  
Rollwalze  
Rouleau  
Rodillo amasador

art.	Ø cm.	l. cm.
47036-30	9	30
47036-35	9	35
47036-40	9	40
47036-45	9	45
47036-50	9	50
47036-60	9	60



W

**Rolling pin**  
Rullo  
Rollwalze  
Rouleau  
Rodillo amasador

art.	Ø cm.	l. cm.
47038-50	9	50
47038-60	7	60



PE

**Rolling pin**  
Rullo  
Rollwalze  
Rouleau  
Rodillo amasador

art.	Ø cm.	l. cm.
47037-30	8,0	30
47037-40	7,5	40



PE

**Rolling pin**  
Rullo  
Rollwalze  
Rouleau  
Rodillo amasador

art.	Ø cm.	l. cm.
47034-23	2,5	23
47034-51	5,0	50



W

**Rolling pin**  
Rullo  
Rollwalze  
Rouleau  
Rodillo amasador

art.	Ø cm.	l. cm.
47034-52	5	50



SS

**Rolling pin**  
Rullo  
Rollwalze  
Rouleau  
Rodillo amasador

art.	Ø cm.	l. cm.
47034-50	5	50





PE

**Rolling dough cutter**

Rullo tagliapasta  
Rollholzer  
Rouleau coupe-bandes  
Rodillo cortador

art.	l. cm.	cut mm.
47039-05	19	5
47039-10	19	10



PE

**Rolling dough cutter**

Rullo tagliapasta  
Rollholzer  
Rouleau coupe-bandes  
Rodillo cortador

art.	l. cm.	cut mm.
47039-15	19	15



**Pastry brush non-stick coated bristles**

Pennello setole antiaderenti  
Pinsetl, antihafbeschichtete Borsten  
Pinceau poils anti-adhérentes  
Pincel cerdas antiadherentes

art.	cm.	U. Pack
47640-25	2,5	1
47640-35	3,5	1

**Nylon bristles. Heat resistant up to +150°C.**  
Setole nylon. Resistente al calore fino a +150°C.



**Pastry brush**

Pennello per alimenti  
Kuchenpinsel  
Pinceaux à pâtissier  
Pincel de cocina

art.	cm.	U. Pack
47642-30	3	6
47642-40	4	6
47642-50	5	6
47642-60	6	6
47642-70	7	6

**Plastic handle, stainless steel ferrule.**  
Manico plastica, ghiera inox.



**Pastry brush**

Pennello per alimenti  
Kuchenpinsel  
Pinceaux à pâtissier  
Pincel de cocina

art.	cm.	U. Pack
47643-30	3	6
47643-40	4	6
47643-50	5	6
47643-60	6	6
47643-70	7	6

**Plastic handle, stainless steel ferrule.**  
Manico plastica, ghiera inox.



**Pastry brush**

Pennello per alimenti  
Kuchenpinsel  
Pinceaux à pâtissier  
Pincel de cocina

art.	Ø cm.	U. Pack
47644-15	1,5	6

**Plastic handle and ferrule.**  
Manico e ghiera plastica.

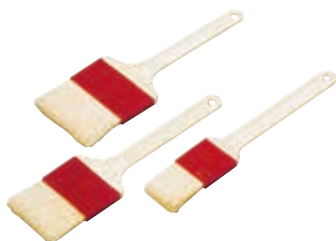

PA

**Pastry brush**

Pennello per alimenti  
Kuchenpinsel  
Pinceaux à pâtissier  
Pincel de cocina

art.	cm.	U. Pack
47645-40	4	6
47645-60	6	6
47645-75	7,5	6

**Natural bristles. – Setole naturali.**



PA

**Pastry brush**

Pennello per alimenti  
Kuchenpinsel  
Pinceaux à pâtissier  
Pincel de cocina

art.	cm.	U. Pack
47646-40	4	6
47646-60	6	6
47646-75	7,5	6

**Polyester bristles. – Setole in poliestere.**



PP

**Set 10 dough scrapers**

Set 10 raschietti  
Teigschaber, 10 Stk.  
Set 10 raclettes  
Conjunto 10 rasquetas

art.	dim. mm.
47621-01	216x128



PP

**Set 10 dough scrapers**

Set 10 raschietti  
Teigschaber, 10 Stk.  
Set 10 raclettes  
Conjunto 10 rasquetas

art.	dim. mm.
47621-02	120x86



PP

**Set 10 dough scrapers**

Set 10 raschietti  
Teigschaber, 10 Stk.  
Set 10 raclettes  
Conjunto 10 rasquetas

art.	dim. mm.
47621-03	120x88



PP

**Set 10 dough scrapers**

Set 10 raschietti  
Teigschaber, 10 Stk.  
Set 10 raclettes  
Conjunto 10 rasquetas

art.	dim. mm.
47621-04	121x81



PP

**Set 10 dough scrapers**

Set 10 raschietti  
Teigschaber, 10 Stk.  
Set 10 raclettes  
Conjunto 10 rasquetas

art.	dim. mm.
47621-05	148x99



PP

**Set 10 decorating combs**

Set 10 pettini decoratori  
Dekorationskamm, 10 Stk  
Set 10 peignes à decor  
Conjunto 10 peines decoradores

art.	dim. mm.
47621-06	145x99



PP

**Set 10 decorating combs**

Set 10 pettini decoratori  
Dekorationskamm, 10 Stk  
Set 10 peignes à decor  
Conjunto 10 peines decoradores

art.	dim. mm.
47621-07	110x80



PP

**Set 10 decorating combs**

Set 10 pettini decoratori  
Dekorationskamm, 10 Stk  
Set 10 peignes à decor  
Conjunto 10 peines decoradores

art.	dim. mm.
47621-08	216x128



SS

**Set 3 decorating combs**

Set 3 pettini decoratori  
Dekorationskamm, 3 Stk  
Set 3 peignes à decor  
Conjunto 3 peines decoradores

art.	dim. mm.
47625-03	100x100



SS

**Sugar dredger**

Spargi zucchero  
Zuckerstreuer  
Glacière à sucre  
Dosificador para azúcar

art.	Ø cm.	h. cm.
47022-12	7	9



PP

**Moisture bottle**

Flacone per bagne  
Sprühflasche  
Bouteille à puncher  
Frasco nebulizador

art.	dim. cm.	lt.
47679-10	10x5,6x27,5	1



NEW

PP

**Spraying bottle**

Flacone nebulizzatore  
Sprühflasche  
Bouteille à puncher spray  
Frasco nebulizador

art.	dim. cm.	lt.
47679-11	7x7x30	1



SS

**Flour sifter**

Setaccio farina  
Einhand-Drücksieb  
Tamiseur farine  
Tamiz para harina

art.	Ø cm.	gr.
42607-05	12	500



**Icing sugar sieve**

Setaccio per zucchero a velo  
Sieb für Puderzucker  
Tamis à sucre glace  
Cedazo para azúcar glas

art.	Ø cm.	h. cm.
47614-25	25,5	7



**Sieve for flour**

Setaccio rete farina  
Sieb für Mehl  
Tamis pour farine  
Cedazo para harina

art.	Ø cm.	h. cm.
47615-25	25,5	7



**Flour brush**

Spazzola per farina  
Mehlbürste  
Brosse à pétrin  
Cepillo para harina

art.	cm.
42614-21	30

Horse hair. – Setole di cavallo.

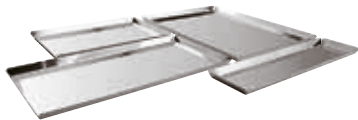

NEW

SS

Vassoio espositore  
Auslegeplatte  
Plat patissier  
Bandeja pastelería

art.	dim. cm.
47074-01	30x20x1,5
47074-02	40x10x1,5
47074-03	40x20x1,5
47074-04	40x30x1,5



NEW

SS

Vassoio espositore  
Auslegeplatte  
Plat patissier  
Bandeja pastelería

art.	dim. cm.
47074-05	50x10x1,5
47074-06	60x6x1,5
47074-07	60x10x1,5
47074-08	60x20x1,5



SS

**Display tray**  
Vassoio espositore  
Auslegeplatte  
Plat patissier  
Bandeja pastelería

art.	dim. cm.
47075-20	20x16x1
47075-30	30x21x1
47075-45	45x34x1



SS

**Display tray**  
Vassoio espositore  
Auslegeplatte  
Plat patissier  
Bandeja pastelería

art.	dim. cm.
42533-23	23x16,5x0,5
42533-26	26x19,5x0,5
42533-31	31x24x0,5
42533-36	36x28,5x0,5
42533-40	40x32,5x0,5



**Display tray, aluminum**  
Vassoio espositore, alluminio  
Auslegeplatte, Aluminium  
Plat patissier, alu  
Bandeja pastelería, aluminio

art.	dim. cm.
47070-37	37,5x24,5x1
47070-48	48x31x1
47070-60	60x40x1



**Baking paper, siliconized**  
Carta da forno siliconata  
Bactrennfolie, silikonisiert  
Feuille de cuisson, siliconée  
Papel de horno siliconado

art.	dim. cm.	pcs/pz
47682-53	53x32,5	500
47682-60	60x40	500

**Artificial parchment, bleached, g/m<sup>2</sup>: 41,0, both sides siliconized, reusable, for all kinds of dough.**  
Pergamena artificiale, sbiancata, g/m<sup>2</sup>: 41,0, siliconata fronte/retro, riutilizzabile, idonea per tutti i tipi di pasta.



**Baking paper, PTFE coated**  
Carta da forno, rivestimento PTFE  
Bactrennfolie, PTFE-beschichtet  
Feuille de cuisson, revêtement PTFE  
Papel de horno anti-adherente

art.	dim. cm.	U. Pack
47681-60	60x40	10

**Fiberglass tissue coated on both sides, can be used up to 500 times, tear-proof. Carefully dry after use.** – Tessuto fibra di vetro rivestito fronte/retro, resistente alla trazione, antiaderente, riutilizzabile più di 500 volte. Asciugare dopo l'uso.



**Baking sheet, silicone, microperforated**  
Tappeto silicone microforato  
Silikonbackmatte, microperforiert  
Tapis cuisson en silicone, microperforé  
Tapete de cocción silicona, microperforado

art.	GN	dim. cm.
47691-53	1/1	53x32,5
47691-64	-	60x40



**Baking sheet, silicone**  
Tappeto silicone  
Silikonbackmatte  
Tapis cuisson en silicone  
Tapete de cocción silicona

art.	GN	dim. cm.
47689-53	1/1	53x32,5
47689-60	-	60x40

SILPAT – SILPAIN – ROUL’PAT



**SILPAT:** Non-stick sheet ideal for backing brioche and buns as well as any kind of sweet bread backed in sheets. Ideal also for working sugar. **SILPAIN:** Non-stick perforated sheet ideal for baking bread and tarts. **ROUL’PAT:** The silicone coating on both sides prevents the sheet from slipping. Perfect to prepare any type of dough and it also enables to easily prepare macaroon.

SILPAT: Antiaderente ideale per la cottura di tutte le viennoiseries e tutti i tipi di pasticceria da panetteria cotti in teglie. Ideale anche per la lavorazione dello zucchero. SILPAIN: Antiaderente areato ideale per la cottura di pani e la cottura in bianco di fondi per crostate. ROUL’PAT: Con il rivestimento in silicone su entrambi i lati, non scivola sul piano di lavoro. Permette di lavorare ogni tipo di pasta, e con grande facilità anche il croccante.



**SILPAT Silicone baking sheet**

Tappeto silicone  
Silikonbackmatte  
Tapis cuisson en silicone  
Tapete de cocción silicona

art.	GN	dim. cm.
47680-40	-	40x30
47680-53	1/1	53x32,5
47680-60	-	60x40



**SILPAIN Silicone baking sheet**

Tappeto silicone  
Silikonbackmatte  
Tapis de cuisson en silicone  
Tapete de cocción silicona

art.	GN	dim. cm.
47685-53	1/1	53x32,5
47685-60	-	60x40



**ROUL’PAT Silicone baking sheet**

Tappeto silicone  
Silikonbackmatte  
Tapis de cuisson en silicone  
Tapete de cocción silicona

art.	dim. cm.
47688-60	60x40



DEMARLE

**Baking tray, aluminum, silicone coated**

Teglia, alluminio silconato  
Alu-Backblech, Silikonbeschichtet  
Plaque alu, revêtement silicone  
Placa aluminio silconada

art.	GN	dim. cm.
41743D32	1/1	53x32,5
41743D53	-	53x65
41743D60	-	40x60

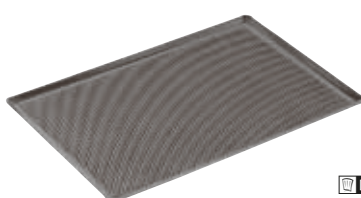

DEMARLE

**Baking tray, perforated aluminum, silicone coated**

Teglia, alluminio silconato, forato  
Alu-Backblech, gelocht, Silikonbeschichtet  
Plaque alu perforée, revêtement silicone  
Placa aluminio perforada silconada

art.	GN	dim. cm.
41753D30	-	30x40
41753D32	1/1	53x32,5
41753D53	-	53x65
41753D60	-	40x60



**Baking beans, ceramic**

Noccioli di cottura, ceramica  
Backkerne, Keramik  
Noyaux de cuisson, céramique  
Núcleos de cocción, cerámica

art.	Kg.
47011-01	1



**Acetate sheets**

Acetato in fogli  
Acetat Band-Blätter  
Feuilles en acétate  
Hojas de acetato

art.	my	dim. cm.	pcs/pz
47131-30	90	30x30	50
47131-60	90	60x40	50

**Ribbons and sheets to coat molds, to make and unmold single portions and mignons. Non-stick for food use. Suitable for cooling in blast chiller, freezer and fridge, not suitable for cooking. Extra transparent, super resistant.**



**PVC ribbon**

Nastro PVC  
PVC Band  
Ruban pâtissier en PVC  
Cinta PVC

art.	my	h. cm.	mt.
47130-25	90	2,5	305
47130-30	90	3,0	305
47130-35	90	3,5	305
47130-40	90	4,0	305
47130-45	90	4,5	305
47130-50	90	5,0	305
47130-55	90	5,5	305
47130-60	90	6,0	305

**Nastri e fogli per rivestire stampi, per realizzare e sfornare monoporzioni e mignon. Antiaderenti per uso alimentare. Adatti al raffreddamento in abbattitore, congelatore e frigo, non adatti alla cottura. Extra trasparenti, super resistenti**



SS

**Tart ring**

Anello per torte  
Tortenring  
Cercle à tarte  
Anillo para tartas

art.	Ø cm.	h. cm.
47533-07	7	2
47533-08	8	2
47533-09	9	2
47533-10	10	2
47533-12	12	2
47533-14	14	2
47533-16	16	2
47533-18	18	2
47533-20	20	2
47533-22	22	2
47533-24	24	2
47533-26	26	2
47533-28	28	2
47533-30	30	2
47533-32	32	2



SS

**Tart ring**

Anello per torte  
Tortenring  
Cercle à tarte  
Anillo para tartas

art.	Ø cm.	h. cm.
47530-14	14	3,5
47530-16	16	3,5
47530-18	18	3,5
47530-20	20	3,5
47530-22	22	3,5
47530-24	24	3,5
47530-26	26	3,5
47530-28	28	3,5
47530-30	30	3,5



SS

**Mousse ring**

Anello per mousse  
Schaumspeisenring  
Cercle à mousse  
Anillo para mousse

art.	Ø cm.	h. cm.
47532-06	6,0	4,0
47532-07	7,5	4,0
47532-08	8,0	4,5
47532-12	12,0	4,5
47532-14	14,0	4,5
47532-16	16,0	4,5
47532-18	18,0	4,5
47532-20	20,0	4,5
47532-22	22,0	4,5
47532-24	24,0	4,5
47532-26	26,0	4,5



SS

**Ice cream cake ring**

Anello per torte gelato  
Eistortenring  
Cercle à vacherin  
Circulo alto

art.	Ø cm.	h. cm.
47534-07	7	9
47534-08	9	9
47534-09	7	11
47534-10	9	11







SS

**Ice cream cake ring**  
Anello per torte gelato  
Eistortenring  
Cercle à vacherin  
Circulo alto

art.	Ø cm.	h. cm.
47534-00	8	6
47534-01	10	6



SS

**Ice cream cake ring**  
Anello per torte gelato  
Eistortenring  
Cercle à vacherin  
Circulo alto

art.	Ø cm.	h. cm.
47534-06	6	6
47534-16	16	6
47534-18	18	6
47534-20	20	6
47534-22	22	6
47534-24	24	6
47534-26	26	6
47534-28	28	6



SS

**Cake setting ring, flexible**  
Anello regolabile, flessibile  
Tortenring, verstellbar, flexible  
Cercle à tarte réglable, flexible  
Anillo ajustable, flexible

art.	Ø cm.	h. cm.
47529-07	16,5>32	7



SS

**Extensible frame**  
Telaio regolabile  
Backrahm, verstellbar  
Bande à tarte réglable  
Marco para tarta, ajustable

art.	Ø cm.	h. cm.
47526-05	30x30>57x56	5



SS

**Extensible frame**  
Telaio regolabile  
Backrahm, verstellbar  
Bande à tarte réglable  
Marco para tarta, ajustable

art.	Ø cm.	h. cm.
47528-05	19x28>34x54	5



SS

**Extensible heart frame**  
Telaio cuore regolabile  
Herz-Backrahm, verstellbar  
Bande à tarte réglable  
Marco para tarta, ajustable

art.	Ø cm.	h. cm.
47542-00	14,5>26,5	5

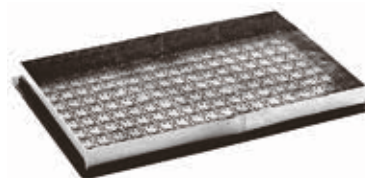

SS

**Rectangle**  
Rettangolo  
Rechteck  
Rectangle  
Rectangular

art.	dim. cm.
47527-55	55x35,5x4,5



SS

**Rectangle**  
Rettangolo  
Rechteck  
Rectangle  
Rectangular

art.	dim. cm.
47546-18	18x36x5
47546-30	30x40x5
47546-40	40x60x5

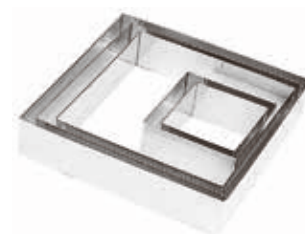

SS

**Square**  
Quadrato  
Viereck  
Carré  
Cuadrado

art.	dim. cm.
47548-02	10x10x4,5
47548-03	18x18x4,5
47548-04	20x20x4,5
47548-05	22x22x4,5





SS

**Rounded square**

Quadrato bombato  
Viereck, konvex  
Carré arrondi  
Cuadrado abombado

art.	dim. cm.
47541-02	10x10x4,5
47541-03	18x18x4,5
47541-04	20x20x4,5



SS

**Oval**

Ovale  
Ovale  
Oval  
Ovale  
Oval

art.	dim. cm.
47547-22	24,5x20x4
47547-26	30x23x4
47547-30	33x26,5x4



SS

**Comma**

Virgola  
Komma  
Virgule  
Coma

art.	Ø cm.	h. cm.
47544-20	20	4
47544-25	25	4
47544-30	30	4



SS

**Heart**

Cuore  
Herz  
Coeur  
Corazón

art.	Ø cm.	h. cm.
47542-18	18	4
47542-20	20	4
47542-22	22	4
47542-24	24	4
47542-26	26	4



SS

**Triangle**

Triangolo  
Triangolo  
Dreieck  
Dreieck  
Triangle  
Triángulo

art.	Ø cm.	h. cm.
47540-02	12	4,5
47540-03	20	4,5
47540-04	22	4,5
47540-05	24	4,5



SS

**Triangle**

Triangolo  
Triangolo  
Dreieck  
Dreieck  
Triangle  
Triángulo

art.	Ø cm.	h. cm.
47538-20	20	4
47538-23	23	4
47538-26	26	4



SS

**Rectangle**

Rettangolo  
Rechteck  
Rechteck  
Rectangle  
Rectangular

art.	dim. cm.
47546-21	25x9x2
47546-22	30x9,1x2
47546-23	35x9,2x2



SS

**Rectangle**

Rettangolo  
Rechteck  
Rechteck  
Rectangle  
Rectangular

art.	dim. cm.
47546-41	25x9x4
47546-42	30x9,1x4
47546-43	35x9,2x4

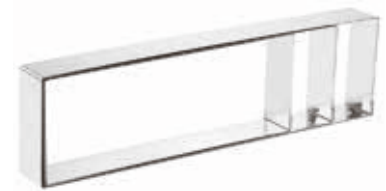

SS

**Rectangle**

Rettangolo  
Rechteck  
Rechteck  
Rectangle  
Rectangular

art.	dim. cm.
47546-51	25x9x5
47546-52	30x9,1x5
47546-53	35x9,2x5

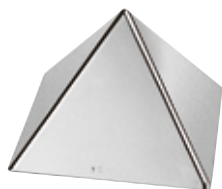

SS

**Pyramid**  
Piramide  
Pyramide  
Piramide  
Pirâmide

art.	Ø cm.	h. cm.
47535-09	9	6
47535-12	12	8
47535-15	15	10
47535-17	17	12
47535-19	19	13

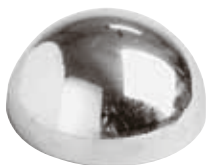

SS

**Half sphere**  
Semi-sfera  
Halbkugel  
Demi-sphère  
Semiesfera

art.	Ø cm.	h. cm.
47536-12	12	6
47536-14	14	7
47536-16	16	8
47536-18	18	9
47536-20	20	10



SS

**Crème caramel**  
Crème caramel  
Crème caramel  
Crème caramel  
Molde para flan

art.	Ø cm.	h. cm.	ml.
41660-10	7	5	150
41660-15	7	6	180

**MICROPERFORATED CAKE RINGS**  
FASCE MICROFORATE

SS



The micro-holes allow to support the edges of the cake avoiding to collapse during cooking. They also allow to expel the moisture from the dough, obtaining a perfect and always crispy cooking.

I microfori permettono di sostenere i bordi della torta evitandone il collasso in cottura. Consentono inoltre di espellere l'umidità, ottenendo una cottura sempre perfetta e croccante.



**Cake ring, microperforated**  
Fascia microforata  
Tarte-Rahmen perforiert  
Cercle microperforé  
Anillo tarta microperforado

art.	Ø cm.	h. cm.
47510-07	7	3,5
47510-09	9	3,5
47510-11	11	3,5
47510-13	13	3,5
47510-15	15	3,5
47510-17	17	3,5
47510-19	19	3,5
47510-21	21	3,5
47510-23	23	3,5
47510-25	25	3,5
47510-27	27	3,5
47510-29	29	3,5
47510-31	31	3,5



**Cake ring, microperforated**  
Fascia microforata  
Tarte-Rahmen perforiert  
Cercle microperforé  
Anillo tarta microperforado

art.	Ø cm.	h. cm.
47511-07	7	2
47511-09	9	2
47511-11	11	2
47511-13	13	2
47511-15	15	2
47511-17	17	2
47511-19	19	2
47511-21	21	2
47511-23	23	2
47511-25	25	2
47511-27	27	2
47511-29	29	2
47511-31	31	2



**Cake ring, microperforated**  
Fascia microforata  
Tarte-Rahmen perforiert  
Cercle microperforé  
Anillo tarta microperforado

art.	dim. cm.	h. cm.
47512-07	7x7	3,5
47512-09	9x9	3,5
47512-11	11x11	3,5
47512-13	13x13	3,5
47512-15	15x15	3,5
47512-17	17x17	3,5
47512-19	19x19	3,5
47512-21	21x21	3,5
47512-23	23x23	3,5
47512-25	25x25	3,5
47512-27	27x27	3,5
47512-29	29x29	3,5
47512-31	31x31	3,5



**Piepan, aluminum**  
Tortiera, alluminio  
Tortenform, Aluminium  
Tourtière, alu  
Molde, aluminio

art.	Ø cm.	h. cm.
16940-28	28	5,0
16940-32	32	5,5
16940-36	36	6,0
16940-40	40	6,5



**Savarin tin, aluminum**  
Ciambella, alluminio  
Savarinform, Aluminium  
Moule à savarin, alu  
Molde para savarin, aluminio

art.	Ø cm.	h. cm.	U. Pack
47060-06	6,0	2,5	3
47060-07	7,5	3,0	3
47060-09	9,0	3,5	3
47060-10	10,0	3,5	3
47060-12	12,0	5,5	3
47060-14	14,0	5,5	3
47060-16	16,0	5,5	3
47060-18	18,0	6,5	3
47060-20	20,0	6,5	3
47060-22	22,0	6,5	3
47060-24	24,0	8,5	3
47060-26	26,0	8,5	3
47060-30	30,0	8,5	3



**Pandoro mold, aluminum**  
Stampo pandoro, alluminio  
Pandoro-Form, Aluminium  
Moule à pandoro, aluminium  
Molde pandoro, aluminio

art.	gr.
47063-01	100
47063-02	250
47063-05	500
47063-07	750
47063-10	1000



**Gugelhupf, aluminum**  
Stampo americano, alluminio  
Gugelhupfform, Aluminium  
Moule à gugelhupf, alu  
Molde gugelhupf, aluminio

art.	Ø cm.	h. cm.
47062-18	18	10,5
47062-20	20	11,0
47062-22	22	12,0



**Plumcake, aluminum**  
Plumcake, alluminio  
Plumcake, Aluminium  
Plumcake, alu  
Molde para plumcake, aluminio

art.	dim. cm.
47064-18	18x80x6
47064-22	22x90x7
47064-26	26x10x8
47064-30	30x11x9



**Beaker shaped tin, aluminum**  
Stampo per babà, alluminio  
Timbalforn, Aluminium  
Moule à dariole, alu  
Molde, aluminio

art.	Ø cm.	h. cm.	U. Pack
47066-03	3	3,5	10
47066-04	4	4,5	10
47066-05	5	5,5	10
47066-06	6	6,0	10
47066-07	7	7,0	10
47066-08	8	8,0	10



**Crème caramel, aluminum**  
Crème caramel, alluminio  
Crème caramel, Aluminium  
Crème caramel, alu  
Molde crème caramel, aluminio

art.	Ø cm.	h. cm.	U. Pack
41659-06	6	4,8	6
41659-07	7	5,0	6
41659-08	8	5,3	6



**Cassata mold, aluminum**  
Stampo cassata, alluminio  
Cassataform, Aluminium  
Moule à cassata, alu  
Molde para cassata, aluminio

art.	Ø cm.	h. cm.
47068-12	12	10
47068-15	15	12



**Zuccotto mold, aluminum**  
Stampo per zuccotto, alluminio  
Zuccottoform, Aluminium  
Moule à zuccotto, alu  
Molde para zuccotto, aluminio

art.	Ø cm.
47069-10	10
47069-12	12
47069-14	14
47069-16	16
47069-18	18
47069-20	20

# NON STICK CAKE MOLDS TORTIERE ANTIADERENTI

PASTRY  
PASTICCERIA



Wash the mold before the first use. Slightly grease inside surface with oil, butter or margarine before baking. Allow cake to cool down a little before removing from the mold. For the cleaning, hand-wash with dish soap and dry the mold immediately after washing. Use only in traditional ovens (no microwave). Do not use sharp objects or others metal tools which could damage the pan surface. Do not use on a flame or other direct heat source, including stove tops. Do not exceed 230°C. Non-stick coating PFOA free.

Lavare lo stampo prima di utilizzarlo la prima volta. Ungere leggermente l'interno con olio, burro o margarina prima di infornare. Prima di sfornare, lasciare raffreddare per qualche minuto. Lavare a mano con detersivi liquidi ed asciugare lo stampo immediatamente dopo. Utilizzare esclusivamente in forni tradizionali (no microonde). Non utilizzare oggetti appuntiti, polveri abrasive o pagliette metalliche che possano rigare la superficie degli stampi. Evitare il contatto con fonti di calore dirette o fiamma libera. Non superare la temperatura massima di 230°C. Rivestimento antiaderente privo di PFOA.



**Pine mold**

Tortiera pino  
Tannenbaumform  
Tourtière pin  
Molde pino

art.	dim. cm.
47005-24	17x24x8,5



**Star mold**

Tortiera stella  
Sternform  
Tourtière étoile  
Molde estrella

art.	dim. cm.
47006-25	25x25x4,5



**Heart pan**

Stampo cuore  
Herz-Backblech  
Plaque coeur  
Molde corazón

art.	dim. cm.
47751-23	23x24,5x4,5

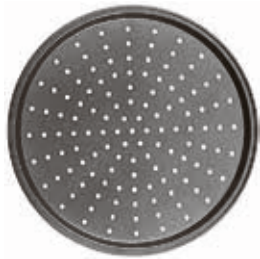

**Crispy tart pan**

Tortiera forata  
Tortenform, gelocht  
Tourtière perforée  
Molde perforado

art.	Ø cm.	h. cm.
41729-30	30	1,3
41729-34	34	1,3



**Round cake tin**

Tortiera tonda  
Tortenform, rund  
Tourtière ronde  
Molde redondo

art.	Ø cm.	h. cm.	U. Pack
47739-12	12	2,1	6
47739-24	24	2,3	1
47739-28	28	2,3	1
47739-32	32	2,5	1



**Round cake tin**

Tortiera tonda  
Tortenform, rund  
Manqué rond uni  
Molde redondo

art.	Ø cm.	h. cm.
47710-12	12	3,0
47710-16	16	4,0
47710-20	20	4,5
47710-24	24	5,0
47710-28	28	5,0
47710-32	32	5,5



**Round mold, fluted edges**

Tortiera festonata  
Runde Obsttortenform  
Tourtière ronde bord cannelé  
Molde rizado

art.	Ø cm.	h. cm.
47709-20	20	2,5
47709-24	24	2,5
47709-28	28	2,5
47709-32	32	2,5



**Round mold, fluted, loose bottom**

Tortiera festonata, fondo mobile  
Tortenform, gewellter Rand, Heheboden  
Tourtière cannelée, fond amovible  
Molde acanalado, rizado, fondo desmontable

art.	Ø cm.	h. cm.
47712-20	20	2,5
47712-24	24	2,5
47712-28	28	2,5
47712-32	32	2,5



**Savarin tin**

Ciambella  
Savarinform  
Moule pour savarin  
Molde Savarin

art.	Ø cm.	h. cm.	U. Pack
47711-08	8	2,0	6
47711-12	12	2,5	6
47711-22	22	4,5	1
47711-24	24	5,0	1
47711-26	26	6,2	1



**Trois Frères cake ring**

Tortiera trois frères  
Frankfurter Kranzform  
Tourtière trois frères

Molde trois frères

art.	Ø cm.	h. cm.	U. Pack
47713-22	22	5,5	6



**Gugelhupf cake pan**

Stampo americano  
Gugelhupfform  
Moule à gugelhupf

Molde gugelhupf

art.	Ø cm.	h. cm.
47705-22	22	10



**Loaf pan**

Tortiera rettangolare  
Königskuchenform  
Cake embouti

Molde rectangular

art.	dim. cm.
47714-26	26x9,5x7,5
47714-28	28x10x7,5



**Rectangular mold, loose plate bottom**

Tortiera, fondo mobile  
Backform, gerippt, Hebeboden  
Tourtière cannelée, fond amovible

Molde fondo desmontable

art.	dim. cm.
47717-35	35x11x2,5



**Square mold, fluted, loose bottom**

Tortiera festonata, fondo mobile  
Tortenform, gewellter Rand, Hebeboden  
Tourtière carrée, cannelée, fond amovible

Molde cuadrado, rizado, fondo desmontable

art.	dim. cm.
47738-23	23x23x2,5



**Baking mold Daisy**

Tortiera margherita  
Tortiera margherita  
Margeriten-Backform  
Moule à marguerite

Molde margarita

art.	Ø cm.	h. cm.
47718-20	20	6



**Round mold, fluted, loose bottom**

Tortiera festonata, fondo mobile  
Tortenform, gewellter Rand, Hebeboden  
Tourtière cannelée, fond amovible

Molde acanalado, fondo desmontable

art.	Ø cm.	h. cm.	U. Pack
47719-10	10	3	6
47719-24	25	5	1



**Round mold, fluted, loose bottom**

Tartelletta festonata, fondo mobile  
Runde, gewellte Tortellets, Hebeboden  
Tartelette ronde cannelée, fond amovible

Molde redondo rizado, fondo desmontable

art.	Ø cm.	h. cm.	U. Pack
47758-10	10	1,8	6
47758-12	12	2,0	6



**Charlotte mold**

Charlotte  
Charlotte-Form  
Charlotte

Molde Charlotte

art.	Ø cm.	h. cm.	U. Pack
47734-18	18	10	6



**Bavarois mold**

Bavarese  
Bayerische-Kuchenform  
Moule Bavarois  
Molde Bávaro

art.	Ø cm.	h. cm.
47735-18	18	9



**Rectangular cake mold**

Tortiera rettangolare  
Königskuchenform  
Cake évasé  
Molde ensanchado

art.	dim. cm.
47733-18	18x7,5x6,5
47733-24	24x9x7,5
47733-30	30x10x8
47733-36	36x10,5x8



**Folding loaf pan**

Tortiera rettangolare apribile  
Aufklappbare-Königskuchenform  
Cake ouvrant  
Molde rectangular desmontable

art.	dim. cm.
47715-30	30x10x7,5





**Rectangular baking sheet**

Teglia rettangolare  
Rechteckige-Backform  
Plaque rectangulaire  
Placa rectangular

art. dim. cm.  
47716-37 37x26x1,3



**Loaf pan with hinges, loose bottom**

Bacinella paté con cerniera, fondo mobile  
Springkastenform, Heheboden  
Pâté à charnière, fond démontable  
Molde con bisagra, fondo desmontable

art. dim. cm.  
47736-30 30x8x8  
47736-35 35x8x8  
47736-40 40x8x8  
47736-50 50x8x8



**Mini paté mold**

Stampo mini-paté  
Pastetenkastenform  
Mini-pâté à croûte  
Molde minipaté

art. dim. cm.  
47018-30 30x4x6  
47018-50 50x4x6



**Loaf pan**

Stampo carré  
Königskuchenform  
Cake évasé  
Molde ensanchado

art. dim. cm.  
47752-09 9x6x3,4  
47752-16 14x6,5x4  
47752-21 17x9,5x5,5



**Fluted loaf pan**

Stampo carré, fondo festonato  
Königskuchenform, gerippt  
Cake évasé, fond cannelé  
Molde ensanchado, fondo rizado

art. dim. cm.  
47753-31 31x12x5



**Baguette baking pan**

Teglia baguettes  
Baguetteform  
Plaque à baguettes  
Placa para baguettes

art. dim. cm.  
47014-35 37,5x33x2,5



**Oval aspic mold**

Aspic ovale  
Ovale Aspikform  
Aspic ovale  
Molde oval

art. dim. cm. U. Pack  
47726-07 7,5x5,5x3,8 6



**Oval aspic mold, star bottom**

Aspic ovale, fondo stella  
Ovale Aspikform, Sternboden  
Aspic ovale, étoilé  
Molde oval, fondo estrella

art. dim. cm. U. Pack  
47727-07 7,5x5,5x3,8 6



**Rum baba mold**

Stampo babà  
Runde Babaform  
Dariole embouti  
Molde para babà

art. Ø cm. h. cm. U. Pack  
47728-06 6 6 6



**Wine leaf tart mold**

Tartelletta foglia di vite  
Törtchenform Weinblatt  
Tartelette feuille vigne  
Molde pasteles

art. Ø mm. h. cm. U. Pack  
47760-12 12 2 6



**Oak leaf tart mold**

Tartelletta foglia di quercia  
Törtchenform Eichenblatt  
Tartelette feuille chêne  
Molde pasteles

art. Ø cm. h. cm. U. Pack  
47759-12 12 2 6





**Savarin mold**

Tartelletta savarin  
Savarinförmchen  
Savarin

Molde savarin

art.	Ø mm.	h. cm.	U. Pack
47757-65	6,5	1,5	6
47757-80	8,0	2,0	6



**Oval boat mold**

Tartelletta barchetta  
Schiffchenförmchen  
Barquette unie

Molde barquilla

art.	dim. cm.	U. Pack
47720-06	6x2x1	6
47720-08	8x3,3x1,2	6
47720-10	10x4,3x1,3	6
47720-12	12x5x1,3	6



**Fluted oval boat mold**

Tartelletta barchetta, festonata  
Schiffchenförmchen, gerippt  
Barquette, cannelée

Molde barquilla, rizado

art.	dim. cm.	U. Pack
47721-08	8x4x1,2	6
47721-10	10x4,5x1,2	6
47721-12	12x5x1,4	6



**Round plain mold**

Tartelletta tonda  
Backförmchen, rund  
Tartelette ronde, unie

Molde redondo

art.	Ø cm.	U. Pack
47722-05	5	6
47722-06	6	6
47722-07	7	6
47722-08	8	6
47722-10	10	6



**Round fluted mold**

Tartelletta tonda festonata  
Backförmchen, rund, gerippt  
Tartelette ronde, cannelée

Molde redondo, rizado

art.	Ø cm.	U. Pack
47723-05	5	6
47723-06	6	6
47723-07	7	6
47723-08	8	6
47723-10	10	6
47723-12	12	6



**Brioche mold**

Tartelletta a brioche  
Brioches-Förmchen  
Tartelette brioche

Molde brioche

art.	Ø cm.	U. Pack
47724-06	6	6
47724-08	8	6
47724-10	10	6
47724-11	11	6



**Friand mold**

Tartelletta rettangolare  
Friand-Förmchen  
Friand

Molde rectangular

art.	dim. cm.	U. Pack
47725-09	10x5x1,4	6



**Box of small assorted molds**

Scatola tartellette assortite  
Satz Förmchen  
Boîte petits fours, assortis  
Surtido moldes

art.	pcs/pz
47730-24	24
47730-36	36
47730-60	60



**Small mold**

Tartelletta  
Törtchenform  
Petit four

Molde pasteles

art.	dim. cm.	U. Pack
47747-03	4,5x3	6



**Small mold**

Tartelletta  
Törtchenform  
Petit four

Molde pasteles

art.	dim. cm.	U. Pack
47747-06	6x3	6



**Small mold**

Tartelletta  
Törtchenform  
Petit four

Molde pasteles

art.	Ø cm.	h. cm.	U. Pack
47747-10	4,0	1,0	6
47747-11	3,5	1,4	6



**Small mold**

Tartelletta  
Törtchenform  
Petit four

Molde pasteles

art.	Ø cm.	U. Pack
47747-01	4,5	6





**Small mold**  
Tartelletta  
Törtchenform  
Petit four  
Molde pasteles

art.	dim. cm.	U. Pack
47747-04	3,5x3,5	6



**Small mold**  
Tartelletta  
Törtchenform  
Petit four  
Molde pasteles

art.	dim. cm.	U. Pack
47747-07	6x3	6



**Small mold**  
Tartelletta  
Törtchenform  
Petit four  
Molde pasteles

art.	Ø cm.	U. Pack
47723-05	5	6



**Small mold**  
Tartelletta  
Törtchenform  
Petit four  
Molde pasteles

art.	dim. cm.	U. Pack
47747-05	4,5x2,5	6



**Small mold**  
Tartelletta  
Törtchenform  
Petit four  
Molde pasteles

art.	dim. cm.	U. Pack
47747-09	5x3	6



**Madeleine sheet**  
Stampo per madeleines  
Madeleine-Backblech  
Plaque madeleines  
Molde Madeleine

art.	dim. cm.
47731-12	26x20



**Madeleinette sheet**  
Stampo per madeleinettes  
Madeleinette-Backblech  
Plaque madeleinettes  
Molde Madeleine

art.	dim. cm.
47732-20	39,5x12,5



**Cup bun pan**  
Stampo tartellette  
Backblech  
Plaque tartelettes  
Molde pasteles

art.	Ø cm.	dim. cm.
47748-35	6,5	35,5x27x2,5



**Snowman mold**  
Stampo pupazzo di neve  
Schneemann-Backblech  
Plaque bonhomme de neige  
Molde muñeco de nieve

art.	dim. cm.
47763-31	31x19,7x5



**Snowman mold**  
Stampo pupazzo di neve  
Schneemann-Backblech  
Plaque bonhomme de neige  
Molde muñeco de nieve

art.	dim. cm.
47762-23	23x5



**Christmas style mold**  
Stampo di Natale  
Weihnachts-Backblech  
Plaque de Noël  
Molde de Noel

art.	dim. cm.
47750-06	31,5x21,5x2,5



**Santa Claus mold**  
Stampo Babbo Natale  
Weihnachtsmann-Backblech  
Plaque Père Noël  
Molde Papà Noel

art.	dim. cm.
47761-23	23x4,8



**Easter muffin pan**  
Stampo motivi pasquali  
Ostern-Backblech  
Plaque Pâque  
Molde Pascua

---

art.	dim. cm.
47749-35	35x27x3



**Egg mold**  
Stampo uovo  
Ostereierform  
Moule à oeuf  
Molde para huevos

---

art.	dim. cm.
47007-26	26x8,3



**Easter rabbit mold**  
Stampo coniglietto di Pasqua  
Osternhase-Backblech  
Plaque lapin de Pâque  
Molde conejo de Pascua

---

art.	dim. cm.
47764-12	12x2,6



**Easter rabbit mold**  
Stampo coniglio di Pasqua  
Osternhase-Backblech  
Plaque lapin de Pâque  
Molde conejo de Pascua

---

art.	dim. cm.
47764-28	28x5,4



**Springform mold with 6 bottoms**  
Stampo apribile, 6 fondi  
Springform mit 6 Böden  
Manqué démontable, 6 fonds  
Molde desmontable, 6 fondos

---

art.	Ø cm.	h. cm.
47755-26	26	6



**Springform mold**  
Stampo apribile  
Springform  
Manqué démontable  
Molde desmontable

---

art.	Ø cm.	h. cm.
47754-20	20,5	6,5
47754-24	24,0	6,5
47754-26	26,0	6,5
47754-28	28,0	6,7



**Fluted springform pan**  
Stampo ciambella apribile  
Savarinspringform  
Manqué savarin démontable  
Molde savarin desmontable

---

art.	Ø cm.	h. cm.
47756-20	20,5	4,7
47756-24	24,0	6,8
47756-26	26,0	6,5
47756-28	28,0	6,7

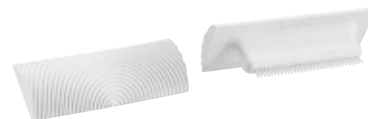

**Rubber comb, wood effect**  
Tampone finto legno  
Kamm aus Kunststoff, holzartig  
Peigne faux bois  
Peine de goma, efecto madera

---

art.	cm.
47684-15	15



**Log mold, plastic**  
Stampo per tronco, plastica  
Kastenform, Kunststoff  
Gouttière, plastique  
Molde, plástico

---

art.	dim. cm.
47659-01	48x6,5x7
47659-02	48x6,5x7
47659-03	48x6,5x7
47659-04	48x5,0x4

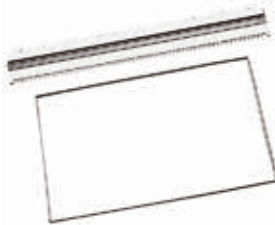

**Comb for Charlotte with frame**  
Pettine Charlotte con telaio  
Charlotte-Kamme mit Rahmen  
Peigne à Charlotte avec cadre  
Peine para Charlotte con marco

---

art.	dim. cm.
47670-02	57x36,5

SS



**Comb with 5 rubber blades**  
Pettine con 5 fasce gomma  
Kamm mit 5 Gummiklingen  
Peigne avec 5 bandes à décor  
Peine con 5 láminas de goma

---

art.	dim. cm.
47672-05	70x10

SS

**BISCUIT DECORATION FRAMES CM 60X40**  
GRIGLIE DECORO BISCUIT CM 60X40



Place the grill on silicone mat. Spread uniformly the decorating paste. Take off the grid and put into refrigerator. Afterwards spread uniformly the biscuit. Bake in the oven at 230°C for 8 minutes. Place the biscuit upside down on a greaseproof paper and remove carefully the silicone mat. By using an extensible pastry cutter cut the biscuit into stripes.

Appoggiare la griglia su un tappeto di silicone. Spatolare la pasta decoro uniformemente. Togliere la griglia e passare in congelatore. Successivamente stendere il biscuit. Cuocere in forno a 230°C per 8 minuti, appoggiare il biscuit capovolto su un foglio e togliere delicatamente il tappeto. Tagliare le fasce di biscuit nella larghezza desiderata.



S/steel frame - Griglia inox

art.

47674-01



S/steel frame - Griglia inox

art.

47674-02



S/steel frame - Griglia inox

art.

47674-03



S/steel frame - Griglia inox

art.

47674-04



S/steel frame - Griglia inox

art.

47674-05



S/steel frame - Griglia inox

art.

47674-06



S/steel frame - Griglia inox

art.

47674-07



S/steel frame - Griglia inox

art.

47674-08

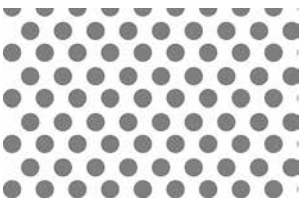

Plastic frame - Griglia plastica

art. Ø cm.

47677-01 0,7

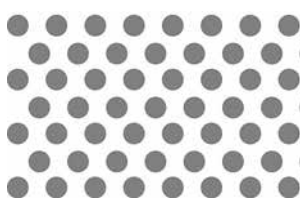

Plastic frame - Griglia plastica

art. Ø cm.

47677-02 0,9

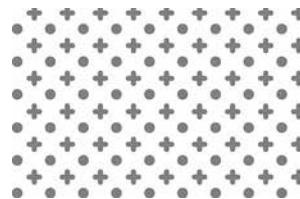

Plastic frame - Griglia plastica

art.

47677-03

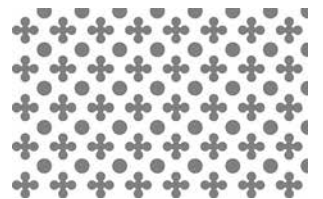

Plastic frame - Griglia plastica

art.

47677-04

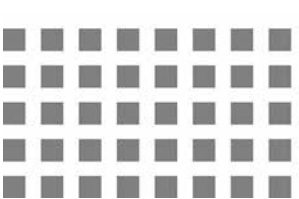

Plastic frame - Griglia plastica

art.

47677-05

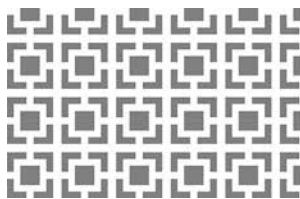

Plastic frame - Griglia plastica

art.

47677-06

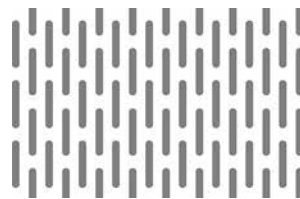

Plastic frame - Griglia plastica

art.

47677-07



Plastic frame - Griglia plastica

art.

47677-08

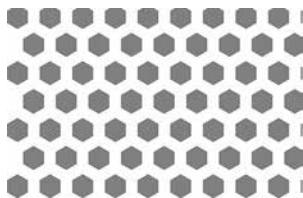

Plastic frame - Griglia plastica

art.  
47677-09



Plastic frame - Griglia plastica

art.  
47677-10

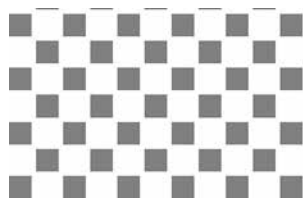

Plastic frame - Griglia plastica

art.  
47677-11



Plastic frame - Griglia plastica

art.  
47677-12

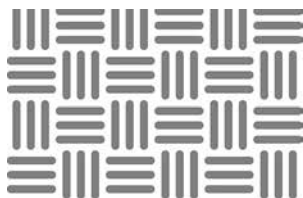

Plastic frame - Griglia plastica

art.  
47677-14



Plastic frame - Griglia plastica

art.  
47677-18

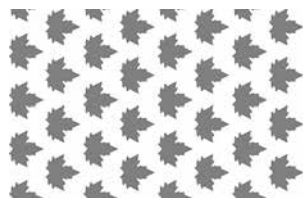

Plastic frame - Griglia plastica

art.  
47677-19

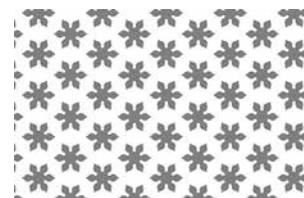

Plastic frame - Griglia plastica

art.  
47677-20



Cookie cutter frame

Placca biscotti  
Ausstechmatte  
Plaque coupe biscuits  
Rejilla corta galletas

art.	Ø cm.	dim. cm.	pcs/pz
47675-01	8,8	58x39	20



Cookie cutter frame

Placca biscotti  
Ausstechmatte  
Plaque coupe biscuits  
Rejilla corta galletas

art.	Ø cm.	dim. cm.	pcs/pz
47675-02	4,5	58x39	72

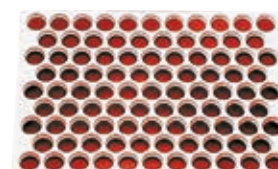

Cookie cutter frame

Placca biscotti  
Ausstechmatte  
Plaque coupe biscuits  
Rejilla corta galletas

art.	Ø cm.	dim. cm.	pcs/pz
47675-03	5,5	58x39	53

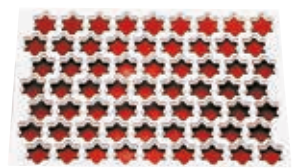

Cookie cutter frame

Placca biscotti  
Ausstechmatte  
Plaque coupe biscuits  
Rejilla corta galletas

art.	Ø cm.	dim. cm.	pcs/pz
47675-04	5,2	58x39	63

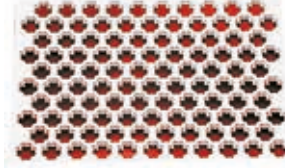

Cookie cutter frame

Placca biscotti  
Ausstechmatte  
Plaque coupe biscuits  
Rejilla corta galletas

art.	Ø cm.	dim. cm.	pcs/pz
47675-05	4,5	58x39	60

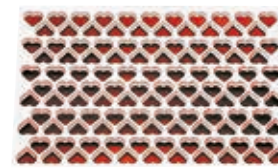

Cookie cutter frame

Placca biscotti  
Ausstechmatte  
Plaque coupe biscuits  
Rejilla corta galletas

art.	Ø cm.	dim. cm.	pcs/pz
47675-06	4	58x39	95

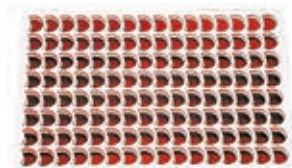

Cookie cutter frame

Placca biscotti  
Ausstechmatte  
Plaque coupe biscuits  
Rejilla corta galletas

art.	Ø cm.	dim. cm.	pcs/pz
47675-07	5	58x39	78

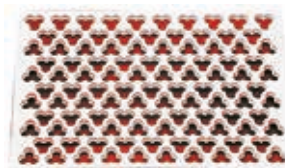

Cookie cutter frame

Placca biscotti  
Ausstechmatte  
Plaque coupe biscuits  
Rejilla corta galletas

art.	Ø cm.	dim. cm.	pcs/pz
47675-08	5	58x39	68

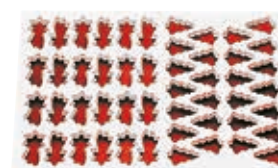

Cookie cutter frame

Placca biscotti  
Ausstechmatte  
Plaque coupe biscuits  
Rejilla corta galletas

art.	Ø cm.	dim. cm.	pcs/pz
47675-09	6-7,5	58x39	24-26



**MONOPORTION TRAY MOLDS**  
**TEGLIE MONOPORZIONI**



**Tray cm. 60x40**

Teglia  
Blech  
Plaque  
Bandeja

art.	dim. mm.	gr.	pcs/pz
47651-01	Ø 44 h 25	20	96
47651-02	55x35x25	20	96
47651-03	46x46x25	20	96
47651-04	60x38x25	20	96
47651-05	58x39x25	20	96
47651-07	38x38x25	20	96



**Extractor**

Estrattore  
Extraktor  
Extracteur  
Extractor

art.	dim. mm.
47656-01	Ø 44 h 25
47656-02	55x35x25
47656-03	46x46x25
47656-04	60x38x25
47656-05	58x39x25
47656-07	38x38x25



**Cutter**

Tagliapasta  
Ausstechform  
Coupe-pâte  
Cortador

art.	dim. mm.
47655-01	Ø 44 h 25
47655-02	55x35x25
47655-03	46x46x25
47655-04	60x38x25
47655-05	58x39x25
47655-07	38x38x25



**Tray cm. 60x40**

Teglia  
Blech  
Plaque  
Bandeja

art.	dim. mm.	gr.	pcs/pz
47652-01	Ø 67 h 40	75	35
47652-02	86x50x40	75	35
47652-03	74x71x40	75	35
47652-04	90x58x40	75	35
47652-05	88x60x40	75	35
47652-07	59x59x40	75	35



**Extractor**

Estrattore  
Extraktor  
Extracteur  
Extractor

art.	dim. mm.
47658-01	Ø 67 h 40
47658-02	86x50x40
47658-03	74x71x40
47658-04	90x58x40
47658-05	88x60x40
47658-07	59x59x40



**Cutter**

Tagliapasta  
Ausstechform  
Coupe-pâte  
Cortador

art.	dim. mm.
47657-01	Ø 67 h 40
47657-02	86x50x40
47657-03	74x71x40
47657-04	90x58x40
47657-05	88x60x40
47657-07	59x59x40

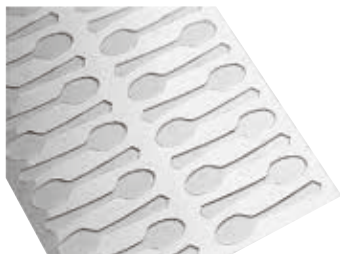

Stencil cm. 31x51

art.	dim. cm.	pcs/pz
47875-11	13x3	30



Stencil cm. 31x51

art.	dim. cm.	pcs/pz
47875-13	7,5x3,5	40



Stencil cm. 31x51

art.	dim. cm.	pcs/pz
47875-14	6,5x4	32

**PRALINE'S SILICONE MOLDS CM 19X29**  
STAMPI IN SILICONE PER PRALINE CM 19X29



Practical, flexible and resistant silicone molds for sweet or salty creations (snaks, truffles, jellies, pralines). Perfect to make large quantities in short time. They withstand from -40° to +250°C. Can be used in the oven, refrigerator and blast chiller.

Pratici stampi in silicone flessibili e resistenti per creazioni dolci o salate (snack, tartufi, gelatine, praline). Ideali per realizzare grandi quantità in poco tempo. Resistono da -40° a +250°C. Utilizzabili in forno, frigorifero e abbattitore.

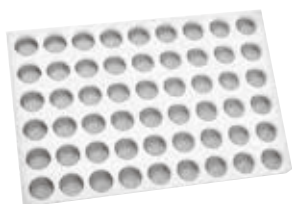

Chocoflex - psc/pz 54

art.	Ø mm.	h.
47783-01	26	14

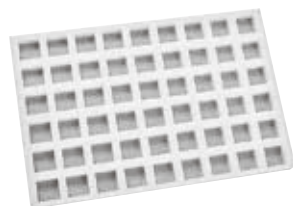

Chocoflex - psc/pz 54

art.	dim. mm.
47783-02	23x23x14

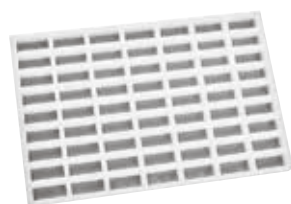

Chocoflex - psc/pz 63

art.	dim. mm.
47783-03	35x14,5x14



Chocoflex - psc/pz 49

art.	dim. mm.
47783-04	32x21x14

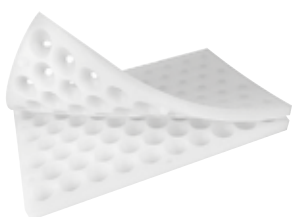

Chocoflex - psc/pz 54

art.	Ø mm.	h.
47783-11	26	14



Chocoflex - psc/pz 40

art.	Ø mm.	h.
47783-12	30-10	12



Chocoflex - psc/pz 15

art.	dim. mm.
47783-13	90x30x19



Chocoflex - psc/pz 15

art.	dim. mm.
47783-14	90x30x19

CHOCOLATE  
CIOCCOLATO

PC



Polycarbonate chocolate molds. Mold size 17,5x27,5 cm.

Stampi policarbonato. Misure stampo 17,5x27,5 cm.



NEW

Chocolate/Ciocolato Praline

art.	dim. mm.	pcs/pz
47861-02	50x25x15	21



NEW

Chocolate/Ciocolato Praline

art.	dim. mm.	pcs/pz
47861-03	30x30x8	24



NEW

Chocolate/Ciocolato Praline

art.	Ø mm.	h.	pcs/pz
47861-04	35	8	24



NEW

Chocolate/Ciocolato Praline

art.	dim. mm.	pcs/pz
47861-05	33x33x15	24



NEW

Chocolate/Ciocolato Praline

art.	dim. mm.	pcs/pz
47861-07	39x18x15,5	30
47861-08	96x22x15,5	10



NEW

Chocolate/Ciocolato Praline

art.	dim. mm.	pcs/pz
47861-09	39x18x15,5	30
47861-10	96x22x17	10



NEW

Chocolate/Ciocolato Praline

art.	dim. mm.	pcs/pz
47861-11	39x20x16	27
47861-06	96x22x17	10



NEW

Chocolate/Ciocolato Praline

art.	dim. mm.	pcs/pz
47861-12	52x26x14	21



NEW

Chocolate/Ciocolato Praline

art.	dim. mm.	pcs/pz
47861-13	42x25x6	20



NEW

Chocolate/Ciocolato Praline

art.	dim. mm.	pcs/pz
47861-14	123x27x12	8



NEW

Chocolate/Ciocolato Praline

art.	dim. mm.	pcs/pz
47861-15	138x72x11	3



Chocolate/Ciocolato Praline

art.	dim. mm.	pcs/pz
47860-17	30x30x12	24





Chocolate/Ciocolato Praline

art.	Ø mm.	h.	pcs/pz
47860-18	27	17	24



Chocolate/Ciocolato Praline

art.	Ø mm.	h.	pcs/pz
47860-21	29	18	24



Chocolate/Ciocolato Praline

art.	dim. mm.	pcs/pz
47860-24	40x42x15	15



Chocolate/Ciocolato Praline

art.	dim. mm.	pcs/pz
47860-27	27x27x13	28



Chocolate/Ciocolato Praline

art.	dim. mm.	pcs/pz
47860-31	33x25x12	24



Chocolate/Ciocolato Praline

art.	Ø mm.	h.	pcs/pz
47860-35	30	19	28



Chocolate/Ciocolato Praline

art.	dim. mm.	h.	pcs/pz
47860-36	25x25x25	25	40



Chocolate/Ciocolato Praline

art.	dim. mm.	pcs/pz
47860-37	36x22x20	36



Chocolate/Ciocolato Praline

art.	dim. mm.	pcs/pz
47860-38	48x18,5x19	16



Chocolate/Ciocolato Praline

art.	dim. mm.	pcs/pz
47860-39	30x18x15	30



Chocolate/Ciocolato Praline

art.	Ø mm.	h.	pcs/pz
47860-40	29	21	40



Chocolate/Ciocolato Praline

art.	dim. mm.	pcs/pz
47860-42	35x23x16	36



Chocolate/Ciocolato Praline

art.	dim. mm.	pcs/pz
47860-43	38x28x18	30



Chocolate/Ciocolato Praline

art.	dim. mm.	pcs/pz
47860-44	28x32x15	32



Chocolate/Ciocolato Praline

art.	dim. mm.	pcs/pz
47860-46	35x20x17	30



Chocolate/Ciocolato Praline

art.	Ø mm.	h.	pcs/pz
47860-48	28	24	40



Chocolate/Ciocolato Praline

art.	Ø mm.	h.	pcs/pz
47860-49	30	22	28



Chocolate/Ciocolato Praline

art.	Ø mm.	h.	pcs/pz
47860-50	26	15	35





Chocolate/Cioccolato Praline

art.	dim. mm.	pcs/pz
47860-53	22x22x22	28



Chocolate/Cioccolato Praline

art.	dim. mm.	pcs/pz
47860-55	26x20x21	28



Chocolate/Cioccolato Praline

art.	Ø mm.	h.	pcs/pz
47860-56	24	21	28



Chocolate/Cioccolato Praline

art.	dim. mm.	pcs/pz
47860-58	17x12x5	130



Chocolate/Cioccolato Praline

art.	Ø mm.	h.	pcs/pz
47860-60	25	18,5	28



Chocolate/Cioccolato Praline

art.	dim. mm.	pcs/pz
47860-61	30x20x17,5	28



Chocolate/Cioccolato Praline

art.	Ø mm.	h.	pcs/pz
47860-62	27	20	30



Chocolate/Cioccolato Praline

art.	Ø mm.	h.	pcs/pz
47860-63	27	20	30



Chocolate/Cioccolato Praline

art.	dim. mm.	pcs/pz
47860-66	25x25x15	30



Chocolate/Cioccolato Praline

art.	dim. mm.	pcs/pz
47860-67	25x25x15	30



Chocolate/Cioccolato Praline

art.	Ø mm.	h.	pcs/pz
47860-68	28	25	40



Chocolate/Cioccolato Praline

art.	dim. mm.	pcs/pz
47860-69	40x20x18	30



Chocolate/Cioccolato Praline

art.	dim. mm.	pcs/pz
47860-70	40x18x15	30



Chocolate/Cioccolato Praline

art.	dim. mm.	pcs/pz
47860-71	26x26x20	30



Chocolate/Cioccolato Praline

art.	dim. mm.	pcs/pz
47860-73	31x22x22	5x6



Chocolate/Cioccolato Praline

art.	dim. mm.	pcs/pz
47860-74	32x32x4	24





Chocolate/Ciocolato Praline

art.	dim. mm.	pcs/pz
47860-75	20x20x16	28



Chocolate/Ciocolato Praline

art.	dim. mm.	pcs/pz
47860-81	30x18x15	30



Chocolate/Ciocolato Praline

art.	dim. mm.	pcs/pz
47860-83	30x30x15	24



Chocolate/Ciocolato Praline

art.	Ø mm.	h.	pcs/pz
47860-84	26	19	35



Chocolate/Ciocolato Praline

art.	dim. mm.	pcs/pz
47860-85	35x22x16	35



Chocolate/Ciocolato Praline

art.	dim. mm.	pcs/pz
47860-95	25x25x13	24



Chocolate/Ciocolato Praline

art.	Ø mm.	h.	pcs/pz
47860-96	35	15	24



Chocolate/Ciocolato Praline

art.	dim. mm.	pcs/pz
47862-31	28x28x16	28



Chocolate/Ciocolato Praline

art.	dim. mm.	pcs/pz
47862-32	24x24x18	28



Chocolate/Ciocolato Praline

art.	dim. mm.	pcs/pz
47862-33	40x42x16	15



Chocolate/Ciocolato Praline

art.	dim. mm.	pcs/pz
47862-34	41x24x20	20



Chocolate/Ciocolato Praline

art.	dim. mm.	pcs/pz
47862-35	30x30x11	28



Chocolate/Ciocolato Praline

art.	dim. mm.	pcs/pz
47862-36	35x23x17	24



Chocolate/Ciocolato Bars

art.	dim. mm.	pcs/pz
47862-38	50x26x3	16



Chocolate/Ciocolato Bars

art.	dim. mm.	pcs/pz
47862-39	74x33x5	12



**MINI CHOCO FILL**

PC



Polycarbonate molds mm. 275x175. To create small mignon and refined pralines with an original and inviting look.

Stampi in polycarbonato mm. 275x175 . Per creare piccoli mignon e raffinate praline dall'aspetto originale e invitante.



**NEW**

Mini choco fill

art.	Ø mm.	h.	pcs/pz
47862-64	27	31	28



**NEW**

Mini choco fill

art.	Ø mm.	h.	pcs/pz
47862-65	37	14	15



**NEW**

Mini choco fill

art.	dim. mm.	pcs/pz
47862-66	27x27x31	28



**NEW**

Mini choco fill

art.	dim. mm.	pcs/pz
47862-67	33x33x14	24



Mini choco fill

art.	dim. mm.	pcs/pz
47862-03	32x24x29	24



Mini choco fill

art.	dim. mm.	pcs/pz
47862-04	44x56x39	12



Mini choco fill

art.	Ø mm.	h.	pcs/pz
47862-05	40	17	15





Mini choco fill

art.	dim. mm.	pcs/pz
47862-06	33x31x20	24



Mini choco fill

art.	dim. mm.	pcs/pz
47862-07	33x33x23	24



Mini choco fill

art.	dim. mm.	pcs/pz
47862-08	44x55x23	12



Mini choco fill

art.	Ø mm.	h.	pcs/pz
47862-09	40	18,5	15



Mini choco fill

art.	Ø mm.	h.	pcs/pz
47862-10	32	37	20



Tray/Vassoio

art.	dim. cm.	pcs/pz
47862C10	38x10x2,5	20



Chocolate/Ciocolato Decoration

art.	dim. mm.	gr.	pcs/pz
47862-70	64x26	2/3	16



Chocolate/Ciocolato Decoration

art.	dim. mm.	gr.	pcs/pz
47862-71	47x39	2/3	15



Chocolate/Ciocolato Decoration

art.	dim. mm.	gr.	pcs/pz
47862-72	110x7	3/4	22



Chocolate/Ciocolato Decoration

art.	dim. mm.	gr.	pcs/pz
47862-73	66x21	2/3	18



Chocolate/Ciocolato Decoration

art.	dim. mm.	gr.	pcs/pz
47862-74	65x22	2/3	18



Chocolate/Ciocolato Decoration

art.	dim. mm.	gr.	pcs/pz
47862-75	71x71	2/3	18



Chocolate/Ciocolato Decoration

art.	Ø mm.	gr.	pcs/pz
47862-76	51>73	2/3	18



Chocolate/Ciocolato Decoration

art.	dim. mm.	gr.	pcs/pz
47862-77	68x81	2/3	18





Letters & Numbers

art. h. cm.  
47860-86 3

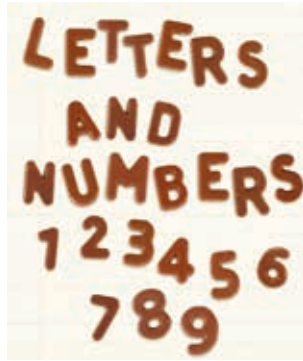

**NEW**



Spheres/Sfere

art.	Ø mm.	pcs/pz
47861-16	20	45
47860-76	30	24

Spheres/Sfere

art.	Ø mm.	gr.	pcs/pz
47860-77	50	15	8

Spheres/Sfere

art.	Ø mm.	gr.	pcs/pz
47860-78	100	90	2

**SILKSCREENED PRALINES MM 275 × 135**  
PRALINE SERIGRAFATE MM 275 × 135

**PC**



Place the silk screen sheet on the base of the mold, cutting it to the right size. Put the sheet with the transfer part facing upwards and close the mold. Fill with chocolate and leave to cool. When cool, open the mold and turn out the chocolates.

Collocare il foglio serigrafato sul fondo dello stampo tagliandolo a misura. Posare il foglio con la parte trasferibile verso l'alto e chiudere lo stampo. Riempire gli stampi e lasciare solidificare il cioccolato. Raffreddati, sformare i cioccolatini.



Magnetic mold pcs 15  
Stampo magnetico gr 13

art. Ø mm.  
47863-01 30



Magnetic mold pcs 15  
Stampo magnetico gr 15

art. dim. mm.  
47863-02 33X25



Magnetic mold pcs 15  
Stampo magnetico gr 13

art. dim. mm.  
47863-03 27X27



Magnetic mold pcs 15  
Stampo magnetico gr 10

art. dim. mm.  
47863-04 27X25



PE



**Chocolate bars, set 5 pcs**

Tavolette cioccolato, set 5 pz

Schokoladentafel, 5 Stk

Tablettes chocolat, 5 pièces

Tabletas chocolate, 5 piezas

art. dim. cm.

47870-17 15x17

47870-18 15x17

47870-19 15x17



PC

**Spoon mold**

Stampo cucchiaino

Löffelform

Moule à cuillère

Molde cuchara

art. dim. mm.

47860-90 25x95



PC

**Coffee cup mold**

Stampo tazza caffè

Kaffeetassenform

Moule tasse à café

Molde taza café

art. Ø mm. h. pcs/pz

47860-91 51 32 7

47860-92 59 36 7

**Mold/Stampo 17,5x27,5 cm.**



PC

**Saucer mold**

Stampo piattino

Untertassenform

Moule de soucoupe

Molde platillo

art. Ø mm. pcs/pz

47860-93 80 5

47860-94 91 3

**Mold/Stampo 17,5x27,5 cm.**





**NEW**

**Egg mold kit**

Stampo uovo kit  
Ostereierform-Kit  
Moule à oeuf en kit  
Molde para huevo

art.	Ø mm.	h.	gr.	pcs/pz
47862-87	120	185	280	2

**Thermoformed plastic. – Plastica termoformata.**



**NEW**

**Egg mold kit**

Stampo uovo kit  
Ostereierform-Kit  
Moule à oeuf en kit  
Molde para huevo

art.	Ø mm.	h.	gr.	pcs/pz
47862-88	115	155	230	2

**Thermoformed plastic. – Plastica termoformata.**



**NEW**

**Egg mold kit**

Stampo uovo kit  
Ostereierform-Kit  
Moule à oeuf en kit  
Molde para huevo

art.	Ø mm.	h.	gr.	pcs/pz
47862-89	122	185	270	2

**Thermoformed plastic. – Plastica termoformata.**



**Half egg mold, strong plastic (PETG)**

Stampo 1/2 uovo, plastica rigida  
Ostereierform 1/2  
Moule à 1/2 oeuf  
Molde para 1/2 huevo

art.	dim. cm.	Kg.
47876-11	17x25	0,5-1,0
47876-12	18x28	0,8-1,2
47876-13	34x25	1,5-2,0
47876-14	27x40	2,0-2,5
47876-15	32x45	2,5-3,5
47876-16	36x54	4,0-6,0
47876-17	43x64	6,0-8,0
47876-18	50x75	8,0-10,0



**PC**

**Half egg mold**

Stampo 1/2 uovo  
Ostereierform 1/2  
Moule à 1/2 oeuf  
Molde para 1/2 huevo

art.	dim. mm.	gr.	pcs/pz
47862-80	44x64	25	10
47862-81	75x105	70	4
47862-82	90x130	150	2
47862-83	104x150	230	2
47862-84	121x175	260	1
47862-85	141x204	380	1
47862-86	157x227	430	1



**PE**

**Egg mold**

Stampo uovo  
Ostereierform  
Moule à oeuf  
Molde para huevos

art.	dim. mm.	pcs/pz
47865-44	220x160x85	1
47865-23	110x80x40	2
47865-80	112x83x44	2
47865-81	125x94x44	2
47865-82	140x100x50	2
47865-83	154x110x55	2



**PE**

**Egg mold**

Stampo uovo  
Ostereierform  
Moule à oeuf  
Molde para huevos

art.	dim. mm.	pcs/pz
47865-66	80x60x25	4
47865-73	40x31x17	14
47865-71	36x23x12	18



**PE**

**Egg mold**

Stampo uovo  
Ostereierform  
Moule à oeuf  
Molde para huevos

art.	dim. mm.	pcs/pz
47865-74	64x44x26	6
47865-72	39x25x13	14



**PE**

**Egg mold**

Stampo uovo  
Ostereierform  
Moule à oeuf  
Molde para huevos

art.	dim. mm.	pcs/pz
47865-77	140x100x49	1
47865-76	95x70x40	2
47865-75	83x54x24	4



3D HOLLOW MOLDS/STAMPI 3D CORPO CAVO  
3D-HOHLFORME/MOULES CREUSES 3D/MOLDE 3D

PC



Easter/Pasqua

art.	h. mm.
47793-11	170



Easter/Pasqua

art.	h. mm.
47793-12	180



Easter/Pasqua

art.	h. mm.
47793-13	140



Easter/Pasqua

art.	h. mm.	#
47793-15	170	2



Easter/Pasqua

art.	h. mm.
47793-16	150



Easter/Pasqua

art.	h. mm.
47793-18	205



Easter/Pasqua

art.	h. mm.
47793-20	160



Easter/Pasqua

art.	h. mm.	#
47793-23	110	3



Easter/Pasqua

art.	h. mm.
47793-26	110



Christmas/Natale

art.	h. mm.	#
47793-32	122	3



Christmas/Natale

art.	h. mm.
47793-33	180



Christmas/Natale

art.	h. mm.
47793-40	168



Christmas/Natale

art.	h. mm.	#
47793-43	114	3



Christmas/Natale

art.	h. mm.
47793-45	135



Ball/Pallone

art.	h. mm.
47793-52	120



Shoe/Scarpa

art.	dim. mm.
47793-55	220x75x170



**FRUITS/TUTTIFRUTTI CM 40X30**

Silicone molds cm 40x30, to create original dessert and surprising monoportions.

Stampi in silicone cm 40x30, per realizzare dessert al piatto e monoportzioni.



**Pear**  
Pera

art.	Ø mm.	h.	ml.	pcs/pz
47745-06	53	70	90	20

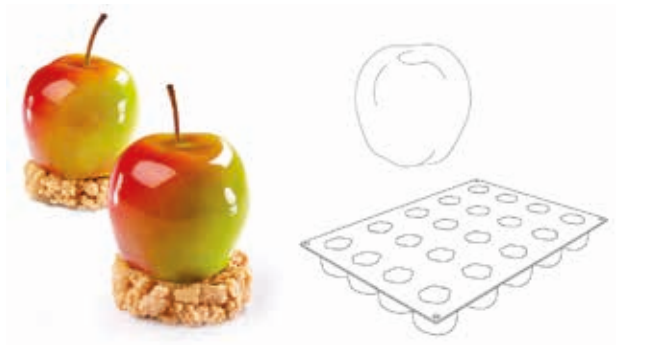

**Apple**  
Mela

art.	Ø mm.	h.	ml.	pcs/pz
47745-07	55	48	90	20



**Peach/Cherry**  
Pesca/Ciliegia

art.	dim. mm.	ml.	pcs/pz
47745-08	58x53x46	90	20

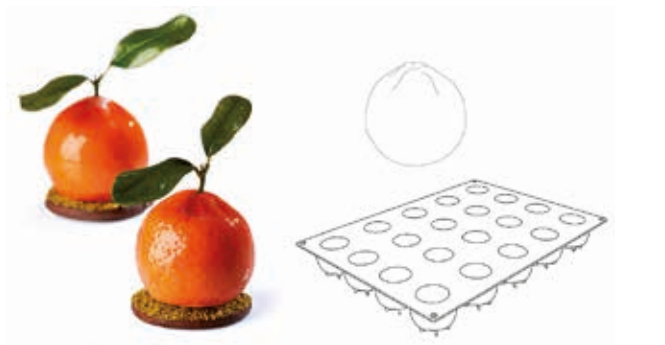

**Tangerine**  
Mandarino

art.	Ø mm.	h.	ml.	pcs/pz
47745-09	57	50	90	20

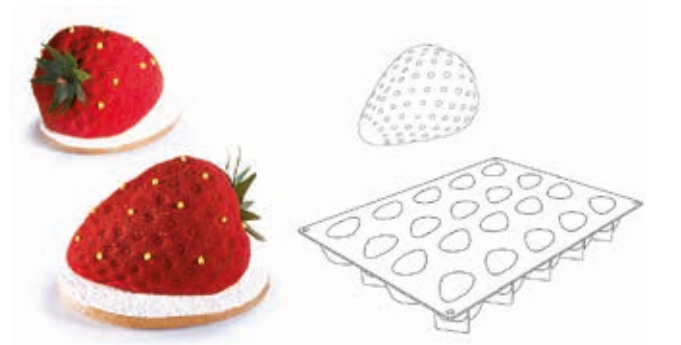

**Strawberry**  
Fragola

art.	dim. mm.	ml.	pcs/pz
47745-10	71x54x46	90	20

SILICONE MOLDS CM 60X40 - CM 40X30  
STAMPI SILICONE CM 60X40 - CM 40X30



**Quenelle 60x40**

art.	dim. mm.	ml.	pcs/pz
47746-01	66x33x30	32	49



**Mini quenelle 60x40**

art.	dim. mm.	ml.	pcs/pz
47746-02	42x20x20	8	100

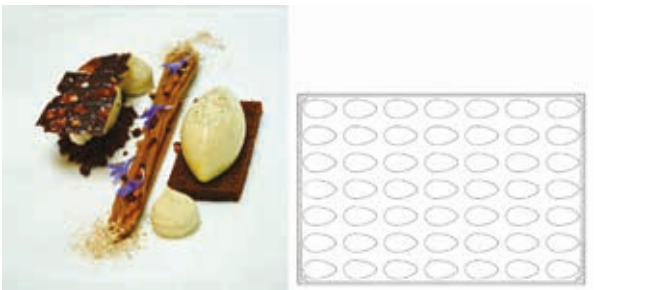

**Quenelle 60x40**

art.	dim. mm.	ml.	pcs/pz
47746-03	66x35x26	34	49



**Mini quenelle 60x40**

art.	dim. mm.	ml.	pcs/pz
47746-04	42x22x17	9	100



**Sphere 40x30**

art.	Ø mm.	ml.	pcs/pz
47745-02	20	4	48



**Sphere 40x30**

art.	Ø mm.	ml.	pcs/pz
47745-03	30	14	30



**Sphere 40x30**

art.	Ø mm.	ml.	pcs/pz
47745-04	40	33	24



**Sphere 40x30**

art.	Ø mm.	ml.	pcs/pz
47745-05	50	65	20



**100% PLATINUM SILICONE CAKE MOLDS, CM 17,5X30 - GN 1/3**  
STAMPI IN SILICONE PLATINICO 100%, CM 17,5X30 - GN 1/3



Suitable for freezing and baking (resistance from -40°C up to +280°C). For a correct use, put the moulds on grills or perforated trays, in order to improve the heat diffusion during baking. High non-stick properties to let a perfect demoulding of the product. Can be whashed by hand or in dishwasher. Manufactured in conformity with international regulations concerning food contact: D.M. no. 104 of 21/03/1973 (Italian law) - Arrêté du 25/11/1992 (French law) - BGVV (German law) - FDA (USA law).

Adatti per la surgelazione e la cottura (resistono da -40°C a +280°C). Per un utilizzo ottimale, posizionare gli stampi su griglie o teglie forate per favorire la diffusione del calore durante la cottura. Elevata antiaderenza per consentire una perfetta sformatura del prodotto. Lavabili a mano e in lavastoviglie. Conforme alle norme internazionali che regolano l'utilizzo di materiali destinati al contatto con sostanze alimentari: D.M. n. 104 del 21/03/1973 (legislazione italiana) - Arrêté du 25/11/1992 (legislazione francese) - BGVV (legislazione tedesca) - FDA (legislazione statunitense).



**Big baba**  
Babà grande

art.	Ø mm.	h.	ml.	pcs/pz
47742-02	55	60	97	8



**Medium baba**  
Babà medio

art.	Ø mm.	h.	ml.	pcs/pz
47742-30	45	48	51	11



**Small baba**  
Babà piccolo

art.	Ø mm.	h.	ml.	pcs/pz
47742-31	35	38	25	15



**Bavarian**  
Bavarese

art.	Ø mm.	h.	ml.	pcs/pz
47742-41	57	57	110	8



**Fluted cake**  
Briochette cannellata

art.	Ø mm.	h.	ml.	pcs/pz
47742-12	79	30	109	6



**Fluted cake**  
Briochette cannellata

art.	Ø mm.	h.	ml.	pcs/pz
47742-27	79	37	100	6



**Cake**

Cake

art.	dim. mm.	ml.	pcs/pz
47742-56	80x30x30	62	9



**Cannelle**

Cannelle

art.	Ø mm.	h.	ml.	pcs/pz
47742-51	56	50	70	8



**Cylinder**

Cilindro

art.	Ø mm.	h.	ml.	pcs/pz
47742-17	60	35	89	8



**Heart**

Cuore

art.	dim. mm.	ml.	pcs/pz
47742-25	65x60x35	97	8



**Biscuit disc**

Disco biscuit

art.	Ø mm.	h.	ml.	pcs/pz
47742-23	103	20	160	3



**Florentine**

Florentine

art.	Ø mm.	h.	ml.	pcs/pz
47742-19	60	12	27	8



**Madeleine**

Madeleine

art.	dim. mm.	ml.	pcs/pz
47742-21	68x45x18	30	9
47742-37	42x30x11,5	8	20



**Mini cannelle**

Mini cannelle

art.	Ø mm.	h.	ml.	pcs/pz
47742-42	35	35	24	18



**Mini financier**

Mini finanziere

art.	dim. mm.	ml.	pcs/pz
47742-14	49x26x11	11	20



**Mini guglhupf**

Mini guglhupf

art.	Ø mm.	h.	ml.	pcs/pz
47742-34	60	33	70	6



**Mini muffin**

Mini muffin

art.	Ø mm.	h.	ml.	pcs/pz
47742-20	50	28	43	11



**Mini oval**

Mini ovale

art.	dim. mm.	ml.	pcs/pz
47742-09	53x33x20	28	16



**Mini pyramid**

Mini piramide

art.	dim. mm.	ml.	pcs/pz
47742-13	36x36x22	13	15





**Mini savarin**

**Mini savarin**

art.	Ø mm.	h.	ml.	pcs/pz
47742-05	41	12	12	18



**Muffin**

**Muffin**

art.	Ø mm.	h.	ml.	pcs/pz
47742-08	70	40	130	6



**Muffin**

**Muffin**

art.	Ø mm.	h.	ml.	pcs/pz
47742-33	80	35	110	5



**Petit four**

**Petit four**

art.	Ø mm.	h.	ml.	pcs/pz
47742-24	40	20	22	15



**Pyramid**

**Piramide**

art.	dim. mm.	ml.	pcs/pz
47742-07	71x71x40	92	6



**Pomponette**

**Pomponette**

art.	Ø mm.	h.	ml.	pcs/pz
47742-06	34	16	13	24



**Savarin**

**Savarin**

art.	Ø mm.	h.	ml.	pcs/pz
47742-15	72	23	67	6



**Savarin**

**Savarin**

art.	Ø mm.	h.	ml.	pcs/pz
47742-10	65	21	49	8



**Half sphere**

**Semisfera**

art.	Ø mm.	h.	ml.	pcs/pz
47742-04	30	17	8,5	24



**Half sphere**

**Semisfera**

art.	Ø mm.	h.	ml.	pcs/pz
47742-03	40	20	17	15



**Half sphere**

**Semisfera**

art.	Ø mm.	h.	ml.	pcs/pz
47742-48	50	23	33	15



**Half sphere**

**Semisfera**

art.	Ø mm.	h.	ml.	pcs/pz
47742-47	60	30	57	8



**Half sphere**

**Semisfera**

art.	Ø mm.	h.	ml.	pcs/pz
47742-01	70	35	89	6



**Half sphere**

**Semisfera**

art.	Ø mm.	h.	ml.	pcs/pz
47742-29	80	40	134	5



**Tartlet**

**Tartelletta**

art.	Ø mm.	h.	ml.	pcs/pz
47742-16	50	15	20	15



**Cakes**

**Tortine**

art.	Ø mm.	h.	ml.	pcs/pz
47742-61	80	18	85	6



**Round cake tin**

**Tortiera tonda**

art.	Ø mm.	h.	ml.
47765-24	240	42	1850
47765-26	260	45	2250
47765-28	280	45	2600



**Fluted round cake tin**

**Tortiera tonda cannellata**

art.	Ø mm.	h.	ml.
47766-26	260	30	1350
47766-28	280	30	1600
47766-30	300	30	1850



**Tart tin**  
Crostata

art.	Ø mm.	h.	ml.
47771-28	280	30	1700



**Heart cake tin**  
Tortiera cuore

art.	dim. mm.	ml.
47770-21	220x218x35	1150



**Plumcake**  
Plumcake

art.	dim. mm.	ml.
47773-24	240x105x65	1385
47773-28	280x105x65	1660



**Rectangulat cake pan**  
Tortiera rettangolare

art.	dim. mm.	ml.
47769-28	280x240x40	2670



**Drainer**  
Sgocciolatore

art.	dim. cm.
47742-00	30x30x17,5

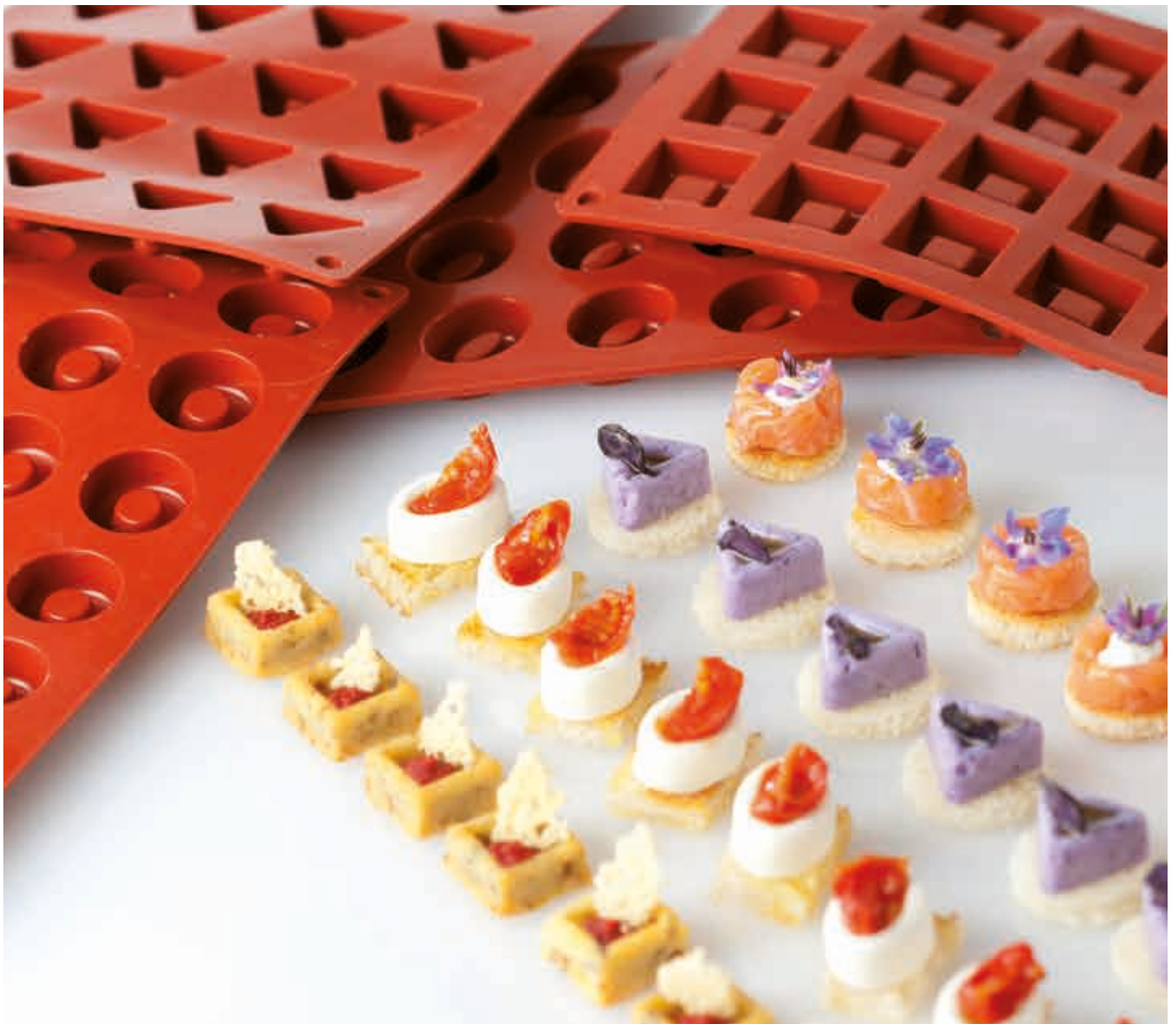
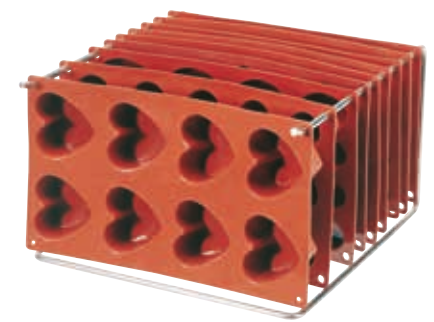

# FLEXIPAN



PASTRY  
PASTICCERIA



The Sasa Demarle Group is the only company in the world to formulate and produce its own food silicone, specially designed for the bakery and pastry industry. The use of this silicone allows an optimal heat distribution, which offers an even baking and colour, as well as perfect non-stick properties for an easy and perfect demoulding. The Flexipan moulds offer great performances with high lifetime expectancy: from 3,000 to 5,000+ baking cycles, depending on the conditions of use. Can be used for cooking and freezing (from -40°C to +240°C), for sweet and/or savory recipes. Can be easily cleaned with water.

Il gruppo Sasa Demarle è l'unica azienda al mondo a formulare e produrre il proprio silicone alimentare, appositamente progettato per l'industria della panificazione e della pasticceria. L'uso di questo silicone consente una distribuzione ottimale del calore, offrendo una cottura e un colore uniformi, nonché proprietà antiaderenti perfette per una facile e perfetta sfornatura. Gli stampi Flexipan offrono grandi prestazioni con un'elevata aspettativa di durata: da 3.000 a 5.000+ cicli di cottura, a seconda delle condizioni di utilizzo. Può essere utilizzato per cucinare e congelare (da -40°C a +240°C), per ricette dolci e/o salate. Si pulisce facilmente con acqua.



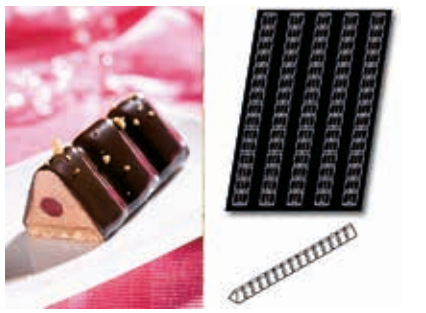

**Annapurna**

Pcs/pz 5 - ml. 370

art. mm.

47740137 495x40x33

With s/s frame. – Con supporto inox.



**Bavarois**

Pcs/pz 18 - ml. 100

art. Ø mm. h.

47740105 78 35



**Butterfly**

Pcs/pz 24 - ml. 60

art. mm.

47740141 70x60x20



**Caterpillar**

Pcs/pz 5 - ml. 450

art. mm.

47740138 495x40x36

With s/s frame. – Con supporto inox.



**Champagne biscuits**

Pcs/pz 45 - ml. 20

art. mm.

47740-29 109x24x10



**Charlotte**

Pcs/pz 24 - ml. 60

art. Ø mm. h.

47740-80 62 35



**Charlotte**

Pcs/pz 18 - ml. 100

art. Ø mm. h.

47740-23 78 40



**Chocolate bars**

Pcs/pz 18 - ml. 100

art. mm.

47740128 78x58x40

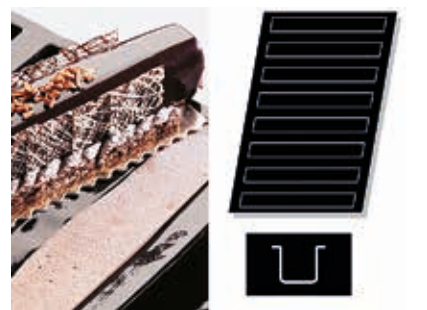

**Christmas log**

Pcs/pz 8 - ml. 450

art. mm.

47740-28 339x40x39



**Christmas log**

Pcs/pz 24 - ml. 80

art. mm.

47740-26 95x40x30



**Christmas log**

Pcs/pz 24 - ml. 115

art. mm.

47740-27 122x42x32



**Christmas log insert**

Pcs/pz 5 - ml. 700

art. mm.

47740-93 495x40x39

With s/s frame. – Con supporto inox.



**Christmas tree**

Pcs/pz 20 - ml. 100

art.	mm.
47740119	90x85x30



**Cylinders**

Pcs/pz 24 - ø 63 mm.

art.	h. mm.	ml.
47740-52	25	65
47740-06	35	90

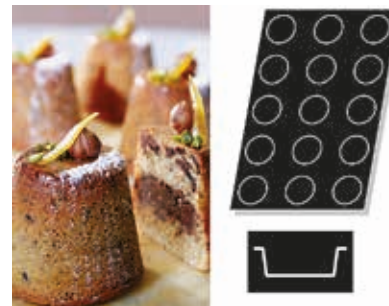

**Cylinders**

Pcs/pz 15

art.	Ø mm.	h.	ml.
47740-69	82	50	220
47740-70	91	35	190



**Cone insert**

Pcs/pz 40 - ml. 24

art.	Ø mm.	h.
47740102	50	40



**Cones**

Pcs/pz 20 - ml. 80

art.	Ø mm.	h.
47740103	70	60



**Cookies**

art.	Ø mm.	h.	ml.	pcs
47740-18	59	13	30	40
47740-60	78	10	50	24



**Cookies**

Pcs/pz 12

art.	Ø mm.	h.	ml.
47740-74	100	35	245
47740-75	105	40	305



**Florentins XL**

Pcs/pz 15 - ml. 60

art.	Ø mm.	h.
47740-61	91/87	8



**Eggs**

Pcs/pz 25 - ml. 95

art.	mm.
47740135	94x60x31



**Exagon**

Pcs/pz 60 - ml. 12

art.	mm.
47740-83	45x40x12

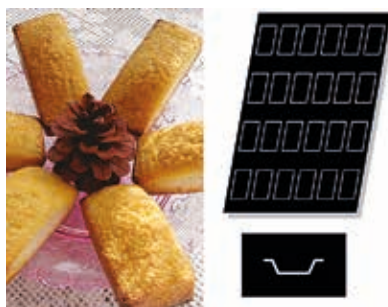

**Financiers**

Pcs/pz 24 - ml. 45

art.	mm.
47740-10	86x46x14



**Flan bases**

Pcs/pz 24 - ml. 70

art.	Ø mm.	h.
47740-43	80	20



**Fluted brioches**

Pcs/pz 24 - ml. 60

art. mm.  
47740-57 62x49x26



**Fluted brioches**

Pcs/pz 24

art.	Ø mm.	h.	ml.
47740-58	68	25	60
47740-59	78	30	105
47740-16	81	37	105



**Fluted cakes**

Pcs/pz 16 - ml. 105

art. mm.  
47740-95 110x60x25



**Fluted ingots**

Pcs/pz 24 - ml. 90

art. mm.  
47740127 106x46x25



**Fluted tartlets**

Pcs/pz 24 - ml. 70

art. mm.  
47740132 78x78x20



**Half cylinder**

Pcs/pz 48 - ml. 20

art. mm.  
47740125 85x17x15

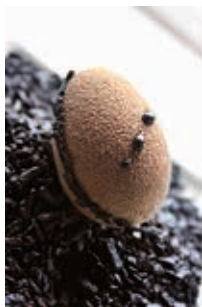

**Half egg**

Pcs/pz 56 - ml. 20

art. mm.  
47740140 55x35x20



**Half sphere**

Pcs/pz 48 - ml. 20

art. Ø mm. h.  
47740-02 42 21



**Half sphere**

Pcs/pz 24 - ml. 125

art. Ø mm. h.  
47740-38 80 40



**Half sphere**

Pcs/pz 28 - ml. 50

art. Ø mm. h.  
47740-37 58 31



**Half sphere**

Pcs/pz 24 - ml. 105

art. Ø mm. h.  
47740-03 70 40



**Hearts**

Pcs/pz 81 - ml. 20

art. mm.  
47740-89 75x65x35



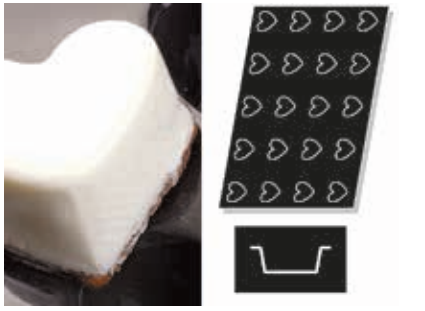

**Hearts**

Pcs/pz 20 - ml. 90

art. mm.

47740-41 66x62x35



**Hexagons**

Pcs/pz 20 - ml. 90

art. Ø mm. h.

47740130 80 25

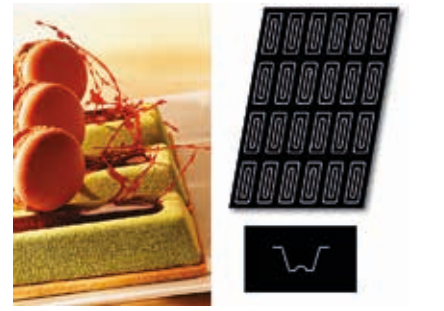

**Hollow ingot**

Pcs/pz 24

art. mm. ml.

47740123 100x40x25 70

47740124 120x40x25 90



**Ingot**

Pcs/pz 24 - ml. 100

art. mm.

47740122 120x40x25

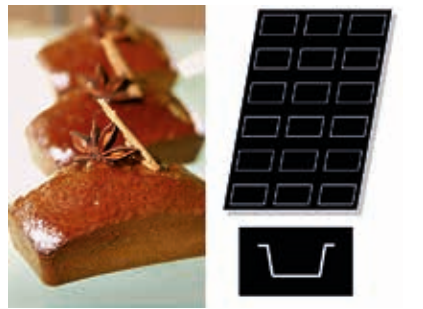

**Ingot**

Pcs/pz 18 - ml. 139

art. mm.

47740-94 102x58x30



**Interlacing hearts**

Pcs/pz 8 - ml. 200

art. mm.

47740101 120x113x35



**Landscapes**

Pcs/pz 27 - ml. 80

art. Ø mm. h.

47740144 75 24



**Little cushion**

Pcs/pz 24 - ml. 70

art. mm.

47740-77 71x57x23

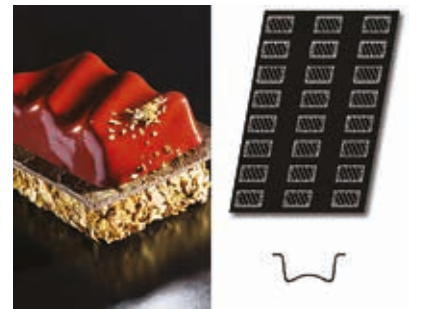

**Little waves**

Pcs/pz 24 - ml. 76

art. mm.

47740121 79x49x25

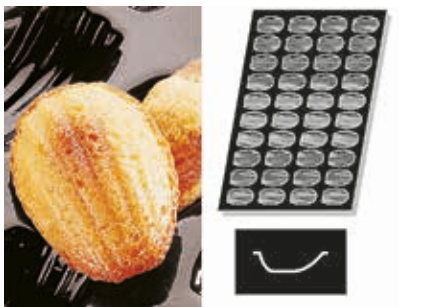

**Madeines**

Pcs/pz 40 - ml. 35

art. mm.

47740-17 78x47x19



**Medallions**

Pcs/pz 54 - ml. 14

art. Ø mm. h.

47740-50 38 10



**Medallions**

Pcs/pz 96 - ml. 5

art. Ø mm. h.

47740-97 28 8



**Mini Charlotte**

Pcs/pz 60 - ml. 9

art.	Ø mm.	h.
47740-82	35	15

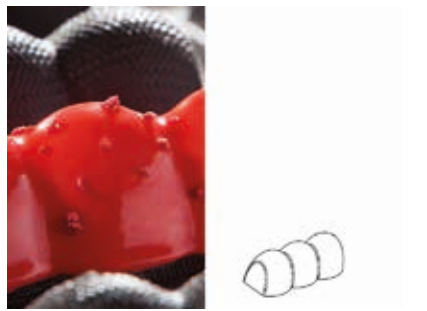

**Mini chenilles**

Pcs/pz 27 - ml. 90

art.	mm.
47740143	102x40x36



**Mini drops**

Pcs/pz 56 - ml. 18

art.	mm.
47740133	52x32x20



**Mini écrins**

Pcs/pz 24 - ml. 65

art.	mm.
47740142	50x50x29



**Mini Madeleines**

Pcs/pz 56 - ml. 15

art.	mm.
47740106	52x33x15



**Mini St Honoré crown**

Pcs/pz 18 - ml. 70

art.	Ø mm.	h.
47740131	80	20



**Muffins**

Pcs/pz 24

art.	Ø mm.	h.	ml.
47740-19	73	40	125
47740-68	79	36	115



**Optagon**

Pcs/pz 40 - ml. 28

art.	mm.
47740-34	43x40x26



**Oval savorins**

Pcs/pz 12 - ml. 230

art.	mm.
47740-81	100x80x45

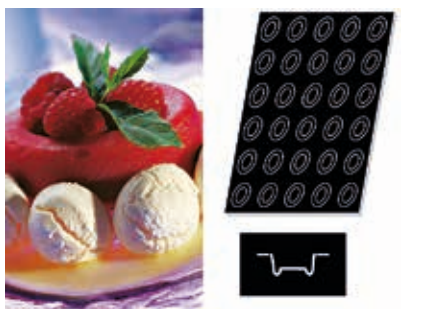

**Oval savorins**

Pcs/pz 30 - ml. 48

art.	mm.
47740111	70x50x22



**Oval savorins**

Pcs/pz 24 - ml. 70

art.	mm.
47740-44	80x60x25



**Oval tartlets**

Pcs/pz 30 - ml. 35

art.	mm.
47740-32	106x45x15



**Ovals**

Pcs/pz 24 - ml. 80

art. mm.

47740-49 96x45x28



**Ovals**

Pcs/pz 30

art. mm. ml.

47740-46 70x50x25 55

47740-47 70x50x30 75



**Ovals**

Pcs/pz 20 - ml. 100

art. mm.

47740-48 85x60x30



**Ovals**

Pcs/pz 48 - ml. 15

art. mm.

47740-92 70x30x10



**Ovals**

Pcs/pz 24 - ml. 80

art. mm.

47740-55 130x48x18



**Pomponnettes**

Pcs/pz 96 - ml. 14

art. Ø mm. h.

47740-04 36 17



**Puddings**

Pcs/pz 15 - ml. 128

art. Ø mm. h.

47740104 65 55



**Pyramids**

Pcs/pz 24 - ml. 90

art. mm.

47740-13 71x71x41



**Pyramids flat bottom**

Pcs/pz 35 - ml. 50

art. mm.

47740-39 50x50x35



**Quiches**

Pcs/pz 15 - ml. 135

art. Ø mm. h.

47740-85 96 25



**Quiches**

Pcs/pz 24 - ml. 65

art. Ø mm. h.

47740-30 77 20



**Quiches**

Pcs/pz 42 - ml. 30

art. mm.

47740-45 60x40x25

**PAstry PASTICCERIA  
FLEXIPAN SILICONE 60X40 CM**



**Quiches**

Pcs/pz 15 - ml. 140

art.	Ø mm.	h.
47740-62	102	20



**Quiches**

Pcs/pz 6

art.	Ø mm.	h.	ml.
47740-64	147	12	200
47740-65	150	15	250
47740-66	166	12	250



**Quiches**

Pcs/pz 6

art.	Ø mm.	h.	ml.
47740-71	140	25	360
47740-72	150	24	390
47740-05	186	12	300



**Rectangular cakes**

Pcs/pz 24 - ml. 55

art.	mm.
47740-25	80x30x30



**Rectangular cakes**

Pcs/pz 25 - ml. 110

art.	mm.
47740-24	89x46x25

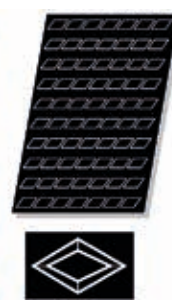

**Rhombus**

Pcs/pz 70 - ml. 9

art.	mm.
47740-36	60x35x10



**Round**

Pcs/pz 11 - ml. 75

art.	Ø mm.	h.
47740-63	125	16



**Round brioche**

Pcs/pz 24 - ml. 65

art.	Ø mm.	h.
47740-56	79	15



**Savarin zaphire**

Pcs/pz 24 - ml. 80

art.	mm.
47740114	70x70x32



**Savarins**

Pcs/pz 35 - ml. 50

art.	Ø mm.	h.
47740-20	66	20



**Savarins**

Pcs/pz 24 - ml. 65

art.	Ø mm.	h.
47740-15	70	23



**Scoop out**

Pcs/pz 24 - ml. 90

art.	mm.
47740145	85x61x30





**Shells**

Pcs/pz 24 - ml. 70

art. mm.

47740-79 80x75x20

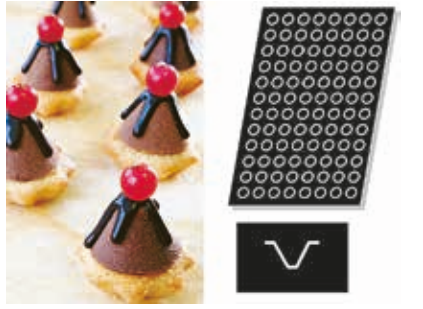

**Small cones**

Pcs/pz 96 - ml. 6

art. Ø mm. h.

47740-99 30 20

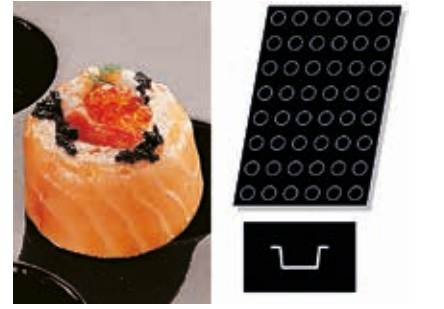

**Small cylinders**

Pcs/pz 48 - ml. 25

art. Ø mm. h.

47740-51 40 20



**Small financiers**

Pcs/pz 84 - ml. 10

art. mm.

47740-09 50x26x11



**Small fluted tartlet**

Pcs/pz 40 - ml. 11

art. mm.

47740100 46x38x15



**Small half sphere**

Pcs/pz 96 - ml. 6

art. Ø mm. h.

47740-87 26 16



**Small half sphere**

Pcs/pz 70 - ml. 10

art. Ø mm. h.

47740-01 29 18



**Small hearts**

Pcs/pz 70 - ml. 15

art. mm.

47740115 41x38x16



**Small muffins**

Pcs/pz 40 - ml. 45

art. Ø mm. h.

47740-67 51 29



**Small oval savorins**

Pcs/pz 60 - ml. 9

art. mm.

47740-98 40x30x12



**Small oval tartlets**

Pcs/pz 48 - ml. 10

art. mm.

47740-31 66x27x11



**Small ovals**

Pcs/pz 50 - ml. 20

art. mm.

47740-11 51x31x20





**Small ovals flat bottom**

Pcs/pz 64 - ml. 18

art. mm.

47740-91 57x35x12

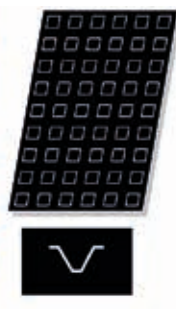

**Small pyramids**

Pcs/pz 54 - ml. 15

art. mm.

47740-12 35x35x23

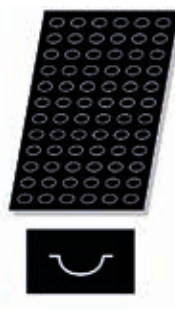

**Small quenelles**

Pcs/pz 72 - ml. 56

art. mm.

47740-90 42x26x20



**Small quiches**

Pcs/pz 54 - ml. 22

art. Ø mm. h.

47740-33 40 20



**Small quiches**

Pcs/pz 60 - ml. 13

art. Ø mm. h.

47740-07 42 10



**Small quiches**

Pcs/pz 48 - ml. 20

art. Ø mm. h.

47740-08 48 15



**Small quiches**

Pcs/pz 40 - ml. 35

art. Ø mm. h.

47740-84 58 20



**Small Savarins**

Pcs/pz 60 - ml. 15

art. mm.

47740107 7x37x17



**Small savarins**

Pcs/pz 60 - ml. 10

art. Ø mm. h.

47740-14 41 12

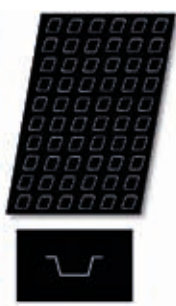

**Small squares**

Pcs/pz 60 - ml. 18

art. mm.

47740116 37x37x17

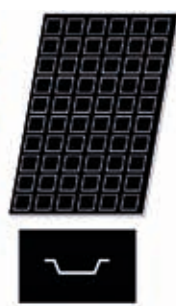

**Small squares**

Pcs/pz 60 - ml. 20

art. mm.

47740109 45x45x12



**Small upside-down half sphere**

Pcs/pz 45 - ml. 6

art. Ø mm. h.

47740-86 26 16





**Spoon**

Pcs/pz 36 - ml. 15

art. mm.

47740118 90x28x12



**Square Savarins**

Pcs/pz 35 - ml. 45

art. mm.

47740108 56x56x24



**Square Savarins**

Pcs/pz 24 - ml. 100

art. mm.

47740-96 70x70x30



**Squares**

Pcs/pz 35 - ml. 60

art. mm.

47740117 56x56x24



**Squares**

Pcs/pz 40 - ml. 40

art. mm.

47740110 60x60x15



**St Honoré crown**

Pcs/pz 6 - ml. 260

art. Ø mm. h.

47740129 150 26



**Stars**

Pcs/pz 24 - ml. 35

art. mm.

47740-88 80x65x15



**Tarte tatin**

Pcs/pz 15 - ml. 135

art. Ø mm. h.

47740-73 82 30



**Teddy bear**

Pcs/pz 18 - ml. 80

art. mm.

47740-53 90x55x20



**Triangles**

Pcs/pz 80 - ml. 7

art. mm.

47740-35 48x41x10



**Various petits-fours**

Pcs/pz 60

art. h.

47740134 22



**Zaphire**

Pcs/pz 54 - ml. 17

art. mm.

47740112 40x40x24



**Zaphire**

Pcs/pz 24 - ml. 75

art. mm.

47740113 70x70x35



**Calisson**

Pcs/pz 20 - ml. 118

art. mm.

47743-03 180x90x50



**Lemon**

Pcs/pz 20 - ml. 73

art. mm.

47743-05 85x65x34



**Triangles**

Pcs/pz 24 - ml. 80

art. mm.

47743-10 70x95x25



**Donuts**

Pcs/pz 8

art. Ø mm. h.

47743-13 88 30



**Insert ring**

Pcs/pz 24

art. Ø mm. h.

47743-15 61 9



**Ring 3D**

Pcs/pz 24

art. Ø mm. h.

47743-16 76 25



**Pearls**

Pcs/pz 15 - ml. 100

art. Ø mm. h.

47743-65 73 40

FLEXIPAN GN 1/1



**Small half sphere**

Pcs/pz 5 - ml. 63

art. Ø mm. h.

47741-76 23 11

FLEXIPAN CM 40X30



**Small hearts**

Pcs/pz 30 - ml. 15

art. mm.

47741-78 52x49x10

FLEXIPAN CM 40X30



**Half sphere flat**

Pcs/pz 48 - ml. 10

art. Ø mm. h.

47741-77 30 13

FLEXIPAN CM 40X30



**Twist**

Pcs/pz 48

art. Ø mm. h.

47741-00 32 20

FLEXIPAN CM 40X30



**NEW**

**Stars**

Pcs/pz 48

art.      Ø mm.    h.  
47741-01    32      13

**FLEXIPAN CM 40X30**



**NEW**

**Insert fingers**

Pcs/pz 18

art.      mm.  
47741-02    120x11

**FLEXIPAN CM 40X30**



**NEW**

**Sphere 3D**

Pcs/pz 8

art.      Ø mm.    h.  
47741-05    65      50

**FLEXIPAN CM 40X30**



**Cylinder**

Pcs/pz 24 - ml. 148

art.      Ø mm.    h.  
47744-30    70      40

**FLEXIPAT CM 60x40**



**Cube**

Pcs/pz 96 - ml. 17

art.      mm.  
47744-32    30x30x20

**FLEXIPAT CM 60x40**



**Kougloff**

Pcs/pz 24 - ml. 150

art.      Ø mm.    h.  
47744-31    80      54

**FLEXIPAT CM 60x40**



**Basic chic**

Pcs/pz 24 - ml. 130

art.      mm.  
47744-33    70x70x34

**FLEXIPAT CM 60x40**



**Diamond**

Pcs/pz 24 - ml. 100

art.      Ø mm.    h.  
47744-34    79      40

**FLEXIPAT CM 60x40**



**Waffles**

Pcs/pz 8 - ml. 100

art.      mm.  
47741-38    80x127x15

**FLEXIPAT CM 40X30**



**Fingers**

Pcs/pz 24 - ml. 54

art.      mm.  
47741-37    129x28x15

**FLEXIPAT CM 40X30**



**Buche**

art.      mm.      ml.  
47744-80    280x85x70    140



**Half sphere**

art.      Ø mm.    h.      ml.  
47744-81    180      90    1600



**Flexiform desserts**

art.	mm.	ml.
47744-58	253x253x45	222



**Flexiform desserts**

art.	mm.	ml.
47744-59	600x400x50	980



**Flexiform desserts**

art.	mm.
47744-48	480x280x13
47744-60	555x360x10
47744-62	555x360x20



**Rosette**

art.	Ø mm.
47744-10	240



**Venetian cane**

art.	mm.
47744-19	555x360



**Labyrinth**

art.	mm.
47744-21	600x400



**Bubbles**

art.	mm.
47744-36	600x400

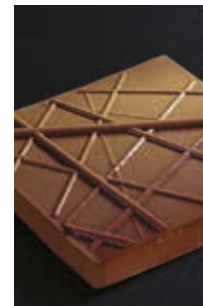

**Mikado**

art.	mm.
47744-37	600x400



**Snowflake**

art.	Ø mm.
47744-63	240



**Buche2**

art.	mm.
47744-70	275x185



**Buche1**

art.	mm.
47744-71	275x185



**SILFORM CM 60X40**  
PUFFS - BIGNE' - WINDBEUTEL - CHOUX - BOLLOS



This range has been developed especially for cream puffs dough. The pre-formed shapes make easy obtaining perfect, regular and same size cream puffs. Neither greasing the sheet nor spiking the dough is required before baking. The non-stick property of the material allows an easy and perfect extraction of the pastries. The base of the puff will be clear and plain for a perfect stability.

Supporto alveolare Silform® per cottura di pasta bignè. Questa gamma è stata sviluppata in particolare per la pasta di bignè. Grazie alle impronte preformate, preparare bignè uguali e regolari diventa facile. Non è più indispensabile nè spennellare con tuorlo nè forare la pasta. Grazie alle proprietà antiaderenti del Silform®, l'estrazione è impeccabile. La base del bignè sarà chiara e netta conferendogli così una perfetta stabilità. Silform® for Choux Pastry.



**Paris-Brest**

art.	Ø mm.	h.	ml.	pcs/pz
41760-27	80	15	50	24



**Oval choux**

art.	mm.	ml.	pcs/pz
41760-26	90x60x15	56	25



**Baby choux**

art.	Ø mm.	h.	ml.	pcs/pz
41760-22	30	5	4	59



**Big choux**

art.	Ø mm.	h.	ml.	pcs/pz
41759-01	67	15	48	28



**Eclairs - Right handed. Per ambidestri**

art.	mm.	ml.	pcs/pz
41760-20	125x25x5	15	18



**Eclairs - Left handed. Per mancini.**

art.	mm.	ml.	pcs/pz
41760-21	125x25x5	15	18

**SILFORM CM 60X40**  
BREADS - PANE - BROT - PAIN - PAN

Silform® baking sheets size 60x40 cm. Especially studied for breads, nonstick and ideal for a variety of small bread shapes: round, hot-dogs rolls, soft rolls, submarines, hamburger buns, sandwiches, etc., etc. Thanks to their perforated texture, the heat transfer is optimized, allowing unique crunchy and coloration. Can be used indifferently on aluminum baking trays or grids.

Supporti di cottura Silform® dim. 60x40 cm. Specifici per pane, antiaderenti, ideali per panini tondi, hot dogs, panini al latte, per hamburger, baguettes, ecc., ecc. La loro texture perforata ottimizza il trasferimento del calore per una perfetta croccantezza e doratura del prodotto. Si utilizzano indifferenteemente su teglie in alluminio o griglie.



**Round shapes/Rotondi**

Pcs/pz 28 - ml. 48

art.	Ø mm.	h. mm.
41759-01	67	15



**Round shapes/Rotondi**

Pcs/pz 24 - ml. 65

art.	Ø mm.	h. mm.
41759-02	75	17



**Round shapes/Rotondi**

Pcs/pz 24 - ml. 65

art.	Ø mm.	h. mm.
41759-03	79	15



**Round shapes/Rotondi**

Pcs/pz 15 - ml. 140

art.	Ø mm.	h. mm.
41759-05	102	20



**Round shapes/Rotondi**

Pcs/pz 11 - ml. 175

art.	Ø mm.	h. mm.
41759-09	125	16



**Oval shapes/Ovali**

Pcs/pz 24 - ml. 80

art.	mm.	h. mm.
41760-02	95x40	30



**Oval shapes/Ovali**

Pcs/pz 18

art.	mm.	h. mm.
41760-05	155x41	25



**Oval shapes/Ovali**

Pcs/pz 12

art.	mm.	h. mm.
41760-06	169x64	30



**Oval shapes/Ovali**

Pcs/pz 8

art.	mm.	h. mm.
41760-08	259x64	30



**Oval shapes/Ovali**

Pcs/pz 6

art.	mm.	h. mm.
41760-09	299x60	30





**French loaves perforated sheet, silicone coated**

Teglia alluminio forato, siliconata  
Pariserbrotblech, Silikon-beschichtet  
Plaque perforée pain parisien, siliconée  
Placa pan perforada, siliconada

art.	cm.	pcs/pz
41758-53	53x32	4
41758-60	60x40	5
41758-65	65x43	6
41758-85	85x43	6

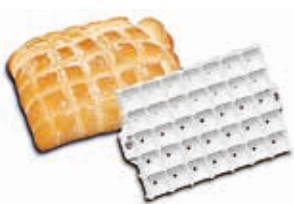

**ABS**

**Bread mould**

Stampo per pane  
Brot-Ausstechforme  
Découpoir à pain  
Cortador para pan

art.	cm.
47041-01	14x10



**ABS**

**Bread mould**

Stampo per pane  
Brot-Ausstechforme  
Découpoir à pain  
Cortador para pan

art.	cm.
47041-02	14x11



**ABS**

**Bread mould**

Stampo per pane  
Brot-Ausstechforme  
Découpoir à pain  
Cortador para pan

art.	Ø cm.
47041-03	12,5



**ABS**

**Bread mould**

Stampo per pane  
Brot-Ausstechforme  
Découpoir à pain  
Cortador para pan

art.	cm.
47041-04	16,5x8,5



**ABS**

**Bread mould**

Stampo per pane  
Brot-Ausstechforme  
Découpoir à pain  
Cortador para pan

art.	Ø cm.
47041-05	12,5



**ABS**

**Bread mould**

Stampo per pane  
Brot-Ausstechforme  
Découpoir à pain  
Cortador para pan

art.	Ø cm.
47041-06	8



**ABS**

**Bread mould**

Stampo per pane  
Brot-Ausstechforme  
Découpoir à pain  
Cortador para pan

art.	Ø cm.
47041-07	8



**ABS**

**Bread mould**

Stampo per pane  
Brot-Ausstechforme  
Découpoir à pain  
Cortador para pan

art.	Ø cm.
47041-08	8



**ABS**

**Bread mould**

Stampo per pane  
Brot-Ausstechforme  
Découpoir à pain  
Cortador para pan

art.	Ø cm.
47041-15	8





**ABS**

**Kaiser bread marker**  
 Marcatore pane Kaiser  
 Kaiserbrot Stempel  
 Empreinte pain Kaiser  
 Molde pan Kaiser

art.	Ø cm.	l. cm.
47040-00	6	20



**Bread brush**  
 Spazzola pane  
 Brot-Bürste  
 Brosse à pain  
 Cepillo para pan

art.	l. cm.
42614-04	24,5
42614-05	32,0
42614-06	41,0
42614-07	46,0



**SS**

**Disposable baker's blades**  
 Lama panettiere usa e getta  
 Einweg-Bäcker-Klingen  
 Incisette boulanger jetables  
 Láminas del panadero desechables

art.	l. cm.	pcs/pz
48290-10	12	10



**PE**

**Bread basket**  
 Cesta pane  
 Brot-Korb  
 Corbeille à pain  
 Cesta pan

art.	cm.	lt.
44982-04	57x36x34	40
44982-06	66x45x35	60
44982-10	78x52x40	100



**PP**

**Bread proofing basket**  
 Cestino impasto  
 Gärkorb  
 Banneton  
 Molde para pan

art.	Ø cm.	h.	gr.	col.
47042-19	19	7,5	500	●
47042-22	22	9,3	1000	●
47042-25	25	9,0	1500	●



**PP**

**Bread proofing basket**  
 Cestino impasto  
 Gärkorb  
 Banneton  
 Molde para pan

art.	cm.	gr.	col.
47043-27	27x12x6,5	500	●
47043-35	35x13x7,2	1000	●
47043-42	42x14x7,5	1500	●



# ETHNIC CUISINE CUCINA ETNICA

ASIA FUSION



The images of the products in this chapter reflect the characteristics of the products in the warehouse. However, they have to be considered mainly for illustrative purposes only. Although we make every effort to display the products accurately, the products received may vary slightly from those images. In any case the changes are intended as improvements and do not alter the function, nor lessen the utility of the product.

Tutte le foto degli articoli presenti nel capitolo rispecchiano il più possibile le caratteristiche dei prodotti presenti in magazzino. Teniamo comunque a precisare che le immagini sono indicative ed i prodotti reali potrebbero differire nei colori e nelle dimensioni. Le variazioni sono in ogni caso migliorative e tali da non alterare la natura e la funzionalità del prodotto stesso.

FINE MELAMINE SERIES THARA



Withstands temperatures from -20°C to +70°C.

Termoresistenti da -20°C a +70°C.



**Rice bowl**  
Coppa riso  
Reistasse  
Bol à riz  
Copa arroz

art.	Ø cm.	h.	lt.	col.
44463-11	11	7	0,3	●



**Tray**  
Vassoio  
Platte  
Plateau  
Placa

art.	dim. cm.	col.
44464-23	23,5x7,5x2	●



**Tray**  
Vassoio  
Platte  
Plateau  
Placa

art.	dim. cm.	col.
44465-24	24,5x6,5x1,5	●



**Bowl**  
Ciotola  
Schüssel  
Bol  
Bol Ensalada

art.	Ø cm.	h.	col.
44452-31	31	8,5	○
44452B31	31	8,5	●



**Bowl**  
Ciotola  
Schüssel  
Bol  
Bol Ensalada

art.	dim. cm.	col.
44453-14	14,5x12x5,5	○
44453B14	14,5x12x5,5	●



**Bowl**  
Ciotola  
Schüssel  
Bol  
Bol Ensalada

art.	Ø cm.	h.	col.
44454-11	11,5	4	○
44454B11	11,5	4	●



**Bowl**  
Ciotola  
Schüssel  
Bol  
Bol Ensalada

art.	dim. cm.	col.
44455-09	9x7x2,5	○
44455B09	9x7x2,5	●



**Bowl**  
Ciotola  
Schüssel  
Bol  
Bol Ensalada

art.	dim. cm.	col.
44456-14	14x9x2,5	○
44456B14	14x9x2,5	●



**Bowl**  
Ciotola  
Schüssel  
Bol  
Bol Ensalada

art.	dim. cm.	col.
44457-32	32,5x14x4	○
44457B32	32,5x14x4	●





**Tray**  
Vassoio  
Platte  
Plateau  
Placa

art.	dim. cm.	col.
44461-20	20x20x4,5	○
44461B20	20x20x4,5	●



**Bowl**  
Ciotola  
Schüssel  
Bol

**Bol Ensalada**

art.	dim. cm.	col.
44450-21	21x21x11	○
44450B21	21x21x11	●



**Bowl**  
Ciotola  
Schüssel  
Bol

**Bol Ensalada**

art.	dim. cm.	col.
44450-12	12x12x4	○
44450B12	12x12x4	●



**Bowl**  
Ciotola  
Schüssel  
Bol

**Bol Ensalada**

art.	dim. cm.	col.
44450-17	17,5x17,5x7	○
44450B17	17,5x17,5x7	●



**Tray**  
Vassoio  
Platte  
Plateau  
Placa

art.	dim. cm.	col.
44451-22	22x12x3	○
44451B22	22x12x3	●



**Tray**  
Vassoio  
Platte  
Plateau  
Placa

art.	dim. cm.	col.
44462-25	25x25x5,5	○
44462B25	25x25x5,5	●



**Dish**  
Piatto  
Teller  
Assiette  
Plato

art.	Ø cm.	h.	col.
44459-28	28	3	○
44459B28	28	3	●



**Bowl**  
Ciotola  
Schüssel  
Bol

**Bol Ensalada**

art.	dim. cm.	h.	col.
44450-11	11x10	3	○
44450B11	11x10	3	●



**Bowl**  
Ciotola  
Schüssel  
Bol

**Bol Ensalada**

art.	dim. cm.	h.	col.
44450-13	13x11	3,5	○
44450B13	13x11	3,5	●



**Bowl**  
Ciotola  
Schüssel  
Bol

**Bol Ensalada**

art.	dim. cm.	col.
44450-15	17,5x15,5x5,5	○
44450B15	17,5x15,5x5,5	●



**Tray**  
Vassoio  
Platte  
Plateau  
Placa

art.	dim. cm.	col.
44450-23	22x23,5x5,5	○
44450B23	22x23,5x5,5	●





MF

**Soba choko cup with cover**

Tazza soba choko con coperchio  
Soba Choko-Schale mit Deckel  
Coupe soba choko avec couvercle  
Taza soba choko con tapa

art. Ø cm. h.  
49655-47 8,5 6,5



MF

**Soup/rice bowl with lid**

Ciotola riso con coperchio  
Reisschüssel mit Deckel  
Bol à riz avec couvercle  
Bol arroz con tapa

art. Ø cm. h.  
49655-34 10 10

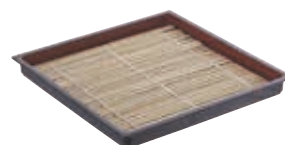

MF

**Zaru soba tray**

Vassoio zarusoba  
Zaru Soba-Tablett  
Plateau zaru soba  
Bandeja zaru soba

art. dim. cm.  
49655-48 19,5x19,5



MF

**Towel tray**

Vassoio portatovagliolo  
Handtuch-Tablett  
Plateau à serviette  
Bandeja servilleta

art. dim. cm.  
49655-46 17x7



MF

**Double Sided Tray**

Vassoio reversibile  
Platte, doppelseitig  
Plateau double face  
Bandeja doble cara

art. dim. cm.  
49655-20 35x31

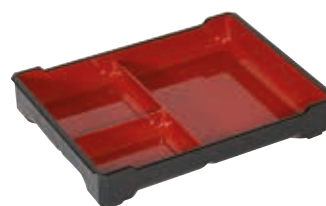

MF

**Bento tray**

Vassoio bento  
Bento-Platte  
Plateau à bento  
Bandeja bento

art. dim. cm.  
49655-36 22x16x3,5



MF

**Bento box with lid**

Scatola bento con coperchio  
Bento-Box mit Deckel  
Boîte à bento avec couvercle  
Caja bento con tapa

art. dim. cm.  
49655-44 30x24



MF

**Bento box with lid**

Scatola bento con coperchio  
Bento-Box mit Deckel  
Boîte à bento avec couvercle  
Caja bento con tapa

art. dim. cm.  
49655-37 24x24x5,5



MF

**Sushi serving dish**

Piatto a servire  
Sushi-Servierteller  
Plat à sushi  
Plato para sushi

art. Ø cm. h.  
49655-21 22 5,5  
49655-22 25 6  
49655-23 28 6



MF

**Sushi-sashimi bridge**

Ponte per sushi e sashimi  
Sushi-Brücke  
Sushi et sashimi pont  
Puente para sushi-sashimi

art. dim. cm.  
49655-41 28x13,5x6



B

**Sushi geta board**

Tagliere sushi  
Sushibrett  
Planche à sushi  
Tabla para sushi

art. dim. cm.  
49655-24 24x15x3



MF

**Hand roll stand, laquered**  
Supporto per temaki, laccato  
Temaki-Ständer  
Support pour temaki  
Soporte para temaki

art. dim. cm.  
49655-32 18x9,5x8



W

**Hand roll stand**  
Supporto per temaki  
Temaki-Ständer  
Support pour temaki  
Soporte para temaki

art. dim. cm.  
49655-31 18x9x8,5



MF

**Sushi-sashimi boat**  
Barca per sushi e sashimi  
Sushi-Sashimi-Boot  
Bateau sushi et sashimi  
Barco sushi-sashimi

art. dim. cm.  
49655-45 28x13,5x6



B

**Sushi-sashimi boat**  
Barca per sushi e sashimi  
Sushi-Sashimi-Boot  
Bateau sushi et sashimi  
Barco sushi-sashimi

art. dim. cm.  
49655-29 34x12x10,5



MF

**Soup spoon**  
Cucchiaio brodo  
Suppenlöffel  
Cuiller à soupe  
Cuchara sopa

art. dim. cm. col.  
44850-13 13,5x4,5 ○  
44850B13 13,5x4,5 ●



MF

**Soup spoon**  
Cucchiaio brodo  
Suppenlöffel  
Cuiller à soupe  
Cuchara sopa

art. l. cm.  
49655-35 14,5



PR

**Sauce pourer**  
Salsiera  
Sauciere  
Saucière  
Salsera

art. dim. cm. lt. U. Pack  
67305-57 7x11 0,2 6  
67308-57 5x4 0,03 6



PR

**Flat plate**  
Piattino piano  
Teller flach  
Petite assiette plate  
Platillo llano

art. dim. cm. U. Pack  
67303Q80 9x9 6  
67303Q81 12x12 6



PR

**Deep plate**  
Piattino fondo  
Teller tief  
Petite assiette creuse  
Platillo hondo

art. dim. cm. U. Pack  
67303Q82 9x9 6  
67303Q83 12x12 6



PR

**Small dish**  
Ciotolina  
Schale  
Petite assiette  
Platillo

art. dim. cm. U. Pack  
67303M01 9x7x3 6



PR

**Small dish**  
Piattino  
Schale  
Petite assiette  
Platillo

art. Ø cm. h. U. Pack  
67303M04 10,5 2 6



PR

**Small dish**  
Piattino  
Schale  
Petite assiette  
Platillo

art.	dim. cm.	U. Pack
67303M02	14x7x2	6



PR

**Small dish**  
Ciotolina  
Schale  
Petite assiette  
Platillo

art.	Ø cm.	h.	U. Pack
67303M03	10	2	6



PR

**Small dish**  
Ciotolina  
Schale  
Petite assiette  
Platillo

art.	dim. cm.	U. Pack
67303M05	11x8	6
67303M06	16x11	6



PR

**Chinese spoon**  
Cucchiaio cinese  
Löffel  
Cuillère chinoise  
Cucharita

art.	l. cm.	U. Pack
67303M07	13	12



PR

**Sake jug**  
Caraffa sake  
Sakekrug  
Carafe à sake  
Jarra sake

art.	Ø cm.	h.	ml.	col.
49655-25	5,2	13,5	120	○
49655-42	5,7	18,0	250	○



PR

**Sake jug**  
Caraffa sake  
Sakekrug  
Carafe à sake  
Jarra sake

art.	Ø cm.	h.	ml.	col.
49655-57	5,2	13,5	130	●
49655-58	5,7	18,0	230	●



PR

**Sake cup**  
Coppetta sake  
Sakebecher  
Coupe à sake  
Copa sake

art.	Ø cm.	h.	ml.
49655-26	4,5	4,5	40



PR

**Sake cup**  
Coppetta sake  
Sakebecher  
Coupe à sake  
Copa sake

art.	Ø cm.	h.	ml.	col.
49655-43	4,5	5,5	40	○
49655-60	4,5	5,5	40	●



PR

**Sake cup**  
Coppetta sake  
Sakebecher  
Coupe à sake  
Copa sake

art.	Ø cm.	h.
49655-56	5	4



PR

**Sake jug**  
Caraffa sake  
Sakekrug  
Carafe à sake  
Jarra sake

art.	Ø cm.	h.
49655-55	6	9,5



PR

**Sake warmer**  
Riscalda sake  
Sakewärmer  
Réchaud à sake  
Calentador de sake

art.	Ø cm.	h.
49655-54	9,5	9



PR

**Soy pot**  
Vaso soia  
Sojakrug  
Carafe soja sauce  
Jarra soja

art.	Ø cm.	h.
49655-52	12	7,5





**PR**

**Soy pot**

Vaso soia  
Sojakrug  
Carafe soja sauce  
Jarra soja

art.	Ø cm.	h.
49655-51	6,5	7



**PR**

**Soy pot**

Vaso soia  
Sojakrug  
Carafe soja sauce  
Jarra soja

art.	Ø cm.	h.	ml.
49655-53	5,5	8,5	130



**PR**

**Chopstick rest**

Supporto bacchette cinesi  
Ess-Stäbchen Ablage  
Pose baguettes  
Soporte para palillos

art.	dim. cm.	col.
49655-27	4,5x3	●
49655-28	4,5x3	○



**PR**

**Chopstick rest**

Supporto bacchette cinesi  
Ess-Stäbchen Ablage  
Pose baguettes  
Soporte para palillos

art.	dim. cm.
49655-61	6x1,5



**MF**

**Chopsticks**

Bacchette cinesi  
Ess-Stäbchen  
Baguettes  
Palillos

art.	l. cm.	pcs/pz
49658-01	27	2x10



**MF**

**Chopsticks**

Bacchette cinesi  
Ess-Stäbchen  
Baguettes  
Palillos

art.	l. cm.	pcs/pz
49658-02	27	2x10



**B**

**Disposable chopsticks**

Bacchette monouso  
Einweg Ess-Stäbchen  
Baguettes jetables  
Palillos desechables

art.	l. cm.	pcs/pz
48300-29	21	2x50



**B**

**Disposable chopsticks**

Bacchette monouso  
Einweg Ess-Stäbchen  
Baguettes jetables  
Palillos desechables

art.	l. cm.	pcs/pz
49627-22	24	2x100



**Japanese chopsticks, assorted colors**

Bacchette giapponesi, colori assortiti  
Japanische-Ess-Stäbchen  
Baguettes japonaises  
Palillos japoneses

art.	l. cm.	pcs/pz
49628-00	24	2x1



**SS**

**Japanese chopsticks**

Bacchette giapponesi  
Japanische-Ess-Stäbchen  
Baguettes japonaises  
Palillos japoneses

art.	l. cm.	pcs/pz
49655-30	23	2x5



**B**

**Noshikushi skewers**

Spiedini noshikushi  
Noshikushi Spieße  
Brochettes noshikushi  
Pinchos noshikushi

art.	l. cm.	pcs/pz
48300-42	10,5	100



**B**

**Tepokushi skewers**

Spiedini tepokushi  
Tepokushi Spieße  
Brochettes tepokushi  
Pinchos tepokushi

art.	l. cm.	pcs/pz
48300-43	9	100
48300-33	15	100





NEW  
W

**Mooncake mould flower**  
Stampo mooncake flower  
Mondkuchenform Flower  
Moule à mooncake flower  
Molde mooncake flower

art.  
49664-01



NEW  
W

**Mooncake mould fish**  
Stampo mooncake fish  
Mondkuchenform Fish  
Moule à mooncake fish  
Molde mooncake fish

art.  
49664-02



NEW  
W

**Mooncake mould long life**  
Stampo mooncake long life  
Mondkuchenform Long Life  
Moule à mooncake long life  
Molde mooncake long life

art.  
49664-03



NEW  
W

**Mooncake mould long life acadia**  
Stampo mooncake long life acadia  
Mondkuchenform Long Life Acadia  
Moule à mooncake long life acadia  
Molde mooncake long life acadia

art.  
49664-04



NEW  
W

**Mooncake mould double flower**  
Stampo mooncake double flower  
Mondkuchenform Double Flower  
Moule à mooncake double flower  
Molde mooncake double flower

art.  
49664-05



B

**Sushi mat**  
Stuoietta  
Sushi-Matte  
Natte à rouler les sushis  
Mantelín para sushi

art. dim. cm.  
49626-00 24x24



B

**Sushi mat**  
Stuoietta  
Sushi-Matte  
Natte à rouler les sushis  
Mantelín para sushi

art. dim. cm.  
49626-02 27x27



**Sushi-maki set 3 pcs**  
Kit 3 pz per sushi-maki  
Sushi-Maki-Satz 3 Stk  
Kit 3 pcs pour réaliser les sushi-maki  
Juego 3 pz para sushi-maki

art. dim. cm.  
49655-02 26x7,5x6



**Maki roll mould**  
Stampo per maki  
Maki-Ausstechform  
Moule à maki  
Molde para maki

art. dim. cm.  
49655-10 20,5x4x4



**Nigiri mould**  
Stampo per nigiri  
Nigiri-Ausstechform  
Moule à nigiri  
Molde para nigiri

art. dim. cm.  
49655-16 16x6x2,5



MF

**Rice spoon**  
Cucchiaio riso  
Reislöffel  
Cuiller à riz  
Cuchara arroz

art. dim. cm.  
49655-03 22x7



**B**

**Steamer**

Cuocivapore  
Dampfgarer  
Panier vapeur  
Vaporera

art.	Ø cm.
49603-15	16
49603-20	20
49603-25	25
49603-30	30
49603-40	40
49603-50	50

**2 bodies + 1 cover.** – 2 ceste + 1 coperchio.



**B**

**Steamer**

Cuocivapore  
Dampfgarer  
Panier vapeur  
Vaporera

art.	dim. cm.
49656-15	15,2x15,2
49656-16	16,5x16,5
49656-20	20,3x20,3



**W**

**Hangiri/sushi rice tub**

Vasca riso hangiri  
Hangiri/Sushi-Reis-Wanne  
Cuve è riz sushi/hangiri  
Barril arroz sushi/hangiri

art.	Ø cm.
49655-49	45
49655-50	60



**NEW**

**Serving basket sticky rice**

Contentitore per riso dolce  
Klebreis-Servierkorb  
Panier de service à riz gluant  
Cesta para servir arroz pegado

art.	Ø cm.
49660-09	9,5
49660-13	13,0

**Bamboo.**



**NEW**

**Sticky rice lao pot**

Pentola per riso dolce  
Klebreis Laotopf  
Marmite à riz gluant  
Olla para arroz pegado

art.	Ø cm.
49661-22	22
49661-24	24

**Aluminum.** – Alluminio.



**NEW**

**Sticky rice lao basket**

Cesto per riso dolce  
Klebreis-Laokorb  
Panier cuisson à riz gluant  
Cesta de cocción arroz pegado

art.	Ø cm.
49662-40	40
49662-50	50

**Bamboo.**



**NEW**

**Sticky rice cooking set**

Set cottura riso dolce  
Klebreis Kochset  
Ensemble de cuisson riz gluant  
Set de cocina arroz pegado

art.	Ø cm.
49663-22	22
49663-24	24

**Aluminum and bamboo.** – Alluminio e bamboo.



**Wok with grid and cover, 3-ply**

Wok c/griglia e coperchio, 3-ply  
Wok mit Rost und Deckel, 3-ply  
Wok avec grille et couvercle, 3-ply  
Wok con rejilla y tapa, 3-ply

art.	Ø cm.	h.
12529-32	32	8



**Steel wok pan**

Wok, ferro  
Wok-Eisenpfanne  
Poêle chinoise, acier  
Wok, hierro

art.	Ø cm.	h.
11713-32	32	10
11713-40	40	11



**Steel wok pan**

Wok, ferro  
Wok-Eisenpfanne  
Poêle chinoise, acier  
Wok, hierro

art.	Ø cm.	h.
49604-31	30,5	9
49604-36	35,5	11
49604-41	40,5	12



**Non stick wok**

Wok antiaderente  
Wok-Pfanne, nichttafend  
Poêle chinoise, anti-adhérente  
Wok, antiaderente

art.	Ø cm.
49612-30	30,5
49612-33	33,0



**Wok stand, chromed**

Base per wok, cromata  
Fuss für Wokpfanne, verchromt  
Base pour wok, chromée  
Base para Wok, cromada

art.	Ø cm.	h.
49600-00	20-25	5,5



NEW

SS

**Rice steamer shelf**

Supporto per cottura a vapore  
Reis-Dampfer-Fuss  
Étagère à vapeur  
Estante de cocción al vapor

art.	Ø cm.	h.
49653-10	10,0	7,5
49653-12	12,5	7,5
49653-15	15,0	7,5
49653-17	18,0	7,5
49653-20	20,0	7,5



NEW

SS

**Rice steamer shelf**

Supporto per cottura a vapore  
Reis-Dampfer-Fuss  
Étagère à vapeur  
Estante de cocción al vapor

art.	Ø cm.	h.
49652-10	10,0	2,5
49652-12	12,5	2,5
49652-15	15,0	2,5
49652-17	18,0	2,5
49652-20	20,0	2,5

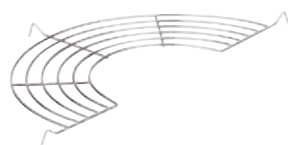

**Tempura rack, chromed**

Griglia per tempura, cromata  
Tempura-Rost, verchromt  
Grille à tempura, chromée  
Rejilla para tempura, cromada

art.	Ø cm.
49613-30	30,5
49613-33	33,0
49613-35	35,5

Flat bottom. – Fondo piano.



NEW

SS

**Steam rack**

Griglia per cottura a vapore  
Dämpf-Rost  
Grille à vapeur  
Rejilla

art.	Ø cm.
49654-15	15,2
49654-20	20,3
49654-25	25,4



NEW

SS

**Dim Sum steam rack**

Griglia Dim Sum  
Dim Sum Dämpf-Rost  
Grille Dim Sum  
Rejilla Dim Sum

art.	Ø cm.
49659-24	24,0
49659-26	26,0



**Steel wok pan**

Wok, ferro  
Wok-Eisenpfanne  
Poêle chinoise, acier  
Wok, hierro

art.	Ø cm.	h.
49605-46	45,5	14,0
49605-61	61,0	18,5
49605-71	71,0	22,0



**Wok lid, aluminum**

Coperchio per wok, alluminio  
Wok-Deckel, Aluminium  
Couverture pour poêle chinoise, alu  
Tapa para wok, aluminio

art.	Ø cm.	h.
49602-25	24,5	4,5
49602-30	29,5	6,2
49602-33	32,0	9,0
49602-35	34,5	10,3



SS

**Wok stand**

Base per wok  
Fuss für Wokpfanne  
Base pour wok  
Base para Wok

art.	Ø cm.
11953-22	22



**Agemono pot and stand**  
Casseruola con supporto  
Kasserolle mit Untersetzer  
Casserole avec support  
Cacerola con soporte

art.	Ø cm.
49655-64	20



**Toban skillet**  
Padella Toban  
Toban-Pfanne  
Poêle Toban  
Sartén Toban

art.	Ø cm.
49655-40	19



**Balti pan**  
Padella balti/karahi  
Balti-Pfanne  
Poêle balti  
Sartén balti

art.	Ø cm.
49657-15	15,2
49657-20	20,3
49657-25	25,4

**Carbon steel.** – Acciaio al carbonio.



**Balti pan with wood base**  
Padella balti base legno  
Balti-Pfanne mit Holz-Basis  
Poêle balti avec base en bois  
Sartén balti base de madera

art.	Ø cm.
49656-02	15,2

**Carbon steel.** – Acciaio al carbonio.



**Steel fry pan**  
Padella per friggere, ferro  
Frittier-Eisenpfanne  
Tuile à frire, acier  
Sartén freidora, hierro

art.	Ø cm.	h.	lt.
41707-32	32	9,8	6,0
41707-36	36	11,0	8,8
41707-40	40	13,4	12,2
41707-45	45	15,0	17,3
41707-50	50	17,6	23,5



**Wire basket, tinned**  
Cestello per friggere, stagnato  
Frittier-Rost, verzinkt  
Grille à frire, étamée  
Cesta escurrefrito, estañada

art.	Ø cm.	h.
41708-32	32	11,0
41708-36	36	11,5
41708-40	40	12,4
41708-45	45	15,5
41708-50	50	16,5



**Japanese omelettes pan, non-stick**  
Padella omelette, antiaderente  
Japanische Omelette Pfanne mit Antihftbeschichtung  
Poêle à omelettes, revêtement anti-adhésif  
Sartén antiaderente para tortillas japonesas

art.	dim. cm.
49655-38	22x24x3,5



**NEW**



**Tamagoyaki pan**  
Padella Tamagoyaki  
Tamagoyaki-Pfanne  
Poêle à Tamagoyaki  
Sartén Tamagoyaki

art.	dim. cm.
49655-66	18x15x3



**Steel tawa pan**

Padella tawa, ferro  
Tawa-Eisenpfanne  
Poêle tawa, acier  
Sartén tawa, hierro

art. Ø cm.  
49614-28 28

**Used in Indian cooking, for chapattis and anything that needs quick cooking at high temperatures.** – Utilizzate nella cucina indiana, per focacce e tutto ciò che ha bisogno di cottura rapida ad alta temperatura.



SS

**Steamer**

Cuocivapore  
Dampf-Kocher  
Cuisneur à vapeur  
Cuscusera

art.	Ø cm.	h.
49606-51	51	14
49606-00	51	14
49606-01	51	20



**Scoop**

Porzionatore  
Portionierer  
Cuiller  
Racionador

art.  
49616S01  
49616B01



**Chinese hot pot, aluminium**

Pentola cinese, alluminio  
Chinese-Suppentopf, Alu  
Marmite chinoise, alu  
Olla chino, aluminio

art.	Ø cm.	h.
49616-22	22	17
49616-24	24	20
49616-26	26	22



**Clay pot**

Casseruola terracotta  
Tontopf  
Pot d'argile  
Olla de barro

art.	Ø cm.	h.	Kg.
49632-24	23	10	1,5
49632-32	32	16	2,7



**Clay pot**

Casseruola terracotta  
Tontopf  
Pot d'argile  
Olla de barro

art.	Ø cm.	h.	Kg.
49633-22	22	10	0,75
49633-24	24	12	1,35



**Cast iron sizzler platter with wood**

Piatto ghisa con vassoio legno  
Gusseisenplatte mit Holzbrett  
Plat en fonte avec planche bois  
Fuente hierro fundido con tabla madera

art.	dim. cm.
49615-01	33,5x22



**Cast iron sizzler platter with wood**

Piatto ghisa con vassoio legno  
Gusseisenplatte mit Holzbrett  
Plat en fonte avec planche bois  
Fuente hierro fundido con tabla madera

art.	dim. cm.
44223S19	12,5x19



**Mortar and pestle**

Mortaio e pestello  
Mörser und Stößel  
Mortier et pilon  
Mortero y pistilo

art.	Ø cm.	h.	Kg.
49618-12	12,5	9,0	1,9
49618-15	15,0	10,0	3,2
49618-18	17,0	11,5	3,9



**Wasabi grater**

Grattugia per wasabi  
Wasabi-Raffel  
Rape à wasabi  
Rallador para wasabi

art.	dim. cm.
42555-11	11x7,5



SS

**Oil pourer**

Oliera  
Ölkanne  
Huilière  
Alcuza

art.	ml.
41780-05	500
41780-07	750
41780-09	1000



**Wonton noodle skimmer**

Schiumarola Wonton  
Wonton-Sieb  
Ecumoire à Wonton  
Colador para Wonton

art.	Ø cm.	h.
49601-14	14	13

**Stainless steel and natural wood.**  
Inox e legno naturale.



**Chinese kitchen scissors**

Forbici cucina cinesi  
Chinesische Küchenschere  
Ciseaux de cuisine chinois  
Tijeras de cocina china

art.	dim. cm.
49636-00	17x8,5

**Stainless steel and brass. –** Inox e ottone.



**Duck fur pincer**

Pinza per anatra  
Ente Fell Zange  
Pince à canard  
Pinza pato

art.	l. cm.
49637-00	15



**Fish scaler**

Squamapesce  
Fischentschupper  
Ecailleur à poisson  
Escamador

art.	l. cm.
49638-00	22



**Fry basket, coarse mesh**

Schiumarola fritto, rete grossa  
Frittierkorb  
Panier de friture  
Cesta para freír

art.	Ø cm.
49607-15	15,0
49607-20	20,0
49607-25	25,5
49607-30	30,5

**Bamboo handle, stainless steel mesh.**  
Manico bamboo, rete inox.



**Fry basket, fine mesh**

Schiumarola fritto, rete fine  
Frittierkorb  
Panier de friture  
Cesta para freír

art.	Ø cm.
49608-15	15,0
49608-20	20,0
49608-25	25,5
49608-30	30,5
49608-35	35,5

**Bamboo handle, stainless steel mesh.**  
Manico bamboo, rete inox.



SS

**Skimmer**

Schiumarola  
Schaumlöffel  
Ecumoire  
Espumadera

art.	Ø cm.	l. cm.
49617-23	24	45
49617-25	26	46
49617-30	30	50



**Ladle**

Mestolo  
Schöpflöffel  
Louche  
Cacillo

art.	Ø cm.
49609-12	11,8
49609-14	13,8

**Stainless steel and natural wood.**  
Inox e legno naturale.



**Spatula**

Paletta  
Teigschäber  
Spatule  
Espátula

art.	dim. cm.
49610-11	11x10,2
49610-14	13,3x12

**Stainless steel and natural wood.**  
Inox e legno naturale.



B

**Cooking chopsticks**

Bastoncini per cucinare  
Kochstäbchen  
Baguettes de cuisine  
Palillos para cocinar

art.	l. cm.
49629-45	45

**Disposable. – Monouso.**



B

**Wok brush**

Pennello per wok  
Wok-Pinsel  
Pinceaux à wok  
Pincel para wok

art.	l. cm.
49634-00	25,5



**Wooden handled wok brush**

Spazzola per wok  
Wok-Bürste, Holzgriff  
Brosse à wok, manche bois  
Cepillo para wok, mango madera

art.	l. cm.
49635-00	27,5



# PIZZA

ETHNIC CUISINE  
CUCINA ETNICA







SS

**Oil pourer**

Oliera  
Ölkanne  
Huilière  
Alcuza

art.	lt.
41780-05	0,50
41780-07	0,75
41780-09	1,00



**Oil pourer, copper**

Oliera, rame  
Ölkanne, Kupfer  
Huilière, cuivre  
Alcuza, cobre

art.	h. cm.	lt.
41781-05	23,0	0,50
41781-10	27,0	1,00
41781-15	31,5	1,50

Tinned inside. – Interno stagnato.



**Pizza peel, aluminum**

Pala pizza, alluminio  
Pizzaschaufel, Aluminum  
Pelle à pizza, aluminum  
Pala pizza, aluminio

art.	Ø cm.	l. cm.	gr.
11701-02	32	150	736
11701-06	37	150	870
11701-10	41	150	1226
11701-13	45	150	1460
11701-16	50	150	1604



**Pizza peel, aluminum**

Pala pizza, alluminio  
Pizzaschaufel, Aluminum  
Pelle à pizza, aluminum  
Pala pizza, aluminio

art.	cm.	l. cm.	gr.
11702-02	32x32	150	784
11702-06	37x37	150	894
11702-10	41x41	150	1246
11702-16	50x50	150	1694



**Perforated pizza peel, aluminum**

Pala pizza forata, alluminio  
Pala pizza forata, alluminio  
Pizzaschaufel, gelocht, Aluminum  
Pelle à pizza perforée, aluminum  
Pala pizza perforada, aluminio

art.	cm.	l. cm.	gr.
11704-02	32x32	150	700
11704-06	37x37	150	816
11704-13	45x45	150	1250
11704-16	50x50	150	1409



SS

**Pizza peel, small**

Palettino  
Pizzaschaufel, klein  
Petite pelle à pizza  
Pala pizza, pequeña

art.	Ø cm.	l. cm.	gr.
11705-02	17	150	780
11705-06	20	150	846
11705-10	23	150	938
11705-14	26	150	984



SS

**Perforated pizza peel, small**

Palettino forato  
Pizzaschaufel, gelocht, klein  
Petite pelle à pizza perforée  
Pala pizza perforada, pequeña

art.	Ø cm.	l. cm.	gr.
11706-02	17	150	770
11706-06	20	150	830
11706-10	23	150	912
11706-14	26	150	954



**Oven pizza peel, aluminum**

Pala per infornare, alluminio  
Back-Pizzaschaufel, Aluminum  
Pelle à enfourner, aluminum  
Pala para hornear, aluminio

art.	cm.	l. cm.	gr.
41765-32	32x32	150	1200
41765-37	37x37	150	1400
41765-41	41x41	150	1500
41765-45	45x45	150	1600
41765-50	50x50	150	1700



SS

**Oven pizza peel**

Pala per infornare  
Back-Pizzaschaufel  
Pelle à enfourner  
Pala para hornear

art.	Ø cm.	l. cm.	gr.
41735-29	29	150	870

Aluminum handle. – Manico alluminio.



**Oven pizza peel, aluminum**

Pala per infornare, alluminio  
Back-Pizzaschaufel, Aluminium  
Pelle à enfourner, aluminium  
Pala para hornear, aluminio

art.	cm.	l. cm.	gr.
41736-32	32x30	150	954



SS

**Perforated pizza peel, small**

Palettino forato  
Pizzaschaufel, gelocht, klein  
Petite pelle à pizza perforée  
Pala pizza perforada, pequeña

art.	Ø cm.	l. cm.	gr.
41737-17	17	150	890
41737-20	20	150	910
41737-23	23	150	960



SS

**Pizza peel, small**

Palettino  
Pizzaschaufel, klein  
Petite pelle à pizza  
Pala pizza, pequeña

art.	Ø cm.	l. cm.	gr.
41738-17	17	150	905
41738-20	20	150	975
41738-23	23	150	1030



**Pizza peel, small, aluminum**

Palettino, alluminio  
Pizzaschaufel, klein, Aluminium  
Petite pelle à pizza, aluminium  
Pala pizza, pequeña, aluminio

art.	Ø cm.	l. cm.	gr.
41735-20	20	150	800



W

**Pizza peel**

Pala pizza  
Pala pizza  
Pizzaschaufel  
Pelle à enfourner  
Pala pizza

art.	Ø cm.	l. cm.
41764-28	28	125
41764-33	33	200
41764-40	40	200



SS

**Ash shovel**

Paletta cenere  
Asche-Schaufel  
Pelle à cendres  
Paleta recogedar cenizas

art.	cm.	l. cm.
41768-21	21x31	173



SS

**Rake**

Rastrello  
Harke  
Râteau  
Rastrillo

art.	cm.	l. cm.
41768-22	24x10	150



**Adjustable brush**

Spazzola orientabile  
Drehbare Bürste  
Brosse orientable  
Cepillo orientable

art.	cm.	l. cm.
41767-20	20x6,5	155

**Brass bristles. – Setole ottone.**



**Adjustable brush**

Spazzola orientabile  
Drehbare Bürste  
Brosse orientable  
Cepillo orientable

art.	cm.	l. cm.
41766-27	27x7	150

**Brass bristles. – Setole ottone.**



**Adjustable brush**

Spazzola orientabile  
Drehbare Bürste  
Brosse orientable  
Cepillo orientable

art.	cm.	l. cm.
41766-16	16x5	150

**Brass bristles. – Setole ottone.**



**Adjustable brush**

Spazzola orientabile  
Drehbare Bürste  
Brosse orientable  
Cepillo orientable

art.	cm.	l. cm.
41766-14	14x7	150



**Adjustable brush**

Spazzola orientabile  
Drehbare Bürste  
Brosse orientable  
Cepillo orientable

art.	cm.	l. cm.
41739-20	20x6,6	150



**Brush for grill cleaning**

Spazzola per griglia, setole in acciaio  
Grillenbürste mit Stahlborsten  
Brosser pour grille avec soies en acier  
Cepillo para parrilla con cerdas de acero

art. cm.  
41740-00 27x4x15



SS

**Support for peels**

Poggia pala pizza  
Schaufelträger  
Support pour pelles à pizza  
Portapala para palas

art. cm. Kg.  
41769-36 41x16x39 3,0  
41769-50 53x16x39 3,5



**Small pizza peel wall rack, aluminum**

Portapaleto da muro, alluminio  
Pizzaschaufel-Wandgestell, Aluminum  
Support mural petite pelle, aluminum  
Soporte mural de pala pizza, aluminio

art.  
41769-02



**Pizza peel wall rack, aluminum**

Appendi pala da muro, alluminio  
Pizzaschaufel-Wandgestell, Aluminum  
Support mural pour pelle, aluminum  
Soporte mural de pala pizza, aluminio

art.  
41769-01



**Double-sided brush**

Spazzola bi-facciale  
Bürste Deidseitig  
Brosse double face  
Cepillo doble

art. l. cm.  
41761-02 100



SS

**Pizza peel rack**

Porta pale  
Ständer für Schaufeln  
Support pour pelles  
Soporte para pala

art. h. cm. Kg.  
41769-00 172 14



SS

**Pizza peel, marble base**

Porta pale, base marmo  
Ständer für Schaufeln  
Support pour pelles  
Soporte para pala

art. cm.  
41769G00 25x35x180

Supplied WITHOUT peels. – Fornito SENZA pale.



SS

**Adjustable brush**

Spazzola orientabile  
Drehbare Bürste  
Brosse orientable  
Cepillo orientable

art. cm. l. cm.  
41767G20 20x6 160

Brass bristles. – Setole ottone.



SS

**Pizza peel, aluminum**

Pala pizza, alluminio  
Pizzaschaufel, Aluminum  
Pelle à pizza, aluminum  
Pala pizza, aluminio

art. cm. l. cm.  
41704G33 33x33 150  
41704G36 36x36 150



SS

**Perforated pizza peel, small**

Palettino forato  
Pizzaschaufel, gelocht, klein  
Petite pelle à pizza perforée  
Pala pizza perforada, pequeña

art.	Ø cm.	l. cm.
41737G20	20	150
41737G23	23	150



SS

**Pan gripper**

Pinza per teglie  
Pizzablech-Zange  
Pince à plaques  
Pinza fuente horns

art.	l. cm.
42822-00	23



SS

**Pan gripper**

Pinza per teglie  
Pizzablech-Zange  
Pince à plaques  
Pinza fuente horns

art.	l. cm.
18323-00	23



SS

**Pizza cutter**

Tronchetto tagliapizza  
Pizzaschneider  
Coupe-pizza  
Cortador de pizza

art.	Ø cm.	l. cm.
18324-00	13,5	19



SS

**Divisible pizza scissors**

Forbice pizza smontabile  
Pizzaschere, teilbar  
Ciseaux à pizza, divisible  
Tijeras para pizza desmontables

art.	l. cm.
18276-00	25



SS

**Pizza wheel**

Rotella taglia pizza  
Pizzaschneider  
Roulette à pizza  
Ruleta cortapizzas

art.	Ø cm.
18324-10	10



SS

**Pizza knife**

Coltello per pizzaiolo  
Pizzamesser  
Couteau à pizza  
Cuchillo para pizza

art.	l. cm.
48280-45	23



SS

**Farinata knife**

Coltello per farinata  
Farinata Messer  
Couteau à farinata  
Cuchillo farinata

art.	l. cm.
42830-08	8



SS

**Perforated spatula**

Paletta triangolare, forata  
Palette, gelocht  
Palette perforée  
Pala triangular perforada

art.	cm.
18301-01	12x15



SS

**Spatula**

Paletta triangolare  
Palette  
Palette  
Pala triangular

art.	cm.
18301-02	12x15



**Peel with handle, aluminum**

Pala manicata, alluminio  
Schaufel mit Griff, Aluminum  
Pelle avec manche, alu  
Pala con mango, aluminio

art.	Ø cm.
42826-32	32
42826-37	37



SS

**Perforated peel with handle**

Pala manicata, forata  
Schaufel mit Griff, gelocht  
Pelle perforée avec manche  
Pala con mango, perforada

art.	cm.
18302-01	22x18



SS

**Peel with handle**  
Pala manicata  
Schaufel mit Griff  
Pelle avec manche  
Pala con mango

art.	cm.
18302-02	22x18



W

**Round platter**  
Vassoio rotondo  
Buchenholzbrett, rund  
Plateau rond  
Bandeja redonda

art.	Ø cm.	h. cm.
41774-33	33	1,2

**Beech wood.** – Faggio.



W

**Cutting board 1 portion**  
Tagliere monoporzione  
Einzelportion Tablett  
Planche mono-portion  
Tabla monoporción

art.	cm.
41775-34	34x20x1,2

**Beech wood.** – Faggio.



MF

**Round platter**  
Vassoio rotondo  
Tablett, rund  
Plateau rond  
Bandeja redonda

art.	Ø cm.	h. mm.
44473-02	33	0,8
44473-03	43	0,8



W

**Round platter**  
Tagliere rotondo  
Holzbrett, rund  
Plateau rond  
Tabla redonda

art.	cm.
44260-30	30x43x1,8
44260-34	34x47x1,8

**Iroko wood.** – Iroko.



W

**Pizza plate with wooden platter**  
Piatto pizza con tagliere legno  
Pizzaplatte mit Holzbrett  
Plat à pizza avec planche bois  
Fuente pizza con tabla madera

art.	Ø cm.
44233-16	16
44233-20	20

**Cups not included.** – Ciotoline non incluse.



W

**Pizza plate with wooden platter**  
Piatto pizza con tagliere legno  
Pizzaplatte mit Holzbrett  
Plat à pizza avec planche bois  
Fuente pizza con tabla madera

art.	Ø cm.
44232S12	12
44232S16	16
44232S20	20

**Enamelled cast iron plate.** – Piatto in ghisa smaltata.

**PIZZA SYSTEM**

The modular system where the base and lid are the same element. Rotation system allows the steam of hot pizzas to escape.

Sistema modulare, la base e coperchio sono lo stesso elemento. Dotato di sistema rotabile, per la fuoriuscita del vapore delle pizze calde.



**Base and lid**  
Base e coperchio  
Basis und Abdeckung  
Base et couvercle  
Base y tapa

art.	cm.
44975-35	41x41x7,5
44975-50	57x57x9,5



**Extender**  
Estensore  
Aufsatz  
Réhausse  
Extensión

art.	cm.
44975H35	41x41x7,5
44975H50	57x57x9,5

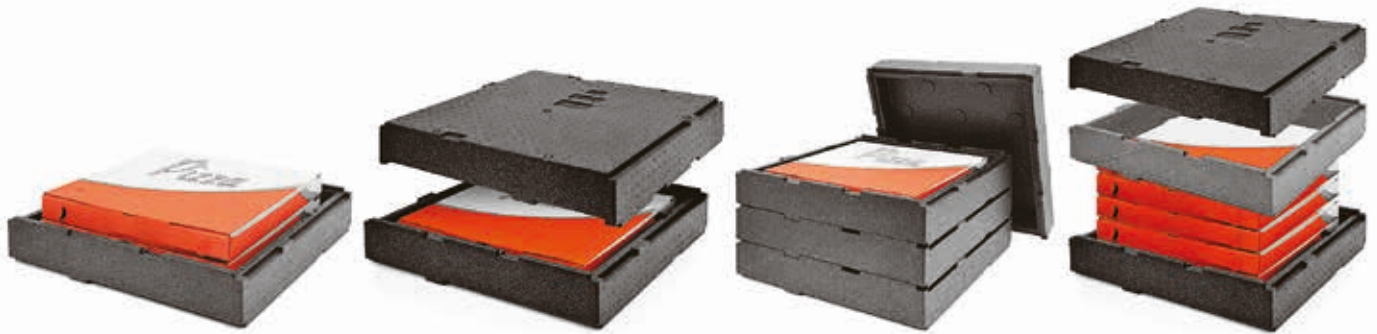

**Insulated container**  
Contentore isothermico  
Thermobehälter  
Conteneur isotherme  
Contenedor isotérmico

art.	cm.	lt.
44961-03	42x42x34,5	36

**With steam release system. For pizza boxes max 36x36 cm.** – Con sistema di rilascio del vapore. Per cartoni pizza max 36x36 cm.



**Insulated container with handle**  
Contentore isothermico con maniglia  
Thermobehälter mit Grill  
Conteneur isotherme avec manche  
Contenedor isotérmico con asa

art.	cm.	lt.
44961M03	42x42x34,5	36



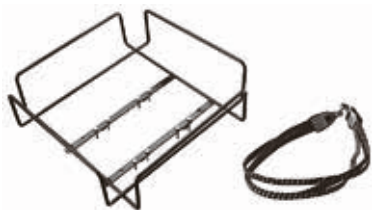

NEW

**Bike basket rack + elastic hook**

Cestello portapacco bike + gancio elastico  
Fahrradträgerkorb + elastischer Haken  
Porte-panier pour vélos + crochet élastique  
Canasta para bicicletas + gancho elástico

art. cm.  
44962-01 46x46x16

**With 8 self-locking screws. Max platform capacity 25 kg.** – Completo di 8 viti autobloccanti. Portata massima pianale 25 kg.



NEW

**Pizza delivery bag**

Borsa isotermica  
Thermo-Tasche  
Sac thermique  
Bolsa térmica

art. cm. cap.  
44960-01 55x50x20 3xø45



**Pizza delivery bag**

Borsa isotermica  
Thermo-Tasche  
Sac thermique  
Bolsa térmica

art. cm. cap.  
44960-04 46x44x20 4xø30



NEW

**Pizza delivery bag**

Borsa isotermica  
Thermo-Tasche  
Sac thermique  
Bolsa térmica

art. cm. cap.  
44960-06 34x34x19.5xø33  
44960-07 42x42x19.4xø40



NEW

**Pizza delivery bag**

Borsa isotermica  
Thermo-Tasche  
Sac thermique  
Bolsa térmica

art. cm. cap.  
44960-02 46x46x12.2xø40  
44960-03 50x51x11.2xø45



NEW

**Sandwich delivery bag**

Borsa isotermica  
Thermo-Tasche  
Sac thermique  
Bolsa térmica

art. cm.  
44960-13 39x27x30

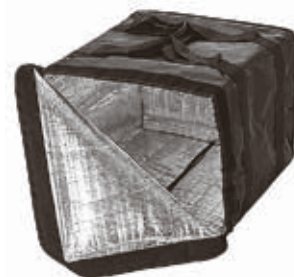

NEW

**Pizza delivery bag**

Borsa isotermica  
Thermo-Tasche  
Sac thermique  
Bolsa térmica

art. cm.  
44960-10 51x46x41



NEW

**Pizza delivery bag**

Borsa isotermica  
Thermo-Tasche  
Sac thermique  
Bolsa térmica

art. cm.  
44960-11 48x48x70



**NEW**

**Pizza delivery bag with rack**  
Borsa isotermitica con rastrelliera  
Thermo-Tasche mit Gestell  
Sac thermique avec étagère  
Bolsa térmica con rack

art. cm. cap.  
44960K10 51x46x41 6xø45



**NEW**

**Pizza delivery bag with rack**  
Borsa isotermitica con rastrelliera  
Thermo-Tasche mit Gestell  
Sac thermique avec étagère  
Bolsa térmica con rack

art. cm. cap.  
44960K11 48x48x70 10xø45



**NEW**

**Pizza delivery backpack**  
Zaino isotermitico  
Thermo-Rucksack  
Sac à dos thermique  
Mochila térmica

art. cm.  
44962-05 45x45x38

**Polyester and nylon. With inner PP insulataed container. For pizza boxes up to 35x35 cm. – Poliestere e nylon. Interno con contenitore isotermitico in PP. Per scatole pizza fino a 35x35 cm.**



**PP**  
**SS**

**Dough scraper, flexible**  
Tagliapasta flessibile  
Abstecher, flexibel  
Raclette flexible  
Cortapastas flexible

art. cm.  
18501-02 12x9,5



**PP**  
**SS**

**Dough scraper**  
Tagliapasta  
Abstecher  
Raclette  
Cortapastas

art. cm.  
18501-01 12x16  
18501-03 13,5x10  
18501-04 12x9,5



**PP**  
**SS**

**Dough scraper**  
Raschia  
Teigschäber  
Raclette  
Rasqueta

art. cm.  
18501-05 11x19,5





PP  
SS

**Dough scraper**

Raschia  
Teigschäber  
Raclette  
Rasqueta

art. cm.  
18502-18 18x9



PP  
SS

**Dough scraper**

Raschia  
Teigschäber  
Raclette  
Rasqueta

art. cm.  
18503-12 12x10



PP  
SS

**Dough scraper**

Raschia  
Teigschäber  
Raclette  
Rasqueta

art. cm.  
18504-15 15x7,5



PP  
SS

**Dough scraper**

Raschia  
Teigschäber  
Raclette  
Rasqueta

art. cm.  
18520-15 15x6



PA+  
plus

**Pizza ladle, flat bottom**

Mestolo pizza, fondo piatto  
Schöpflöffel, flachboden  
Louche fond plat  
Cacillo fondo plano

art. Ø cm. l. cm.  
12968-10 10 27



PS

**Dough cutter**

Tagliapasta  
Teigschäber  
Raclette  
Rascador

art. cm.  
47621-11 10x24

**Shock and scratchproof material. Do not use on heat sources.** – Materiale antiurto e antigraffio. Non usare su fonti di calore.



PS

**Dough cutter**

Tagliapasta  
Teigschäber  
Raclette  
Rascador

art. cm.  
47621-12 13,5x14,5

**Shock and scratchproof material. Do not use on heat sources.** – Materiale antiurto e antigraffio. Non usare su fonti di calore.



PE

**Dough box**

Contenitore per impasti  
Behälter für Pizzateig  
Récipient à pétrissage  
Contenedor para masa de pizza

art. cm. lt.  
41762-07 60x40x7,5 14  
41762-09 60x40x9,5 19  
41762-13 60x40x13 26



PE

**Cover for dough box**

Coperchio per contenitore  
Deckel für Pizzateig-Behälter  
Couvercle pour récipient à pétrissage  
Tapa para contenedor

art. cm.  
41763-00 60x40



**Pizza screen, aluminum**  
Retina pizza, alluminio  
Pizzanetzscheibe, Aluminum  
Toile à pizza, aluminium  
Red para pizza, aluminio

art.	cm.
41734-60	60x40



**Pizza screen, aluminum**  
Retina pizza, alluminio  
Pizzanetzscheibe, Aluminum  
Toile à pizza, aluminium  
Red para pizza, aluminio

art.	Ø cm.
41727-28	28
41727-30	30
41727-33	33
41727-36	36
41727-40	40

**Without seam. – Senza giunzione.**



**Pizza screen, aluminum**  
Retina pizza, alluminio  
Pizzanetzscheibe, Aluminum  
Toile à pizza, aluminium  
Red para pizza, aluminio

art.	Ø cm.
41727-45	45
41727-50	50
41727-55	55
41727-60	60

**Without seam. – Senza giunzione.**



**SS**

**Pizza screen rack**  
Rastrelliera per retine  
Pizzanetzscheiben-Träger  
Etagère à toiles  
Rack para red para pizza

art.	cm.
41771-96	23x35,6

**Suitable for 96 screens. – Può contenere 96 retine.**



**SS**

**Pizza pan rack**  
Rastelliera per teglie pizza  
Pizzableche-Träger  
Etagère pour plaques à pizza  
Rack para placas pizza

art.	cm.
41770-15	30,5x30,5x70

**Rails h.3,5 cm. for sheets up to Ø 36 cm.**  
Distanza piani cm 3,5, per teglie max ø 36 cm.



**Baking tray, alusteel**  
Teglia forno, acciaio alluminato  
Backblech mit Aluminiumüberzug  
Plaque à pizza, tôle aluminée  
Placa pizza, acero aluminizado

art.	Ø cm.	h. cm.	U. Pack
11739-20	20	2,5	10
11739-24	24	2,5	10
11739-28	28	2,5	10
11739-32	32	2,5	10



**Pizza pan, heavy blue steel**  
Teglia pizza, ferro blu pesante  
Pizzablech, Blaublech, Schwerausführung  
Plaque à pizza, tôle forte bleuie  
Placa pizza, hierro pesante

art.	Ø cm.	h. cm.	U. Pack
11744-20	20	2,5	10
11744-24	24	2,5	10
11744-28	28	2,5	10
11744-32	32	2,5	10

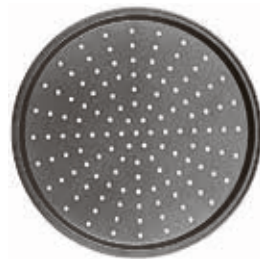

**Pizza pan, perforated, non stick coated**  
Teglia pizza forata, antiaderente  
Pizzablech, gelocht, beschichtet  
Plaque à pizza perforée, anti-adhésive  
Placa pizza perforada, antiaderente

art.	Ø cm.	h. cm.
41729-30	30	1,3
41729-34	34	1,3



**Pizza pan double non stick-coating**  
Teglia pizza, antiaderente a 2 strati  
Pizzablech mit Doppel-Beschichtung  
Plaque à pizza, double revêtement  
Placa pizza antiaderente, 2 capas

art.	Ø cm.	h. cm.	U. Pack
11741-20	20	2,5	5
11741-24	24	2,5	5
11741-26	26	2,5	5
11741-28	28	2,5	5
11741-32	32	2,5	5

**Heat resistant up to 280°C. – Resistente a 280 °C.**



**Pizza pan, blue steel**

Teglia pizza, ferro blu  
Pizza-Blaublech  
Plaque à pizza, tôle bleuie  
Placa pizza, hierro

art.	Ø cm.	h. cm.	U. Pack
11740-14	14	2,5	5
11740-16	16	2,5	5
11740-18	18	2,5	5
11740-20	20	2,5	5
11740-22	22	2,5	5
11740-24	24	2,5	5



**Pizza pan, blue steel**

Teglia pizza, ferro blu  
Pizza-Blaublech  
Plaque à pizza, tôle bleuie  
Placa pizza, hierro

art.	Ø cm.	h. cm.	U. Pack
11740-26	26	2,5	5
11740-28	28	2,5	5
11740-30	30	2,5	5
11740-32	32	2,5	5
11740-36	36	2,5	5
11740-40	40	2,5	5



**Pizza pan, blue steel**

Teglia pizza, ferro blu  
Pizza-Blaublech  
Plaque à pizza, tôle bleuie  
Placa pizza, hierro

art.	Ø cm.	h. cm.	U. Pack
11742-16	16	3,5	10
11742-18	18	3,5	10
11742-20	20	3,5	10
11742-22	22	3,5	10
11742-24	24	3,5	10
11742-26	26	3,5	10
11742-28	28	3,5	10



**Pizza pan, blue steel**

Teglia pizza, ferro blu  
Pizza-Blaublech  
Plaque à pizza, tôle bleuie  
Placa pizza, hierro

art.	Ø cm.	h. cm.	U. Pack
11742-30	30	3,5	10
11742-32	32	3,5	5
11742-36	36	3,5	5
11742-40	40	3,5	5
11742-45	45	4,0	5
11742-50	50	4,0	5
11742-60	60	4,0	5



**Baking tray, blue steel, rectangular**

Teglia rettangolare, ferro blu  
Blaublech, rechteckig  
Plaque rectangulaire, tôle bleuie  
Placa rectangular, hierro

art.	cm.	h. cm.
41745-30	30x23	3
41745-35	35x28	3
41745-40	40x30	3
41745-50	50x35	3
41745-60	60x40	3
41745-65	65x45	3



**Baking tray, alusteel**

Teglia, alluminata  
Backblech, Aluminumüberzug  
Plaque rectangulaire, tôle aluminitée  
Placa rectangular, acero aluminizado

art.	cm.	h. cm.
41746-60	60x40	2





**Baking tray, alusteel**

Teglia, alluminata  
Backblech, Aluminiumüberzug  
Plaque rectangulaire, tôle aluminitée  
Placa rectangular, acero aluminizado

art.	cm.	h. cm.
41751-30	30x23	3
41751-35	35x28	3
41751-40	40x30	3
41751-50	50x35	3
41751-60	60x40	3
41751-65	65x45	3



**Baking tray, aluminum**

Teglia, alluminio  
Backblech, Aluminium  
Plaque à cuisson, aluminium  
Placa pastelería, aluminio

art.	cm.	GN	h. cm.
41744-32	32,5x53	1/1	1
41744-53	53x65	2/1	1
41744-60	60x40	-	1



**Baking tray, aluminum, perforated**

Teglia forata, alluminio  
Backblech, gelocht, Aluminium  
Plaque perforée, aluminium  
Placa perforada, aluminio

art.	cm.	h. cm.
41756-30	30x40	1
41756-32	32,5x53	1
41756-53	53x65	1
41756-60	60x40	1

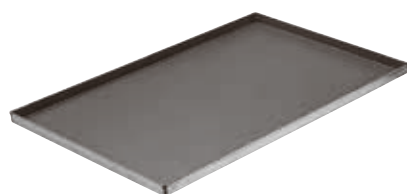

**Baking tray, non stick coated**

Teglia antiaderente  
Blech mit Antihftbeschichtung  
Plaque avec revêtement anti-adhésif  
Placa antiaderente

art.	cm.	h. cm.
41747-60	60x40	2



**Baking tray, non stick coated**

Teglia antiaderente  
Blech mit Antihftbeschichtung  
Plaque avec revêtement anti-adhésif  
Placa antiaderente

art.	Ø cm.	GN	pcs/pz
41755-11	12,5	1/1	6



**Baking tray, non stick coated**

Teglia antiaderente  
Blech mit Antihftbeschichtung  
Plaque avec revêtement anti-adhésif  
Placa antiaderente

art.	cm.	GN	h. cm.
41743-32	32,5x53	1/1	1
41743-53	53x65	2/1	1
41743-60	60x40	-	1



**Baking tray, perforated, non stick coated**

Teglia forata, antiaderente  
Blech, gelocht mit Antihftbeschichtung  
Plaque perforée, revêtement anti-adhésif  
Placa perforada, antiaderente

art.	cm.	GN	h. cm.
41753-30	30x40	-	1
41753-32	32,5x53	1/1	1
41753-53	53x65	2/1	1
41753-60	60x40	-	1



**Baking tray, alusteel**

Teglia, alluminata  
Backblech, Aluminiumüberzug  
Plaque, tôle aluminitée  
Placa, acero aluminizado

art.	Ø cm.	cm.	pcs/pz
41752-08	14	60x40	8
41752-12	12	60x40	12
41752-24	12	60x80	24



# COFFEE SHOP CAFFETTERIA

BAR HAPPY HOUR





**Nitro Whip**  
Sifone nitro  
Nitrobereiter  
Siphon à nitro  
Sifón para Nitro

art.	lt.	des.
41452N10	1	Whip/Sifone
41452N16	-	16 chargers/ricariche

**Nitro Brew is on one of the fastest growing trends in the coffee business. Offer Nitro Coffee, Nitro Tea, and Nitro Cocktails to delight your guests table/barside. Adding Nitrogen (N2) to cold brew coffee and cocktails initiates a spectacular cascading effect, making the beverage unique, attractive, and personal. Nitrogen creates a velvety creamy texture and a long lasting foamy head for brews and cocktails.** – Infusi Nitro è una delle tendenze in rapida crescita nel settore del caffè. Offri Nitro Caffè, Nitro Te e Nitro Cocktails per deliziare i tuoi ospiti. Aggiungendo l'azoto (N2) per preparare caffè e cocktail a freddo, viene avviato uno spettacolare effetto a cascata, rendendo la bevanda unica, attraente e personale. L'azoto crea una consistenza vellutata e cremosa e una spuma di lunga durata per infusi e cocktail.



**Set of 10 stencils, plastic**  
Kit 10 mascherine, plastica  
Satz 10 Masken, kunststoff  
Set 10 pcs masques, plastique  
Juego 10 máscaras, plástico

art.	Ø cm.	h. cm.	lt.
47859-01	10	16	0,25



**Set of 10 stencils, plastic**  
Kit 10 mascherine, plastica  
Satz 10 Masken, kunststoff  
Set 10 pcs masques, plastique  
Juego 10 máscaras, plástico

art.	Ø cm.
47859-02	10



**Set of 4 stencils, plastic**  
Kit 4 mascherine, plastica  
Satz 4 Masken, kunststoff  
Set 4 pcs masques, plastique  
Juego 4 máscaras, plástico

art.	Ø cm.
47859-03	10



**Cocoa duster kit**  
Kit spargicacao  
Kakaostreuer-Set  
Set glacière à cacao  
Juego dosificador cacao

art.	Ø cm.	h. cm.
42923-07	6,5	13



**Cocoa dredger**  
Spargicacao  
Kakaostreuer  
Saupoudreuse  
Especiero

art.	Ø cm.	h. cm.	ml.
41607-00	5,5	7,5	160



**Sugar pourer**  
Spargizucchero  
Zuckerstreuer  
Saupoudreuse  
Especiero

art.	Ø cm.	Ø mm.	ml.
47023-01	7	1,5	300
47023-02	7	2,5	300
47023-03	7	5	300
47023-04	7	mesh	300



**Sugar pourer**  
Spargizucchero  
Zuckerstreuer  
Sucrier  
Dispensador azúcar

art.	Ø cm.	h. cm.	ml.
41525-01	8	15	250



**Sugar pourer**  
Spargizucchero  
Zuckerstreuer  
Sucrier  
Dispensador azúcar

art.	Ø cm.	h. cm.	ml.
42920-02	7,5	13,5	320



**Sugar pourer**  
Spargizucchero  
Zuckerstreuer  
Sucrier  
Dispensador azúcar

art.	Ø cm.	h. cm.	ml.
41645-00	7,5	17	320



**Honey/cream dispenser**  
Dosatore miele/cremiera  
Sahne-/Honigkännchen  
Doseur pour miel/lait  
Dosificador para miel/leche

art.	Ø cm.	h. cm.	ml.
41525-00	8,5	13,5	300



**Milk frothing thermometers, 3 pcs**  
Termometri latte/barista, 3 pz  
Mich-Thermometer, 3 Stk  
Thermomètres à lait, 3 pièces  
Termómetros leche, 3 pz

art.	Ø cm.	scala	range
49709-03	4,5	1°C	-10+110°C

**Red, green and blue, to easily identify different types of milk used, to avoid cross-contamination. Stem 175 mm.** – Rosso, verde e blu, per identificare facilmente i diversi tipi di latte utilizzati, per evitare la contaminazione incrociata. Stelo 175 mm.





SS

**Milk pot with lid**

Lattiera con coperchio  
Milchgießer mit Deckel  
Pot à lait avec couvercle  
Jarra leche con tapa

art.	lt.
66303-01	0,15
66303-03	0,30
66303-06	0,60



SS

**Cappuccino milk pot**

Lattiera cappuccino  
Capuccino-Milchkanne  
Pot à cappuccino  
Jarra cappuccino

art.	lt.
66307-06	0,6
66307-09	0,9
66307-12	1,2



SS

**Spoon holder**

Porta cucchiaini  
Kaffeelöffelbehälter  
Porte cuillères  
Porta cucharas

art.	Ø cm.	h. cm.
66313-03	6	9



SS

**Straw holder**

Porta cannuce  
Röhrchenbehälter  
Porte chalumeaux  
Porta canutillos

art.	Ø cm.	h. cm.
66313-06	8	12



SS

**Sugar packet holder**

Portabustine zucchero  
Zuckertütenschale  
Conteneur à sucre  
Contenedor sobres azúcar

art.	dim. cm.
66374-00	13x6x4



SS

**Sugar packet holder**

Portabustine zucchero  
Zuckertütenschale  
Conteneur à sucre  
Contenedor sobres azúcar

art.	dim. cm.
44104-15	9x7,5x5

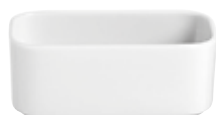

PR

**Sugar packet holder**

Portabustine zucchero  
Zuckertütenschale  
Conteneur à sucre  
Contenedor sobres azúcar

art.	dim. cm.
67303-64	11x6x4



**Sugar packet holder**

Portabustine zucchero  
Zuckertütenschale  
Conteneur à sucre  
Contenedor sobres azúcar

art.	dim. cm.	col.
44104-01	8,5x6,5x5	●
44104-02	8,5x6,5x5	○



AY

**Tea-box**

Scatola portabustine tè  
Teebox  
Boîte à sachets de thé  
Caja para bolsitas de tè

art.	dim. cm.
41614-22	22x17x9



W

**Tea-box**

Scatola portabustine tè  
Teebox  
Boîte à sachets de thé  
Caja para bolsitas de tè

art.	dim. cm.
41614-33	33,5x20x9
41614-35	31x28x9



W

**Tea-box**

Scatola portabustine tè  
Teebox  
Boîte à sachets de thé  
Caja para bolsitas de tè

art.	dim. cm.
41614-34	33,5x20x9
41614-36	31x28x9



NEW

PMMA

**Box With Lid**

Contentitore con coperchio  
Behälter mit Deckel  
Boîte avec couvercle  
Recipiente con tapa

art.	dim. cm.
41472-25	27,5x10,5x9,5

**Single compartment 8,5x8 cm.**  
Singolo compart 8,5x8 cm.





NEW  
PMMA

**Paper napkins holder**

Porta tovaglioli  
Serviettenhalter  
Porte serviettes  
Porta servilletas

art. dim. cm.  
41472-12 18x6x10



NEW  
PMMA

**Paper napkins holder**

Porta tovaglioli  
Serviettenhalter  
Porte serviettes  
Porta servilletas

art. dim. cm.  
41472-13 18x6x11



SS

**Napkin holder**

Portatovaglioli  
Serviettenhalter  
Porte serviettes  
Servilletero

art. dim. cm.  
66391-00 10x3x8



SS

**Napkin holder**

Portatovaglioli  
Serviettenhalter  
Porte serviettes  
Servilletero

art. dim. cm.  
41602-00 17x3x7



SS

**Napkin dispenser**

Portatovaglioli  
Serviettenspende  
Porte serviettes  
Servilletero

art. dim. cm.  
41601-17 8,5x11x12,5



**Napkin holder, chrome plated wire**

Portatovaglioli in filo cromato  
Serviettenhalter, Metall verchromt  
Porte-serviettes en fil chromé  
Servilletero en hilo cromado

art. dim. cm.  
41617-05 19x19x6,5



**Napkin holder, chrome plated wire**

Portatovaglioli in filo cromato  
Serviettenhalter, Metall verchromt  
Porte-serviettes en fil chromé  
Servilletero en hilo cromado

art. dim. cm.  
41617-15 19x19x19



**Napkin holder, chrome plated wire**

Portatovaglioli in filo cromato  
Serviettenhalter, Metall verchromt  
Porte-serviettes en fil chromé  
Servilletero en hilo cromado

art. dim. cm.  
41618-14 14x14x6,5



**Cash tray, 18 Cr s/s**

Vassoio conto, inox 18 Cr  
Rechnungstablett, Edelstahl 18 Cr  
Plateau porte-monnaie, inox 18 Cr  
Bandeja cuentas, acero 18 Cr

art. dim. cm.  
66318-19 19x14  
66318-22 22x15



NEW  
W

**Coffee set 4 pieces**

Servizio caffè 4 pezzi  
Kaffeaset 4 Stk  
Service à café 4 pièces  
Servicio de café 4 piezas

art. dim. cm.  
41206-03 25x18,7x2,5

Acacia wood. – Acacia.



SS

**Pastry stand, 2 tiers**

Alzata dolci, 2 piani  
Gebäckständer, 2-stufig  
Serviceur muet, 2 étages  
Soporte dulces, 2 niveles

art. Ø cm. h. cm.  
66339-02 12/16 20



PMMA

**Showcase**

Vetrina brioches  
Vitrine für Brioches  
Vitrine brioches  
Vitrina brioches

art. dim. cm.  
41472-32 37x31x31



ABS

SAN



**Showcase**

Vetrina da banco  
Vitrine für Verkaufstheke  
Vitrine à comptoir  
Vitrina

art. dim. cm.  
47091-01 44x32x20,5

**Double side opening. Equipped with s/s tray and coolers.** – Apertura doppio fronte. Con vassoio inox e eutettici.



ABS

SAN



**Showcase, 2 tiers**

Vetrina da banco, 2 piani  
Vitrine für Verkaufstheke, doppeldecker  
Vitrine à comptoir, 2 étages  
Vitrina, doble

art. dim. cm.  
47091-02 44x32x44

**Double side opening. Equipped with s/s trays and coolers.** – Apertura doppio fronte. Con vassoi inox e eutettici.



AY

PP

**Sweet box**

Contentitore universale  
Universalbox  
Boîte à comptoir  
Exibidor

art. dim. cm.  
47090-23 23x14,5x15



MF

**Cake tray**

Piatto torta  
Tortenplatte  
Plat gâteau  
Bandeja pasteles

art. Ø cm. h. cm.  
44845-31 31 4



SS

**Swivel cake stand**

Alzata torta girevole  
Tortenplatte drehbar  
Gueridon pâtissier tournante  
Pedestal giratorio para tartas

art. Ø cm. h. cm.  
47101-31 30,5 9



PS

**Dome cover**

Cloche  
Abdeckhaube  
Cloche  
Campana

art. Ø cm. h. cm.  
41414-30 30 9,5

Per art/for item: 44845-31/47101-31



MF

**Round dish**

Piatto tondo  
Platte, rund  
Plat rond  
Bandeja redonda

art. Ø cm. h. cm.  
44845-38 38 2



SAN

**Roll-top cover**

Coperchio roll-top  
Rolltophaube  
Couvercle roll-top  
Campana roll-top

art. Ø cm. h. cm.  
41447-38 38 20

Per art/for item: 44845-38, 44475-78/79



SS

**Cake stand**

Alzata torta  
Tortenplatte  
Gueridon pâtissier  
Pedestal para tartas

art. Ø cm. h. cm.  
41538-30 30 5



SS

**Cake stand**

Alzata torta  
Tortenplatte  
Gueridon pâtissier  
Pedestal para tartas

art. Ø cm. h. cm.  
47099-30 30 10



MF

**Cake stand**

Alzata torta  
Tortenplatte  
Gueridon pâtissier  
Pedestal para tartas

art. Ø cm. h. cm.  
44873-08 31 8



MF

**Cake stand**

Alzata torta  
Tortenplatte  
Gueridon pâtissier  
Pedestal para tartas

art. Ø cm. h. cm.  
44873-16 31 16



**Cake stand**  
Alzata torta  
Tortenplatte  
Gueridon pâtissier  
Pedestal para tartas

art. dim. cm.  
44874-08 31x31x8



**Cake stand**  
Alzata torta  
Tortenplatte  
Gueridon pâtissier  
Pedestal para tartas

art. dim. cm.  
44874-16 31x31x16



**Dome cover**  
Campana  
Haube  
Cloche  
Campana

art. Ø cm. h. cm.  
41414-31 30 22

Per art/for item: 44873-08/-16, 44475-79,  
41586-33, 41587-32, 44845-31, 47101-31.



**Cake platter**  
Piatto torta  
Tortenplatte  
Plat gâteau  
Bandeja pasteles

art. Ø cm. h. cm.  
44475-76 30,0 2  
44475-78 38,5 2



**Cake platter**  
Piatto torta  
Tortenplatte  
Plat gâteau  
Bandeja pasteles

art. Ø cm. h. cm.  
44475-77 30,0 2  
44475-79 38,5 2



**Cake stand**  
Alzata torta  
Tortenplatte  
Gueridon pâtissier  
Pedestal para tartas

art. Ø cm. h. cm.  
44475-80 11,5-15 10,5  
44475-82 11,5-15 20,0



**Cake stand**  
Alzata torta  
Tortenplatte  
Gueridon pâtissier  
Pedestal para tartas

art. Ø cm. h. cm.  
44475-81 21-15 10,5  
44475-83 21-15 20,0

# ICE CREAM GELATERIA

BAR HAPPY HOUR





SS

**Ice cream container**

Bacinella per gelato  
Eisbehälter  
Réceptient à glace  
Cubeta helado

art.	dim. cm.	lt.
41487-12	26x16x12	3,5
41487-15	26x16x15	4,1
41487-17	26x16x17	4,5



SS

**Ice cream container**

Bacinella per gelato  
Eisbehälter  
Réceptient à glace  
Cubeta helado

art.	dim. cm.	lt.
41471-12	36x16,5x12	5,0
41471-15	36x16,5x15	6,5
41471-17	36x16,5x17	7,5



SS

**Ice cream container**

Bacinella per gelato  
Eisbehälter  
Réceptient à glace  
Cubeta helado

art.	dim. cm.	lt.
41486-08	36x25x8	5
41486-12	36x25x12	8
41486-15	36x25x15	10



NEW

PC

**Ice cream container**

Bacinella per gelato  
Eisbehälter  
Réceptient à glace  
Cubeta helado

art.	dim. cm.	lt.
41431-12	36x16,5x12	5,4



NEW

PC

**Ice cream container**

Bacinella per gelato  
Eisbehälter  
Réceptient à glace  
Cubeta helado

art.	dim. cm.	lt.
41431-08	36x25x8	5,0



PMMA

**Lid for ice cream container**

Coperchio per bacinella gelato  
Deckel für Eisbehälter  
Couvercle pour réceptient à glace  
Tapa para cubeta helado

art.	dim. cm.
41471-00	36x16,5



NEW

PC

**Lid for ice cream container**

Coperchio per bacinella gelato  
Deckel für Eisbehälter  
Couvercle pour réceptient à glace  
Tapa para cubeta helado

art.	dim. cm.
41486-00	36x16,5
41486-01	36x25



SS

**Ice cream basin**

Carapina  
Eisbehälter  
Réceptient à glace  
Cubeta helado

art.	Ø cm.	h. cm.	lt.
41489-20	20	25	7,3



NEW

SS

**Ice cream server**

Spatola gelato carapina  
Eisspachtel  
Palette à glace  
Paleta helados

art.	col.
41475-20	○



SS

**Ice cream server**

Spatola gelato  
Eisspachtel  
Palette à glace  
Paleta helados

art.	l. cm.	col.
41475-00	27	○
41475-01	27	●
41475-03	27	●
41475-04	27	●
41475-05	27	●



**Ice-dipper**

Spatola gelato  
Eisdipper  
Cuillère à glace  
Cuchara helados

art.	Ø mm.	lt.
41468-20	55	1/20
41468-24	50	1/24

With liquid heat conductor in the handle.  
Con liquido conduttore nel manico.



**Ice-dipper**

Spatola gelato  
Eisdipper  
Cuillère à glace  
Cuchara helados

art.	Ø mm.	lt.
41469-20	55	1/20
41469-24	50	1/24

With liquid heat conductor in the handle.  
Con liquido conduttore nel manico.



SS

**Ice cream scoop**

Porzionatore  
Eisportionierer  
Cuillère à glace  
Racionador de helado

art.	Ø mm.	lt.
41476-50	50	1/24

**Non slip handle.** – Manico antiscivolo.



SS

**Ice cream scoop**

Porzionatore  
Eisportionierer  
Cuillère à glace  
Racionador de helado

art.	Ø mm.	lt.
41473-31	30	1/100
41473-39	38	1/65
41473-44	43	1/50
41473-50	50	1/24
41473-56	55	1/20
41473-62	60	1/14
41473-66	66	1/12



**Ice cream scoop**

Porzionatore  
Eisportionierer  
Cuillère à glace  
Racionador de helado

art.	Ø mm.	lt.
41488-45	45	1/40
41488-47	47	1/36
41488-50	50	1/30
41488-53	53	1/24

**Nylon, fiberglass. Stainless steel mechanism.**  
Meccanismo in acciaio inox.



SS

**Oval ice cream scoop**

Porzionatore ovale  
Eisportionierer, oval  
Cuillère à glace ovale  
Racionador de helado oval

art.	Ø mm.	lt.
41474-00	60	1/30



SS

**Triangle ice cream scoop**

Porzionatore triangolare  
Eisportionierer, dreieckig  
Cuillère à glace triangle  
Racionador de helado triangular

art.	lt.
41474-02	1/30



NEW

**Decorative scrapers 5 pcs**

Raschietti decorativi 5 pezzi  
Dekorative Schaber 5 Stk  
Raclettes décoratives 5 Pièces  
Rasquetas decorativas 5 pz

art.	dim. cm.
41472-43	14,5x15

**PETG.**



**Chalkmarker**

Penna a gesso liquido  
Kreidestifte  
Stylo à craie liquide  
Marcadores de tiza líquida

art.	col.
47832-01	●
47832-03	●
47832-04	●
47832-05	●

**Writes on all non porous surfaces. Clean with water.** – Scrive su tutte le superfici non porose. Pulire con acqua.



NEW

PMMA

**Flavour marker holder 10 pcs**

Porta segnagusto 10 pezzi  
Eisschilderhalter 10 Stk  
Porte-étiquettes 10 pièces  
Porta etiquetas 10 pz

art.	mm.
41472-46	87x52

**Labels not included.** – Cartellino non incluso.



NEW

PMMA

**Flavour marker 10 pcs**

Segnagusto 10 pezzi  
Eisschilder 10 Stk  
Étiquettes 10 pièces  
Etiquetas sabores 10 pz

art.	mm.
41472-44	190x85



NEW

PMMA

**Flavour marker 10 pcs**

Segnagusto 10 pezzi  
Eisschilder 10 Stk  
Etiquettes 10 pièces  
Etiquetas sabores 10 pz

art. mm.  
41472-45 150x70



SS

**Counter ice cream cone holder**

Porta conì da banco  
Theke-Eiswaffelständer  
Porte cornets à glace de comptoir  
Expositor para cucuruchos

art. Ø cm. h. cm.  
41472-04 16,5 14



NEW

PMMA

**Counter ice cream cone holder**

Porta conì da banco  
Theke-Eiswaffelständer  
Porte cornets à glace de comptoir  
Expositor para cucuruchos

art.	Ø mm.	dim. cm.
41472-07	3,5	21x8,5x11
41472-08	3,5	28,5x8,5x11



SS

**Counter ice cream cone holder**

Porta conì da banco  
Theke-Eiswaffelständer  
Porte cornets à glace de comptoir  
Expositor para cucuruchos

art. dim. cm.  
41472-01 20x9,5x8,5



NEW

PMMA

**Paper napkins holder**

Porta tovaglioli  
Serviettenhalter  
Porte serviettes  
Porta servilletas

art. dim. cm.  
41472-12 18x6x10



NEW

PMMA

**Paper napkins holder**

Porta tovaglioli  
Serviettenhalter  
Porte serviettes  
Porta servilletas

art. dim. cm.  
41472-13 18x6x11



AY

PP

**Universal box**

Contenitore universale  
Universalbox  
Conteneur à comptoir  
Contenedor universal

art. dim. cm.  
47090-23 23x14,5x15



**NEW**  
PMMA

**Box with lid**

Contenitore con coperchio  
Behälter mit Deckel  
Boîte avec couvercle  
Recipiente con tapa

art. dim. cm.  
41472-25 27,5x10,5x9,5

**Compartments 8,5x8 cm. – Scomparti 8,5x8 cm.**



**NEW**  
PMMA

**Box with lid**

Contenitore con coperchio  
Behälter mit Deckel  
Boîte avec couvercle  
Recipiente con tapa

art.	Ø mm.	h. cm.
41472-26	10	15
41472-27	12	15
41472-28	15	15
41472-29	18	15



PMMA

**Waffle case**

Contenitore per cialde  
Waffelbehälter  
Porte gaufres  
Dispensador waffles

art. dim. cm.  
41472-21 22x26x12



PMMA

**Spoon case**

Contenitore per palette  
Eislöffelbehälter  
Porte cuillères à glace  
Dispensador cucharillas de helado

art. dim. cm.  
41472-20 19x12,5x14



PMMA

**Straws case**

Contenitore per cannuce  
Strohalmbehälter  
Porte chalumeaux  
Dispensador pajitas

art. dim. cm.  
41472-22 26x17x22



PMMA

**Cone holder, front opening**

Porta coni, apertura frontale  
Eiswaffelspender mit Frontöffnung  
Porte cornets à glace, ouverture frontale  
Porta cucuruchos, abertura frontal

art. dim. cm.  
41472-16 11x13x50



**NEW**  
PMMA

**Spoon and cup holder**

Porta palette e coppette  
Eislöffel und Schalenbehälter  
Porte cuillères et pots  
Dispensador cucharillas y copas

art. dim. cm.  
41472-17 28x25x55



**NEW**  
PMMA

**Cone holder 6 holes with spoon drawer**

Porta coni 6 fori c/porta palette  
Eiswaffelspender, 6 Löcher mit Palettenhalter  
Porte cornets 6 trous, porte cuillères  
Porta cucuruchos/cucharillas, 6 orificios

art. dim. cm.  
41472-18 25,5x18x60,5

**Upper hole Ø 3,5 cm. Lower Ø 2 cm. Distance between holes Ø 4,5 cm. Removable lower drawer. – Foro superiore Ø 3,5 cm. Inferiore Ø 2 cm. Distanza tra i fori Ø 4,5 cm. Cassetto inferiore estraibile.**



**NEW**  
PMMA

**Cone holder 12 holes**

Porta coni 12 fori  
Eiswaffelspender, 12 Löcher  
Porte cornets 12 trous  
Porta cucuruchos 12 orificios

art. dim. cm.  
41472-24 33x25x50

**Upper hole Ø 5,2 cm. Lower Ø 2 cm. Foro superiore Ø 5,2 cm. Inferiore Ø 2 cm.**





**NEW**

**PMMA**

**Swivel cone holder 5 sections**

Porta coni rotante 5 sezioni  
Eiswaffelspender, drehbar, 5 Fächer  
Porte cornets rotatif, 5 comp  
Porta cucurucho giratorio 5 secciones

art.            Ø cm.    h. cm.

41472-23    25      50

**Upper hole Ø 3,5 cm. Lower Ø 2 cm. Distance between holes Ø 4,5 cm. – Foro superiore Ø 3,5 cm. Inferiore Ø 2 cm. Distanza tra i fori Ø 4,5 cm.**



**NEW**

**PMMA**

**Cone holder with door**

Porta coni con porta  
Eiswaffelspender mit Tür  
Porte cornets ouverture frontale  
Porta cucurucho, abertura frontal

art.            dim. cm.

41472-19    33x18x50



**NEW**

**PMMA**

**Horizontal cone holder with door**

Porta coni orizzontale con porta  
Eiswaffelspender horizontal mit Tür  
Porte cornets à glace horizontal  
Porta cucurucho horizontal

art.            Ø cm.    dim. cm.

41472-14    30    42x37x40,5

**With removable divider. – Con divisorio estraibile.**



**PMMA**

**Revolving cones dispenser**

Porta coni girevole  
Eiswaffelspender, drehbar  
Porte-cornets pivotant  
Distributor giratorio de cucurucho

art.            Ø cm.    h. cm.

41472-15    24      78



**MS**

**Ice cream cup**

Coppa gelato  
Eisbecher  
Coupe à glace  
Copa helado

art.            h. cm.    lt.    U. Pack

44942-12    6,5    0,26    6



**MS**

**Ice cream cup**

Coppa gelato  
Eisbecher  
Coupe à glace  
Copa helado

art.            h. cm.    lt.    U. Pack

44942-11    11    0,38    6



**MS**

**Ice cream cup**

Coppa gelato  
Eisbecher  
Coupe à glace  
Copa helado

art.            h. cm.    lt.    U. Pack

44942-10    16    0,25    6



**MS**

**Ice cream cup**

Coppa gelato  
Eisbecher  
Coupe à glace  
Copa helado

art.            Ø cm.    h. cm.    U. Pack

44942-06    10    10    6



**MS**

**Ice cream cup**

Coppa gelato  
Eisbecher  
Coupe à glace  
Copa helado

art.            Ø cm.    h. cm.    U. Pack

44942-07    9    19    6

**BAR HAPPY HOUR**



MF

**Gourmet bowl**  
Ciotolina Gourmet  
Schälchen Gourmet  
Bol Gourmet  
Bol Gourmet

art.	Ø cm.	h. cm.	ml.
44466-07	7	6	50



MF

**Gourmet tray**  
Vassoio Gourmet  
Tablett Gourmet  
Plateau Gourmet  
Bandeja Gourmet

art.	dim. cm.
44466-30	30,5x9,5x2,5

**COMPOSTABLE - COMPOSTABILI**



An eco-friendly version of disposable items. Suitable both for pastry shops and events. Made of PLA INGEOTM, a revolutionary compostable and patented biopolymer that originates from plants and produced in a natural way.

Versione ecologica che rispetta l'ambiente. Realizzati in PLA INGEOTM, un rivoluzionario biopolimero compostabile e brevettato, derivato da piante e prodotto in modo naturale. Adatti sia nelle pasticcerie che per eventi.



**Glass**  
Bicchierino  
Glas  
Verrine  
Vaso

art.	Ø cm.	h. cm.	ml.
48373-06	4,2	6,5	65
48373-09	5,0	6,5	90
48373-12	5,5	7,0	120
48373-17	6,0	9,0	170

**Pcs/Conf. 100 pz.**



**NATURAL ELEGANT**



A valid alternative to glass. Elegant and unbreakable ideals for HORECA pastry and ice cream sector. Made with high quality material that confers beside resistance also glossiness and perfect transparency. Bisphenol free. Thermal tolerance -18°C +70°C. 100% recyclable material. Dishwasher safe: up to 50 washes. Made in Italy.

La valida alternativa al vetro. Eleganti ed infrangibili ideali per il settore HORECA della pasticceria e gelateria. Realizzati con materiale di alta qualità che gli conferisce oltre alla resistenza anche lucidità e trasparenza. Privi di Bisfenolo. Tolleranza termica -18°C +70°C. Materiale riciclabile al 100%. Lavabili in lavastoviglie: fino a 50 lavaggi. Prodotti made in Italy.



NEW

**Bowl**  
Coppetta  
Schale  
Coupe  
Copa

art.	Ø cm.	h. cm.	ml.
48367-10	7	5,9	105

**Pcs/Conf. 100 pz.**



NEW

**Glass**  
Bicchierino  
Glas  
Verrine  
Vaso

art.	dim. cm.	des.	ml.
48371-10	7,3x6,4x5,2	-	100
48371-11		lid/coperchio	

**Pcs/Conf. 100 pz.**



PS

Cup  
Coppetta  
Schale  
Coupelle  
Bol

art.	Ø cm.	h. cm.	ml.
48365-09	9	7,5	175

Pcs/Conf. 100 pz.



NEW

Glass  
Bicchierino  
Glas  
Verrine  
Vaso

art.	Ø cm.	h. cm.	ml.
48370-10	7,8	5,7	210
48370-11	lid/coperchio		

Pcs/Conf. 100 pz.



PS

Cup  
Coppetta  
Schale  
Coupelle  
Bol

art.	Ø cm.	h. cm.	ml.
48366-09	9	7,5	125

Pcs/Conf. 100 pz.



PS

Glass  
Bicchierino  
Glas  
Verrine  
Vaso

art.	Ø cm.	h. cm.	ml.
48354-01	4	8,5	70

Pcs/Conf. 100 pz.



PS

Glass  
Bicchierino  
Glas  
Verrine  
Vaso

art.	Ø cm.	h. cm.	ml.
48350-01	4,2	6,5	50
48350-02	5,0	6,5	80
48350-03	5,5	7,0	100
48350-04	6,0	9,0	160

Pcs/Conf. 100 pz.



PS

Glass  
Bicchierino  
Glas  
Verrine  
Vaso

art.	Ø cm.	h. cm.	ml.
48353-01	8,5	6,5	120

Pcs/Conf. 100 pz.



**PS**

**Glass**  
Bicchierino  
Glas  
Verrine  
Vaso

art.	dim. cm.	ml.
48351-01	4x4x5,5	50
48351-02	5x5x7	100
48351-03	5,5x5,5x8	150

**Pcs/Conf. 100 pz.**



**PS**

**Glass**  
Bicchierino  
Glas  
Verrine  
Vaso

art.	Ø cm.	h. cm.	ml.
48352-01	6,5	5,5	70
48352-02	7,0	6,7	120
48352-03	7,5	7,3	150

**Pcs/Conf. 100 pz.**



**NEW**

**Ice tube mold**  
Stampo gelato  
Eisform  
Moule à glace  
Molde helado

art.	ml.
41472-36	150

**Pcs/Conf. 100 pz.**



**NEW**

**PMMA**

**Ice cream counter display**  
Espositore per vetrina gelato  
Ständer für Eiscremetheke  
Présentoir de comptoir  
Expositor helados

art.	dim. cm.	holes/fori
41472-34	25x36x4,5	21
41472-35	16x36x4,5	15

**For mold/Per stampo: 41472-36.**



**NEW**

**PMMA**

**Holder for blast chiller**  
Supporto per abbattitore  
Ständer für Schnellabkühler  
Présentoir à cellule de refroidissement  
Soporte para abatidor

art.	dim. cm.	holes/fori
41472-33	29x39x12	28

**For mold/Per stampo: 41472-36.**



**NEW**

**Mini push up pops**

Stampi mini push up pops  
Mini push up pops Eisformen  
Moules à mini push up pops  
Mini push up pops moldes

art.	Ø cm.	h. cm.	ml.
41472-37	4,0	18,8	90
41472-38	3,5	19,6	50

**Pcs/Conf. 100 pz.**



**NEW**

**PMMA**

**Ice cream counter display**

Espositore per vetrina gelato  
Ständer für Eiscremetheke  
Présentoir de comptoir  
Expositor helados

art.	dim. cm.	holes/fori
41472-39	25x36x4	21
41472-40	16x36x4	15

**For molds/Per stampi: 41472-37 - 41472-38.**



**NEW**

**PMMA**

**Display for mini ice cream cones**

Espositore per mini cornetti  
Waffelhörnchen-Ständer  
Présentoir à mini cornet à glace  
Expositor mini conos helado

art.	Ø cm.	dim. cm.	holes/fori
41472-41	1,8	36x16,5	27
41472-42	1,8	36x25	45

**Suitable for all waffle minicones on the market.**  
Per tutti i miniconi in cialda in commercio.



**NEW**

**Ice cream mold, silicone**

Stampo gelato su stecco, silicone  
Eisform, Silikon  
Moule à glace, silicone  
Molde helado, silicona

art.	mm.	ml.	pcs/pz
41472-47	44x22x93	78	12

**Kit 2 molds of 6 pcs with white plastic tray and 50 pcs wooden sticks.** – Kit 2 stampi da 6 pz con vassoio in plastica e 50 bastoncini legno.



**NEW**

**PMMA**

**Ice cream counter display**

Espositore per vetrina gelato  
Ständer für Eiscremetheke  
Présentoir de comptoir  
Expositor helados

art.	dim. cm.	pcs/pz
41472-48	36x25x5	24

**For mold/Per stampo: 41472-47.**



**NEW**

**Tray with cover**

Vassoio con coperchio  
Tablett mit Deckel  
Plateau avec couvercle  
Bandeja con tapa Cm 59X39X8

art.	dim. cm.
41472-50	59x39x8

**Unbreakable, shock resistant even at very low temperatures.** – Infrangibile, resistente agli urti anche a bassissime temperature.



**NEW**

**ABS**

**Tempering unit**

Temperatrice  
Temperiergerät  
Tempereuse  
Templadora

art.	Ø cm.	h. cm.	lt.
47698-01	20,5	21,2	1,7

**Ideal for chocolate coatings of ice creams on sticks. Removable anodized aluminum tank.** Ideale per coperture in cioccolato di gelati e semifreddi su stecco. Vasca estraibile in alluminio anodizzato.



NEW  
ABS

**Tempering unit**

Temperatrice  
Temperiergerät  
Tempereuse  
Templadora

art.	Ø cm.	h. cm.	lt.
47698-02	26	16	1,8

**Allows to process tiny chocolate quantities without any waste. Removable tank.**

Adatto per piccole produzioni senza sprechi. Pratica vasca estraibile.



KAYSER SS

**Professional cream whipper**

Sifone panna professionale  
Profi-Sahnebereiter  
Siphon à crème professionnel  
Sifón montador de nata profesional

art.	lt.
41451-05	0,5
41451-10	1,0



**Cream chargers, 10-pcs set**

Ricariche panna montata, conf. 10 pezzi  
10-Stk. Sahnekapseln-Packung  
Capsules à crème Chantilly, set 10 pièces  
Cápsulas para nata, 10 piezas

art.
41450-AA

**Contains N2O under pressure.**  
Contiene N2O sotto pressione.



SS

**GOURMET-Cream whipper**

Sifone panna  
Sahnebereiter  
Siphon à crème  
Sifón para nata montada

art.	lt.
41458-02	0,25
41458-05	0,50
41458-10	1,00

**Heat resistant silicone gasket. Keep warm in bain marie up to 75°C.** – Guarnizione in silicone resistente al calore. Tenere a bagnomaria max. a 75°C.



SS

**THERMO-Cream whipper**

Sifone termico  
Thermo-Sahnebereiter  
Siphon à crème, isotherme  
Sifón isotérmico

art.	lt.
41455T55	0,5

**Double-walled, insulated bottle: keeps creations cold for 8 hours and hot for 3 hours, dishwasher-safe.** – Bottiglia termica, mantiene le preparazioni in caldo fino a 3 ore e a freddo fino a 8 ore.



SS

**THERMO SPRESS-Cream whipper**

Sifone termico  
Thermo-Sahnebereiter  
Siphon à crème, isotherme  
Sifón isotérmico

art.	h. cm.	lt.
41459-10	35	1

**Double-walled, insulated bottle, keeps creations cold for 8 hours and hot for 3 hours.** – Bottiglia termica, mantiene le preparazioni in caldo fino a 3 ore e a freddo fino a 8 ore, lavabile in lavastoviglie.



SS

**PROFI-Cream whipper**

Sifone panna  
Sahnebereiter  
Siphon à crème  
Sifón para nata montada

art.	lt.
41460-05	0,5
41460-10	1,0

**Only for cold preparations.**  
Solo per preparazioni fredde.



**Decorating tips, 3-pcs set**

Bocchette, set 3 pezzi  
Dekorationstüllen, 3er Set  
Douilles de décoration, 3 pièces  
Boquillas de decoración, 3 piezas

art.
41455-BC



SS

**Decorating tips, 3-pcs set**

Bocchette, set 3 pezzi  
Dekorationstüllen, 3er Set  
Douilles de décoration, 3 pièces  
Boquillas de decoración, 3 piezas

art.
41458-23



**Decorating tips and adapter**

Bocchette decoro e adattatore  
Dekorationstüllen-Set u. Adapter  
Douilles de décoration et adaptateur  
Boquillas de decoración y adaptador

art. 41458-24



**Injector needles**

Iniettori/siringhe decoro  
Nadeltüllen  
Aiguilles d'injection  
Boquillas de aguja

art. 41458-21



**Heat protector, silicone**

Protezione in silicone  
Silikonhülle  
Housse en silicone  
Protección de silicona

art.	lt.
41458-50	0,5
41458-51	1,0



**Cream chargers, PROFESSIONAL**

Ricariche panna montata, PROFESSIONAL  
Sahnepapseln-Packung, PROFESSIONAL  
Capsules à crème Chantilly, PROFESSIONAL  
Cápsulas para nata, PROFESSIONAL

art.	pcs/pz
41455-CA	24
41455-CB	50

**Filled with 8,4 g of N2O (E942, nitrous oxide).**  
Contenuto: 8,4 g di N2O (E942 protossido di azoto).



**Funnel and sieve**

Imbuto e colino  
Trichter und Sieb  
Entonnoir et tamis  
Embudo y tamiz

art. 41458-11



**Kit rapid infusion**

Kit di infusione rapida  
Rapid Infusion Set  
Paquet rapid infusion  
Rapid infusion set

art. 41458-25

**Enables a liquid to be infused with different flavors in the shortest possible time. First, combine aromatic solids (e.g. herbs, spices, fruit) and a liquid (e.g. alcohol, oil, water, vinegar) in the whipper then apply pressure into it using a cream charger.** – Permette di infondere un liquido con sapori diversi in tempo rapido. Unire gli aromi solidi (erbe, spezie, frutta, ecc.) con il liquido (alcol, olio, acqua, aceto, ecc.) nel sifone ed immettere una carica per panna.



# COCKTAIL BAR

BAR HAPPY HOUR



SPECIAL THANKS TO : Ristorante I GEMELLI Via San Marco, 26, 20121 Milano, Italia

Paderno offers a wide selection of bar equipment, designed to combine easy use with efficiency and style. The tools are flanked by fascinating accessories making every moment trendy and lively. To share refined happy hours, to enjoy spectacular cocktails and long drinks, or to add style to every sort of drink.

Paderno propone un'ampia selezione di attrezzature bar, ideata per unire praticità d'utilizzo a efficienza e stile. Agli utensili si affiancano affascinanti accessori in grado di rendere trendy e vivace ogni momento. Per condividere raffinati happy hour, per gustare scenografici cocktail e long drink, oppure per aggiungere stile a ogni tipo di bevanda.





SS

**Pumpkin mug**

Coppa zucca  
Kürbis-Becher  
Gobelet citrouille  
Vaso de calabaza

art.	Ø cm.	h. cm.	ml.	col.
44944G07	10	14,5	700	●
44944C07	10	14,5	700	●



SS

**Pineapple cup with straw**

Coppa ananas con cannuccia  
Ananas-Becher mit Strohhalme  
Gobelet ananas avec paille  
Vaso de piña con pajita

art.	Ø cm.	h. cm.	ml.	col.
44945G05	9,5	20,5	500	●
44945C05	9,5	20,5	500	●



SS

**Champagne glass**

Flute champagne  
Champagner Glas  
Verre champagne  
Copa champán

art.	Ø cm.	h. cm.	ml.	col.
41493G00	5	25,5	270	●
41493C00	5	25,5	270	●
41493B00	5	25,5	270	●



SS

**Martini cup**

Coppa martini  
Martini Cocktail Glas  
Verre à martini  
Copa martini

art.	Ø cm.	h. cm.	ml.	col.
41494G00	12	16,5	200	●
41494C00	12	16,5	200	●
41494B00	12	16,5	200	●



SS

**Margarita cup**

Coppa margarita  
Margarita Cocktail Glas  
Verre à margarita  
Copa margarita

art.	Ø cm.	h. cm.	ml.	col.
41498G00	10,5	14	220	●
41498C00	10,5	14	220	●
41498B00	10,5	14	220	●



SS

**Moscow mule mug**

Tazza moscow mule  
Moscow Mule Becher  
Gobelet moscow mule  
Taza moscow mule

art.	Ø cm.	h. cm.	ml.	col.
41463-01	8,9	9	500	●





SS

**Moscow mule mug**  
Tazza moscow mule  
Moscow Mule Becher  
Gobelet moscow mule  
Taza moscow mule

art.	Ø cm.	h. cm.	ml.	col.
41463-02	8,5	9,7	500	●

**Gold plated handle.** – Manico dorato.



SS

**Moscow mule mug, antique**  
Tazza moscow mule, antique  
Moscow Mule Becher, Antik  
Gobelet moscow mule, antique  
Taza moscow mule, antiguo

art.	Ø cm.	h. cm.	ml.	col.
41463A05	8,5	9,7	500	●

**Gold plated handle.** – Manico dorato.



SS

**Moscow mule mug**  
Tazza moscow mule  
Moscow Mule Becher  
Gobelet moscow mule  
Taza moscow mule

art.	Ø cm.	h. cm.	ml.	col.
41463G05	8,5	9,7	500	●

**Gold plated handle.** – Manico dorato.



SS

**Moscow mule mug**  
Tazza moscow mule  
Moscow Mule Becher  
Gobelet moscow mule  
Taza moscow mule

art.	Ø cm.	h. cm.	ml.	col.
41463B05	8,5	9,7	500	●

**Gold plated handle.** – Manico dorato.



NEW

SS

**Moscow mule mug**  
Tazza moscow mule  
Moscow Mule Becher  
Gobelet moscow mule  
Taza moscow mule

art.	Ø cm.	h. cm.	ml.
41463M05	8,5	10	550

**Water transfer printing. Gold plated handle.**  
Stampa a trasferimento ad acqua. Manico dorato.



SS

**Moscow mule mug**  
Tazza moscow mule  
Becher Moscow Mule  
Gobelet moscow mule  
Taza moscow mule

art.	Ø cm.	h. cm.	lt.	col.
41463C30	15,5	17,5	3	●
41463C50	18,0	20,0	5	●

**Gold plated handle.** – Manico dorato.



SS

**Moscow mule mug, antique**  
Tazza moscow mule, antique  
Becher Moscow Mule, Antik  
Gobelet moscow mule, antique  
Taza moscow mule, antiguo

art.	Ø cm.	h. cm.	lt.	col.
41463A30	15,5	17,5	3	●
41463A50	18,0	20,0	5	●

**Gold plated handle.** – Manico dorato.



SS

**Mini moscow mule mug**

Mini moscow mule  
Moscow Mule Shotbecher  
Moscow mule à shot  
Chupito moscow mule

art.	Ø cm.	h. cm.	ml.	col.
41463C00	4,6	4,7	60	●

Gold plated handle. Set 4 pcs. – Manico dorato. Conf. 4 pz.



SS

**Mini moscow mule mug, antique**

Mini moscow mule, antique  
Moscow Mule Shotbecher, Antik  
Moscow mule à shot, antique  
Chupito moscow mule, antiguo

art.	Ø cm.	h. cm.	ml.	col.
41463A00	4,6	4,7	60	●

Gold plated handle. Set 4 pcs. – Manico dorato. Conf. 4 pz.



NEW

SS

**Cola cup**

Tazza Cola  
Cola-Becher  
Gobelet Cola  
Taza Cola

art.	Ø cm.	h. cm.	ml.	col.
44941G05	7,5	11	490	●
44941C05	7,5	11	490	●
44941B05	7,5	11	490	●



SS

**Mint julep cup**

Coppa mint julep  
Becher für Mint Julep  
Tasse à cocktail mint julep  
Vaso para mint julep

art.	Ø cm.	h. cm.	ml.	col.
41497-05	8,5	10,5	380	●
41497G05	8,5	10,5	380	●
41497C05	8,5	10,5	380	●
41497B05	8,5	10,5	380	●



SS

**Julep mug**  
Tazza julep  
Becher Julep  
Gobelet julep  
Taza julep

art.	Ø cm.	h. cm.	ml.	col.
41470C03	8	12	335	●



SS

**Julep mug, antique**  
Tazza julep, antique  
Becher Julep, Antik  
Gobelet julep, antique  
Taza julep, antiguo

art.	Ø cm.	h. cm.	ml.	col.
41470A03	8	12	335	●



SS

**Mini mug**  
Mini tazza  
Shotbecher  
Verre à shot  
Vaso de chupito

art.	Ø cm.	h. cm.	ml.	col.
41470C00	4,5	5,5	60	●

Set 4 pcs. – Conf. 4 pz.



SS

**Mini mug, antique**  
Mini tazza, antique  
Shotbecher, Antik  
Verre à shot, antique  
Vaso de chupito, antiguo

art.	Ø cm.	h. cm.	ml.	col.
41470A00	4,5	5,5	60	●

Set 4 pcs. – Conf. 4 pz.



NEW

**Tiki skull glass**  
Tiki mug teschio in vetro  
Tiki-Schädelglas  
Tiki mug crâne en verre  
Vaso Tiki de vidrio

art.	Ø cm.	h. cm.	ml.
44948-07	13	10,5	700





NEW

**Tiki mug ceramic**

Tiki mug in ceramica  
Tiki-Becher aus Keramik  
Tiki mug en céramique  
Taza Tiki en cerámica

art.	Ø cm.	h. cm.	ml.
44949-01	9,3	11	450



NEW

**Tiki mug ceramic**

Tiki mug in ceramica  
Tiki-Becher aus Keramik  
Tiki mug en céramique  
Taza Tiki en cerámica

art.	h. cm.	ml.
44949-02	22	500



NEW

**Tiki mug ceramic**

Tiki mug in ceramica  
Tiki-Becher aus Keramik  
Tiki mug en céramique  
Taza Tiki en cerámica

art.	Ø cm.	h. cm.	ml.
44949-03	7	21,5	650



NEW

**Tiki mug ceramic**

Tiki mug in ceramica  
Tiki-Becher aus Keramik  
Tiki mug en céramique  
Taza Tiki en cerámica

art.	h. cm.	ml.
44949-04	15	550



NEW

**Tiki mug ceramic**

Tiki mug in ceramica  
Tiki-Becher aus Keramik  
Tiki mug en céramique  
Taza Tiki en cerámica

art.	Ø cm.	h. cm.	ml.
44949-05	8	16,5	340



NEW

**Tiki mug ceramic**

Tiki mug in ceramica  
Tiki-Becher aus Keramik  
Tiki mug en céramique  
Taza Tiki en cerámica

art.	Ø cm.	h. cm.	ml.
44949-06	8	17	510



PVD

SS

**Straight straws**

Cannucce  
Strohhalme  
Pailles  
Pajitas

art.	Ø mm.	l. cm.	col.
41490-00	6	21,5	●
41490B00	6	21,5	●
41490G00	6	21,5	●
41490C00	6	21,5	●

Set 12 pcs plus 1 straw brush.  
Conf. 12 pz + 1 scovolino.

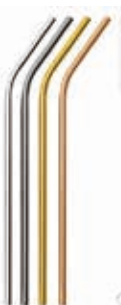

PVD

SS

**Curved straws**

Cannucce curve  
Gebogene Strohhalme  
Pailles incurvées  
Pajitas curvados

art.	Ø mm.	l. cm.	col.
41490-01	6	21,5	●
41490B01	6	21,5	●
41490G01	6	21,5	●
41490C01	6	21,5	●

Set 12 pcs plus 1 straw brush.  
Conf. 12 pz + 1 scovolino.



SS

**Straw brush, 5 pcs**

Scovolini, 5 pezzi  
Strohhalme-Bürste, 5 Stk.  
Brosses à pailles, 5 pièces  
Cepillos para pajitas, 5 pz

art.	l. cm.
41490-AA	21



**B**

**Straight straws, 24 pcs**

Cannucce, 24 pz  
Strohhalme, 24 Stk  
Pailles, 24 pièces  
Pajitas, 24 piezas

art.	Ø mm.	l.
48310-14	5-7	140
48310-20	5-7	200



**B**

**Straight straws, 150 pcs**

Cannucce, 150 pz  
Strohhalme, 150 Stk  
Pailles, 150 pièces  
Pajitas, 150 piezas

art.	Ø mm.	l.
48311-20	6-8	200
48311-25	6-8	250



**B**

**Straight straws, 110 pcs**

Cannucce, 110 pz  
Strohhalme, 110 Stk  
Pailles, 110 pièces  
Pajitas, 110 piezas

art.	Ø mm.	l.
48312-25	9-10	250



**B**

**Straight straws, 24 pcs**

Cannucce, 24 pz  
Strohhalme, 24 Stk  
Pailles, 24 pièces  
Pajitas, 24 piezas

art.	Ø mm.	l.
48313-14	10-12	140
48313-18	10-12	180
48313-20	10-12	200



**3 Straight straws, 3 bent, glass**

3 Cannucce diritte, 3 curve in vetro  
3 Gerade Strohhalme, 3 gebogene aus Glas  
3 Pailles droites, 3 incurvés en verre  
3 Pajitas eectas, 3 curvados de vidrio

art.	Ø mm.	l.
41495-08	8	215
41495-10	10	215

**Incl. 2 straw brushes. – Incl. 2 scovolini.**



**SS**

**Drinks stirrers flamingo, 4 pcs**

Miscelatori cocktail fenicottero, 4 pz  
Flamingo-Cocktail Rührer, 4 Stk  
Agitateurs cocktails flamant, 4 pcs  
Agitadores cócteles flamingo, 4 pz

art.	l. cm.	col.
41491G00	21,5	●
41491C00	21,5	●



**SS**

**Drinks stirrers skull, 4 pcs**

Miscelatori cocktail teschio, 4 pz  
Totenkopf-Cocktail Rührer, 4 Stk  
Agitateurs tête de mort, 4 pcs  
Agitadores cócteles cráneo, 4 pz

art.	l. cm.	col.
41491G01	18,5	●
41491C01	18,5	●



**SS**

**Drinks stirrers pineapple, 4 pcs**

Miscelatori cocktail ananas, 4 pz  
Ananas-Cocktail Rührer, 4 Stk  
Agitateurs cocktails ananas, 4 pcs  
Agitadores cócteles piña, 4 pz

art.	l. cm.	col.
41491G02	20	●
41491C02	20	●



SS

**Drinks stirrers owl, 4 pcs**

Miscelatori cocktail gufo, 4 pz  
Eule-Cocktail Rührer, 4 Stk  
Agitateurs cocktails hibou, 4 pcs  
Agitadores cócteles búho, 4 pz

art.	l. cm.	col.
41491G03	20	●
41491C03	20	●



SS

**Drinks stirrers seahorse, 4 pcs**

Miscelatori cavalluccio marino, 4 pz  
Seepferdchen-Cocktail Rührer, 4 Stk  
Agitateurs hippocampe, 4 pcs  
Agitadores caballo de mar, 4 pz

art.	l. cm.	col.
41491G04	20,5	●
41491C04	20,5	●



SS

**Drinks stirrers bow-knot, 4 pcs**

Miscelatori cocktail fiocco, 4 pz  
Bogenknoten-Cocktail Rührer, 4 Stk  
Agitateurs noeud d'arc, 4 pcs  
Agitadores nudo de proa, 4 pz

art.	l. cm.	col.
41491G05	21	●
41491C05	21	●



SS

**Drinks stirrers octopus, 4 pcs**

Miscelatori cocktail polipo, 4 pz  
Tintenfisch-Cocktail Rührer, 4 Stk  
Agitateurs cocktails poulpe, 4 pcs  
Agitadores cócteles pulpo, 4 pz

art.	l. cm.	col.
41491G06	18,5	●
41491C06	18,5	●



SS

**Tweezer**

Pinza  
Zange  
Pince  
Pinza

art.	l. cm.	col.
42902-30	30	●
42902G30	30	●



SS

**Tweezer**

Pinza  
Zange  
Pince  
Pinza

art.	l. cm.	col.
42902C30	30	●
42902B30	30	●



SS

**Tweezer**

Pinza  
Zange  
Pince  
Pinza

art.	l. cm.
42902-31	30



SS

**Cocktail spoon**

Cucchiaio miscelatore  
Cocktail-Löffel  
Cuillère à cocktail  
Cuchara cóctel

art.	l. cm.
41605-00	27



SS

**Cocktail spoon**

Cucchiaio miscelatore  
Cocktail-Löffel  
Cuillère à cocktail  
Cuchara cóctel

art.	l. cm.	col.
41605-01	28	●



SS

**Cocktail spoon**

Cucchiaio miscelatore  
Cocktail-Löffel  
Cuillère à cocktail  
Cuchara cóctel

art.	l. cm.	col.
41605G27	28	●
41605B27	28	●



SS

**Cocktail spoon/fork**

Cucchiaio/forchetta miscelatore  
Cocktail-Löffell/-Gabel  
Cuillère/fourchette à cocktail  
Cuchara/tenedor cóctel

art.	l. cm.	col.
41605-03	50	●
41605G03	50	●



SS

**Cocktail spoon/fork**

Cucchiaio/forchetta miscelatore  
Cocktail-Löffell/-Gabel  
Cuillère/fourchette à cocktail  
Cuchara/tenedor cóctel

art.	l. cm.	col.
41605C03	50	●
41605B03	50	●





SS

**Ice tea spoon**

Cucchiaio bibita  
Limonadenlöffel  
Cuillère à soda  
Cuchara refresco

art.	l. cm.	U. Pack
41605-25	25	6



SS

**Absinthe spoon**

Cucchiaio assenzio  
Absinth-Löffel  
Cuillère d'absinthe  
Cuchara de ajenjo

art.	l. cm.	col.
41600-00	16	●
41600G00	16	●
41600C00	16	●



SS

**Magic spoon whisks**

Cucchiaio magico  
Zauberlöffel  
Fouet plat à spirales  
Cuchara mágica

art.	l. cm.
41595-20	20



SS

**Strainer**

Colino  
Sieb  
Passoire  
Colador

art.	Ø cm.	col.
41570-10	10	●
41570G10	10	●



SS

**Strainer**

Colino  
Sieb  
Passoire  
Colador

art.	Ø cm.	col.
41570C10	10	●
41570B10	10	●



SS

**Cocktail strainer**

Colino cocktail  
Cocktail-Sieb  
Passoire à cocktail  
Colador cóctel

art.	Ø cm.	col.
41603-00	9	●
41603G00	9	●



SS

**Cocktail strainer**

Colino cocktail  
Cocktail-Sieb  
Passoire à cocktail  
Colador cóctel

art.	Ø cm.	col.
41603C00	9	●
41603B00	9	●



SS

**Julep strainer**

Colino Julep  
Julep Barsieb  
Tamis cocktail Julep  
Colador de cóctel

art.	Ø cm.	col.
41603-07	7,5	●
41603G07	7,5	●



SS

**Julep strainer**

Colino Julep  
Julep Barsieb  
Tamis cocktail Julep  
Colador de cóctel

art.	Ø cm.	col.
41603C07	7,5	●
41603B07	7,5	●





SS

**Cocktail measuring cup**

Misurino cocktail  
Alkohol-Meßbecher  
Mesureur de cocktail  
Medidor de cóctel

art.	ml.
41609-75	75



SS

**Cocktail measuring cup**

Misurino cocktail  
Alkohol-Meßbecher  
Mesureur de cocktail  
Medidor de cóctel

art.	ml.	col.
41609-36	30/60	●
41609G36	30/60	●
41609C36	30/60	●
41609B36	30/60	●



SS

**Cocktail measuring cup**

Misurino cocktail  
Alkohol-Meßbecher  
Mesureur de cocktail  
Medidor de cóctel

art.	ml.	col.
41604-00	20/40	●
41604G00	20/40	●
41604C00	20/40	●
41604B00	20/40	●



SS

**Japanese jigger**

Misurino cocktail  
Cocktail-Doppelmaß  
Mesure double jigger  
Medidor de cóctel

art.	ml.	col.
41604-01	20/40	●
41604G01	20/40	●
41604C01	20/40	●
41604B01	20/40	●



SS

**Long-drink shaker**

Shaker  
Shaker  
Shaker  
Coctelera

art.	Ø cm.	h. cm.	ml.	col.
41484-05	8,8	20,5	500	●
41484G05	8,8	20,5	500	●
41484C05	8,8	20,5	500	●
41484B05	8,8	20,5	500	●



SS

**Long-drink shaker**

Shaker  
Shaker  
Shaker

**Coctelera**

art.	ml.
41480-03	200
41480-05	500
41480-07	700



SS

SAN

**Long-drink shaker**

Shaker  
Shaker  
Shaker

**Coctelera**

art.	ml.	col.
41481-02	550	●
41481-03	550	●



AY

**Long-drink shaker**

Shaker  
Shaker  
Shaker

**Coctelera**

art.	ml.
41483-04	420
41483-06	660



SS

**Long-drink shaker**

Shaker  
Shaker  
Shaker

**Coctelera**

art.	Ø cm.	h. cm.	ml.	col.
41480G05	8,7	20,5	500	●
41480C05	8,7	20,5	500	●
41480B05	8,7	20,5	500	●



SS

**Shaker parisienne**

Shaker parisienne  
Shaker parisienne  
Shaker parisienne

**Coctelera parisienne**

art.	Ø cm.	h. cm.	ml.	col.
41461-07	9	23	700	●
41461G07	9	23	700	●
41461C07	9	23	700	●
41461B07	9	23	700	●



SS

**Shaker calabrese**

Shaker calabrese  
Shaker Calabrese  
Shaker calabrese  
Coctelera calabrese

art.	Ø cm.	h. cm.	ml.	col.
41464-09	9,5	24,5	900	●
41464G09	9,5	24,5	900	●
41464C09	9,5	24,5	900	●
41464B09	9,5	24,5	900	●



SS

**Boston tin + half tin**

Shaker boston 2 pz  
Boston Shaker, 2 Stk  
Shaker boston, 2 pcs  
Coctelera boston, 2 pz

art.	Ø cm.	ml.	col.
41467G08	9	790/590	●
41467C08	9	790/590	●
41467B08	9	790/590	●



SS

**Boston shaker, vinyl coated**

Cono boston, rivestimento vinile  
Boston-Shaker, Vinyl Überzug  
Shaker boston, revêtement en vinyle  
Coctelera boston, revestimiento vinilo

art.	Ø cm.	h. cm.	ml.	col.
41479-11	9	18	830	●
41479-15	9	18	830	○



SS

**Boston shaker, vinyl coated**

Cono boston, rivestimento vinile  
Boston-Shaker, Vinyl Überzug  
Shaker boston, revêtement en vinyle  
Coctelera boston, revestimiento vinilo

art.	Ø cm.	h. cm.	ml.	col.
41479-12	9	18	830	●
41479-13	9	18	830	●
41479-14	9	18	830	●



SS

**Boston shaker**

Cono boston con fondello  
Boston-Shaker  
Shaker boston  
Coctelera boston

art.	Ø cm.	h. cm.	ml.
41479-05	9	17	500



**Mixing glass**

Bicchieri vetro  
Becherglas  
Verre

Vaso vidrio

art.	Ø cm.	h. cm.	ml.
41479-AA	8,5	15	500



**Mixing glass**

Bicchieri vetro  
Becherglas  
Verre

Vaso vidrio

art.	Ø cm.	h. cm.	ml.
41478-50	8,8	15	473
41478-35	8,3	13	355



**Mixing glass**

Bicchieri vetro  
Becherglas  
Verre

Vaso vidrio

art.	Ø cm.	h. cm.	ml.
41477-50	9	15	473

With ounce markings. – Graduato in once.



**Mixing glass with lip**

Bicchieri miscelatore con becco versatore  
Rührglas mit Lippe  
Verre mélangeur avec bec verseur  
Vaso mezclador vertedor con pico

art.	Ø cm.	h. cm.	lt.
41514-05	9	16,5	0,5



**Mixing glass with lip**

Bicchieri miscelatore con becco versatore  
Rührglas mit Lippe  
Verre mélangeur avec bec verseur  
Vaso mezclador vertedor con pico

art.	Ø cm.	h. cm.	lt.
41514-10	11,5	19	0,95



PC

**Whiskey glass**

Bicchieri whiskey  
Whiskey Glas  
Verre à whiskey  
Vaso para whiskey

art.	Ø cm.	h. cm.	ml.
44940-01	8,5	9,5	420

U.Pack 6 pcs



PC

**Juice glass**

Bicchieri succo  
Fruchtsaft-Glas  
Verre à jus  
Vaso para zumo

art.	Ø cm.	h. cm.	ml.
44940-02	7,5	15,5	460

U.Pack 6 pcs



PC

**Beer glass**

Boccale birra  
Bier-Glas  
Verre à bière  
Vaso para cerveza

art.	Ø cm.	h. cm.	ml.
44940-06	8	23	450

U.Pack 6 pcs



MS

**Beer glass**

Boccale birra  
Bier-Glas  
Verre à bière  
Vaso para cerveza

art.	Ø cm.	h. cm.	ml.
44940-08	9	16	500

U.Pack 6 pcs



PC

**Margarita glass**  
Bicchiere margarita  
Margarita-Glas  
Verre à margarita  
Vaso margarita

art.	Ø cm.	h. cm.	ml.
44940-10	12	18	300

**U.Pack 6 pcs**



PC

**Martini glass**  
Bicchiere martini  
Martini-Glas  
Verre à martini  
Vaso martini

art.	Ø cm.	h. cm.	ml.
44940-11	12	17	240

**U.Pack 6 pcs**



PC

**Wine glass**  
Bicchiere vino  
Wein-Glas  
Verre à vin  
Vaso vino

art.	Ø cm.	h. cm.	ml.
44940-12	7	21	300

**U.Pack 6 pcs**



PC

**Wine glass**  
Bicchiere vino  
Wein-Glas  
Verre à vin  
Vaso vino

art.	Ø cm.	h. cm.	ml.
44940-13	7	19	200

**U.Pack 6 pcs**



PC

**Champagne glass**  
Bicchiere spumante  
Sekt-Glas  
Flûte  
Vaso champaña

art.	Ø cm.	h. cm.	ml.
44940-14	5	22	180

**U.Pack 6 pcs**



PC

**Mixing glass**  
Bicchiere  
Glas  
Verre  
Vaso

art.	Ø cm.	h. cm.	ml.
44940-16	9	16	540

**U.Pack 6 pcs**



PC

**Whiskey/rocks glass**  
Bicchiere whiskey/rocks  
Whiskey-/Rocks-Glas  
Verre à whiskey/rocks  
Vaso para whiskey/rocks

art.	Ø cm.	h. cm.	ml.
44940-17	9	12	420

**U.Pack 6 pcs**



PC

**Whiskey/rocks glass**  
Bicchiere whiskey/rocks  
Whiskey-/Rocks-Glas  
Verre à whiskey/rocks  
Vaso para whiskey/rocks

art.	Ø cm.	h. cm.	ml.
44940-18	8,5	11,5	420

U.Pack 6 pcs



PC

**Cooler**  
Bicchieri  
Glas  
Verre  
Vaso

art.	Ø cm.	h. cm.	ml.
44940-19	8	17	540

U.Pack 6 pcs



PC

**Tumbler**  
Bicchieri  
Trinkbecher  
Gobelet  
Vaso

art.	Ø cm.	h. cm.	ml.
44940-24	7,5	12,5	360
44940-25	8,0	13,5	480
44940-26	8,5	16,0	660

U.Pack 6 pcs



PC

**Tumbler**  
Bicchieri  
Trinkbecher  
Gobelet  
Vaso

art.	Ø cm.	h. cm.	ml.
44940-32	7,5	12,5	360
44940-33	8,0	13,5	480
44940-34	8,5	16,0	660

U.Pack 6 pcs



SAN

**Tumbler**  
Bicchieri  
Trinkbecher  
Gobelet  
Vaso

art.	Ø cm.	h. cm.	ml.
44990-15	5,5	9,5	150
44990-24	6,5	10,0	240
44990-29	7,0	11,0	290
44990-36	7,5	13,0	360
44990-48	8,0	15,0	480

U.Pack 6 pcs



PP

**Cover with spout**  
Coperchio con beccuccio  
Deckel mit Ausguss  
Couvercle avec bec  
Tapa con boquilla

art.	Ø cm.	U. Pack
44871-23	7	10



PC

**Water tumbler**  
Bicchieri acqua  
Wasserglas  
Verre à eau  
Vaso agua

art.	Ø cm.	h. cm.	ml.	U. Pack	col.
44871-20	7,0	7,0	170	50	○
44871-21	7,0	10,2	250	30	○
44871-22	7,8	11,4	350	30	○



NEW

PC

**Water tumbler**  
Bicchieri acqua  
Wasserglas  
Verre à eau  
Vaso agua

art.	Ø cm.	h. cm.	ml.	U. Pack	col.
44871R20	7,0	7,0	170	50	●
44871L20	7,0	7,0	170	50	●
44871G20	7,0	7,0	170	50	●
44871B20	7,0	7,0	170	50	●



**NEW**



**PC**

**Water tumbler**  
Bicchieri acqua  
Wasserglas  
Verre à eau  
Vaso agua

art.	Ø cm.	h. cm.	ml.	U. Pack	col.
44871R21	7,0	10,2	250	30	●
44871L21	7,0	10,2	250	30	●
44871G21	7,0	10,2	250	30	●
44871B21	7,0	10,2	250	30	●



**NEW**



**PC**

**Water jug**  
Caraffa  
Wasserkrug  
Crûche à eau  
Jarra

art.	dim. cm.	l.
44871-28	12x13,8	0,5
44871-30	17,4x17	1,0
44871-32	18,7x19,8	1,5
44871-34	21,6x18,8	2,0

**Withstands temperatures/Termoresistenti da: -30° +120°C.**



**NEW**

**PC**

**Lid**  
Coperchio  
Deckel  
Couvercle  
Tapa

art.	dim. cm.	fits/per	U. Pack
44871-29	9,9x1,4	l. 0,5	10
44871-31	11,2x1,9	l. 1,0	10
44871-33	14x2,4	l. 1,5	10
44871-35	15,9x2,2	l. 2,0	10

**Withstands temperatures/Termoresistenti da: -40° +100°C.**



**MS**

**Cocktail glass**  
Bicchieri cocktail  
Cocktail Glas  
Verre à cocktail  
Vaso cocktail

art.	Ø cm.	h. cm.	ml.	U. Pack
44942-01	8	21	350	6



**MS**

**Cocktail glass**  
Bicchieri cocktail  
Cocktail Glas  
Verre à cocktail  
Vaso cocktail

art.	Ø cm.	h. cm.	ml.	U. Pack
44942-02	11	21	460	6



**MS**

**Martini glass**  
Bicchieri martini  
Martini-Glas  
Verre à martini  
Vaso martini

art.	Ø cm.	h. cm.	ml.	U. Pack
44942-03	10,5	20	340	6



**MS**

**Cocktail glass**  
Bicchieri cocktail  
Cocktail Glas  
Verre à cocktail  
Vaso cocktail

art.	Ø cm.	h. cm.	ml.	U. Pack
44942-04	7,5	23	220	6



MS

**Margarita glass**

Bicchiera margarita  
Margarita-Glas  
Verre à margarita  
Vaso margarita

art.	Ø cm.	h. cm.	ml.
44942-05	12	17,5	340

U.Pack 6 pcs



SS

**Fruit basket**

Cestino agrumi  
Obstkorb  
Panier à fruits  
Cesta frutas

art.	Ø cm.	h. cm.
41611-20	21,5	20



**Orange juicer, chromed**

Spremiagrumi manuale, cromato  
Orangerpresse, verchromt  
Presse-agrumes, chromé  
Exprimidor de cítricos, cromado

art.	dim. cm.
41456-02	18x13x46



SS

**Lemon squeezer**

Spremilimone  
Zitronenpresse  
Presse citron  
Exprime limones

art.	dim. cm.
41606-00	12,5x6,5



SS

**Lemon squeezer**

Spremilimone  
Zitronenpresse  
Presse citron  
Exprime limones

art.	dim. cm.
41606-01	7x8,5



**Lemon squeezer, aluminum**

Spremilimone, alluminio  
Zitronenpresse, aluminium  
Presse citron, alu  
Exprime limones, aluminio

art.	l. cm.
41606-02	20



NEW

**Lemon/lime squeezer, aluminum**

Spremilimone/limone, alluminio  
Zitronen-/Limettenpresse, aluminium  
Presse citron, alu  
Exprimidor de limón/lima, aluminio

art.	dim. cm.
41606-22	22x7,5

3 pieces, powder coated yellow and green.  
3 pezzi, verniciato a polvere giallo e verde.



**Soda siphon**

Sifone soda  
Soda Siphon  
Siphon à eau de seltz  
Sifón agua de seltz

art.	lt.
41453-11	1



**Soda siphon**

Sifone soda  
Soda Siphon  
Siphon à eau de seltz  
Sifón agua de seltz

art.	lt.
41465-10	1



**Soda siphon**

Sifone soda  
Soda Siphon  
Siphon à eau de seltz  
Sifón agua de seltz

art.	lt.
41454-01	1



**2 Bottles Twist&Sparkle**

2 Bottiglie Twist&Sparkle  
2 Flaschen Twist&Sparkle  
2 Bouteilles Twist&Sparkle  
2 Bottiglie Twist&Sparkle

art. l. cm.  
41454-99 1



**Soda chargers, 10-pcs set**

Ricariche soda, 10 pezzi  
10-Stk. Sodakapseln-Packung  
Capsules à eau de seltz, set 10 pcs  
Cápsulas para agua de seltz, 10 pz

art. l. cm.  
41453-AA

**Content: 8 g of CO<sub>2</sub>. – Contenuto: 8 gr di CO<sub>2</sub>.**



**Ice pick**

Rompighiaccio  
Eisstößel  
Casse-glace  
Pico para hielo

art. l. cm.  
44105-00 23

**Wooden handle. – Manico legno.**



**Muddler, plastic**

Pestaghiaccio, plastica  
Eiszerstosser, Kunststoff  
Pic à glace, plastique  
Pico para hielo, plástico

art. l. cm.  
41503-22 22,5



SS

**Muddler**

Pestaghiaccio  
Eiszerstosser  
Pic à glace  
Pico para hielo

art. l. cm.  
41503-21 20



**Ice crusher, chromed**

Tritaghiaccio, cromato  
Eiswolf, verchromt  
Broyer à glace, chromé  
Trituradora de hielo, cromada

art. dim. cm.  
41457-00 15x12x26



SS

**Ice scoop**

Sessola per ghiaccio  
Eisschaufel  
Pelle à glace  
Librador para hielo

art. ml.  
41503-00 100



PC

**Ice scoop**

Sessola per ghiaccio  
Eisschaufel  
Pelle à glace  
Librador para hielo

art. ml.  
14958-01 100  
14958-02 250



SS

**Ice spoon**

Cucchiaio ghiaccio  
Eislöffel  
Cuillère à glace  
Cuchara hielo

art. l. cm.  
12550-04 22



PP

**Mold for ice-balls**

Stampo sfere di ghiaccio  
Eis-Kugel-Former  
Moule pour boules de glace  
Molde bolas de hielo

art. dim. cm.  
41515-03 24x8,5

**For 3 balls ø 5,5 cm, 100 ml.**  
Per 3 sfere ø 5,5 cm da 100 ml.



NEW

**Mold for ice-ball, silicone**

Stampo sfera di ghiaccio, silicone  
Eis-Kugel-Former, Silikon  
Moule à boule de glace, silicone  
Molde bola de hielo, silicona

art. dim. cm.  
41515-10 6,8x7,5

**For 1 ball ø 6 cm. – Per 1 sfera ø 6 cm.**



NEW

**Mold for ice-balls, silicone**

Stampo sfere di ghiaccio, silicone  
Eis-Kugel-Former, Silikon  
Moule à boules de glace, silicone  
Molde bolas de hielo, silicona

art. dim. cm.  
41515-08 12x12x5

**For 4 balls ø 4,5 cm. – Per 4 sfere ø 4,5 cm.**





NEW

**Mold for ice-balls, silicone**

Stampo sfere di ghiaccio, silicone  
Eis-Kugel-Former, Silikon  
Moule à boules de glace, silicone  
Molde bolas de hielo, silicona

art. dim. cm.

41515-09 23,5x12,8x5

For 8 balls ø 4 cm. – Per 8 sfere ø 4 cm.



**Mold for ice-skulls, silicone**

Stampo teschi ghiaccio, silicone  
Eis-Schädel-Former, Silikon  
Moule à crânes de glace, silicone  
Molde de crâneos de hielo, silicona

art. dim. cm.

41515-05 11x8



NEW

**Mold for ice-cubes, silicone**

Stampo cubetti ghiaccio, silicone  
Eiswürfel-Former, Silikon  
Moule à glaçons, silicone  
Molde cubitos de hielo, silicona

art. dim. cm.

41515-20 27x14x3,5

For 21 cubes 3 cm. – Per 21 cubetti 3 cm.



NEW

**Mold for ice-cubes, silicone**

Stampo cubetti ghiaccio, silicone  
Eiswürfel-Former, Silikon  
Moule à glaçons, silicone  
Molde cubitos de hielo, silicona

art. dim. cm.

41515-21 25x12x3

For 32 cubes 2,5 cm. – Per 32 cubetti 2,5 cm.



**Mold for ice-diamonds, silicone**

Stampo diamanti ghiaccio, silicone  
Eis-Diamant-Former, Silikon  
Moule à diamants de glace, silicone  
Molde de diamante de hielo, silicona

art. dim. cm.

41515-07 12x12

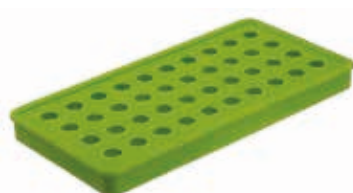

NEW

**Mold for ice-balls, silicone**

Stampo sfere di ghiaccio, silicone  
Eis-Kugel-Former, Silikon  
Moule à boules de glace, silicone  
Molde bolas de hielo, silicona

art. dim. cm.

41515-22 24x13x2

For 40 balls ø 1 cm. – Per 40 sfere ø 1 cm.





SS

**Ice tong**

Molla ghiaccio  
Eiszange  
Pince à glace  
Pinza hielo

art.	l. cm.	col.
41518G12	16	●
41518C12	16	●
41518B12	16	●



**Ice bucket with tong**

Secchio ghiaccio e pinza  
Eiseimer mit Eiszange  
Seau à glace avec pince  
Cubo hielo con pinza

art.	Ø mm.	h. cm.	lt.
41513-13	14	22	1,3

**Noble plastic jacket highly chrome plated with special insulated plastic insert.**

Camicia in materiale plastico, finitura cromata lucida con speciale inserto termico.



**Ice bucket, plastic**

Secchio ghiaccio, plastica  
Eiseimer, Kunststoff  
Seau à glace, plastique  
Cubo hielo, plástico

art.	Ø mm.	h. cm.	lt.
41512-15	15	15	1,5
41512-30	20	18	3,0

**Satin metal look with highly polished edge. Special insulated plastic insert.**

Finitura effetto metallo satinato, bordo lucido. Speciale inserto termico.



PP

SAN

**Ice box**

Secchio ghiaccio  
Eisbox  
Seau à glaçons  
Cubitera

art.	dim. cm.	lt.
41512-50	27x27x15	5,4

**With drainer. – Con griglia.**



SS

**Ice bucket**

Secchio ghiaccio  
Eisbehälter  
Seau à glace  
Cubitera hielo

art.	Ø cm.	h. cm.
46116-15	12,5	13



SS

**Ice bucket**

Secchiello ghiaccio  
Eisbehälter  
Seau à glace  
Cubitera hielo

art.	Ø cm.	h. cm.	lt.	col.
41513G20	15	14	2	●
41513C20	15	14	2	●
41513B20	15	14	2	●



**Bar organizer**

Porta oggetti da bar  
Bar-Behälter  
Présentoir de bar  
Dispensador bar

art.	dim. cm.
44102-24	24x14,5x11



SS

**Bar set, 5 pieces**

Set da bar, 5 pezzi  
Bar-Set, 5-tlg.  
Set 5 pièces à cocktail  
Juego 5 piezas cóctel

art.
41510-05



**Flair bottle**

Flair bottle  
Flair bottle  
Flair bottle  
Flair bottle

art.	lt.	col.
44108-01	0,75	○
44108-02	0,75	●



NEW

ABS

**Smoking gun**

Affumicatore  
Räuchergerät  
Pistolet à fumer  
Ahumador aromatizador

art.	dim. cm.
49923-00	16,2x5,5x12,5

**DC6V - 3,0L/min. Ideal for flavoring and smoking liquid and solid products, such as: cocktails, vegetables, meat and fish.** – Ideale per aromatizzare e affumicare prodotti liquidi e solidi, come: cocktail, verdure, carne e pesce.



NEW

**Cocktail cover**

Cloche per affumicatore  
Cocktail Räucherlocke  
Cloche à fumée  
Campana para ahumado

art.	Ø cm.	h. cm.
49923-01	12	11
49923-02	12	16

**Wood base ø 15 cm.** – Base legno ø 15 cm.



**Skull dash bottle**

Bottiglia angostura teschio  
Schädel Dash Bottle  
Dash bottle crâne  
Dash bottle cráneo

art.	ml.
41680-03	30
41680-06	60
41680-12	120



**Atomizer dash bottle**

Bottiglia angostura spray  
Bitter Flasche Atomizer  
Vaporisateur d'angostura  
Botella angostrura spray

art.	ml.
41681-10	100



NEW

**Atomizer dash bottle**

Bottiglia angostura spray  
Bitter Flasche Atomizer  
Vaporisateur d'angostura  
Botella angostrura spray

art.	h. cm.	ml.
41681-11	15	50



NEW

**Atomizer dash bottle**

Bottiglia angostura spray  
Bitter Flasche Atomizer  
Vaporisateur d'angostura  
Botella angostrura spray

art.	Ø cm.	h. cm.	ml.	col.
41681-12	7	10	100	●



**Dash bottle**

Bottiglia angostura  
Bitter Flasche  
Dash bottle  
Botella angostrura

art.	ml.
41681-06	150





**Dash Bottle**

Bottiglia angostura  
Bitter Flasche  
Dash Bottle

Botella Angostrura

art.	dim. cm.	ml.
41681-01	6,5x6,5x10	100



**Dash Bottle**

Bottiglia angostura  
Bitter Flasche  
Dash Bottle

Botella Angostrura

art.	Ø cm.	h. cm.	ml.
41681-03	8,5	15	280



**Dash Bottle**

Bottiglia angostura  
Bitter Flasche  
Dash Bottle

Botella Angostrura

art.	dim. cm.	ml.
41681-02	6x5x15	200



**Dash Bottle**

Bottiglia angostura  
Bitter Flasche  
Dash Bottle

Botella Angostrura

art.	Ø cm.	h. cm.	ml.
41681-04	6,2	10	100



**Dash bottle pourer**

Tappo versatore  
Ausgiesser  
Bouchon verseur

Tapón vertedor

art.
41681-99

**Without pourer. – Senza dosatore.**

**Without pourer. – Senza dosatore.**



**PP**

**Store & pour container**

Contentore versatore  
Dosier-Vorratsbehälter, komplett  
Bouteille verseuse  
Recipiente vertedor

art.	Ø cm.	h. cm.	lt.	col.
44106W05	9,0	26	0,5	○
44106W10	9,0	33	1,0	○
44106W20	12,5	35	2,0	○
44106W25	12,5	39	2,5	○



**PP**

**Store & pour container**

Contentore versatore  
Dosier-Vorratsbehälter, komplett  
Bouteille verseuse  
Recipiente vertedor

art.	Ø cm.	h. cm.	lt.	col.
44106G05	9,0	26	0,5	●
44106G10	9,0	33	1,0	●
44106G20	12,5	35	2,0	●
44106G25	12,5	39	2,5	●



**PP**

**Store & pour container**

Contentore versatore  
Dosier-Vorratsbehälter, komplett  
Bouteille verseuse  
Recipiente vertedor

art.	Ø cm.	h. cm.	lt.	col.
44106Y05	9,0	26	0,5	●
44106Y10	9,0	33	1,0	●
44106Y20	12,5	35	2,0	●
44106Y25	12,5	39	2,5	●



PP

**Store & pour container**

Contentitore versatore  
Dosier-Vorratsbehälter, komplett  
Bouteille verseuse

Recipiente vertedor

art.	Ø cm.	h. cm.	lt.	col.
44106R05	9,0	26	0,5	●
44106R10	9,0	33	1,0	●
44106R20	12,5	35	2,0	●
44106R25	12,5	39	2,5	●



PP

**Store & pour container**

Contentitore versatore  
Dosier-Vorratsbehälter, komplett  
Bouteille verseuse

Recipiente vertedor

art.	Ø cm.	h. cm.	lt.	col.
44106O05	9,0	26	0,5	●
44106O10	9,0	33	1,0	●
44106O20	12,5	35	2,0	●
44106O25	12,5	39	2,5	●



PP

**Store & pour container**

Contentitore versatore  
Dosier-Vorratsbehälter, komplett  
Bouteille verseuse

Recipiente vertedor

art.	Ø cm.	h. cm.	lt.	col.
44106B05	9,0	26	0,5	●
44106B10	9,0	33	1,0	●
44106B20	12,5	35	2,0	●
44106B25	12,5	39	2,5	●



PP

**Storage canister**

Contentitore di riserva  
Vorratsbehälter  
Réipient réserve

Recipiente reserva

art.	Ø cm.	h. cm.	lt.	col.
44107W05	9,0	9,5	0,5	○
44107W10	9,0	16	1,0	○
44107W20	12,5	20	2,0	○
44107W25	12,5	23	2,5	○



PP

**Storage canister**

Contentitore di riserva  
Vorratsbehälter  
Réipient réserve

Recipiente reserva

art.	Ø cm.	h. cm.	lt.	col.
44107G05	9,0	9,5	0,5	●
44107G10	9,0	16	1,0	●
44107G20	12,5	20	2,0	●
44107G25	12,5	23	2,5	●



PP

**Storage canister**

Contentitore di riserva  
Vorratsbehälter  
Réipient réserve

Recipiente reserva

art.	Ø cm.	h. cm.	lt.	col.
44107Y05	9,0	9,5	0,5	●
44107Y10	9,0	16	1,0	●
44107Y20	12,5	20	2,0	●
44107Y25	12,5	23	2,5	●



PP

**Storage canister**

Contentitore di riserva  
Vorratsbehälter  
Réipient réserve

Recipiente reserva

art.	Ø cm.	h. cm.	lt.	col.
44107R05	9,0	9,5	0,5	●
44107R10	9,0	16	1,0	●
44107R20	12,5	20	2,0	●
44107R25	12,5	23	2,5	●



PP

**Storage canister**

Contentitore di riserva  
Vorratsbehälter  
Réipient réserve

Recipiente reserva

art.	Ø cm.	h. cm.	lt.	col.
44107O05	9,0	9,5	0,5	●
44107O10	9,0	16	1,0	●
44107O20	12,5	20	2,0	●
44107O25	12,5	23	2,5	●



PP

**Storage canister**

Contentitore di riserva  
Vorratsbehälter  
Réipient réserve

Recipiente reserva

art.	Ø cm.	h. cm.	lt.	col.
44107B05	9,0	9,5	0,5	●
44107B10	9,0	16	1,0	●
44107B20	12,5	20	2,0	●
44107B25	12,5	23	2,5	●





**Pouring container cap**

Tappo per versatore  
Dosier-Behälterstopfen  
Bouchon à bouteille verseuse  
Tapón para recipiente vertedor

art.	pcs/pz
44106-12	12



ABS

**Condiment holder**

Portacondimenti  
Bar-Beilagenbehälter  
Boîte à condiments  
Caja condimentos

art.	dim. cm.	comp.
44103-03	49x15x9	3
44103-04	49x15x9	4
44103-06	49x15x9	6



SS

**Condiment holder**

Portacondimenti  
Bar-Beilagenbehälter  
Boîte à condiments  
Caja condimentos

art.	dim. cm.	comp.
41782-04	32x16x10	4
41782-05	39x16x10	5
41782-06	47x16x10	6



**Glass rimmer**

Bordatore bicchieri  
Bar-Kombination Salz-/Zuckerumranden  
Système de givrage de verres  
Ribeteador de vasos

art.	Ø cm.
44101-03	15,5



PE

**Bar liner**

Tappeto sottobicchieri  
Gläsermatte  
Revêtement de bar  
Tapete para vasos

art.	dim. cm.
44099-03	60x1300

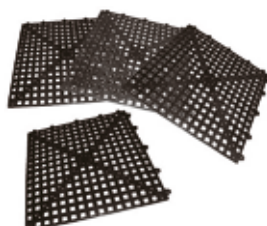

**Bar mat, non-slip**

Tappeto antiscivolo componibile  
Gläserabstellmatte, rutschfest  
Tapis antidérapant, composable  
Alfombra antiderrapante, componible

art.	dim. cm.
44100-04	30x30



**Bar runner**

Tappetino bar  
Gläserabstellmatte  
Tapis à verres  
Tapete para vasos

art.	dim. cm.
44100-01	68x8
44100-02	45x30



**Barman's set, 20 pcs**

Valigia Barman, 20 pz

Barman-Koffer, 20 Stk.

Mallette de barman, 20 pièces

Alfombra, 20 piezas

art.	des.
14480-20	Comprende/includes:
41479-05	boston shaker
41480-05	shaker
41503-22	pestello/ice beater
41595-20	cucchiaio magico/magic spoon
41603-00	colino/strainer
41604-00	misurino/measuring cup
41605-00	miscelatore/mixing spoon
41606-00	spremilimone/lemon squeezer
41606-01	spremilimone/lemon squeezer
41606-02	spremilime/lime squeezer

art.	des.
41608-04	tappo/champagne stopper
41699-06	cavatappi/corkscrew
44058-10	tappo dosatore/dispenser plug 10ml
48280-02	levacapsule/bottle opener
48280-97	coltello barman/barman knife
48280-92	rigalimoni/lemon striper
48280-96	pelarance/orange peeler
12550-04	cucchiaio ghiaccio/ice spoon
12550-36	cucchiaio bibita/cocktail spoon
12550-55	molla ghiaccio/ice tong



NEW

**Barman apron**

Grembiule barman

Barman Schurz

Tablier barman

Mandil barman

art.	dim. cm.
48543-01	70x40

65% polyester/poliestere. – 35% cotton/cotone. 195 g/mq.



NEW

**Barman apron**

Grembiule barman

Barman Schurz

Tablier barman

Mandil barman

art.	dim. cm.
48543-02	70x40

65% polyester/poliestere. – 35% cotton/cotone. 195 g/mq.





SS

**Speed rack**

Rastrelliera  
Flaschenregal  
Rack à bouteilles  
Estantería bar para botellas

art.	dim. cm.	bot.
44060-50	56x10,5x15,5	6
44060-80	81x10,5x15,5	8
44060-99	107x10,5x15,5	10



SS

**Speed rack**

Rastrelliera  
Flaschenregal  
Rack à bouteilles  
Estantería bar para botellas

art.	dim. cm.	bot.
44060-51	56x21x15,5	2x 6



SS

**Glass shelf rack**

Rastrelliera, fissaggio sospeso  
Gläserhalter Regalmontage  
Rack à verres fixation suspendue  
Rack de copas, fijación techo

art.	dim. cm.
44060-01	45x31,6x5,5



SS

**Glass wall rack**

Rastrelliera, fissaggio murale  
Gläserhalter Wandmontage  
Rack à verres fixation murale  
Rack de copas, fijación mural

art.	dim. cm.
44060-02	45x31,6x5,6



SS

**Glass cleaning brush**

Lavabicchieri  
Gläserpüleri  
Brosse lave-verres  
Cepillo lavavasos

art.	dim. cm.
44135-02	38x18x29



**Glass cleaning brush, nylon**

Spazzole lavabicchieri, nylon  
Bierglasbürstenständer, nylon  
Brosse lave-verres, nylon  
Cepillo lavavasos, nilón

art.	h. cm.
44130-02	16,5
44130-03	21,5



**Glass cleaning brush, nylon-aluminum**

Spazzola lavabicchieri, nylon-alluminio  
Bierglasbürstenständer, Nylon-Aluminium  
Brosse lave-verres, nylon-alu  
Cepillo lavavasos, nilón-aluminio

art.	Ø cm.	h. cm.
44130-01	15	19



**Aluminum wall mounter bottle rack**

Supporto a parete, alluminio  
Alu-Wandständer  
Support pour bouteilles en aluminium  
Soporte mural, aluminio

art.	l. cm.	bot.
44056-04	41	4
44056-06	67	6

**Dispensers not included. – Dosatori non inclusi.**



**Revolving bottle rack**

Supporto rotante da banco  
Theken-Drehständer vollständig  
Support rotatif de comptoir  
Soporte giratorio

art.	h. cm.	bot.
44057-04	70	4
44057-06	70	6

**Dispensers not included. – Dosatori non inclusi.**





**Standard aluminum support**

Supporto bottiglia, alluminio  
Alu-Standard Ständer,  
Support en aluminium  
Soporte de botella, aluminio

art.	col.
44056-01	●
44056-11	●
44056-21	●

**Universal fitting, shelf or wall mounting.**  
Fissaggio universale, a ripiano o parete.



**Chrome plated dispenser**

Dosatore cromato  
Verchromter Dosierer  
Doseur chromé  
Dosificador cromado

art.	ml.
44055-10	10
44055-50	50



**Chrome plated dispenser**

Dosatore cromato  
Verchromter Dosierer  
Doseur chromé  
Dosificador cromado

art.	ml.
44055-20	20
44055-25	25
44055-30	30
44055-35	35
44055-40	40



**Dispenser**

Dosatore  
Dosierer  
Doseur  
Dosificador

art.	ml.	col.
44055G30	30	●
44055G40	40	●
44055C30	30	●
44055C40	40	●



**Automatic dispenser plug**

Tappo dosatore automatico  
Automatischer Portionierer  
Bouchon doseur automatique  
Bola dosificadora

art.	ml.
44058-20	20
44058-25	25
44058-30	30



**Automatic dispenser plug**

Tappo dosatore automatico  
Automatischer Portionierer  
Bouchon doseur automatique  
Bola dosificadora

art.	ml.
44058-10	10
44058-40	40
44058-50	50



**Bottle pourer with stopper**

Tappo versatore con chiusura  
Ausgießer mit Kappe  
Bouchon avec clapet  
Tapón vertedor con clerre

art.	pcs/pz
44111-02	2

SS



**Free flow pourer**

Tappo versatore continuo  
Permanentausgießer  
Bouchon verseur continu  
Vertedor continuo

art.	pcs/pz	col.
44110-01	12	●
44110-02	12	●
44110-03	12	●



**Free flow pourer**

Tappo versatore continuo  
Permanentausgießer  
Bouchon verseur continu  
Vertedor continuo

art.	pcs/pz	col.
44110-04	12	●
44110-05	12	○
44110-06	12	●



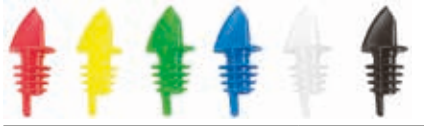

**Free flow pourer**

Tappo versatore continuo  
Permanentausgiesser  
Bouchon verseur continu  
Vertedor continuo

art.	pcs/pz
44110-00	12



**Measuring pourer**

Tappo versatore dosatore  
Dosierausgiesser  
Bouchon verseur doseur  
Tapón vertedor dosificador

art.	U. Pack	col.
44119-01	6	●
44119-02	6	●
44119-03	6	●
44119-04	6	●
44119-06	6	●



**Measuring pourer**

Tappo versatore dosatore  
Dosierausgiesser  
Bouchon verseur doseur  
Tapón vertedor dosificador

art.
44114-01
44114-02
44114-03

SS



**Measured pourer**

Tappo metrico  
Portioniererausgiesser  
Bouchon doseur  
Caños dosificador

art.	ml.	U. Pack	col.
44118-10	10	6	●
44118-20	20	6	●
44118-25	25	6	●
44118-30	30	6	●



**Measured pourer**

Tappo metrico  
Portioniererausgiesser  
Bouchon doseur  
Caños dosificador

art.	ml.	U. Pack	col.
44118-35	35	6	●
44118-40	40	6	●
44118-50	50	6	○



**Whiskey pourer**

Tappo versatore  
Ausgiesser  
Bouchon verseur  
Vertedor

art.	pcs/pz	col.
44112-01	12	●
44112-02	12	○



**Champagne stopper**

Tappo spumante  
Sektflaschenstopfen  
Bouchon à champagne  
Tapón Champaña

art.
41608-20



**Champagne stopper**

Tappo spumante  
Sektflaschenstopfen  
Bouchon à champagne  
Tapón Champaña

art.
41608-04



**Champagne stopper**

Tappo spumante  
Sektflaschenstopfen  
Bouchon à champagne  
Tapón Champaña

art.
41608-08

SS

SS



**Champagne stopper**

Tappo spumante  
Sektflaschenstopfen  
Bouchon à champagne  
Tapón Champaña

art.
41608-00



**Champagne stopper**

Tappo spumante  
Sektflaschenstopfen  
Bouchon à champagne  
Tapón Champaña

art.
46796-00



**Wine stopper**

Tappo vino  
Weinflaschenstopfen  
Bouchon à vin  
Tapón vino

art.
41608-03

SS

SS

SS



**Foil cutter**

Taglia capsula  
Folienschneider  
Coupe-capsules  
Cortacápsulas

art.

49858-07



**Winged corkscrew**

Cavatappi a doppia leva  
Korkenzieher mit Doppelhebel  
Tire-bouchon à double levier  
Sacacorchos a doble palanca

art.

41699-10



**Winged corkscrew**

Cavatappi a doppia leva  
Korkenzieher mit Doppelhebel  
Tire-bouchon à double levier  
Sacacorchos a doble palanca

art.

41699-11



**Waiter's corkscrew**

Cavatappi cameriere  
Kellner Korkenzieher  
Tire-bouchon sommelier  
Sacacorchos camarero

art.

41699-20



**Waiter's corkscrew**

Cavatappi cameriere  
Kellner Korkenzieher  
Tire-bouchon sommelier  
Sacacorchos camarero

art.

41699-06



**Lever corkscrew**

Cavatappi a leva  
Korkenzieher  
Tire-bouchon  
Sacachorcos

art.

49858-01



**Lever corkscrew**

Cavatappi a leva  
Korkenzieher  
Tire-bouchon  
Sacachorcos

art.

49858-00



**Waiter's corkscrew case**

Valigetta cameriere  
Kellner Korkenzieher-Koffer  
Mallette tire-bouchon sommelier  
Maletín sacacorchos sumiller

art.

49858-06



**Wall mounted uncorking machine**

Cavatappi da parete  
Wand-Korkenzieher  
Tire-bouchon à paroi  
Sacacorchos mural

art.

49859-00





**Bottle opener with collector box**

Levacapsule con contenitore di raccolta  
Flaschenöffner mit Sammelbehälter  
Décapsuleur avec récipient de récupération  
Abridor de botellas + caja de recuperación

art.	dim. cm.
48223-00	10,5x7,2x30



**SS**

**Bottle opener**

Levacapsule  
Flaschenöffner  
Décapsuleur  
Abrebotellas

art.	dim. cm.	col.
41699-18	18x4	●
41699G18	18x4	●
41699C18	18x4	●
41699B18	18x4	●



**SS**

**Bottle opener**

Levacapsule  
Flaschenöffner  
Décapsuleur  
Abrebotellas

art.	dim. cm.
41699-12	11x4



**SS**

**Bottle opener**

Levacapsule  
Flaschenöffner  
Décapsuleur  
Abrebotellas

art.	dim. cm.
41699-04	11x4



**Bar blade holster with belt clip**

Fondina per levacapsule  
Flaschenöffner-Halter  
Etui pour décapsuleur  
Funda para abrebotellas

art.	dim. cm.
41699-13	11x4



**Bottle opener, nickelplated**

Levacapsule nichelato  
Flaschenöffner, vernickelt  
Décapsuleur, nickelé  
Abrebotellas, niquelado

art.
41699-03



**SS**

**Etlund**

**Can punch and bottle opener**

Apriscatole/levacapsule  
Dosen-/Flaschenöffner  
Ouvre-boîte/décapsuleur  
Abrelatas/botellas

art.
49860-00



**SS**

**ABS**

**Vacuum pump wine preserver + 2 stoppers**

Pompa sottovuoto per vino + 2 tappi  
Wein-Vakuum-Pumpe + 2 Stopfen  
Pompe à vide d'air + 2 bouchons  
Bomba vacío vino + 2 tapones

art.	des.
41500-00	-
41500-AA	2 Stoppers/Tappi



**PC**

**Glass clip holder**

Clip reggibicchieri  
Glashalter  
Clip porte-verre  
Soporte para vidrio

art.	U. Pack
44048-99	100



**B**

**Noshikushi skewers**

Spiedini noshikushi  
Noshikushi Spieße  
Brochettes noshikushi  
Pinchos noshikushi

art.	l. cm.	pcs/pz
48300-42	10,5	100





W

**Toothpicks**  
Stuzzicadenti  
Zahnstocher  
Cure-dents  
Palillos

art.	l. cm.	pcs/pz
48306-01	9	1000

**Birch, double pointed, individually wrapped.**  
Betulla, 2 punte, imbastati singolarmente.



B

**Tepokushi skewers**  
Spiedini tepokushi  
Tepokushi Spieße  
Brochettes tepokushi  
Pinchos tepokushi

art.	l. cm.	pcs/pz
48300-43	9	100
48300-33	15	100



SS

**Cocktail picks, 4 pcs**  
Spiedini cocktail, 4 pz  
Cocktailspieße, 4 Stk  
Brochettes, 4 pièces  
Palos, 4 piezas

art.	l. cm.	col.
41492-00	10	●
41492G00	10	●
41492C00	10	●
41492B00	10	●



PS

**Spits, disposable**  
Spiedini, monouso  
Fleischspieße, einweg  
Brochettes, usage unique  
Palos, desechables

art.	l. cm.	pcs/pz
48364-09	9	500
48364-12	12	500



PS

**Forks, disposable**  
Forchettine monouso  
Gabeln, einweg  
Fourchettes, usage unique  
Tenedores, desechables

art.	l. cm.	pcs/pz
48362-01	8,5	500



PS

**Spoons, disposable**  
Cucchiaini monouso  
Löffel, einweg  
Cuillères, usage unique  
Cucharitas, desechables

art.	l. cm.	pcs/pz
48363-01	8,5	500



# BAR HAPPY HOUR

APPETIZERS  
AMUSE-BOUCHE



SS

**Snack holder**  
Porta snack  
Snack-Behälter  
Conteneur à snack  
Contenedor para snack

art.	Ø cm.	h. cm.	lt.
41524-09	9	8,5	0,33



SS

**Snack holder, 4 pcs**  
Porta snack, 4 pz  
Snack-Behälter, 4 Stk  
Conteneur à snack, 4 pcs  
Contenedor para snack, 4 pz

art.	Ø cm.	h. cm.	lt.
41524-04	7	6,5	0,15



SS

**Snack holder**  
Porta snack  
Snack-Behälter  
Conteneur à snack  
Contenedor para snack

art.	dim. cm.
41527-12	10x8,5x6,5
41527-13	13x10,5x9



SS

**Snack holder**  
Porta snack  
Snack-Behälter  
Conteneur à snack  
Contenedor para snack

art.	dim. cm.
41527-10	21,5x10,5x4,5
41527-11	26x13x5



SS

**Snack holder**  
Porta snack  
Snack-Behälter  
Conteneur à snack  
Contenedor para snack

art.	Ø cm.	h. cm.
41523-08	8	7,5
41523-09	9	8,5



SS

**Snack holder**  
Mini tegame  
Mini-Servierfanne  
Conteneur à snack  
Contenedor para snack

art.	dim. cm.	lt.
41522-14	14,5x9,5x4,5	0,5



SS  
PVD

**Snack holder**  
Porta snack  
Snack-Behälter  
Conteneur à snack  
Contenedor para snack

art.	dim. cm.	col.
41527G10	21,5x10,5x4,5	●
41527G11	26x13x5	●



SS  
PVD

**Snack holder**  
Porta snack  
Snack-Behälter  
Conteneur à snack  
Contenedor para snack

art.	dim. cm.	col.
41527G12	10x8,5x6,5	●
41527G13	13x10,5x9	●



SS  
PVD

**Snack holder**  
Porta snack  
Snack-Behälter  
Conteneur à snack  
Contenedor para snack

art.	Ø cm.	h. cm.	col.
41523G08	8	7,5	●
41523G09	9	8,5	●



SS

**Snack holder**  
Porta snack  
Snack-Behälter  
Conteneur à snack  
Contenedor para snack

art.	Ø cm.	h. cm.	lt.
41524-10	9,5	11,5	0,45



SS

**Snack holder**  
Porta snack  
Snack-Behälter  
Conteneur à snack  
Contenedor para snack

art.	Ø cm.	h. cm.	lt.
41524-11	8,5	8,5	0,35



SS

**Snack holder**  
Porta snack  
Snack-Behälter  
Conteneur à snack  
Contenedor para snack

art.	Ø cm.	h. cm.	lt.
41524-12	8,5	8,5	0,35



SS  
PVD

**Snack holder**  
Porta snack  
Snack-Behälter  
Conteneur à snack  
Contenedor para snack

art.	Ø cm.	h. cm.	lt.	col.
41524C10	9,5	11,5	0,45	●



SS  
PVD

**Snack holder**  
Porta snack  
Snack-Behälter  
Conteneur à snack  
Contenedor para snack

art.	Ø cm.	h. cm.	lt.	col.
41524C11	8,5	8,5	0,35	●



SS  
PVD

**Snack holder**  
Porta snack  
Snack-Behälter  
Conteneur à snack  
Contenedor para snack

art.	Ø cm.	h. cm.	lt.	col.
41524C12	8,5	8,5	0,35	●



W

**5 pcs tasting/dessert set**  
Set 5 pz aperitivo/degustazione  
5 Stück Verkostung/Dessert Set  
Set 5 pcs dégustation/dessert  
Juego de degustación/postre 5 pz

art.	dim. cm.	ml.
41205-07	42x9x1,8	4x68



W

**4 pcs canning Jar set**  
Set 4 pz Barattoli degustazione  
4 Stück Verkostung-Gläser Set  
Set 4 pcs dégustation/dessert  
Juego de degustación/postre 4 pz

art.	dim. cm.	ml.
41205-08	27,5x11x4	3x200



W

**7 pcs canning Jar set**  
Set 7 pz Barattoli degustazione  
5 Stück Verkostung-Gläser Set  
Set 7 pcs dégustation/dessert  
Juego de degustación/postre 5 pz

art.	dim. cm.	ml.
41205-09	43x10x3	6x100

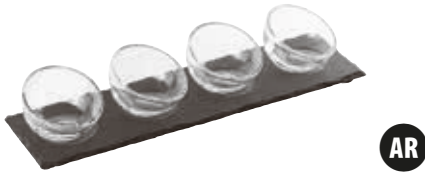

**AR**

**5 pcs tasting/dessert set**  
Set 5 pz aperitivo/degustazione  
5 Stück Verkostung/Dessert Set  
Set 5 pcs dégustation/dessert  
Juego de degustación/postre 5 pz  
.....  
art. dim. cm. ml.  
41205-01 35x10 4x43



**AR**

**5 pcs tasting/dessert set**  
Set 5 pz aperitivo/degustazione  
5 Stück Verkostung/Dessert Set  
Set 5 pcs dégustation/dessert  
Juego de degustación/postre 5 pz  
.....  
art. dim. cm. ml.  
41205-02 35x10 4x110



**W**

**5 pcs tasting/dessert set**  
Set 5 pz aperitivo/degustazione  
5 Stück Verkostung/Dessert Set  
Set 5 pcs dégustation/dessert  
Juego de degustación/postre 5 pz  
.....  
art. dim. cm. ml.  
41205-03 49x9,7x1,8 4x176



**W**

**4 pcs tasting/dessert set**  
Set 4 pz aperitivo/degustazione  
4 Stück Verkostung/Dessert Set  
Set 4 pcs dégustation/dessert  
Juego de degustación/postre 4 pz  
.....  
art. dim. cm. ml.  
41205-04 35x11x1,8 3x147



**W**

**4 pcs tasting/dessert set**  
Set 4 pz aperitivo/degustazione  
4 Stück Verkostung/Dessert Set  
Set 4 pcs dégustation/dessert  
Juego de degustación/postre 4 pz  
.....  
art. dim. cm. ml.  
41205-05 45x11x1,8 3x147



**W**

**5 pcs tasting/dessert set**  
Set 5 pz aperitivo/degustazione  
5 Stück Verkostung/Dessert Set  
Set 5 pcs dégustation/dessert  
Juego de degustación/postre 5 pz  
.....  
art. dim. cm.  
41205-06 45x9x1,8



**W**

**4 pcs tasting/dessert set**  
Set 4 pz aperitivo/degustazione  
4 Stück Verkostung/Dessert Set  
Set 4 pcs dégustation/dessert  
Juego de degustación/postre 4 pz  
.....  
art. dim. cm.  
41205-10 35x11x2



**NEW**

**W**

**7 pcs tasting/dessert set**  
Set 7 pz aperitivo/degustazione  
7 Stück Verkostung/Dessert Set  
Set 7 pcs dégustation/dessert  
Juego de degustación/postre 7 pz  
.....  
art. dim. cm.  
41206-04 38x12x1



TRAYS  
VASSOI PLANK



In reinforced polyester, suitable for food contact, dishwasher safe. Natural rough finish and elegant at the same time. They can be used as showplate and as presentation tray as well. Available in 3 colors. Non-slip foot available on request item 41323-AA.

Plance in poliestere rinforzato, idoneo al contatto alimentare, lavabile in lavastoviglie. Finitura ruvida naturale ed elegante al tempo stesso. Possono essere utilizzate come piatto presentazione e come vassoi espositivi. Disponibili in 3 colorazioni. Piedini antiscivolo in opzione art. 41323-AA.



**Tray, rectangular**  
Plancia rettangolare  
Platte, rechteckig  
Plateau rectangulaire  
Placa rectangular

art.	dim. cm.	col.
41323-11	30x20x0,5	●
41323-12	40x20x0,5	●
41323-13	40x30x0,5	●
41323-14	60x40x0,5	●



**Tray, rectangular**  
Plancia rettangolare  
Platte, rechteckig  
Plateau rectangulaire  
Placa rectangular

art.	dim. cm.	col.
41323-21	30x20x0,5	●
41323-22	40x20x0,5	●
41323-23	40x30x0,5	●
41323-24	60x40x0,5	●



**Tray, rectangular**  
Plancia rettangolare  
Platte, rechteckig  
Plateau rectangulaire  
Placa rectangular

art.	dim. cm.	col.
41323-01	30x20x0,5	●
41323-02	40x20x0,5	●
41323-03	40x30x0,5	●
41323-04	60x40x0,5	●



**Tray, round**  
Plancia rotonda  
Platte, rund  
Plateau ronde  
Placa redonda

art.	Ø cm.	h. cm.	col.
41323-16	30	0,5	●
41323-17	38	0,5	●
41323-18	40	0,5	●



**Tray, round**  
Plancia rotonda  
Platte, rund  
Plateau ronde  
Placa redonda

art.	Ø cm.	h. cm.	col.
41323-26	30	0,5	●
41323-27	38	0,5	●
41323-28	40	0,5	●



**Tray, round**  
Plancia rotonda  
Platte, rund  
Plateau ronde  
Placa redonda

art.	Ø cm.	h. cm.	col.
41323-06	30	0,5	●
41323-07	38	0,5	●
41323-08	40	0,5	●





HDPE



**Tray support**

Supporto per vassoio  
Tablett Unterstützung  
Support pour plateaux  
Soporte para bandejas

art. dim. cm. U. Pack  
41323-99 5x5x6 24



**TRAYS WOOD EFFECT**  
VASSOI EFFETTO LEGNO



MF



**Rectangular platter**

Vassoio rettangolare  
Tablett, Rechteckig  
Plateau rectangulaire  
Bandeja rectangular

art. dim. cm.  
44473-31 53x32,5x0,8  
44473-32 32,5x26,5x0,8  
44473-34 26x16x0,8  
44473-33 32,5x17,5x0,8



**Round platter**

Vassoio rotondo  
Tablett, Rund  
Plateau rond  
Bandeja redonda

art. Ø cm. h. cm.  
44473-02 33 0,8  
44473-03 43 0,8



**Round platter with handle**

Vassoio rotondo con manico  
Tablett, Rund mit Griff  
Plateau rond avec manche  
Bandeja redonda con mango

art. Ø cm. h. cm.  
44473-05 38 1,5



**Rectangular platter with handle**  
 Vassoio rettangolare con manico  
 Tablett Rechteckig mit Griff  
 Plateau rectangulaire avec manche  
 Bandeja rectangular con mango

art. dim. cm.  
 44473-07 53x20x1,5



**Rectangular platter with handle**  
 Vassoio rettangolare con manico  
 Tablett Rechteckig mit Griff  
 Plateau rectangulaire avec manche  
 Bandeja rectangular con mango

art. dim. cm.  
 44473-08 61x20x1,5



**Tray, rectangular**  
 Plancia rettangolare  
 Platte, rechteckig  
 Plateau rectangulaire  
 Placa rectangular

art. dim. cm.  
 44471-11 53x32,5x1,5  
 44471-12 32,5x26,5x1,5  
 44471-13 32,5x17,6x1,5  
 44471-14 26,5x16,2x1,5  
 44471-24 53x16,2x1,5

**WOODEN SERVING BOARDS**  
 TAGLIERI IN LEGNO



Each piece is carefully handcrafted therefore size, shape and finish may vary from piece to piece. Wash by hand with warm soapy water, do not to soak.

Ogni pezzo è realizzato a mano quindi dimensioni, forma e finitura variano da pezzo a pezzo. Lavare a mano con acqua tiepida e sapone. Non mettere in ammollo.



**Serving board**  
 Tagliere  
 Servier-Brett  
 Planche de service  
 Tabla

art. dim. cm.  
 41327-01 45,5x20

Acacia wood. – Acacia.



**Bowl**  
 Ciotola  
 Schüssel  
 Bol  
 Bol

art. Ø cm.  
 41327-02 25,5

Acacia wood. – Acacia.



**Serving board**  
 Tagliere  
 Servier-Brett  
 Planche de service  
 Tabla

art. Ø cm.  
 41327-03 20,0  
 41327-04 25,5  
 41327-05 30,5

Acacia wood. – Acacia.



**NEW**  
**W**

**Serving board**  
Tagliere  
Servier-Brett  
Planche de service  
Tabla

art.	Ø cm.
41327-06	19,5
41327-07	24,0
41327-08	29,5

**Acacia wood. – Acacia.**



**NEW**  
**W**

**Serving board**  
Tagliere  
Servier-Brett  
Planche de service  
Tabla

art.	Ø cm.
41327-09	24
41327-10	30

**Acacia wood. – Acacia.**



**W**

**Serving board**  
Tagliere  
Servier-Brett  
Planche de service  
Tabla

art.	dim. cm.
41320-25	25x17x1,5
41320-30	30x20,5x2
41320-35	35x24x2

**Olive wood. – Ulivo.**



**W**

**Serving board**  
Tagliere  
Servier-Brett  
Planche de service  
Tabla

art.	dim. cm.	l.
41321-40	40x15x1,5	40+11
41321-44	44x20x2	44+12

**Olive wood. – Ulivo.**



**W**

**Serving board**  
Tagliere  
Servier-Brett  
Planche de service  
Tabla

art.	dim. cm.	l.
41322-19	19x12,2x1,5	19+6
41322-25	25x16x1,5	25+8
41322-31	31x20x1,5	31+9

**Olive wood. – Ulivo.**



**W**

**Serving board**  
Tagliere  
Servier-Brett  
Planche de service  
Tabla

art.	dim. cm.
41325-20	20x12x3

**Birch wood. – Betulla.**



**W**

**Serving board**  
Tagliere  
Servier-Brett  
Planche de service  
Tabla

art.	dim. cm.
41325-30	30x20x3

**Birch wood. – Betulla.**



**W**

**Serving board**  
Tagliere  
Servier-Brett  
Planche de service  
Tabla

art.	dim. cm.
41325-40	40x15x3

**Birch wood. – Betulla.**



**NEW**  
**W**  
**AR**

**Serving board set 4 pieces**  
Tagliere set 4 pezzi  
Servier-Brett, 4-tlg  
Planche de service, set 4 pièces  
Tabla juego 4 piezas

art.	dim. cm.
41206-01	35x23x1,5

**Pine wood. – Pino.**



**NEW**  
**W**  
**AR**

**Serving board set 3 pieces**  
Tagliere set 3 pezzi  
Servier-Brett, 3-tlg  
Planche de service, set 3 pièces  
Tabla juego 3 piezas

art.	dim. cm.
41206-02	37x17x1,8

**Pine wood. – Pino.**



**NEW**  
**W**

**Coffee set 4 pieces**  
Servizio caffè 4 pezzi  
Kaffeaset 4 Stk  
Service à café 4 pièces  
Servicio de café 4 piezas

art.	dim. cm.
41206-03	25x18,7x2,5

**Acacia wood. – Acacia.**

**BAR HAPPY HOUR  
APPETIZERS AMUSE-BOUCHE**



AR  
W

**Serving board**  
Tagliere  
Servier-Brett  
Planche de service  
Tabla

art. dim. cm.  
41326-30 30,5x13x1,5

**Acacia wood.** – Acacia.



AR  
W

**Serving board**  
Tagliere  
Servier-Brett  
Planche de service  
Tabla

art. dim. cm.  
41326-36 36,5x15x1,5

**Acacia wood.** – Acacia.



AR  
W

**Serving board**  
Tagliere  
Servier-Brett  
Planche de service  
Tabla

art. dim. cm.  
41326-42 42x18x1,5

**Acacia wood.** – Acacia.



NEW  
W  
AR

**2-Tier serving stand**  
Alzata 2 piani  
2-stufiger Servierstand  
Support 2 niveaux  
Soporte 2 pisos

art. dim. cm.  
41207-02 25x4,5x34,5

**Beech. Slate cm. 31x13 - 41x18.** – Faggio. Ardesia cm. 31x13 - 41x18.



NEW  
W  
AR

**3-Tier serving stand**  
Alzata 3 piani  
3-stufiger Servierstand  
Support 3 niveaux  
Soporte 3 pisos

art. dim. cm.  
25x4,5x54

**Beech. Slate cm. 21x8 - 31x13 - 41x18.** – Faggio. Ardesia cm. 21x831x13 - 41x18.



W

**Service dish with porcelain surface**  
Tagliere legno con superficie porcellanata  
Servierplatte mit Porzellan-Oberfläche  
Plat à servir avec surface en porcelaine  
Tabla con superficie porcelana

art. dim. cm. Por.  
44249S30 20x30x2,5 1-2  
44249S35 25x35x2,5 1-2



W

**Service dish with porcelain surface**  
Tagliere legno con superficie porcellanata  
Servierplatte mit Porzellan-Oberfläche  
Plat à servir avec surface en porcelaine  
Tabla con superficie porcelana

art. Ø cm. Por.  
44250S30 30 1-2  
44250S35 35 1-2



W

**Platter with porcelain surface**  
Tagliere con superficie porcellanata  
Platte mit Porzellan-Oberfläche  
Plat à servir avec surface en porcelaine  
Tabla con superficie porcelana

art. dim. cm. Por.  
44248S60 60x15x2,5 4



W

**Platter with porcelain surface**  
Tagliere con superficie porcellanata  
Platte mit Porzellan-Oberfläche  
Plat à servir avec surface en porcelaine  
Tabla con superficie porcelana

art. Ø cm. h. cm. Por.  
44254-30 31 2,5 1

**Iroko wood.** – Iroko



W

**Wooden service platter**  
Tagliere legno  
Holzbrett  
Planche à Servir en bois  
Tabla madera

art. Por.  
44258-60 4-6

**Iroko wood.** – Iroko



**W**

**Wooden service platter**

Tagliere legno  
Holzbrett  
Planche à Servir en bois  
Tabla madera

art.	Ø cm.	h. cm.	Por.
44259-29	29	2,5	1-2

**Iroko wood.** – Iroko



**W**

**Wooden service platter**

Tagliere legno  
Holzbrett  
Planche à Servir en bois  
Tabla madera

art.	dim. cm.	Por.
44264-35	25x35x1,8	1-2

**Iroko wood.** – Iroko



**W**

**Wooden service platter**

Tagliere legno  
Holzbrett  
Planche à Servir en bois  
Tabla madera

art.	dim. cm.	Por.
44265-35	25x35x1,8	1-2

**Iroko wood.** – Iroko



**W**

**Wooden service platter**

Tagliere legno  
Holzbrett  
Planche à Servir en bois  
Tabla madera

art.	dim. cm.	Por.
44260-30	30x43x1,8	1-2
44260-34	34x47x1,8	2

**Iroko wood.** – Iroko



**W**

**Wooden service platter**

Tagliere legno  
Holzbrett  
Planche à Servir en bois  
Tabla madera

art.	dim. cm.	Por.
44261-46	34x46x2,5	2

**Iroko wood.** – Iroko



**W**

**Wooden service platter**

Tagliere legno  
Holzbrett  
Planche à Servir en bois  
Tabla madera

art.	dim. cm.	Por.
44262-42	26x42x2,5	1-2

**Iroko wood.** – Iroko



**W**

**Wooden service platter**

Tagliere legno  
Holzbrett  
Planche à Servir en bois  
Tabla madera

art.	dim. cm.	Por.
44263-36	14x36x3,5	1-2

**Iroko wood.** – Iroko



**W**

**Single source pot wooden platter**

Porta coppetta singolo  
Schale-Träger einzel  
Support à bol simple  
Soporte copa individual

art.	Ø cm.	dim. cm.
44256-01	5,5	8x11x1,8

**Beechwood. WITHOUT cup. See pages 343, 395, 396.** – Faggio. SENZA ciotolina. Vedi pagg. 343, 395, 396.



**W**

**Twice source pot wooden platter**

Porta coppette doppio  
Schale-Träger doppel  
Support à bol double  
Soporte copa doble

art.	Ø cm.	dim. cm.
44256-02	5,5	8x20x1,8

**Beechwood. WITHOUT cups. See pages 343, 395, 396.** – Faggio. SENZA ciotoline. Vedi pagg. 343, 395, 396.



**W**

**Triple source pot wooden platter**

Porta coppette triplo  
Schale-Träger dreifach  
Support à bol triple  
Soporte copa triple

art.	Ø cm.	dim. cm.
44256-03	5,5	8x28x1,8

**Beechwood. WITHOUT cups. See pages 343, 395, 396.** – Faggio. SENZA ciotoline. Vedi pagg. 343, 395, 396.



**W**

**Quartet source pot wooden platter**

Porta coppette quadruplo  
Schale-Träger vierfach  
Support à bol quadruple  
Soporte copa cuatro veces

art.	Ø cm.	dim. cm.
44256-04	5,5	8x36x1,8

**Beechwood. WITHOUT cups. See pages 343, 395, 396.** – Faggio. SENZA ciotoline. Vedi pagg. 343, 395, 396.

NATURAL ELEGANT



A valid alternative to glass. Elegant and unbreakable ideal for HORECA pastry and ice cream sector. Made with high quality material that confers beside resistance also glossiness and perfect transparency. Bisphenol free. Thermal tolerance -18°C +70°C. 100% recyclable material. Dishwasher safe: up to 50 washes. Made in Italy.

La valida alternativa al vetro. Eleganti ed infrangibili ideali per il settore HORECA della pasticceria e gelateria. Realizzati con materiale di alta qualità che gli conferisce oltre alla resistenza anche lucidità e trasparenza. Privi di Bisfenolo. Tolleranza termica -18°C +70°C. Materiale riciclabile al 100%. Lavabili in lavastoviglie: fino a 50 lavaggi. Prodotti made in Italy.



**NEW**  
**PS**

**Tasting glass**

Bicchierino degustazione  
Verkostung Glas  
Verrine dégustation  
Vaso degustación

art.	dim. cm.	h. cm.	ml.
48368-05	6,4x4,6	5,3	50
48368-12	8,5x6	7,0	120
48368-20	10x7	8,2	200

**Set 100 pcs. – Conf. 100 pz.**



**NEW**  
**PS**

**Tasting dish**

Piattino degustazione  
Verkostung Teller  
Assiette dégustation  
Platillo degustación

art.	Ø cm.
48372-08	8

**Set 100 pcs. – Conf. 100 pz.**



**PS**

**Tasting glass**

Bicchierino degustazione  
Verkostung Glas  
Verrine dégustation  
Vaso degustación

art.	Ø cm.	h. cm.	ml.
48353-01	8,5	6,5	120

**Set 100 pcs. – Conf. 100 pz.**



**NEW**  
**PS**

**Tasting glass**

Bicchierino degustazione  
Verkostung Glas  
Verrine dégustation  
Vaso degustación

art.	dim. cm.	h. cm.	ml.
48369-08	6,3x6,9	5,7	85
48369-14	7,3x8,1	6,7	140
48369-20	9x8,3	7,4	200

**Set 100 pcs. – Conf. 100 pz.**





**PS**

**Tasting glass**

Bicchierino degustazione  
Verkostung Glas  
Verrine dégustation  
Vaso degustación

art.	Ø cm.	h. cm.	ml.
48354-01	4	8,5	70

**Set 100 pcs. – Conf. 100 pz.**



**PS**

**Tasting bowl**

Piattino degustazione  
Verkostung Teller  
Assiette dégustation  
Platillo degustación

art.	Ø cm.	ml.
48359-01	6,5	15

**Set 100 pcs. – Conf. 100 pz.**



**PS**

**Tasting bowl**

Ciotolina degustazione  
Verkostung Schale  
Bol dégustation  
Bol degustación

art.	Ø cm.	ml.
48357-01	7,5	50

**Set 100 pcs. – Conf. 100 pz.**



**PS**

**Tasting dish**

Piattino degustazione  
Verkostung Teller  
Assiette dégustation  
Platillo degustación

art.	Ø cm.	h. cm.	ml.
48355-01	9	1,5	20

**Set 100 pcs. – Conf. 100 pz.**



**PS**

**Tasting bowl**

Ciotolina degustazione  
Verkostung Schale  
Bol dégustation  
Bol degustación

art.	Ø cm.	ml.
48356-01	8,5	30

**Set 100 pcs. – Conf. 100 pz.**



**PS**



**Tasting bowl**

Ciotolina degustazione  
Verkostung Schale  
Bol dégustation  
Bol degustación

art.	dim. cm.	ml.
48358-01	10,5x5x3	11

**Set 100 pcs. – Conf. 100 pz.**





FINGERFOOD



**Oval tweested dish**  
Ovalina goccia

art. dim. cm.  
41200-01 9x5x3



**Eye dish**  
Ovalina occhio

art. dim. cm.  
41200-02 8,1x5,6x3



**Egg dish**  
Tegamino 2/m

art. dim. cm.  
41200-03 8,5x6,8x2



**Oval dish**  
Ovalina

art. dim. cm.  
41200-04 10x5,5x2,7



**Soya sauce dish**  
Rettangolare

art. dim. cm.  
41200-05 8x5,5x1,8



**Square dish**  
Piatino quadro

art. dim. cm.  
41200-06 8x8x2,4



**Oriental square dish**  
Quadrato orientale

art. dim. cm.  
41200-07 7,5x7,5x3



**Dye dish**  
Cubo

art. dim. cm.  
41200-08 5,2x5,2x4



**Chao dish**  
Quadrato punte

art. dim. cm.  
41200-09 8x8x5



**Tear dish**  
Foglia

art. dim. cm.  
41200-10 8x7x3,4



**Nem dish**  
Tronchetto

art. dim. cm.  
41200-11 5,5x4,5x6,5



**Rectangular w/lid**  
Rettangolare c/cop

art. dim. cm.  
41200-13 10x5,5x4,5



**Square pan with lid**  
Quadra c/cop

art. dim. cm.  
41200-14 9x3,6x4,5



**Oval pan with lid**  
Ovale c/cop

art. dim. cm.  
41200-15 10,5x7x4,5



**Rectangular pan**  
Casseruola rett.

art. dim. cm.  
41200-16 10x5,5x4,5



**Square pan**  
Casseruola quadra

art. dim. cm.  
41200-17 9x3,6x4,5





**Oval pan**  
Casseruola ovale

art. dim. cm.  
41200-18 10,5x7x4,5



**Footed square dish**  
Quadrato

art. dim. cm.  
41200-32 10x10x1,2



**Fish dish**  
Piattino pesce

art. dim. cm.  
41200-33 10,5x5x1,6



**Small pan**  
Tegamino

art. dim. cm.  
41200-34 9,7x6x2,6



**Mini pasta bowl**  
Mini ciotola pasta

art. dim. cm.  
41200-36 10x2,5x1,6



**Square dish**  
Coppetta quadra

art. dim. cm.  
41200-40 7x7x3,5



**Round bowl**  
Bolo tondo

art. Ø cm. h. cm.  
41200-41 7 4,5



**Small pot**  
Mini pentola

art. dim. cm.  
41200-49 5x5x5



**Small bucket**  
Secchiello

art. dim. cm.  
41200-50 6x6x4,5



**Colander**  
Colapasta

art. dim. cm.  
41200-51 7x7x4,5



**Fruit case**  
Cassetta frutta

art. dim. cm.  
41200-52 8x5,5x2,3



**Tin with lid**  
Scatoletta c/cop

art. dim. cm.  
41200-53 13,5x5,5x5



**Tin with lid**  
Scatoletta c/cop

art. Ø cm. h. cm.  
41200-54 13,5 4



**French fries bowl**  
Vaschetta patatine

art. dim. cm.  
41200-58 13x10x4



**Rectangular w/handles**  
 Rettangolare c/m

art. dim. cm.  
41200-59 14x10x3,5



**Rectangular lid**  
Coperchio rett.

art. dim. cm.  
41200-60 14x10



**Oval w/handles**  
Ovale c/m

art. dim. cm.  
41200-61 14x9,5x3,5



**Oval lid**  
Coperchio ovale

art. dim. cm.  
41200-62 14x9,5



**Round w/handles**  
Tonda c/m

art. Ø cm. h. cm.  
41200-63 13 5,5



**Round lid**  
Coperchio tondo

art. Ø cm.  
41200-64 13



**Ramequin**  
Ramequin

art. Ø cm. h. cm.  
41200-46 10 5,0  
41200-47 9 5,0  
41200-48 8 4,5



**Vintage tray**  
Vassoietto vintage

art. dim. cm.  
41200-55 15x10x1,7



**Vintage tray**  
Vassoietto vintage

art. dim. cm.  
41200-56 22,3x14x2



**Vintage tray**  
Vassoietto vintage

art. dim. cm.  
41200-57 29,5x20,5x2

# TABLE TOP TAVOLA

SERVING ITEMS  
COMPLEMENTI



TABLE MATS & RUNNERS



Material: 50% polyester - 50% Polyvinyl chloride

Materiale: 50% Poliestere - 50% Cloruro di polivinile



**Table mat - Light melange**

Tovaglietta - Melange chiaro

art.	dim. cm.	pcs/pz
42950-01	42x33	6



**Table mat - Brown**

Tovaglietta - Marrone

art.	dim. cm.	pcs/pz
42950-04	42x33	6



**Table mat - Crispy**

Tovaglietta - Croccante

art.	dim. cm.	pcs/pz
42950-07	42x33	6



**Table mat - Sandy**

Tovaglietta - Beige

art.	dim. cm.	pcs/pz
42950-02	42x33	6

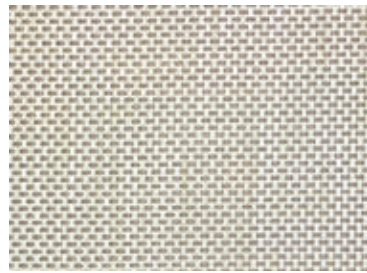

**Table mat - Beige-Grey**

Tovaglietta - Beige-Grigio

art.	dim. cm.	pcs/pz
42950-05	42x33	6



**Table mat - Coral**

Tovaglietta - Corallo

art.	dim. cm.	pcs/pz
42950-08	42x33	6

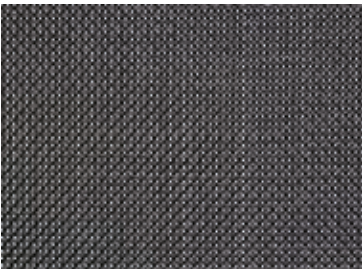

**Table mat - Black**

Tovaglietta - Nero

art.	dim. cm.	pcs/pz
42950-03	42x33	6



**Table mat - Grey**

Tovaglietta - Grigio

art.	dim. cm.	pcs/pz
42950-06	42x33	6



**Table mat - White pin-striped**

Tovaglietta - Gessato bianco

art.	dim. cm.	pcs/pz
42950-09	42x33	6



**RUNNER - Sandy  
Beige**

art.	dim. cm.
42950-92	42x180

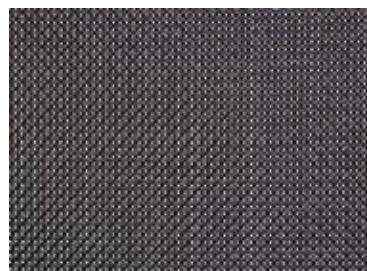

**RUNNER - Black  
Nero**

art.	dim. cm.
42950-93	42x180



**RUNNER - Brown  
Marrone**

art.	dim. cm.
42950-94	42x180



NATURAL SLATE  
ARDESIA NATURALE



Excellent coldness retention, food safe. The edges of the trays are broken to show the typical structure of the natural material. With anti-slip feet. No dishwasher proof. Material thickness: 4-7 mm.

Eccellente immagazzinamento del freddo, idonei al contatto alimentare. Gli angoli dei piani sono spezzati per evidenziare la tipica struttura del materiale. Con piedini antiscivolo. Non idonei al lavaggio in lavastoviglie. Spessore: 4-7 mm.



**Tray**  
Vassoio  
Platte  
Plateau  
Placa

art.	dim. cm.
41585-37	20x10



**Tray**  
Plancia  
Platte  
Plateau  
Placa

art.	GN	dim. cm.
41585-11	1/1	53x32,2
41585-12	1/2	32,5x26,5
41585-13	1/3	32,5x17,5
41585-24	1/4	26,5x16,5
41585-23	2/4	53x16,2



**Square tray**  
Plancia quadra  
Platte, viereckig  
Plateau carré  
Placa cuadrada

art.	dim. cm.
41585-25	25x25
41585-30	30x30



**Rectangulat tray**

Plancia rettangolare  
Platte, rechteckig  
Plateau rectangulaire  
Placa rectangular

art.	dim. cm.
41585-45	45x30



**Round tray**

Plancia tonda  
Platte, rund  
Plaque ronde  
Placa redonda

art.	Ø cm.
41586-22	22
41586-28	28
41586-33	33
41586-38	38



**Square tray, 4 pcs set**

Plancia quadra, set 4 pz  
Platte, viereckig, Satz 4 Stk  
Plateau carré, set 4 pcs  
Placa cuadrada, juego 4 pz

art.	dim. cm.
41585-10	10x10



**Tray with holes**

Vassoio con fori  
Platte mit Absätze  
Plat avec trous  
Placa con agujeros

art.	Ø cm.	dim. cm.
41585-01	6	25x12



**Tray with holes**

Vassoio con fori  
Platte mit Absätze  
Plat avec trous  
Placa con agujeros

art.	Ø cm.	dim. cm.
41585-02	6	15x8



**Tray with holes**

Vassoio con fori  
Platte mit Absätze  
Plat avec trous  
Placa con agujeros

art.	Ø cm.	dim. cm.
41585-03	6	28x10



**Tray with dome**

Piatto con campana  
Platte mit Glashaube  
Plat avec cloche  
Bandeja y campana de cristal

art.	Ø cm.	h. cm.
41585-00	10,5	8



**2 tier tray**

Alzata 2 piani  
2-stufige Etagère  
Présentoir 2 niveaux  
Bandeja dos niveles

art.	Ø cm.	h. cm.
41587-25	20-25	24



**Revolving platter**

Supporto girevole  
Servierplatt, drehbar  
Présentoir tournant  
Soporte rotatorio

art.	Ø cm.	h. cm.
41587-32	32	2,5



**Tray**

Plancia  
Platte  
Plateau  
Placa

art.	dim. cm.	fits/per
41585-51	24x15	44842-30
41585-52	47x10	44843-24
41585-53	26,5x20,5	44843-12
41585-54	32x12	44842-35

41585-52 + 44843-24



41585-54 + 44842-35



41585-53 + 44843-12



41585-51 + 44842-30



**BLACK & BROWN - FEELS LIKE CLAY**  
NERO & MARRONE - SENSAZIONE D'ARGILLA



**Black with brown edges. - Nero con bordi marrone.**

An imitation of clay, with a brown border. The surface is inside and outside fine-matt. Feels like real clay. - Una perfetta imitazione di argilla, con bordo marrone. Superficie interna ed esterna finemente opaca e con effetto argilla al tatto.



**Bowl**  
Ciotola  
Schüssel  
Bol

art.	dim. cm.	lt.
44480-00	25,5x14x5,5	0,4
44480-01	36x19x8	0,9



**Tray**  
Vassoio  
Tablett  
Plateau  
Bandeja

art.	dim. cm.
44480-03	14,5x14,5x2



**Tray**  
Vassoio  
Tablett  
Plateau  
Bandeja

art.	dim. cm.
44480-04	22,5x15x3
44480-05	27,5x11x2



**Tray**  
Vassoio  
Tablett  
Plateau  
Bandeja

art.	dim. cm.
44480-06	26,5x16,5x4



**Bowl**  
Ciotola  
Schüssel  
Bol

art.	Ø cm.	h. cm.	lt.
44480-07	8,5	2,5	0,05



**Bowl**  
Ciotola  
Schüssel  
Bol

art.	Ø cm.	h. cm.	lt.
44480-08	11,5	3	0,04



**Bowl**  
Ciotola  
Schüssel  
Bol

art.	Ø cm.	h. cm.	lt.
44480-09	11	5,5	0,2



**Bowl**  
Ciotola  
Schüssel  
Bol

art.	Ø cm.	h. cm.	lt.
44480-10	14	6,0	0,3
44480-11	19	8,0	0,8
44480-12	21	8,5	1,0
44480-13	24	9,5	1,4



**Bowl**  
Ciotola  
Schüssel  
Bol

art.	dim. cm.	lt.
44480-14	23,5x23,5x6,5	0,7





**Bowl**  
Ciotola  
Schüssel  
Bol  
Bol

art.	Ø cm.	h. cm.	lt.
44480-15	11	3,5	0,13
44480-16	14	4,0	0,20
44480-20	30,5	8,5	2,00



**Tray**  
Vassoio  
Tablett  
Plateau  
Bandeja

art.	dim. cm.
44480-17	19,5x9,5x2
44480-18	39x16x3



**Tray**  
Vassoio  
Tablett  
Plateau  
Bandeja

art.	dim. cm.
44480-19	32,5x23,5x4,5



**Soup plate**  
Piatto fondo  
Teller tief  
Assiette creuse  
Plato hondo

art.	Ø cm.	h. cm.	lt.	col.
44478-20	20,5	3	0,5	●



**Soup plate**  
Piatto fondo  
Teller tief  
Assiette creuse  
Plato hondo

art.	Ø cm.	h. cm.	lt.	col.
44478-21	20,5	3	0,5	●



**Flat plate**  
Piatto piano  
Teller flach  
Assiette plate  
Plato llano

art.	dim. cm.	col.
44478-22	14x13x2,5	●



**Flat plate**  
Piatto piano  
Teller flach  
Assiette plate  
Plato llano

art.	dim. cm.	col.
44478-23	14x13x2,5	●



**Bowl**  
Ciotola  
Schüssel  
Bol  
Bol

art.	Ø cm.	h. cm.	lt.	col.
44478-24	12,5	6	0,37	●
44478-26	16	7	0,70	●



**Bowl**  
Ciotola  
Schüssel  
Bol  
Bol

art.	Ø cm.	h. cm.	lt.	col.
44478-25	12,5	6	0,37	●
44478-27	16	7	0,70	●



**Bowl**  
Ciotola  
Schüssel  
Bol  
Bol

art.	Ø cm.	h. cm.	lt.	col.
44478-28	16,5	4	0,5	●



**Bowl**  
Ciotola  
Schüssel  
Bol  
Bol

art.	Ø cm.	h. cm.	lt.	col.
44478-29	16,5	4	0,5	●



**Bowl**  
Ciotola  
Schüssel  
Bol  
Bol

art.	Ø cm.	h. cm.	lt.	col.
44478-30	21	8	1,45	●



**Bowl**  
Ciotola  
Schüssel  
Bol  
Bol

art.	Ø cm.	h. cm.	lt.	col.
44478-31	21	8	1,45	●



**Bowl**  
Ciotola  
Schüssel  
Bol  
Bol

art.	dim. cm.	lt.	col.
44478-32	30,5x10x7,5	0,17	●
44478-34	42x14x9,5	0,65	●



**Bowl**  
Ciotola  
Schüssel  
Bol  
Bol

art.	dim. cm.	lt.	col.
44478-33	30,5x10x7,5	0,17	●
44478-35	42x14x9,5	0,65	●

GLASS JARS  
VASETTI WECK



Perfect for the sterilization and pasteurization of any product, fruit, vegetables, but also meat, fish, foie gras or delicatessen products. They are suitable for serving jams and sauces: they also look beautiful on the table. They are perfect for cooking and serving on the table. They are 100% pure glass, so they do not release harmful substances into food, they resist very high temperatures (up to 200°C in the oven), they can be washed in the dishwasher (including seal).

Perfetti per la sterilizzazione e la pastorizzazione di qualsiasi prodotto, di frutta verdura ma anche di carne, pesce, foie gras o prodotti di salumeria. Sono indicati per servire marmellate e salse di accompagnamento: inoltre belli da vedere sulla tavola. Sono i vasetti perfetti per la vasocottura e per servire in tavola. Sono al 100% in puro vetro, quindi non rilasciano sostanze nocive nel cibo, resistono a temperature elevatissime (fino a 200°C in forno), si possono lavare in lavastoviglie (guarnizione compresa).



**Set 12 glasses and cover**  
Set 12 vasetti con coperchio  
Gläser mit Deckel, 12er Set  
Set 12 verres avec couvercle  
12 vasos con tapa

art.	Ø cm.	h. cm.	ml.
41589-08	6	5,5	80
41589-14	6	7,0	140



**Set 12 glasses and cover**  
Set 12 vasetti con coperchio  
Gläser mit Deckel, 12er Set  
Set 12 verres avec couvercle  
12 vasos con tapa

art.	Ø cm.	h. cm.	ml.
41589-16	6	8	160



**Set 12 glasses and cover**  
Set 12 vasetti con coperchio  
Gläser mit Deckel, 12er Set  
Set 12 verres avec couvercle  
12 vasos con tapa

art.	Ø cm.	h. cm.	ml.
41589-22	7	8	220



**Set 12 glasses and cover**

Set 12 vasetti con coperchio  
Gläser mit Deckel, 12er Set  
Set 12 verres avec couvercle  
12 vasos con tapa

art.	Ø cm.	h. cm.	ml.
41589-20	9	6	200



**Set 2 glasses and cover**

Set 2 vasetti con coperchio  
Gläser mit Deckel, 2er Set  
Set 2 verres avec couvercle  
2 vasos con tapa

art.	Ø cm.	h. cm.	ml.
41589-58	11	11	580



**Set 3 glasses and cover**

Set 3 vasetti con coperchio  
Gläser mit Deckel, 3er Set  
Set 3 verres avec couvercle  
3 vasos con tapa

art.	Ø cm.	h. cm.	ml.
41589-37	11	7,5	370



**Set 6 bottles and cover**

Set 6 bottigliette con coperchio  
Flaschen mit Deckel, 6er Set  
Set 6 bouteilles avec couvercle  
6 botellas con tapa

art.	Ø cm.	h. cm.	ml.
41589-25	6,5	14,5	250



**Set 6 bottles and cover**

Set 6 bottigliette con coperchio  
Flaschen mit Deckel, 6er Set  
Set 6 bouteilles avec couvercle  
7 botellas con tapa

art.	Ø cm.	h. cm.	ml.
41589-50	6,5	19	500



**Set 6 bottles and cover**

Set 6 bottigliette con coperchio  
Flaschen mit Deckel, 6er Set  
Set 6 bouteilles avec couvercle  
8 botellas con tapa

art.	Ø cm.	h. cm.	ml.
41589-99	6,5	25,5	1000



**Set 10 rubber rings**

Set 10 guarnizioni  
Gummidichtringe, 10er Set  
Set 10 joints  
Juego 10 juntas

art.	Ø cm.	fits/per
41589-AA	6	41589-08-14-16
41589-BB	9	41589-20
41589-CC	11	41589-37-58



**Set 5 airtight covers**

Set 5 coperchi ermetici  
Frischhaltedeckel, 5er Set  
Set 5 couvercles hermétiques  
Juego 5 tapas herméticas

art.	Ø cm.	fits/per
41589-AC	7	41589-08-14-16
41589-AC	7	41589-25-50-99



**Set 8 cover clamps**

Set 8 clip  
Deckel-Klammer 8er Set  
Set 8 clips crochets  
Juego 8 abrazaderas

art.
41589-AB

SS



**Set 12 glasses (without lid)**

Set 12 vasetti (senza coperchi)  
Gläser, 12er Set (ohne Deckel)  
Set 12 verres (sans couvercle)  
Juego 12 vasos (sin tapa)

art.	Ø cm.	h. cm.	ml.
41589C08	6	5,5	80
41589C16	6	8,0	160



**Serving stand, chrome plated**

Supporto cromato  
Serviergestell, hartverchromt  
Présentoir, acier chromé  
Soporte, acero cromado

art.	Ø cm.	h. cm.	fits/per
44840-28	22	33	41589-08

Without glasses. – Senza vasetti.



**Serving stand, chrome plated**

Supporto cromato  
Serviergestell, hartverchromt  
Présentoir, acier chromé  
Soporte, acero cromado

art.	Ø cm.	h. cm.	fits/per
44840-27	22	59	41589-08-14-16

Without glasses. – Senza vasetti.



SS

**Insulated beverage server**

Caraffa termica  
Thermokanne  
Pot isotherme  
Jarra térmica

art.	lt.
41650-06	0,6
41650-10	1,0
41650-13	1,5



SS

**Insulated beverage server**

Caraffa termica  
Thermokanne  
Pot isotherme  
Jarra térmica

art.	lt.
41646-06	0,75
41646-10	1,00
41646-15	1,50
41646-20	2,00



SS

**Insulated beverage server**

Caraffa termica  
Thermokanne  
Pot isotherme  
Jarra térmica

art.	lt.
42401-10	1,0
42401-15	1,5
42401-20	2,0



SS

**Insulated beverage server**

Caraffa termica  
Thermokanne  
Pot isotherme  
Jarra térmica

art.	lt.
42405-10	1
42405-20	2



SS

PP

**Insulated beverage server**

Caraffa termica  
Thermokanne  
Pot isotherme  
Jarra térmica

art.	Ø cm.	h. cm.	lt.
42403-01	16	20	1

8 cups. – 8 tazze.



SS

PP

**Insulated beverage server**

Caraffa termica  
Thermokanne  
Pot isotherme  
Jarra térmica

art.	Ø cm.	h. cm.	lt.
42403B01	16	20	1

8 cups. – 8 tazze.



NEW

SS

**French press**

Caffettiera pressa filtro  
Kaffeebereiter  
Cafetière à piston  
Jarra para infusiones

art.	ml.	col.
42407-03	350	●
42407-06	600	●



PC

**Water jug**

Caraffa  
Wasserkrug  
Crûche à eau  
Jarra

art.	Ø cm.	h. cm.	lt.
44999-09	10	15	0,9
44999-16	12	20	1,6



MS

**Water jug**

Caraffa  
Wasserkrug  
Crûche à eau  
Jarra

art.	Ø cm.	h. cm.	lt.
44992-03	26	29	3



NEW



PC

**Water jug**

Caraffa  
Wasserkrug  
Crûche à eau  
Jarra

art.	dim. cm.	lt.
44871-28	12x13,8	0,5
44871-30	17,4x17	1,0
44871-32	18,7x19,8	1,5
44871-34	21,6x18,8	2,0

**Withstands temperatures/Termoresistenti da:**  
-30° +120°C.



NEW



PC

**Lid**

Coperchio  
Deckel  
Couvercle

**Tapa**

art.	dim. cm.	fits/per	U. Pack
44871-29	9,9x1,4	l. 0,5	10
44871-31	11,2x1,9	l. 1,0	10
44871-33	14x2,4	l. 1,5	10
44871-35	15,9x2,2	l. 2,0	10

**Withstands temperatures/Termoresistenti da:**  
-40° +100°C.



MS

**Water jug**

Caraffa  
Wasserkrug  
Crûche à eau  
Jarra

art.	Ø cm.	h. cm.	lt.
44994-00	14	29	2,5



MS

**Water jug**

Caraffa  
Wasserkrug  
Crûche à eau  
Jarra

art.	Ø cm.	h. cm.	lt.
44992-02	16,5	26	2



**Juice pitcher, glass**

Caraffa vetro  
Glas-Saftkanne  
Carafe à jus de fruits, verre  
Jarra zumo, vidrio

art.	Ø cm.	h. cm.	lt.
44995-15	9,5	27	1,5

**Stainless steel lid. – Coperchio inox. -10°C/+110°C**



**Juice pitcher, glass**

Caraffa vetro  
Glas-Saftkanne  
Carafe à jus de fruits, verre  
Jarra zumo, vidrio

art.	Ø cm.	h. cm.	lt.
44995-14	16	27	1,4

**Spout opens and closes automatically. Chromed foot with cooler, keep drinks chilled up to 4 hours. – Tappo apre e chiude automaticamente. Piede cromato con eutettico, mantiene le bevande refrigerate fino a 4 ore.**



**Juice pitcher, glass**

Caraffa vetro  
Glas-Saftkanne  
Carafe à jus de fruits, verre  
Jarra zumo, vidrio

art.	Ø cm.	h. cm.	lt.
44995-10	9,5	29	1

**Spout opens and closes automatically while serving. – Tappo versatore apre e chiude automaticamente.**



PC

**Juice pitcher with lid**

Caraffa con coperchio  
Saftkanne mit Deckel  
Carafe à jus avec couvercle  
Jarra zumo con tapa

art.	Ø cm.	h. cm.	lt.
44993-01	11	30	1,6



SS

**Tea strainer**  
Passathé  
Teesieb  
Passoire à thé  
Colador de tè

art. Ø cm.  
41529-05 5



SS

**Tea strainer**  
Passathé  
Teesieb  
Passoire à thé  
Colador de tè

art. Ø cm.  
41530-05 5



SS

**Tea strainer**  
Passathé  
Teesieb  
Passoire à thé  
Colador de tè

art. Ø cm.  
41530-11 5



SS

**Tea strainer**  
Passathé  
Teesieb  
Passoire à thé  
Colador de tè

art. Ø cm.  
41530-07 7,5



SS

**Tea strainer**  
Passathé  
Teesieb  
Passoire à thé  
Colador de tè

art. Ø cm.  
42617-04 4,5  
42617-05 5,0  
42617-06 6,5  
42617-07 7,5



SS

**Toast rack**  
Portatoast  
Toastständer  
Support pour toast  
Porta tostadas

art. dim. cm.  
41599-08 20x11x5,7



SS

**Egg cup**  
Portauovo  
Eierbecher  
Coquetier  
Soporte huevos

art. Ø cm.  
41598-00 8,5



MF

**Egg cup, 4 pcs set**  
Portauovo, set 4 pz  
Eierbecher, 4 Stk.  
Coquetier, set 4 pcs  
Soporte huevos, set 4 pz

art. Ø cm.  
41597-04 8,5



SS

PR

**Mustard cup**  
Senapiera  
Senfschale  
Moutardier  
Mostacero

art. Ø cm.  
41564-07 7



SS

PR

**Butter cup**  
Coppa burro  
Butterservierer  
Coupe à beurre  
Copa mantequilla

art. Ø cm.  
41563-07 7



SS

PR

**Butter cup**  
Coppa burro  
Butterservierer  
Coupe à beurre  
Copa mantequilla

art. Ø cm.  
41561-09 9



SS

**Insulated sauce boat**  
Salsiera termica  
Thermo-Sauciere, doppelwandig  
Saucière isotherme  
Salsera termica

art. dim. cm. lt.  
41620-04 19x12,5x13 0,4



SS

**Gravy boat with foot**

Salsiera  
Saucière mit Fuss  
Saucière sur pied  
Salseira con pie

art.	lt.
41615-01	0,15
41615-03	0,25
41615-05	0,45



PR

**Soup bowl**

Zuppiera testa di leone  
Suppentasse Löwenkopf  
Soupière tête de lion  
Sopera cabeza de león

art.	Ø cm.	lt.
44379-05	17	0,5



PC

**Salad bowl**

Insalatiera  
Salatschüssel  
Saladier  
Bol para ensalada

art.	Ø cm.	h. cm.	lt.
44950-15	15,2	5,0	0,6
44950-20	20,3	6,5	1,7
44950-25	25,4	8,0	3,0
44950-30	30,5	10,0	5,5
44950-38	38,1	12,5	10,6



PC

**Salad bowl**

Insalatiera  
Salatschüssel  
Saladier  
Bol para ensalada

art.	dim. cm.
44357-10	24x24x10
44357-15	24x24x15



PC

**Salad bowl**

Insalatiera  
Salatschüssel  
Saladier  
Bol para ensalada

art.	dim. cm.
44357B10	24x24x10
44357B15	24x24x15



SS

**Oval fruit basket**

Cesto frutta, ovale  
Obstschale, oval  
Panier à fruits, ovale  
Cesta fruta, oval

art.	dim. cm.
42956-19	19x15
42956-24	24,5x18
42956-28	28x21



SS

**Round fruit basket**

Cesto frutta, tondo  
Obstschale, rund  
Panier à fruits, rond  
Cesta fruta, redonda

art.	Ø cm.
41629-17	17,0
41629-20	20,0
41629-25	25,5



NEW

**Washable kraft paper bag**

Cesto pane di carta kraft lavabile  
Waschbare Kraftpapierbrottasche  
Panier en papier kraft lavable  
Cesta pan de papel kraft lavable

art.	Ø cm.	h. cm.
42879M12	12	12
42879M15	15	10
42879M22	22	13
42879M25	25	18





**Washable kraft paper bag**  
Cesto pane di carta kraft lavabile  
Waschbare Kraftpapierbrottasche  
Panier en papier kraft lavable  
Bolsa de papel kraft lavable

art.	Ø cm.	h. cm.
42879K12	12	12
42879K15	15	10
42879K22	22	13
42879K25	25	18



**Wire basket, cotton linen**  
Cesto in filo, fodera cotone  
Drahtkorb, Baumwollfutter  
Panier métallique, doublure en coton  
Cesta de alambre, forro de algodón

art.	dim. cm.
42878-17	17x12,5x8
42878-25	25x15,5x12



**Wire basket, cotton linen**  
Cesto in filo, fodera cotone  
Drahtkorb, Baumwollfutter  
Panier métallique, doublure en coton  
Cesta de alambre, forro de algodón

art.	dim. cm.
42877-17	17x12,5x8
42877-25	25x17x12



**Bread basket**  
Cesta baguettes  
Brotkorb  
Corbeille à pain  
Cesta pan

art.	Ø cm.	h. cm.
42948-18	10	7
42948-20	20	7
42948-25	25	7



**Bread basket**  
Cesta baguettes  
Brotkorb  
Corbeille à pain  
Cesta pan

art.	dim. cm.
42948-23	23x15x6,5



**Bread basket**  
Cesta baguettes  
Brotkorb  
Corbeille à pain  
Cesta pan

art.	Ø cm.	h. cm.
42935-19	19	9
42935-26	26	9



**Bread basket**  
Cesta baguettes  
Brotkorb  
Corbeille à pain  
Cesta pan

art.	Ø cm.	h. cm.
42944-23	23	7



**Bread basket**  
Cesta baguettes  
Brotkorb  
Corbeille à pain  
Cesta pan

art.	dim. cm.
42945-27	27x20x10



**Bread basket**  
Cesta baguettes  
Brotkorb  
Corbeille à pain  
Cesta pan

art.	dim. cm.
42945-18	18x13x6,5
42945-23	23x15x6,5



**Bread basket**  
Cesta baguettes  
Brotkorb  
Corbeille à pain  
Cesta pan

art.	Ø cm.	h. cm.	col.
42974C13	13	10	light beige
42974B13	13	10	brown
42974M13	13	10	dark brown
42974N13	13	10	black



**Round canvas bag**  
Cesto cotone, rotondo  
Brottasche, rund, Baumwolle  
Panier à pain rond, coton  
Cesta pan redonda, algodón

art.	Ø cm.	h. cm.
42875-17	17	8
42875-20	20	9

**Cotton, machine-washable up to 30° C.**  
Cotone, lavabile a macchina fino a 30° C.



**Round canvas bag**  
Cesto cotone, rotondo  
Brottasche, rund, Baumwolle  
Panier à pain rond, coton  
Cesta pan redonda, algodón

art.	Ø cm.	h. cm.
42875B17	17	8
42875B20	20	9

**Cotton, machine-washable up to 30° C.**  
Cotone, lavabile a macchina fino a 30° C.





**Oval canvas bag**

Cesto cotone, ovale  
Brottasche, oval, Baumwolle  
Panier à pain ovale, coton  
Cesta pan , algodón

art.	dim. cm.
42876-20	20x15x7
42876-25	25x18x9

**Cotton, machine-washable up to 30° C.**  
Cotone, lavabile a macchina fino a 30° C.



**Oval canvas bag**

Cesto cotone, ovale  
Brottasche, oval, Baumwolle  
Panier à pain ovale, coton  
Cesta pan , algodón

art.	dim. cm.
42876B20	20x15x7
42876B25	25x18x9

**Cotton, machine-washable up to 30° C.**  
Cotone, lavabile a macchina fino a 30° C.



**Round canvas bag**

Cesto cotone, rotondo  
Brottasche, rund, Baumwolle  
Panier à pain, coton  
Cesta pan, algodón

art.	Ø cm.	h. cm.	col.
42873-01	20	23,5	●

**Cherry stone pillow included. Easy to heat up in microwave for 90 sec. at 500 Watt.** – Cuscino in noccioli di ciliegio incluso. Scaldare in microonde per 90 secondi a 500 Watt.



W

**Oval bowl**

Ciotola ovale  
Schüssel, oval  
Bassine ovale  
Bol oval

art.	dim. cm.
42931-19	19,5x17



SS

**Truffle slicer**

Tagliatartufi  
Trüffelschneider  
Coupe-truffes  
Corta trufa

art.	dim. cm.	des.
48237-00	21x8,5	plain
48237-01	21x8,5	serrated



SS

**Truffle slicer**

Tagliatartufi  
Trüffelschneider  
Coupe-truffes  
Corta trufa

art.	dim. cm.	des.
48236-00	21x8,5	plain
48236-01	21x8,5	serrated

**Rosewood handle.** – Manico in palissandro.



PC

**Truffle jar**

Confezione Tuberpack  
Trüffel-Verpackung  
Réceptient à truffes  
Envasado para trufa

art.	Ø cm.	h. cm.
48237-99	6	4,5

**For transport and storage, prevents weight loss.**  
Per trasporto e conservazione, previene il calo di peso.



**Truffle server**

Servitartufi  
Trüffel-Service  
Service à truffes  
Servidor de trufas

art.	dim. cm.
48237-35	30x20x9

**Chesnut wood.** – Castagno.



SS

**Salt/pepper shaker set**

Set spargisale/pepe  
Salz- und Pfefferstreuer-Set  
Set salière et poivrier  
Juego 2 piezas sal y pimienta

art.	Ø cm.	h. cm.
42924-02	5	6,5



SS

**Condiment set 2 pcs**

Set 2 pz sale e pepe  
Menage, 2-teilig  
Ménagère 2 pcs  
Servicio de mesa, 2 piezas

art. dim. cm.  
42927-02 3x3x5



**Salt/pepper shaker, chrome top**

Spargisale/pepe cromato  
Salz-/Pfefferstreuer, verchromt  
Salière/poivrier, chromé  
Salero/pimentero, cromado

art. ml.  
42928-00 45



SS

**Salt/pepper shaker, set 12 pcs**

Spargisale/pepe, set 12 pz  
Salz-/Pfefferstreuer, 12 Stk.  
Salière/poivrier, set 12 pcs  
Salero/pimentero, juego 12 pz

art. Ø cm. h. cm.  
42926-12 3 9



SS

**Condiment set, 2 pcs**

Sale e pepe, 2 pezzi  
Menage, 2-teilig  
Ménagère, 2 pièces  
Servicio de mesa, 2 piezas

art. dim. cm.  
42929-01 11,5x5,5x17

**Wood base, satin polished handle.**  
Base legno, manico satinato.



SS

**Condiment set, 2 pcs**

Servizio oliera, 2 pezzi  
Menage, 2-teilig  
Ménagère, 2 pièces  
Servicio de mesa, 2 piezas

art. dim. cm.  
42929-02 16x7,5x24,5

**Wood base, satin polished handle.**  
Base legno, manico satinato.



SS

**Condiment set, 4 pcs**

Servizio oliera, 4 pezzi  
Menage, 4-teilig  
Ménagère, 4 pièces  
Servicio de mesa, 4 piezas

art. dim. cm.  
42929-03 15,5x12x24,5

**Wood base, satin polished handle.**  
Base legno, manico satinato.



SS

**Oil/vinegar sprayer, 2 pcs**

Nebulizzatore olio/acetato, 2 pz  
Öl-/Essigvernebler, 2 Stück  
Nébuliseur huile vinaigre, 2 pièces  
Nebulizador aceite/vinagre, 2 pz

art. Ø cm. h. cm. ml.  
41635-02 4 18 110





SS

**Oil and winegar stand**  
Porta olio/aceto  
Essig u. Öl-Stand  
Porte huile et vinaigre  
Soporte para aceite y vinagre  
art. dim. cm.  
66362-02 12,5x6x27



SS

**Oil and winegar stand**  
Porta olio/aceto  
Essig u. Öl-Stand  
Porte huile et vinaigre  
Soporte para aceite y vinagre  
art. dim. cm.  
41636-25 13x7x30



SS

**Condiment set, 4 pcs**  
Servizio oliera, 4 pezzi  
Menage, 4-teilig  
Ménagère, 4 pièces  
Servicio de mesa, 4 piezas  
art. dim. cm.  
41638-04 17,5x10,5x23



SS

**Condiment set, 2 pcs**  
Servizio oliera, 2 pezzi  
Menage, 2-teilig  
Ménagère, 2 pièces  
Servicio de mesa, 2 piezas  
art. dim. cm.  
41638-02 14,5x8,5x23



SS

**Condiment set, 2 pcs**  
Sale e pepe, 2 pezzi  
Menage, 2-teilig  
Ménagère, 2 pièces  
Servicio de mesa, 2 piezas  
art. dim. cm.  
41638-12 10,5x6,5x16



SS

**Condiment set, 3 pcs**  
Set sale, pepe, stecchi  
Menage, 3-teilig  
Ménagère, 3 pièces  
Servicio de mesa, 3 piezas  
art. Ø cm. h. cm.  
41638-13 10,5 16



SS

**Cheese jar**  
Formaggiera  
Käsedose  
Fromagère  
Quesera  
art. Ø cm. h. cm.  
41638-01 10,5 7



SS

**Cheese shaker**  
Spargiformaggio  
Käsestreuer  
Poudreuse à fromage  
Quesera  
art. ml.  
42921-00 360



PP

**Cutlery/breadstick basket**  
Portaposate/grissini  
Besteck-/Salzstangenkorb  
Panier à couverts/grissins  
Cesta cubiertos/grissini  
art. Ø cm. h. cm.  
42584-01 12 15



PP

**Cutlery dispenser**  
Portaposate  
Besteck-Ablage  
Panier à couverts  
Cesta portacubiertos  
art. dim. cm.  
42584-02 27x10x4,5



PP

**Cutlery dispenser**  
Portaposate  
Besteck-Ablage  
Panier à couverts  
Cesta portacubiertos  
art. dim. cm.  
42584-04 53x32,5x10



PP

**Cutlery dispenser**  
Portaposate  
Besteck-Ablage  
Panier à couverts  
Cesta portacubiertos  
art. dim. cm.  
42584-05 53x32,5x9



PP

**Cutlery dispenser**  
Portaposate  
Besteck-Ablage  
Panier à couverts  
Cesta portacubiertos

art.	dim. cm.	col.
42584-06	26x18x15	●
42584-07	26x18x15	●



W

**Table caddy**  
Portacondimenti  
Tisch-Caddy  
Caddy de table  
Caddy de mesa

art.	Ø cm.	h. cm.
41639-17	17,5	8,5



W

**Cutlery dispenser**  
Portaposate  
Besteck-Ablage  
Panier à couverts  
Cesta portacubiertos

art.	Ø cm.	h. cm.
41639-11	11,5	14



W

**Table caddy 4 compartments**  
Portacondimenti 4 comparti  
Tisch-Caddy 4-Fächer  
Caddy de table 4 compartiments  
Caddy de mesa 4 compartimentos

art.	dim. cm.	col.
41639-30	17x17x10	○
41639-31	17x17x10	●
41639-32	17x17x10	●

Compartments/Scomparti 7x7 cm.



W

**Table caddy 6 compartments**  
Portacondimenti 6 comparti  
Tisch-Caddy 6-Fächer  
Caddy de table 6 compartiments  
Caddy de mesa 6 compartimentos

art.	dim. cm.	col.
41639-40	27x17x10	○
41639-41	27x17x10	●
41639-42	27x17x10	●

Compartments/Scomparti 7,5x7,5 cm.



SS

**Table-cloth clips, 4 pcs set**  
Fermatovaglia, set 4 pz  
Tischtuch Klammer, 4-Tlg  
Pincas à nappe, 4 pièces  
Pinzas para mantel, 4 piezas

art.
42953-04

For table/Per tavoli h 3 cm.



SS

**Napkin holder**  
Legatovagliolo  
Serviettenring  
Porteserviette  
Servilletero

art.
42955-00



SS

**Dome cover**  
Cloche  
Speiseglocke  
Cloche  
Cubreplatos

art.	Ø cm.	h. cm.
41560-28	29	18



SS

ABS

**Pocket crumber**

Raccoglibriciole tascabile  
Krümsammler taschenformat  
Ramasse miettes de poche  
Recogemigas de bolsillo

art. dim. cm.  
42593-00 14x2,7



SS

**Table crumber**

Raccoglibriciole a tubo  
Krümsammler  
Ramasse miettes  
Pala recogemigas

art. dim. cm.  
41679-23 23,5



NEW

**Raclette maker, 4 pans**

Macchina per raclette, 4 padelle  
Raclette Tischgerät, 4 Pfannen  
Appareil à raclette, 4 poêlons  
Máquina raclette

art. dim. cm. W  
41318-00 51x10x12 600

**Non-stick upper plate for all cooking (vegetables, meats, etc.). – Piastra superiore antiaderente per tutte le cotture (verdure, carne, ecc.).**



NEW



**Raclette maker**

Macchina per raclette  
Raclette Tischgerät  
Appareil à raclette  
Máquina raclette

art. dim. cm. W  
42420-06 44,5x21,5x30 850

**Foldable model with transport hook. 2 heating ramps, adjustable height. Suitable for cheese size 1/6 to 1/3 of a wheel. In stainless steel and painted steel. – Modello pieghevole con gancio di trasporto. 2 rampe di riscaldamento, altezza regolabile. Adatto per formaggi da 1/6 a 1/3 di una forma. In acciaio inossidabile e acciaio verniciato.**



NEW



**Raclette maker**

Macchina per raclette  
Raclette Tischgerät  
Appareil à raclette  
Máquina raclette

art. dim. cm. W  
42420-08 44,5x21,5x30 850

**Tiltable and easily removable cheese holder. Heating block adjustable height. Ideal for 6-8 people, 1/2 shape. Cheese holder in stainless steel and epoxy painted steel structure. – Porta formaggio inclinabile e facilmente rimovibile. Blocco riscaldante regolabile in altezza. Ideale per 6-8 persone, 1/2 forma. Porta formaggio in acciaio inossidabile e struttura in acciaio verniciato epossidico.**



**Fondue set, copper**

Set fonduta, rame  
Fondue-Service, Kupfer  
Service à fondue, cuivre  
Servicio para fondues, cobre

art. Ø cm. h. cm.  
15430-11 16 26



**Cheese fondue set**

Set fonduta formaggio  
Käsefondue-Service  
Service à fondue fromage  
Servicio para fondues queso

art. Ø cm. h. cm.  
41311-00 20 18



**Bourguignon fondue set**

Set fonduta bourguignonne  
Bourguignonnefondue-Service  
Service à fondue bourguignonne  
Servicio para fondues bourguignonne

art. Ø cm. h. cm.  
41312-00 20 18



**Dipping forks, 6 pcs**

Set forchette, 6 pz  
6 Stk. Fonduegäbelche  
6 curettes à fondue  
6 tenedores para fondue

art. l. cm.  
15428-06 24



SS

**Stand with grill stone**

Supporto con pietra ollare  
Träger mit Kochstein  
Pierre à cuire avec support  
Soporte con piedra

art. dim. cm.  
41315-02 17x20x12



SS

**Stand with grill stone**

Supporto con pietra ollare  
Träger mit Kochstein  
Pierre à cuire avec support  
Soporte con piedra

art. dim. cm.  
41315-04 44x20x12



NEW

SS

**Table barbecue, 1 closed side**

Barbecue da tavola, da esterno  
Tischgrill, 1 geschlossene Seite  
Barbecue de table 1 foyer fermé  
Barbacoa de mesa, 1 lado cerrado

art. dim. cm. Kg.  
41313-00 33x22x20 7,3

**Also for outdoor use. Solid beech board. Can be put in the dishwasher once disassembled.**  
Anche per uso all'esterno. Tagliere in faggio massiccio. Può essere lavato in lavastoviglie una volta smontato.



NEW

SS

**Table barbecue, 2 open sides**

Barbecue da tavola, da interno  
Tischgrill, 2 offene Seiten  
Barbecue de table 2 foyers ouverts  
Barbacoa de mesa, 2 lados abiertos

art. dim. cm. Kg.  
41314-00 33x22x20 7,3

**2 open sides for indoor use. Solid beech board. Can be put in the dishwasher once disassembled. Supplied with 1 steel pan Ø cm 18 and 1 spatula.**  
2 lati aperti per uso interno. Tagliere in faggio massiccio. Può essere lavato in lavastoviglie una volta smontato. Fornito con 1 padella di ferro Ø cm 18 e 1 spatola.



SS

**Plate warmer**

Rechaud  
Speisenwärmer  
Réchaud  
Calentador de platos

art. Ø cm. h. cm.  
41317-20 20 11

**Burning time 2 hours with an average flame.**  
Tempo di combustione 2 ore a fiamma media.



SS

**Plate warmer**

Rechaud  
Speisenwärmer  
Chauffe-plats  
Calentador de platos

art. dim. cm.  
41569-33 33x18x6,5

**Aluminum plate. – Piastra in alluminio.**



W  
SS

**Plate warmer**

Rechaud  
Speisenwärmer  
Chauffe-plats  
Calentador de platos

art.	dim. cm.
44251-01	16x16x2,5
44251-03	36x20x2,5



**Mussel pot, enamel cast-iron**

Cocotte per molluschi, ferro smaltato  
Muscheltopf, emailliertes Stahlblech  
Casserole coquillage, émaillée  
Cacerola para mejillones, esmaltada

art.	Ø cm.	h. cm.	lt.
42414-05	13,5	9,0	0,8
42414-10	18,0	12,0	2,0
42414-15	20,0	13,0	3,0
42414-20	24,0	13,5	4,0



**Trivet, cork**

Sottopentola, sughero  
Korkuntersetzer  
Sous-plat, liège  
Posavasos de corcho

art.	Ø cm.
42413-24	24



SS

**Stand with 4 skewers**

Supporto con 4 spiedini  
Träger mit 4 Fleischspiesen  
Support avec 4 brochettes  
Soporte con 4 brochetas

art.	Ø cm.	h. cm.
42417-22	22	46



SAN

**Swing table top waste bin**

Portarifiuti da tavola  
Tischeimer  
Poubelle dé table  
Papelera sobremesa, plástico

art.	Ø cm.	h. cm.
42959-13	12	18



SS

**Swing table top waste bin**

Portarifiuti da tavola  
Tischeimer  
Poubelle dé table  
Papelera sobremesa

art.	Ø cm.	h. cm.
42959-12	12	17



**Nut-cracker**

Rompinoci  
Nussknacker  
Casse-noix  
Cascanueces

art.
48211-00



SS

**Nut-cracker**

Schiaccianoci  
Nussknacker  
Casse-noix  
Cascanueces

art.	l. cm.
48210-00	16



SS

**Lobster cracker**

Pinza aragosta  
Hummerzange  
Pince à homard  
Pinza bogavante

art.	l. cm.
48239-00	20



**Lobster cracker, aluminum**

Pinza aragosta, alluminio  
Hummerzange, Aluminium  
Pince à homard, alu  
Pinza bogavante, aluminio

art.	dim. cm.
48240-00	14,5x6,5



SS

**Sea urchin cutter**

Taglia ricci di mare  
Seeigel-Messer  
Coupe oursin  
Cortador de erizo de mar

art.	dim. cm.
48286-68	6x22



SS

**Lobster pick**

Stiletto aragosta  
Hummergabel  
Curette à homard  
Tenedor bogavante

art.	l. cm.
48238-00	20



SS

**Lobster forks**

Forchettine per aragosta  
Hummergäbelchen  
Curettes à homard  
Tenedores bogavante

art.	dim. cm.	U. Pack
41594-18	18	5



SS

**Picks, set 12 pcs**

Spilloncini, set 12 pz  
Stocher, 12 Stk.  
Pic-bigorneaux, set 12 pcs  
Pico-caracoles, juego 12 pz

art.
41594-12

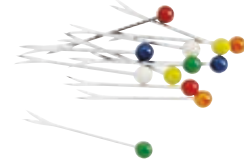

**Escargot picks, chromed, set 12 pcs**

Forchettine lumache, cromate, set 12 pz  
Schnecken gabel, verchromed, 12 Stk.  
Pic-escargots, chromés, set 12 pcs  
Pico-caracoles, cromados, juego 12 pz

art.
41686-12



SS

**Escargot dish**

Piatto lumache  
Schneckenplatte  
Plat à escargots  
Plato caracoles

art.	comp.
41687-06	6
41687-12	12



SS

**Caviar cooler**

Coppa caviale  
Kaviarkühler  
Rafraîchisseur à caviar  
Copa caviar

art.	Ø cm.	h. cm.
41562-18	18	5



**Caviar flatware, mother of pearl**

Posate caviale, madreperla  
Kaviar-Bestecke, Perlmuttern  
Couverts à caviar, nacre  
Cuberteria caviar, nácar

art.	dim. cm.	des.
41518-00	11,5	spoon
41518-01	10,5	knife
41518-02	11,5	fork



SS

**Oyster/fruit stand**

Alzata Royale  
Austern-/Obstständer  
Etagère Royale  
Expositor de mariscos/frutas

art.	Ø cm.	h. cm.
41820-03	24-33-42	50



SS

**Oyster plate**

Piatto frutti di mare  
Austernplatte  
Plat à huîtres  
Fuente de mariscos

art.	Ø cm.
41591-90	45-36



**Seafood display rack, chromed**

Supporto acciaio cromato  
Unterteil für Austernplatte, verchromt  
Support en fil chromé  
Soporte cromado para fuente mariscos

art.	Ø cm.	h. cm.
41593-20	19-25	20





**Oyster tray, aluminum**

Vassoio frutti di mare, alluminio  
Austernplatte, Aluminum  
Plat à huîtres, alu  
Fuente de mariscos, aluminio

art.	Ø cm.	h. cm.
41591-32	32	6
41591-36	36	6
41591-40	40	6
41591-45	45	6



**Oyster plate**

Piatto frutti di mare  
Austernplatte  
Plat à huîtres  
Fuente de mariscos

art.	Ø cm.	h. cm.
41592-36	36	4,0
41592-45	45	5,5

SS



**Table bag holder**

Gancio appendi borsa  
Handtaschentischhänger  
Crochet de table  
Colgador de bolso

art.
41559-04

SS



**Wine bucket table clip, chrome**

Supporto secchio da tavola, cromato  
Flaschenkühler-Tischbefestigung, verchromt  
Porte-seau à champagne, chromé  
Soporte de mesa cubo champán, cromado

art.
41558-00

Per/For: 41501-20, 41502-20.



**Wine bucket**

Secchiello vino  
Sektkühler  
Seau à champagne  
Cubo champán

art.	Ø cm.	h. cm.
41502-20	20	20

SS



**Champagne bucket, aluminum**

Secchiello champagne, alluminio  
Sektühler, Aluminum  
Seau à champagne, alu  
Cubo champán, aluminio

art.	Ø cm.	h. cm.
41501-20	20	21



SS

**Wine cooler**

Secchiello vino  
Weinkühler  
Seau à vin  
Cubo vino

art.	Ø cm.	h. cm.	bot.
46120-18	18,5	16	1/2
46120-22	20,0	21	1
46120-24	24,0	22	2



SS

**White wine cooler**

Secchio vino bianco  
Weissweinkühler  
Seau à vin blanc  
Cubo vino blanco

art.	Ø cm.	h. cm.
46118-20	20	25



SS

**Wine cooler stand**

Colonna portasecchiello  
Ständer für Weinkühler  
Support seau à champagne  
Soporte para cubo

art.	Ø cm.	h. cm.
41505-20	20	70,5



SS

**Wine cooler stand**

Colonna portasecchiello  
Ständer für Weinkühler  
Support seau à champagne  
Soporte para cubo

art.	Ø cm.	h. cm.
41505-17	17,0	64,5
41505-19	19,5	64,0



SS

**Bottle cooler**

Glacette termica  
Flaschenkühler  
Rafraîchisseur à bouteille  
Enfriador isotérmico

art.	Ø cm.	h. cm.
41508C12	12/10	20



**Bottle cooler, concrete**

Glacette, cemento  
Flaschenkühler, Beton  
Rafraîchisseur à bouteille, béton  
Enfriador, cemento

art.	Ø cm.	h. cm.
41504-19	12/10	19



SS

**Bottle cooler**

Glacette termica  
Flaschenkühler  
Rafraîchisseur à bouteille  
Enfriador isotérmico

art.	Ø cm.	h. cm.
41504-09	9,5	22,5



SS

**Bottle cooler**

Glacette termica  
Flaschenkühler  
Rafraîchisseur à bouteille  
Enfriador isotérmico

art.	Ø cm.	h. cm.
41504-10	10	21



SS

**Bottle cooler**

Glacette termica  
Flaschenkühler  
Rafraîchisseur à bouteille  
Enfriador isotérmico

art.	Ø cm.	h. cm.
41508-10	10	30



PP

**Bottle cooler**

Glacette termica  
Flaschenkühler  
Rafraîchisseur à bouteille  
Enfriador isotérmico

art.	Ø cm.	h. cm.
41504-12	12,5/10	22



PP

**Bottle cooler**

Glacette termica  
Flaschenkühler  
Rafraîchisseur à bouteille  
Enfriador isotérmico

art.	Ø cm.	h. cm.
41504-11	10	22



SAN

SS

**Bottle cooler**

Glacette termica  
Flaschenkühler  
Rafraîchisseur à bouteille  
Enfriador isotérmico

art.	Ø cm.	h. cm.
41507-01	11,5/9,5	23



SS

**Wine holder**

Versavino a molla  
Weingestell  
Porte-Bouteille  
Soporte para botella

art. Ø cm.  
41510-08 8



SS

**Wine holder**

Versavino reversibile  
Weingestell  
Porte-Bouteille  
Soporte para botella

art. l. cm.  
46123-00 17



**Wine collar, chromed**

Collare salvagoccia, cromato  
Tropfenfänger, verchromt  
Collier anti-gouttes, chromé  
Anillo anti-goteo, cromado

art.  
41511-00



SS

**Wine taster**

Tastevin  
Weinprobenschale  
Tastevin  
Catador del vino

art. Ø cm.  
41499-08 8,5



**Cognac warmer, palladium**

Scaldacognac, palladio  
Cognacwärmer, Palladium  
Réchaud à cognac, palladium  
Calentador brandy, paladio

art. h. cm.  
41678-14 14,5



SS

**Pourer**

Versatore  
Ausgießer  
Verseur  
Vertedor

art.  
41511-20



**Champagne tong, chromed**

Pinza champagne, cromata  
Champagner-Zange, verchromed  
Pince à champagne, chromée  
Pinza Champaña, cromada

art.  
41511-30



**Champagne saber**

Sciabola per Sommelier  
Champagnersäbel  
Sabra à champagne  
Sable para Champán

art. l. cm.  
41496-40 40



**Flower vase, nickel plated**

Vaso fiori, nichelato  
Blumenvase, vernickelt  
Vase à fleurs, nickelé  
Florero, zinc-niquel

art. Ø cm. h. cm.  
42942-16 4 16,5



SS

**Flower vase**

Vaso fiori  
Blumenvase  
Vase à fleurs  
Florero

art. h. cm.  
41628-15 15



AG

**Candlestick**

Candeliere  
Kerzenleuchter  
Chandelier  
Candelabro una vela

art. Ø cm. h. cm.  
32931-02 10 20,5



AG

**Candelabra 3 lights**

Candelabro 3 luci  
Kerzenleuchter, 3-flammig  
Chandelier, 3 branches  
Candelabro, 3 brazos

art.	Ø cm.	h. cm.
32931-03	10	22,5



AG

**Candelabra 5 lights**

Candelabro 5 luci  
Kerzenleuchter, 5-flammig  
Chandelier, 5 branches  
Candelabro, 5 brazos

art.	Ø cm.	h. cm.
32931-05	10	24



AG

**Candlestick**

Candeliere  
Kerzenleuchter  
Chandelier  
Candelabro una vela

art.	Ø cm.	h. cm.
32935-10	10	10
32935-22	10	22



**Candelabra 5 lights, nickel-plated**

Candelabro 5 luci, nichelato  
Kerzenleuchter, 5-flammig, vernickelt  
Chandelier, 5 branches, nickelé  
Candelabro, 5 brazos, niquelado

art.	Ø cm.	h. cm.
42443-06	17	56
42443-08	24	78



AG

**Candelabra 3 lights**

Candelabro 3 luci  
Kerzenleuchter, 3-flammig, vernickelt  
Chandelier, 3 branches  
Candelabro, 3 brazos

art.	Ø cm.	h. cm.
32935-03	11	25



AG

**Candelabra 5 lights**

Candelabro 5 luci  
Kerzenleuchter, 5-flammig  
Chandelier, 5 branches  
Candelabro, 5 brazos

art.	Ø cm.	h. cm.
32935-05	11	25



AG

**Candelabra 3 lights**

Candelabro 3 luci  
Kerzenleuchter, 3-flammig  
Chandelier, 3 branches  
Candelabro, 3 brazos

art.	Ø cm.	h. cm.
32936-03	13	39



AG

**Candelabra 5 lights**

Candelabro 5 luci  
Kerzenleuchter, 5-flammig  
Chandelier, 5 branches  
Candelabro, 5 brazos

art.	Ø cm.	h. cm.
32936-05	13	39



SS

**Candleholder satin finish, set 2 pcs**

Portacandela satinato, set 2 pz  
Windlicht, mattiert, 2er Set  
Bougeoir satin mat, set 2 pcs  
Portavela satinado, set 2 pz

art.	Ø cm.	h. cm.
42939-15	5	15



**Candleholder, chromed**

Portacandela, cromato  
Windlicht, verchromt  
Bougeoir, chromé  
Portavela, cromado

art.	Ø cm.	h. cm.
42941-22	11	22



**Set 4 tea light candles**

Set 4 candele tea light  
Kunstteelichter, 4er Set  
Set 4 bougies chauffeplat  
Set 4 velas de tè

art.	Ø cm.	h. cm.
42446-04	3,65	3,53

**Resin. Timer function 5 hours ON/19 OFF. Powered by one CR2450 alkaline battery (not incl.). Working time >50 hours. Flameless moving wick.** – Resina. Funzione timer 5 ore ON/19 OFF. 1 batteria alcalina CR2450 (non incl.). Durata > 50 ore. Stoppino mobile senza fiamma.



**Set 3 candele**

Set 3 candles  
Kunstkerzen, 3er Set  
Set 3 bougies  
Set 3 velas

art.	Ø cm.	h. cm.
42445-03	9	12,5
	9	18,0
	9	23,0

**Resin. Timer function 5 hours ON/19 OFF. Powered by 2D alkaline batteries (not incl.). Working time >800 hours. Flameless moving wick.** – Resina. Funzione timer 5 ore ON/19 OFF. 2 batterie alcaline D (non include). Durata > 800 ore. Stoppino mobile senza fiamma.



**Menu stand**

Porta menù  
Speisekartenhalter  
Porte-menu  
Portamenús

art.	dim. cm.
42951-08	8x7x2



**Table number stand, 4 pcs set**

Supporto numero tavola, set 4 pz  
Tischnummerständer, Satz 4 Stk  
Support numéro de table, set 4 pcs  
Soporte número de mesa, set 4 pz

art.	Ø cm.	h. cm.
42954-04	4	10



**Table number stand**

Supporto numero tavola  
Tischnummerständer  
Support numéro de table  
Soporte número de mesa

art.	Ø cm.	h. cm.
42954-18	7,5	18,5
42954-29	7,5	29,0
42954-46	7,5	46,0



**Card holder**

Supporto targhetta  
Kartenhalter  
Porte-cartes  
Portatarjetas

art.	dim. cm.
42952-05	6x5x3



**Table sign, 2 pcs set**

Targhetta tavola, set 2 pz  
Tischaufsteller, Satz 2 Stk  
Plaque de table, set 2 pcs  
Placa de mesa, set 2 pz

art.	dim. cm.
42951-57	5,5x5x3,5



SS

**Table sign, 2 pcs set**

Targhetta tavola, set 2 pz  
Tischaufsteller, Satz 2 Stk  
Plaque de table, set 2 pcs  
Placa de mesa, set 2 pz

art.	dim. cm.
42951-59	5,5x5x3,5



SS

**Reception bell**

Campanella reception  
Receptionsschell  
Sonette de réception  
Timbre recepción

art.	Ø cm.	h. cm.
41390-00	8,5	6



W

**Newspaper stick**

Portagiornale  
Zeitungshalter  
Canne à journaux  
Varilla portaperiodico

art.	l. cm.	col.
48287-18	75	●
48287-19	75	●



SS

**Ashtray**

Posacenere  
Aschenbecher  
Cendrier  
Cenicero

art.	Ø cm.
48247-10	10



SS

**Ashtray**

Posacenere  
Aschenbecher  
Cendrier  
Cenicero

art.	Ø cm.	h. cm.
48250-10	10	4,5
48250-12	12	4,5



PR

**Ashtray**

Posacenere  
Aschenbecher  
Cendrier  
Cenicero

art.	Ø cm.
44366-10	10



~~SS~~

**Ashtray, chrome plated**

Posacenere, cromato  
Aschenbecher, Metall hartverchromt  
Cendrier, chromé  
Cenicero, cromado

art.	Ø cm.	h. cm.
48249-13	13	10,5



MF

**Ashtray, 3 pcs set**

Posacenere, set 3 pz  
Aschenbecher, 3 Stk  
Cendrier, set 3 pièces  
Cenicero, 3 pz

art.	Ø cm.	h. cm.	col.
48251-03	8	3	●



MF

**Ashtray**

Posacenere  
Aschenbecher  
Cendrier  
Cenicero

art.	Ø cm.	h. cm.	col.
48253B09	9,5	4,5	●



MF

**Ashtray**

Posacenere  
Aschenbecher  
Cendrier  
Cenicero

art.	Ø cm.	h. cm.	col.
48253-09	9,5	4,5	○



MF

**Ashtray**

Posacenere  
Aschenbecher  
Cendrier  
Cenicero

art.	Ø cm.	h. cm.	col.
48252-10	10	4,0	○
48252-12	12	4,5	○



MF

**Ashtray**

Posacenere  
Aschenbecher  
Cendrier  
Cenicero

art.	Ø cm.	h. cm.	col.
48252B10	10	4,0	●
48252B12	12	4,5	●



**Table cigar cutter**  
Tagliasigari da tavola  
Zigarrenschneider  
Coupe-cigares  
Guillotina para puros

art. dim. cm.  
48244-07 9x4

**Double blad. Assorted models.**  
Doppia lama. Modelli assortiti.



**Table cigar cutter**  
Tagliasigari da tavola  
Zigarrenschneider  
Coupe-cigares  
Guillotina para puros

art. dim. cm.  
48244-04 4x4



**Table cigar cutter**  
Tagliasigari da tavola  
Zigarrenschneider  
Coupe-cigares  
Guillotina para puros

art. dim. cm.  
48242-09 9x4



**Cigar scissors**  
Forbice sigari  
Zigarrenscherer  
Ciseaux à cigares  
Cortador para puros

art. dim. cm.  
48245-10 10x5



**Cigar humidor**  
Vetrina sigari  
Zigarren-Vitrine  
Vitrine à cigares  
Vitrina para puros

art. dim. cm.  
48245-75 30x24x13

**Holds about 50-75 cigars in relation to the cigar ring, equipped with built-in hygrometer. Cedar interior. – Per c.ca 50-75 sigari in relazione al ring del sigaro, dotato di igrometro incorporato. Interno in cedro.**



**Cigar ashtray**  
Portasigaro con piattino  
Aschenbecher mit Zigarrenhalter  
Cendrier à cigares  
Cenicero para puros

art. Ø cm.  
48241-14 14,5



# PEUGEOT MILLS MACINE



TABLE TOP  
TAVOLA



**1810** Moulin Sous-Cratet



**1812** Scies - Saws - Sägen



**1840** 1<sup>er</sup> moulin à café  
First coffee mill  
Erste Kaffeemühle



**1874** 1<sup>er</sup> moulin à poivre de table  
First pepper mill for the table  
Erste Tisch-Pfeffermühle



**1882** Grand bi



**1890** Type 3



**1960** Peugimix



**1982** 205 un sacré numéro



**1997** 1<sup>er</sup> moulin à poivre électrique  
First electric pepper mill  
Erste elektrische Pfeffermühle



**2020** Edition 210





MECHANISMS  
MECCANISMI



PEPPER



SALT



WET SEA SALT



LONG PEPPER



CHILI PEPPER



NUTMEG



CINNAMON



FLAX SEED

**PEPPER**

Made of case-hardened steel for higher, more consistent output with fewer turns. Equipped with a helix-shaped double row of teeth that guide and hold the peppercorns for a perfect grind. The grind is essential for unlocking the full flavour of your pepper. To get the best out of your pepper grinding mechanism, we recommend to use peppercorns with a diameter of 6 mm or less. Black, white and dry green peppercorns can be ground in Peugeot pepper mills. The pink berries can be ground only if in a blend (max 15% pink) with one of these peppercorns. Dried coriander is also suitable for the pepper mechanism.

**DRY SALT**

The Peugeot salt mechanism is designed to grind cooking salt (rock salt). It is made of a special stainless steel that resists corrosion. Its shape is specifically adapted to transform dry salt crystals to a fine powder. To get the best out of your Peugeot salt grinding mechanism, you should use salt with a size of 4 mm max.

**WET SEA SALT**

For wet sea salt, a specially designed mechanism has been created because the natural consistency and moisture content do not allow the use of an ordinary salt mill. An innovative patented system enables a high-performance grind without blockage even with very humid or compressed salt. This specific mechanism is composed of 3 fins ensuring both resistance and constant output, and of a spiral that mixes the salt and guides it, ensuring a constant flow. Exclusive ceramic mechanism.

**NUTMEG**

The Peugeot nutmeg mill is equipped with a double stainless steel blade/grater and a strong claw which enables the nutmeg to be very finely ground.

**CHILI PEPPER**

The chili pepper mechanism is a Peugeot exclusive product. This patented model has a pre-cutting system and a mechanism that grinds dry chili pepper. Like the pepper grinder it has a patented treatment that protects the steel from corrosion while maintaining its sharpness and wear resistance.

**PEPE**

Realizzato in acciaio, beneficia di un trattamento che lo protegge dalla corrosione, conserva il potere tranciante e lo rende resistente all'usura. Dotato di una doppia fila di denti elicoidali che guidano i grani di pepe verso il basso. Trancia e non schiaccia i grani, per sprigionarne sottilmente sapore e profumo. Consigliamo di utilizzare grani di pepe con un diametro di 6 mm o meno. I grani di pepe neri, bianchi e verdi secchi possono essere macinati nei macinapepe Peugeot. Le bacche rosa possono essere macinate solo se in miscela (max 15% rosa). Il meccanismo del pepe è adatto anche al coriandolo essiccato.

**SALE SECCO**

Il meccanismo del sale è progettato per macinare il sale da cucina (sale grosso). È fatto di uno speciale acciaio inossidabile resistente alla corrosione. La sua forma è specificamente adattata per trasformare cristalli di sale secco in una polvere fine. Per un risultato ottimale si consiglia di usare sale con una dimensione di 4 mm max.

**SALE MARINO UMIDO**

Per il sale marino umido, è stato creato un meccanismo apposito. Un innovativo sistema brevettato consente una macinatura ad alte prestazioni senza ostruzioni anche con sale molto umido o compresso. Il meccanismo è composto da 3 alette che ne garantiscono sia la resistenza sia un rendimento costante, e di una spirale che mescola il sale e lo guida assicurandone un flusso costante. Meccanismo esclusivo in ceramica.

**NOCE MOSCATA**

La macina è dotata di una doppia lama per grattugiare in acciaio inox e di un robusto dischetto uncinato che permette di grattugiare l'intera noce molto finemente.

**PEPERONCINO**

Questo meccanismo è un prodotto esclusivo Peugeot. Il modello brevettato ha un sistema di pre-taglio e un meccanismo che permettono di macinare il peperoncino essiccato. Come il macinapepe, il meccanismo subisce un trattamento brevettato che protegge l'acciaio dalla corrosione pur mantenendo la sua affilatura e resistenza all'usura.



MECHANISMS  
MECCANISMI



**ADJUSTABLE GRINDING SYSTEM**

For electric or manual mills.

Patented precision system that enables precise grind adjustment settings. 6 pre-defined levels of grind for pepper and 6 for salt. Rotate the ring at the base of the mill and select one of the positions, each corresponding to a specific grain.

**REGOLAZIONE DELLA MACINA**

Per macine manuali ed elettriche.

Sistema brevettato che permette una regolazione predefinita della macinatura. 6 Livelli per il pepe e 6 Livelli per il sale. Ruotare l'anello alla base della macina e selezionare una delle posizioni, ognuna corrisponde ad una determinata grana.



**CLASSIC ADJUSTABLE SYSTEM**

Thumbwheel grind adjustment on electric grinders is found below the grinding mechanism. Grind adjustment nut on manual mills, turn the nut. Clockwise to obtain a finer grind, counter-clockwise to obtain a coarser grind.

**REGOLAZIONE CLASSICA**

Negli apparecchi elettrici la rotella di regolazione si trova sotto il meccanismo di macinatura. Negli apparecchi manuali la regolazione si effettua ruotando il dado/pomolino. Ruotare in senso orario per ottenere una macinatura più fine, in senso antiorario per ottenere una macinatura più grossa.



PEPPER



SALT



NEW

**EDITION 210 Pepper/salt mill**

Macina pepe/sale  
Pfeffer-/Salzmühle  
Moulin à poivre/sel  
Molinillo pimienta/sal

art-P art-S h. cm.

42686P21 42686S21 21

The iconic Paris model has been specially crafted in 210 millimeters to stylishly celebrate the brand's 210th birthday. This limited edition for 2020 features a graphical design that offers an original and contemporary interpretation of Peugeot's legacy.

L'iconico modello Paris è stato appositamente realizzato in 210 millimetri per celebrare con stile il 210° compleanno del marchio. Questa edizione limitata per il 2020 presenta un design grafico che offre un'interpretazione originale e contemporanea del patrimonio Peugeot.



NEW

SELECT  
MOULIN SUR MESURE

**PARIS ICON Pepper/salt mill**

Macina pepe/sale  
Pfeffer-/Salzmühle  
Moulin à poivre/sel  
Molinillo pimienta/sal

art-P art-S h. cm.

42687P18 42687S18 18  
42687P22 42687S22 22  
42687P30 42687S30 30

Walnut. – Noce



NEW

SELECT  
MOULIN SUR MESURE

**PARIS ICON Pepper/salt mill**

Macina pepe/sale  
Pfeffer-/Salzmühle  
Moulin à poivre/sel  
Molinillo pimienta/sal

art-P art-S h. cm.

42688P18 42688S18 18  
42688P22 42688S22 22  
42688P30 42688S30 30

Laquered black. – Laccato nero.



W

**PARIS ANTIQUE Pepper/salt mill**

Macina pepe/sale  
Pfeffer-/Salzmühle  
Moulin à poivre/sel  
Molinillo pimienta/sal

art-P art-S h. cm.

42749P18 42749S18 18  
42749P22 42749S22 22

Beech wood antique. – Faggio anticato.



W

**BISTRO ANTIQUE Pepper/salt mill**

Macina pepe/sale  
Pfeffer-/Salzmühle  
Moulin à poivre/sel  
Molinillo pimienta/sal

art-P art-S h. cm.

42705P10 42705S10 10

Beech wood antique. – Faggio anticato.





W

**PARIS Pepper/salt mill**

Macina pepe/sale  
Pfeffer-/Salzmühle  
Moulin à poivre/sel  
Molinillo pimienta/sal

art.-P	art.-S	h. cm.
42746P12	-	12
42746P18	42746S18	18
42746P22	42746S22	22
42746P30	42746S30	30
42746P40	-	40
42746P50	-	50
42746P80	-	80

**Beech wood, chocolate.** – Faggio cioccolato.



W

**PARIS Pepper/salt mill**

Macina pepe/sale  
Pfeffer-/Salzmühle  
Moulin à poivre/sel  
Molinillo pimienta/sal

art.-P	art.-S	h. cm.
42747P12	42747S12	12
42747P18	42747S18	18

**Beech wood, black lacquered.** – Faggio laccato nero.



SELECT  
MOÛTURE SUR MESURE

**PARIS Pepper/salt mill**

Macina pepe/sale  
Pfeffer-/Salzmühle  
Moulin à poivre/sel  
Molinillo pimienta/sal

art.-P	art.-S	h. cm.
42665P12	42665S12	12
42665P18	42665S18	18
42665P22	42665S22	22
42665P30	42665S30	30
42665P40	42665S40	40

**Beech wood, natural.** – Faggio naturale.



SELECT  
MOÛTURE SUR MESURE

**PARIS Pepper/salt mill**

Macina pepe/sale  
Pfeffer-/Salzmühle  
Moulin à poivre/sel  
Molinillo pimienta/sal

art.-P	art.-S	h. cm.
42666P12	42666S12	12
42666P18	42666S18	18
42666P22	42666S22	22
42666P27	42666S27	27
42666P30	42666S30	30
42666P40	42666S40	40

**Beech wood, chocolate.** – Faggio cioccolato.



SELECT  
MOÛTURE SUR MESURE

**PARIS Pepper/salt mill**

Macina pepe/sale  
Pfeffer-/Salzmühle  
Moulin à poivre/sel  
Molinillo pimienta/sal

art.-P	art.-S	h. cm.
42668P12	42668S12	12
42668P18	42668S18	18
42668P22	42668S22	22
42668P30	42668S30	30
42668P40	-	40

**Beech wood, red lacquered.** – Faggio laccato rosso.



**PARIS Pepper/salt mill**

Macina pepe/sale  
Pfeffer-/Salzmühle  
Moulin à poivre/sel  
Molinillo pimienta/sal

art.-P	art.-S	h. cm.
42667P12	42667S12	12
42667P18	42667S18	18
42667P22	42667S22	22
42667P30	42667S30	30

**Beech wood, black lacquered.** – Faggio laccato nero.



**PARIS Pepper/salt mill**

Macina pepe/sale  
Pfeffer-/Salzmühle  
Moulin à poivre/sel  
Molinillo pimienta/sal

art.-P	art.-S	h. cm.
42664P12	42664S12	12
42664P18	42664S18	18
42664P22	42664S22	22
42664P30	42664S30	30
42664P40	-	40

**Beech wood, white lacquered.** – Faggio laccato bianco.



**PARIS CHEF Pepper/salt mill**

Macina pepe/sale  
Pfeffer-/Salzmühle  
Moulin à poivre/sel  
Molinillo pimienta/sal

art.-P	art.-S	h. cm.
42674P18	42674S18	18
42674P22	42674S22	22
42674P30	42674S30	30

**Stainless steel.** – Inox.



**BISTRO CHEF Pepper/salt mill**

Macina pepe/sale  
Pfeffer-/Salzmühle  
Moulin à poivre/sel  
Molinillo pimienta/sal

art.-P	art.-S	h. cm.
42624P10	42624S10	10



**BISTRO Pepper/salt mill**

Macina pepe/sale  
Pfeffer-/Salzmühle  
Moulin à poivre/sel  
Molinillo pimienta/sal

art.-P	art.-S	h. cm.
42701-10	42703-10	10

**Beech wood, natural.** – Faggio naturale.



**BISTRO Pepper/salt mill**

Macina pepe/sale  
Pfeffer-/Salzmühle  
Moulin à poivre/sel  
Molinillo pimienta/sal

art.-P	art.-S	h. cm.
42701P10	42703S10	10

**Beech wood, white matt.** – Faggio bianco opaco.





W

**BISTRO Pepper/salt mill**

Macina pepe/sale  
Pfeffer-/Salzmühle  
Moulin à poivre/sel  
Molinillo pimienta/sal

art.-P art.-S h. cm.  
42702-10 42704-10 10

**Beech wood, chocolate.** – Faggio cioccolato.



W

**BISTRO Pepper/salt mill**

Macina pepe/sale  
Pfeffer-/Salzmühle  
Moulin à poivre/sel  
Molinillo pimienta/sal

art.-P art.-S h. cm.  
42702P10 42704S10 10

**Beech wood, black matt.** – Faggio nero opaco.



W

**CHÂTEL Pepper/salt mill**

Macina pepe/sale  
Pfeffer-/Salzmühle  
Moulin à poivre/sel  
Molinillo pimienta/sal

art.-P art.-S h. cm.  
42707P21 42707S21 21



W

**HOSTELLERIE Pepper mill**

Macina pepe  
Pfeffermühle  
Moulin à poivre  
Molinillo pimienta

art. h. cm. col.  
42741-22 22 ●  
42742-22 22 ●



NEW

**ISEN Pepper mill**

Macina pepe  
Pfeffermühle  
Moulin à poivre  
Molinillo pimienta

art.-P art.-S h. cm.  
42682P18 42682S18 18

**Beech wood, black mat.** – Faggio nero opaco.



NEW

**ISEN Pepper mill**

Macina pepe  
Pfeffermühle  
Moulin à poivre  
Molinillo pimienta

art.-P art.-S h. cm.  
42683P18 42683S18 18

**Beech wood, natural.** – Faggio naturale.





NEW

**MERIBEL Pepper mill**

Macina pepe  
Pfeffermühle  
Moulin à poivre  
Molinillo pimienta

art.-P art.-S h. cm.  
42685P14 42685S14 14

**Walnut. Cap highly matt finish, body brilliant finish in an acrylic envelope protecting the wood against humidity. – Noce. Testa finitura opaca, corpo finitura brillante racchiuso in acrilico che protegge il legno dall'umidità.**

**TABLE TOP TAVOLA  
PEUGEOT MILLS MACINE**



SS  
W

**ROYAN Pepper/salt mill**

Macina pepe/sale  
Pfeffer-/Salzmühle  
Moulin à poivre/sel  
Molinillo pimienta/sal

art.-P art.-S h. cm.  
42677P14 42677S14 14

**Beech wood. – Faggio.**



**BRASSERIE Duo, pepper/salt mill**

Duo, macinapepe/sale  
Duo, Pfeffer-/Salzmühle  
Duo, moulin à poivre/sel  
Duo, molinillo pimienta/sal

art. h. cm.  
42710-11 11

**ABS chromed/acrylic. – ABS cromato/acrilico.**



**FIDJI OLIVE Pepper/salt mill**

Macina pepe/sale  
Pfeffer-/Salzmühle  
Moulin à poivre/sel  
Molinillo pimienta/sal

art.-P art.-S h. cm.  
42676P15 42676S15 15  
42676P20 42676S20 20

**Stainless steel/olive wood. – Inox/ulivo.**



SS  
W

**FIDJI Pepper/salt mill**

Macina pepe/sale  
Pfeffer-/Salzmühle  
Moulin à poivre/sel  
Molinillo pimienta/sal

art.-P art.-S h. cm.  
42767P12 42767S12 12  
42767P15 42767S15 15  
42767P20 42767S20 20

**Beech wood, black matt. – Faggio nero opaco.**





NEW

**BALI FONTE Pepper mill**

Macina pepe  
Pfeffermühle  
Moulin à poivre  
Molinillo pimienta

art.	h. cm.	col.
42620P03	8	●
42620P04	8	●

Cast iron. – Ghisa.



NEW

**BALI FONTE Pepper mill**

Macina pepe  
Pfeffermühle  
Moulin à poivre  
Molinillo pimienta

art.	h. cm.	col.
42620P01	8	●
42620P02	8	●

Cast iron. – Ghisa.



NEW

W

**BAYA Pepper/salt mill**

Macina pepe/sale  
Pfeffer-/Salzmühle  
Moulin à poivre/sel  
Molinillo pimienta/sal

art.-P	art.-S	h. cm.
42684P08	42684S08	8



ABS

AY

**BALI Pepper mill**

Macina pepe  
Pfeffermühle  
Moulin à poivre  
Molinillo pimienta

art.	h. cm.	col.
42661-02	8	●
42661-03	8	●



ABS

AY

**BALI Salt mill**

Macina sale  
Salzmühle  
Moulin à sel  
Molinillo sal

art.	h. cm.	col.
42661-06	8	○







SS  
AY  
SELECT  
MOULIN SUR MESURE

**DAMÁN Pepper/salt mill**

Macina pepe/sale  
Pfeffer-/Salzmühle  
Moulin à poivre/sel  
Molinillo pimienta/sal

art.-P	art.-S	h. cm.
42764P16	42764S16	16
42764P21	42764S21	21



SELECT  
MOULIN SUR MESURE

**MADRAS Pepper/salt mill**

Macina pepe/sale  
Pfeffer-/Salzmühle  
Moulin à poivre/sel  
Molinillo pimienta/sal

art.-P	art.-S	h. cm.
42705P16	42705S16	16
42705P21	42705S21	21

**Beech wood chocolate/stainless steel.**  
Faggio cioccolato/innox.



AY

**CHAUMONT Pepper/salt mill**

Macina pepe/sale  
Pfeffer-/Salzmühle  
Moulin à poivre/sel  
Molinillo pimienta/sal

art.-P	art.-S	h. cm.
42798P11	42798S11	11



AY

**VITTEL Pepper/salt mill**

Macina pepe/sale  
Pfeffer-/Salzmühle  
Moulin à poivre/sel  
Molinillo pimienta/sal

art.-P	art.-S	h. cm.
42796P16	42796S16	16
42796P23	42796S23	23



AY

**NANCY Wet sea salt mill**

Macina per sale umido  
Mühle für Feuchtes Meersalz  
Moulin à sel humide  
Molinillo sal húmeda

art.	h. cm.
42728S18	18



AY

**NANCY Pepper/salt mill**

Macina pepe/sale  
Pfeffer-/Salzmühle  
Moulin à poivre/sel  
Molinillo pimienta/sal

art.-P	art.-S	h. cm.
42727-09	42728-09	9
42727-12	42728-12	12
42727-18	42728-18	18
42727-22	42728-22	22
42727-30	42728-30	30
42727-38	42728-38	38





AY  
W

**OLERON Wet sea salt mill**  
Macina per sale umido  
Mühle für Feuchtes Meersalz  
Moulin à sel humide  
Molinillo sal húmeda

art. h. cm.  
42670N14 14

**Beech wood.** – Faggio.



AY  
W

**OLERON Wet sea salt mill**  
Macina per sale umido  
Mühle für Feuchtes Meersalz  
Moulin à sel humide  
Molinillo sal húmeda

art. h. cm.  
42670B14 14

**Beech wood.** – Faggio.



AY

**MOLENE Wet sea salt mill**  
Macina per sale umido  
Mühle für Feuchtes Meersalz  
Moulin à sel humide  
Molinillo sal húmeda

art. h. cm.  
42670W14 14

**Beech wood.** – Faggio.



SS  
AY

**OSLO Pepper/salt mill**  
Macina pepe/sale  
Pfeffer-/Salzmühle  
Moulin à poivre/sel  
Molinillo pimienta/sal

art.-P art.-S h. cm.  
42678P14 42678S14 14



SS  
PR

**OSLO Wet sea salt mill**  
Macina per sale umido  
Mühle für Feuchtes Meersalz  
Moulin à sel humide  
Molinillo sal húmeda

art. h. cm.  
42678W14 14

**Beech wood.** – Faggio.



AY  
W

**OLERON Pepper/salt mill**  
Macina pepe/sale  
Pfeffer-/Salzmühle  
Moulin à poivre/sel  
Molinillo pimienta/sal

art.-P art.-S h. cm.  
42662P14 42662S14 14

**Beech wood.** – Faggio.



AY  
W

**OLERON Herbs/chili mill**  
Macina erbe/peperoncino  
Kräuter-/Paprikamühle  
Moulin à herbes/piment  
Molinillo hierbas/chile

art. h. cm.  
42662C14 14

**Beech wood.** – Faggio.



SS  
AY

**OUESSANT Pepper/salt mill**

Macina pepe/sale  
Pfeffer-/Salzmühle  
Moulin à poivre/sel  
Molinillo pimienta/sal

art.-P art.-S h. cm.  
42669P14 42669S14 14



SS  
AY

**OUESSANT Herbs/chili mill**

Macina erbe/peperoncino  
Kräuter-/Paprikamühle  
Moulin à herbes/piment  
Molinillo hierbas/chile

art. h. cm.  
42669C14 14



AY  
W

**OLERON Pepper/salt mill**

Macina pepe/sale  
Pfeffer-/Salzmühle  
Moulin à poivre/sel  
Molinillo pimienta/sal

art.-P art.-S h. cm.  
42663P14 42663S14 14

**Beech wood. – Faggio.**



AY  
W

**OLERON Herbs/chili mill**

Macina erbe/peperoncino  
Kräuter-/Paprikamühle  
Moulin à herbes/piment  
Molinillo hierbas/chile

art. h. cm.  
42663C14 14

**Beech wood. – Faggio.**



SS  
AY

**DAMAN Nutmeg mill**

Macina noce moscata  
Muskatmühle  
Moulin à mouscade  
Molinillo nuez moscada

art. h. cm.  
42764M15 15

**Magnetic stopper. Compartment for 3 nutmegs.**  
Tappo magnetico. Scompartimento per 3 noci.



SS  
W

**MADRAS Nutmeg mill**

Macina noce moscata  
Muskatmühle  
Moulin à mouscade  
Molinillo nuez moscada

art. h. cm.  
42705M15 15

**Beech wood chocolate. Magnetic stopper.**  
**Compartment for 3 nutmegs. – Faggio cioccolato.**  
Tappo magnetico. Scompartimento per 3 noci.



AY

**TIDORE Nutmeg mill**

Macina noce moscata  
Muskatmühle  
Moulin à mouscade  
Molinillo nuez moscada

art. h. cm.  
42720-00 11

**Compartment for 7/8 nutmegs.**  
Seratoio per 7/8 noci.





AY

ABS

**TERNATE Nutmeg mill, chromed**

Macina noce moscata, cromata  
Muskatmühle, verchromt  
Moulin à mouscade, chromé  
Molinillo nuez moscada, cromado

art. h. cm.

42720-01 11

**Compartment for 7/8 nutmegs.**  
Serbatoio per 7/8 noci.



AG

W

**PALACE Pepper/salt mill**

Macina pepe/sale  
Pfeffer-/Salzmühle  
Moulin à poivre/sel  
Molinillo pimienta/sal

art.-P art.-S h. cm.

42725P10 42725S10 10



AG

**MIGNONNETTE Pepper/salt mill**

Macina pepe/sale  
Pfeffer-/Salzmühle  
Moulin à poivre/sel  
Molinillo pimienta/sal

art.-P art.-S h. cm.

42723P10 42723S10 10

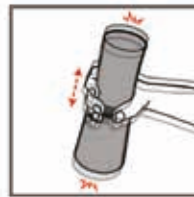

Secouer énergiquement  
Shake vigorously



Moudre  
Grind



NEW

SS

**LANKA Cinnamon shaker/mill**

Macina & spargi cannella  
Zimt Shaker-/Mühle  
Shaker et moulin à cannelle  
Especiero y molinillo de canela

art. h. cm.

42685-22 22-7

**To grind cinnamon sticks (6 cm max) - 2 functions: Shaker & Mill.**  
Per macinare bastoncini di cannella (massimo 6 cm) - 2 funzioni: Shaker & macina.



W

SS

**ISEN Flax seeds mill**

Macina semi lino/sesamo  
Leinsamen-Mühle  
Moulin à graines de lin  
Molino de semillas de lino

art. h. cm.

42680-13 13

**Supplied with spoon of 5 g. and brush.**  
Fornito con un cucchiaino da 5 g. e scovolino.





**ISEN Long pepper mill**  
Macinapepe lungo  
Langer Pfeffermühle  
Moulin à poivres longs  
Molinillo de pimienta larga

art. h. cm.  
42681-16 16

**Specially designed to grind long pepper and very large peppercorns. Also works for some dry spices (cardamom, star anise, tonka bean...). Adjustable grinding. Comes with cleaning brush.**  
Appositamente progettato per macinare pepe lungo e grani di pepe molto grandi. Funziona anche con alcune spezie secche (cardamomo, anice stellato, fava tonka ...). Macinazione regolabile. Fornito con scovolino.



**ALASKA Duo, electric pepper/salt mill**  
Duo, macinapepe/sale, elettrici  
Duo, Pfeffer-/Salzmühle  
Duo, moulin à poivre/sel  
Duo, molinillo pimienta/sal

art. h. cm.  
42660-02 17

PC/Acrylic. – PC/Acrylic.



**ONYX Pepper/salt mill**  
Macina pepe/sale  
Pfeffer-/Salzmühle  
Moulin à poivre/sel  
Molinillo pimienta/sal

art-P art-S h. cm.  
42800P20 42800S20 20

Soft touch.



**ZEPHIR Pepper/salt mill**  
Macina pepe/sale  
Pfeffer-/Salzmühle  
Moulin à poivre/sel  
Molinillo pimienta/sal

art-P art-S h. cm.  
42692B14 42693B14 14

ABS stainless steel look. Soft touch.  
ABS imitazione inox. Soft touch.



**ZELI Pepper/salt mill**  
Macina pepe/sale  
Pfeffer-/Salzmühle  
Moulin à poivre/sel  
Molinillo pimienta/sal

art-P art-S h. cm.  
42801P14 42801S14 14

ABS stainless steel look. – ABS imitazione inox.



**ELIS SENSE Pepper/salt mill**  
Macina pepe/sale  
Pfeffer-/Salzmühle  
Moulin à poivre/sel  
Molinillo pimienta/sal

art-P art-S h. cm.  
42785S20 42786S20 20

Stainless steel. Incl. small dish and spice vial with funnel. – Inox. Incl. vassoietto e fiala dosatrice con imbuto.

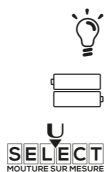

# SERIES LIVING

TABLE TOP  
TAVOLA



A complete stainless steel line, that is able to join assortment, beauty, strength and functionality. Quality items that can be used in order to set the most charming tables and buffets, but also in order to have a well-equipped kitchen. The easiest way to serve with charm any kind of dishes: from spaghetti to meat, fish, bread, vegetables, cheese and fruit. It is also indicated for tiny preparations such as sweets, olives and pickles. Nothing will unintentionally escape!

Una linea completa capace di coniugare assortimento, bellezza, robustezza e funzionalità, realizzata in acciaio inox. Oggetti di qualità per apparecchiare le tavole ed i buffet più raffinati, ma anche per disporre quotidianamente di una cucina super-attrezzata. Il modo più pratico per servire con eleganza e facilità ogni tipo di pietanza dagli spaghetti alla carne, pesce, pane, verdure, formaggi e frutta ma anche piccoli alimenti come dolci, olive e sottaceti. Niente potrà sfuggire inavvertitamente!



**Vegetables serving plier**

Forbice per verdure  
Salad-/Gemüsezange  
Pince à légumes  
Pinza verduras

art.	dim. cm.
12550-81	24



**Serving plier**

Forbice tutto servire  
Servierzange  
Pince à servir  
Pinza servir

art.	dim. cm.
12550-83	21,0
12550-84	26,5
12550-85	24,0



**Pie plier**

Forbice per torta  
Kuchenzange  
Pince à tarte  
Pinza pasteles

art.	dim. cm.
12550-80	28



**Hors-d'oeuvres and pastry plier**

Forbice per antipasti e dolci  
Vorspeisen-/Pâtisseriezange  
Pince à hors-d'oeuvres et pâtisserie  
Pinza entremeses y pasteles

art.	dim. cm.
12550-87	15
12550-89	20



**Pastry plier**

Forbice per dolci  
Gebäckzange  
Pince à pâtisserie  
Pinza pasteles

art.	dim. cm.
12550-88	18



**Grape scissor**

Forbice uva  
Traubenscher  
Ciseaux à rasin  
Tijeras uva

art.	dim. cm.
12550-91	14,5



**Fruit tong**

Molla per frutta  
Fruchtzange  
Pince à fruits  
Pinza frutas

art.	dim. cm.
12550-50	23,5



**Spaghetti-tong**

Molla per spaghetti  
Spaghetizzange  
Pince à spaghetti  
Pinza espagueti

art.	dim. cm.
12550-73	21
12550-74	30



**Toast and pastry tong**

Molla per toast e dolci  
Toast-/Gebäckzange  
Pince à toast et tarte  
Pinza pasteles y tostadas

art.	dim. cm.
12550-77	21
12550-78	24
12550-79	30



**Multipurpose tong**

Molla universale  
Universalzange  
Pince universelle  
Pinza universal

art.	dim. cm.
12550-58	30



**Serving tong**

Molla tutto servire  
Servierzange  
Pince à servir  
Pinza asados y verduras

art.	dim. cm.
12550-68	21
12550-69	26
12550-70	30





**Bread and pastry tong**

Molla per pane e pasticceria  
Brot-/Gebäckzange  
Pince à pain et pâtisserie  
Pinza pan y pasteles

art.	dim. cm.
12550-62	18
12550-63	23
12550-64	26



**Snail tong**

Molla per lumache  
Schneckenzange  
Pince à escargots  
Pinza caracoles

art.	dim. cm.
12550-60	17



**Asparagus tong**

Molla per asparagi  
Spargelzange  
Pince à asperges  
Pinza espárragos

art.	dim. cm.
12550-66	23



**Ice tong**

Molla per ghiaccio  
Eiszange  
Pince à glace  
Pinza hielo

art.	dim. cm.
12550-56	17,5



**Sugar tong**

Molla per zucchero  
Zuckerzange  
Pince à sucre  
Pinza azúcar

art.	dim. cm.
12550-53	12



**Sugar tong**

Molla per zucchero  
Zuckerzange  
Pince à sucre  
Pinza azúcar

art.	dim. cm.
12550-54	12,5



**Ice tong**

Molla per ghiaccio  
Eiszange  
Pince à glace  
Pinza hielo

art.	dim. cm.
12550-55	18,5



**Cake server**

Pala torta  
Tortenheber  
Pelle à gâteau  
Pala tarta

art.	dim. cm.
12550-02	30



**Panettone knife**

Coltello panettone  
Tortenmesser  
Couteau à gâteau  
Cuchillo tarta

art.	dim. cm.
12550-34	32



**Serving fork**

Forchetta a servire  
Serviergabel  
Fourchette à servir  
Tenedor servir

art.	dim. cm.
12550-11	29,5
12550-12	26,0
12550-23	39,0



**Serving spoon**

Cucchiaio a servire  
Servierlöffel  
Cuiller à servir  
Cuchara servir

art.	dim. cm.
12550-13	30,0
12550-14	25,5
12550-22	39,0





**Serving spoon perforated**

Cucchiaio a servire forato  
Servierlöffel, perforiert  
Cuiller à servir perforée  
Cuchara servir, perforada

art.	dim. cm.
12550-24	39,0
12550-25	25,5
12550-26	30,0



**Ladle**

Mestolo  
Schöpfer  
Louche  
Cazo

art.	dim. cm.
12550-01	25,5



**Sauce ladle**

Coppino salsa  
Dressingschöpfer  
Louche à sauce  
Cazillo salsas

art.	dim. cm.
12550-20	16



**Perforated sauce ladle**

Coppino forato  
Dressingschöpfer, gelocht  
Louche à sauce percée  
Cazillo, perforado

art.	dim. cm.
12550-21	16,5



**Spaghetti serving fork**

Forchettone spaghetti  
Spaghettivorlegegabel  
Fourchette à servir spaghetti  
Tenedor servir espagueti

art.	dim. cm.
12550-15	28,5



**Rice ladle**

Cucchiaio risotto  
Reislöffel  
Cuiller à risotto  
Cuchara arroz

art.	dim. cm.
12550-16	28



**Meat fork**

Forchettone  
Tranchiergabel  
Fourchette  
Tenedor

art.	dim. cm.
12550-30	32



**Roast beef knife**

Coltello arrosto  
Tranchiermesser  
Couteau à rôtis  
Cuchillo roastbeef

art.	dim. cm.
12550-33	32



**Butter spreader**

Spatolina burro  
Butterstreicher  
Tarnineur  
Palita mantequilla

art.	dim. cm.	U. Pack
12550-37	16,5	6



**Salt spoon**

Cucchiaino sale  
Salzlöffel  
Cuiller à sel  
Cucharita para sal

art.	dim. cm.	U. Pack
12550-17	6,5	6



**Parmesan spoon**

Cucchiaio parmigiano  
Parmesanlöffel  
Cuiller à parmesan  
Cucharita parmesano

art.	dim. cm.	U. Pack
12550-18	12,5	6





**Ice tea spoon**

Cucchiaio bibita  
Limonadenlöffel  
Cuillère à soda  
Cuchara refresco

art.	dim. cm.	U. Pack
12550-36	19,5	6



**Oyster fork**

Forchettina ostriche  
Austerngabel  
Fourchette à huîtres  
Tenedor ostras

art.	dim. cm.	U. Pack
12550-43	14	6



**Escargot fork**

Forchetta per lumache  
Schneckengabel  
Fourchette à escargots  
Tenedor caracoles

art.	dim. cm.	U. Pack
12550-19	14	6



**Ice tea spoon**

Cucchiaio bibita  
Limonadenlöffel  
Cuillère à soda  
Cuchara refresco

art.	dim. cm.	U. Pack
41605-25	25	6



**Ice spoon**

Cucchiaio ghiaccio  
Eislöffel  
Cuillère à glace  
Cuchara hielo

art.	dim. cm.
12550-04	22



**Dressing spoon**

Cucchiaio salsa  
Saucenlöffel  
Cuillère à sauce  
Cuchara salsa

art.	dim. cm.
12550-06	22



**Monoportion spoon**

Cucchiaio monoporzione  
Monoporzion-Löffel  
Cuillère monoportion  
Cuchara monoporción

art.	dim. cm.	U. Pack
12550-03	9,5	6
12550-07	12,0	6



**Monoportion fork**

Forchetta monoporzione  
Monoporzion-Gabel  
Fourchette monoportion  
Tenedor monoporción

art.	dim. cm.	U. Pack
12550-05	9,5	6



**Monoportion fork**

Forchetta monoporzione  
Monoporzion-Gabel  
Fourchette monoportion  
Tenedor monoporción

art.	dim. cm.	U. Pack
12550-09	12	6



# DISPLAY & PRESENTATION

BUFFET





**Serving stand, chrome plated**

Supporto cromato  
Serviergestell, hartverchromt  
Présentoir, acier chromé  
Soporte platos pastre, acero cromado

art. dim. cm.

44840-01 29x17x41

**For 3 plates cm. 18x18 or 21x21.**  
Per 3 piatti cm. 18x18 oppure 21x21.



**Serving stand, chrome plated**

Supporto cromato  
Serviergestell, hartverchromt  
Présentoir, acier chromé  
Soporte platos pastre, acero cromado

art. dim. cm.

44840-02 33x21x44

**For 3 plates cm. 21x21 or 26,5x26,5.**  
Per 3 piatti cm. 21x21 oppure 26,5x26,5.



**Serving stand, chrome plated**

Supporto cromato  
Serviergestell, hartverchromt  
Présentoir, acier chromé  
Soporte platos pastre, acero cromado

art. dim. cm.

44840-03 37x21x44

**For 3 plates cm. 30x21. – Per 3 piatti cm. 30x21.**



**Serving stand, chrome plated**

Supporto cromato  
Serviergestell, hartverchromt  
Présentoir, acier chromé  
Soporte platos pastre, acero cromado

art. dim. cm.

44840-04 63x27x44,5

**For 2 plates cm. 53x32,5 or 4 plates cm. 53x16,2.**  
Per 2 piatti cm. 53x32,5 oppure 4 piatti cm. 53x16,2.



**Serving stand, chrome plated**

Supporto cromato  
Serviergestell, hartverchromt  
Présentoir, acier chromé  
Soporte platos pastre, acero cromado

art. dim. cm.

44840-05 37,5x37,5x50

**For plates in 3 different sizes: cm. 21x21-26,5x26,5-37x37. – Per piatti di 3 diverse misure: cm. 21x21-26,5x26,5-37x37.**



**Serving stand, chrome plated**

Supporto cromato  
Serviergestell, hartverchromt  
Présentoir, acier chromé  
Soporte, acero cromado

art. Ø cm. h. cm.

44840-27 22 59

**Suitable glasses/Vasetti idonei: 41589C08, 41589C16, 41589-08, 41589-14, 41589-16.**



**Serving stand, chrome plated**

Supporto cromato  
Serviergestell, hartverchromt  
Présentoir, acier chromé  
Soporte, acero cromado

art. Ø cm. h. cm.

44840-28 22 33

**Suitable glasses/Vasetti idonei: 41589C08, 41589C16, 41589-08, 41589-14, 41589-16.**



**Square bowl**

Ciotola quadra  
Schüssel, quadratisch  
Bol carré  
Bol cuadrado

art. dim. cm.

44847B09 9x9x4

44847B13 12,5x12,5x6,5

44847B20 19x19x9



MF

**Square bowl**  
Ciotola quadra  
Schüssel, quadratisch  
Bol carré  
Bol cuadrado

art.	dim. cm.
44847-09	9x9x4
44847-13	12,5x12,5x6,5
44847-20	19x19x9



MF

**Round bowl**  
Ciotola tonda  
Schüssel, rund  
Bol ronde  
Bol redondo

art.	Ø cm.	h. cm.
44846B05	5,5	4,0
44846B09	9,0	4,5
44846B13	13,0	6,5
44846B15	15,0	7,5



MF

**Round bowl**  
Ciotola tonda  
Schüssel, rund  
Bol ronde  
Bol redondo

art.	Ø cm.	h. cm.
44846-05	5,5	4,0
44846-09	9,0	4,5
44846-13	13,0	6,5
44846-15	15,0	7,5



MF

**Party plate**  
Piattino fingerfood  
Fingerfood-Teller  
Petit assiette  
Platillo

art.	dim. cm.	col.
44844-01	9,5x9,5x1,5	○
44844B01	9,5x9,5x1,5	●



MF

**Tray**  
Vassoio  
Tablett  
Plateau  
Bandeja

art.	dim. cm.	GN
44844-11	53x32,5x2,5	1/1



MF

**Tray, square**  
Vassoio quadro  
Tablett, quadratisch  
Plateau carré  
Bandeja, cuadrada

art.	dim. cm.
44841-18	18x18
44841-21	21x21
44841-26	26,5x26,5
44841-37	37x37
44841-51	51x51



MF

**Tray, square**  
Vassoio quadro  
Tablett, quadratisch  
Plateau carré  
Bandeja, cuadrada

art.	dim. cm.
44841B51	51x51





**MF**

**Sushi tray**

Vassoio sushi  
Sushiplatte  
Plateau sushi  
Bandeja sushi

art.	dim. cm.
44842B31	31x10,5
44842B53	53x18



**MF**

**Sushi tray**

Vassoio sushi  
Sushiplatte  
Plateau sushi  
Bandeja sushi

art.	dim. cm.
44842-31	31x10,5
44842-35	35,5x18
44842-30	30x21
44842-53	53x18



GN

**MF**

**Tray**

Vassoio  
Tablett  
Plateau  
Bandeja

art.	dim. cm.	GN
44843-11	53x32,5	1/1
44843-12	32,5x26,5	1/2
44843-24	53x16,2	2/4
44843-13	32,5x17,5	1/3
44843-14	26,5x16,2	1/4



GN

**MF**

**Tray**

Vassoio  
Tablett  
Plateau  
Bandeja

art.	dim. cm.	GN
44843B11	53x32,5	1/1
44843B12	32,5x26,5	1/2
44843B24	53x16,2	2/4
44843B13	32,5x17,5	1/3
44843B14	26,5x16,2	1/4



**MF**

**Round dish**

Piatto tondo  
Platte, rund  
Plat rond  
Bandeja redonda

art.	Ø cm.
44845-51	51
44845-30	30
44845-41	41



**MF**

**Bowl**

Ciotola  
Schale  
Bol  
Bol

art.	Ø cm.	h. cm.	ml.
44466-07	7	6	50



**MF**

**Bowl**

Ciotola  
Schale  
Bol  
Bol

art.	dim. cm.	lt.
44466-11	7,5x7x4,5	0,05



**MF**

**Bowl**

Ciotola  
Schale  
Bol  
Bol

art.	dim. cm.	lt.
44466-12	11,5x7,5x3	0,06



**MF**

**Bowl**

Ciotola  
Schale  
Bol  
Bol

art.	dim. cm.	lt.
44466-13	11,5x6x5,5	0,04



**MF**

**Bowl**

Ciotola  
Schale  
Bol  
Bol

art.	dim. cm.	lt.
44466-14	8,5x7x6	0,07



**MF**

**Bowl**

Ciotola  
Schale  
Bol  
Bol

art.	dim. cm.	lt.
44466-15	8x8x4	0,1



**MF**

**Bowl**

Ciotola  
Schale  
Bol  
Bol

art.	dim. cm.	lt.
44466-16	35x4,5x3	0,2



MF

**Party spoon**

Cucchiaio finger-food  
Finger-food-Löffel  
Cuiller  
Cucharita

art.	dim. cm.	col.
44850-11	11x4,3	○
44850B11	10x4,5	●



MF

**Party spoon**

Cucchiaio finger-food  
Finger-food-Löffel  
Cuiller  
Cucharita

art.	dim. cm.	col.
44850-13	13,5x4,5	○
44850B13	13,5x4,5	●



MF

**Party spoon**

Cucchiaio finger-food  
Finger-food-Löffel  
Cuiller  
Cucharita

art.	dim. cm.	col.
44850-12	10x4,5x1	○
44850B12	10x4,5x1	●
44850G12	10x4,5x1	●



MF

**Party spoon**

Cucchiaio finger-food  
Finger-food-Löffel  
Cuiller  
Cucharita

art.	dim. cm.
44851-01	14,5x4,5



MF

**Party spoon**

Cucchiaio finger-food  
Finger-food-Löffel  
Cuiller  
Cucharita

art.	dim. cm.	col.
44851-02	14,5x4,5	○
44851-03	14,5x4,5	●



MF

**Spoon, set 6 pcs**

Cucchiaio, set 6 pz  
Löffel, 6er Set  
Cuiller, set 6 pcs  
Cuchara, set 6 pz

art.	dim. cm.	col.
44850-00	6x23	○
44850W00	6x23	○
44850B00	6x23	●



PVD

SS

**Party spoon**

Cucchiaio gourmet  
Gourmet-Löffel  
Cuiller gourmet  
Cuchara gourmet

art.	l. cm.	col.
42988-99	13,5	●
42988C99	12,0	●
42988G99	12,0	●



MF

**Bowl oval**

Pirofila ovale  
Schale, oval  
Plat oval  
Fuente ovale

art.	dim. cm.	lt.
44849-27	27x17x4	0,8
44849-34	34x21x4,5	1,3
44849-47	47x29x5	3,2





MF

**Bowl**  
Insalatiera  
Schüssel  
Saladier  
Bol

art.	Ø cm.	h. cm.
44836-30	30	10



MF

**Bowl**  
Insalatiera  
Schüssel  
Saladier  
Bol

art.	dim. cm.
44834-03	40x18,5x10



MF

**Plate**  
Piatto  
Platte  
Plaque  
Plato

art.	dim. cm.
44835-36	36x16x3
44835-45	45x24x3
44835-53	53x29x3,5



MF

**Plate**  
Piatto  
Platte  
Plaque  
Plato

art.	dim. cm.
44834-00	34,5x8x2,5



MF

**Plate**  
Piatto  
Platte  
Plaque  
Plato

art.	dim. cm.
44834-01	40x18,5x3,5
44834-02	52x25x4



MF

**Bowl**  
Insalatiera  
Schüssel  
Saladier  
Bol

art.	dim. cm.
44834G03	40x18,5x10



MF

**Bowl**  
Insalatiera  
Schüssel  
Saladier  
Bol

art.	Ø cm.	h. cm.
44836G30	30	10



MF

**Plate**  
Piatto  
Platte  
Plaque  
Plato

art.	dim. cm.
44835G36	36x16x3
44835G45	45x24x3
44835G53	53x29x3,5



MF

**Plate**  
Piatto  
Platte  
Plaque  
Plato

art.	dim. cm.
44834G00	34,5x8x2,5



MF

**Plate**  
Piatto  
Platte  
Plaque  
Plato

art.	dim. cm.
44834G01	40x18,5x3,5
44834G02	52x25x4



TAO MELAMINE



Mirror shiny inside, outside matt.

Interno lucido, esterno satinato.



**Bowl**  
Ciotola  
Schale  
Bol

art.	dim. cm.	lt.	col.
44449-32	32,5x17,5x10	1,8	○
44449B32	32,5x17,5x10	1,8	●



**Bowl**  
Ciotola  
Schale  
Bol

art.	dim. cm.	lt.	col.
44449-30	30,5x30,5x10	3,3	○
44449B30	30,5x30,5x10	3,3	●



**Bowl**  
Ciotola  
Schale  
Bol

art.	dim. cm.	col.
44446-10	10,5x10x6,5	○
44446-14	13,5x12,5x8,5	○
44446-18	17x16x10,5	○



**Bowl**  
Ciotola  
Schale  
Bol

art.	dim. cm.	col.
44446B10	10,5x10x6,5	●
44446B14	13,5x12,5x8,5	●
44446B18	17x16x10,5	●



**Tray**  
Vassoio  
Tablett  
Plateau  
Bandeja

art.	dim. cm.	col.
44842-31	31x10,5x2	○
44842B31	31x10,5x2	●





Withstands temperatures from -20°C to +70°C.

Termoresistenti da -20°C a +70°C.



**Platter**

Plancia  
Tablett  
Plateau  
Bandeja

art.	dim. cm.	GN
44470-11	53,0x32,5x1	1/1
44470-24	53,0x16,2x1	2/4
44470-12	32,5x26,5x1	1/2
44470-13	32,5x17,5x1	1/3
44470-14	26,5x16,5x1	1/4



**Serving board**

Tagliere  
Servier-Brett  
Planche  
Tabla

art.	Ø cm.	h. cm.
44470-30	30	1
44470-40	40	1



**Bowl**

Ciotola  
Schüssel  
Bol  
Bol Ensalada

art.	dim. cm.	lt.
44470-03	19x19x9	1,5
44470-04	25x25x12	3,8



**Platter**

Plancia  
Tablett  
Plateau  
Bandeja

art.	dim. cm.
44470-73	20x10x2
44470-74	30x10x2
44470-75	30x15x2

GLOBAL MELAMINE



**Bowl**  
Ciotola  
Schale  
Bol  
Bol

art.	dim. cm.
44889-32	32,5x32,5x12
44889-35	35x35x12,5
44889-40	40x40x14



**Bowl**  
Ciotola  
Schale  
Bol  
Bol

art.	Ø cm.	h. cm.
44888-32	32	16,5
44888-35	35	17,0
44888-40	40	17,5



**Bowl**  
Ciotola  
Schale  
Bol  
Bol

art.	dim. cm.	lt.
44882-35	35,5x31,5x14	2,5
44882-46	46x40x18,5	5,5



**Plate**  
Piatto  
Teller  
Assiette  
Plato

art.	Ø cm.	h. cm.
44477-24	11,0	2
44477-25	16,0	2
44477-26	19,5	2
44477-27	24,0	2
44477-28	28,0	2



**Bowl**  
Ciotola  
Schüssel  
Bol  
Bol

art.	Ø cm.	h. cm.	lt.
44477-40	7,5	3,0	0,04
44477-41	7,5	6,5	0,13
44477-44	23,0	3,0	0,40

Picture/Foto: 44477-24 + 44477-41.



**Bowl**  
Ciotola  
Schüssel  
Bol  
Bol

art.	dim. cm.	lt.
44477-52	7,5x7,5x3	0,05
44477-53	7,5x7,5x6,5	0,16
44477-54	15,5x15,5x3	0,19
44477-55	15,5x15,5x6,5	0,85



**Bowl**  
Ciotola  
Schüssel  
Bol  
Bol

art.	dim. cm.	lt.
44477-64	15,5x7,5x3	0,10
44477-65	15,5x7,5x6,5	0,40
44477-66	15,5x9,5x3	0,15
44477-67	15,5x9,5x6,5	0,50
44477-68	25x15,5x3	0,30
44477-69	25x15,5x6,5	1,40





**Tray**  
Vassoio  
Tablett  
Plateau  
Bandeja

art.	dim. cm.	GN
44477-76	53x32,5x3	1/1
44477-77	32,5x26,5x3	1/2
44477-78	32,5x17,6x3	1/3
44477-79	26,5x16,2x3	1/4
44477-80	35,4x32,5x3	2/3
44477-81	53x16,2x3	2/4

**Picture/Foto: 44477-52, -53, -66, -77.**



**Bowl**  
Ciotola  
Schüssel  
Bol

art.	Ø cm.	h. cm.	lt.
41446-18	18	9,5	1,0
41446-23	23	12,5	2,2

**Concrete. – Cemento.**



**Bowl**  
Ciotola  
Schüssel  
Bol

art.	Ø cm.	h. cm.	lt.
41445-22	22,0	10,5	1,1
41445-26	26,0	13,0	1,7
41445-30	29,5	14,5	2,5

**Concrete. – Cemento.**

**BUFFET  
DISPLAY & PRESENTATION**



**Stand chromed**  
Alzata cromata  
Ständer, verchromt  
Support chromé  
Soporte cromado

art.	dim. cm.
44840-50	53x32,5-53x16,5
44840-51	32,5x26,5-26,5x16,2
44840-52	32,5x17,5-35,4x32,5

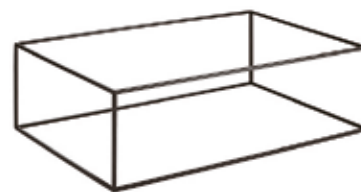

**Stand**  
Alzata  
Ständer  
Support  
Soporte

art.	dim. cm.
44840-55	53x32,5-53x16,5
44840-56	32,5x26,5-26,5x16,2
44840-57	32,5x17,5-35,4x32,5

**Black coating. – Rivestimento nero.**



**Stand chromed**  
Alzata cromata  
Ständer, verchromt  
Support chromé  
Soporte cromado

art.	Ø cm.	h. cm.
44478-77	38,0	16,5
44478-79	48,5	16,5



**Stand chromed**  
Alzata cromata  
Ständer, verchromt  
Support chromé  
Soporte cromado

art.	Ø cm.	h. cm.
44478-78	38,0	27
44478-80	48,5	27



**Tray**  
Vassoio  
Tablett  
Plateau  
Bandeja

art.	Ø cm.	h. cm.
44478-70	30,0	3
44478-71	38,0	3
44478-72	48,5	3





**W**

**Tray**

Vassoio  
Tablett  
Plateau  
Bandeja

art.	Ø cm.	h. cm.
44478-73	38,0	2,5
44478-74	48,5	2,5



**W**

**Intermediate tray**

Vassoio intermedio  
Zwischenplatte  
Plateau intermédiaire  
Bandeja intermedia

art.	Ø cm.	h. cm.
44478-75	38,0	2,5
44478-76	48,5	2,5



**FE**

**Stand**

Alzata  
Ständer  
Support  
Soporte

art.	h. cm.
44840-30	8
44840-31	12
44840-32	18

**Black anti-slide coating.**  
Rivestimento antiscivolo nero.



**FE**

**Stand**

Alzata  
Ständer  
Support  
Soporte

art.	Ø cm.	h. cm.
44840-40	15,5-18	8
44840-41	15,5-18	10
44840-42	15,5-18	18

**Black anti-slide coating.**  
Rivestimento antiscivolo nero.

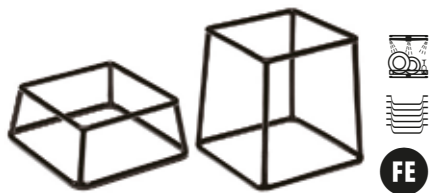

FE

**Stand**

Alzata  
Ständer  
Support  
Soporte

art.	dim. cm.
44840-08	18x18x8
44840-10	18x18x10
44840-18	18x18x18

**Black anti-slide coating.**  
Rivestimento antiscivolo nero.



FE

**Basket**

Cesto  
Korb  
Panier  
Cesta

art.	Ø cm.	h. cm.
44476-20	21-16,5	21



SS

**Stand/basket**

Alzata/cesto  
Ständer/Korb  
Support/panier  
Soporte/cesta

art.	Ø cm.	h. cm.
44476-26	21	10,5
44476-28	21	20,0



SS

**Stand/basket**

Alzata/cesto  
Ständer/Korb  
Support/panier  
Soporte/cesta

art.	Ø cm.	h. cm.	col.
44476-27	21	10,5	●
44476-29	21	20,0	●



FE

**Stand/basket**

Alzata/cesto  
Ständer/Korb  
Support/panier  
Soporte/cesta

art.	Ø cm.	h. cm.	col.
44476-51	10,5-8	8	●



FE

**Stand/basket**

Alzata/cesto  
Ständer/Korb  
Support/panier  
Soporte/cesta

art.	Ø cm.	h. cm.	col.
44476-52	10,5-8	8	●



FE

**Stand/basket**

Alzata/cesto  
Ständer/Korb  
Support/panier  
Soporte/cesta

art.	Ø cm.	h. cm.	col.
44476-53	10,5-8	8	●



FE

**Stand/basket chromed**

Alzata/cesto cromato  
Ständer/Korb, verchromt  
Support/panier, chromé  
Soporte/cesta cromado

art.	Ø cm.	h. cm.
44476-30	15	10,5
44476-31	21	20,0



FE

**Stand/basket**

Alzata/cesto  
Ständer/Korb  
Support/panier  
Soporte/cesta

art.	Ø cm.	h. cm.	col.
44476-32	15	10,5	●
44476-33	21	20,0	●



PMMA

**Buffet display, 3 pcs set**

Display per buffet, set 3 pz  
Büffetgestell, 3er Set  
Étagère à buffet, set 3 pcs  
Expositor para buffet, set 3 pz

art.	dim. cm.
41919-03	40x18x4
41919-03	40x20x8
41919-03	40x22x12



**Buffet display**

Display per buffet  
Büffetgestell  
Etagère à buffet  
Expositor para buffet

art. dim. cm.  
41870-01 54x47x63

**Shelves/Ripiani: 47x34 - 37x25 - 27x17 - 23x13 cm.**



**Buffet display**

Display per buffet  
Büffetgestell  
Etagère à buffet  
Expositor para buffet

art. Ø cm. h. cm.  
41870-03 28 29

**Shelves/Ripiani: 38x30x21 - 38x30x13 - 38x30x5 cm.**



**Buffet display**

Display per buffet  
Büffetgestell  
Etagère à buffet  
Expositor para buffet

art. dim. cm.  
41870-02 40x40x53

**Shelves/Ripiani: 40x40 - 30x30 - 22x22 - 27x17 - 23x13 cm.**



**Buffet display**

Display per buffet  
Büffetgestell  
Etagère à buffet  
Expositor para buffet

art. dim. cm.  
41870-04 40x27x29

**Shelves/Ripiani: 40x27x21 - 40x27x13 - 40x27x5 cm.**





SS

**Fruit stand, 3 tiers**

Alzata frutta, 3 piani  
Obstständer, 3-stöckig  
Etagère à fruits, 3 étages  
Frutero 3 pisos

art.	Ø cm.	h. cm.
42940-03	32-38-48	50



**Wedding cake stand, aluminum**

Alzata per torte, alluminio  
Hochzeitstortenständer, Aluminium  
Support pour tourte de mariage, alu  
Pedestal para tartas, aluminio

art.	Ø cm.
47100-03	20-26-32
47100-04	20-26-32-40
47100-05	20-26-32-40-45

**Distance between tiers 16,5 cm.**  
Distanziali h. 16,5 cm.



**Wedding cake stand, aluminum**

Alzata per torte, alluminio  
Hochzeitstortenständer, Aluminium  
Support pour tourte de mariage, alu  
Pedestal para tartas, aluminio

art.	Ø cm.
47100-06	20-26-32-40-45-50
47100-07	16-20-26-32-40-45-50
47100-08	16-20-26-32-40-45-50-55

**Distance between tiers 16,5 cm.**  
Distanziali h. 16,5 cm.



SS

**Lightning column**

Colonna luminosa  
Lichtsäule  
Socle lumineux  
Columna luminosa

art.	Ø cm.	h. cm.
42979-00	30	21

**Stainless steel base plate ø30 cm., PMMA column, LED-light box and remote control.**  
Base inox ø cm 30, colonna PMMA, scatola luci-LED con telecomando.



SS

**Oyster plate**

Piatto frutti di mare  
Austernplatte  
Plat à huîtres  
Fuente de mariscos

art.	Ø cm.	h. cm.
42979-36	36	4,5

**The plate has a centering element which keeps it anchored to the column.**



SS

**Oyster plate**

Piatto frutti di mare  
Austernplatte  
Plat à huîtres  
Fuente de mariscos

art.	Ø cm.	h. cm.
42979-45	45	5,5

**Sotto il piatto è fissato un elemento di centraggio che lo mantiene ancorato alla colonna luminosa.**



NEW

SS

**Chocolate fountain**

Fontana cioccolato  
Schokoladenbrunnen  
Fontaine à chocolat  
Fuente para chocolate

art.	Ø cm.	h. cm.	lt.	W
42982-08	38	80	3,5	370

**230V-50Hz-Amps 1,6A. Minimum quantity of chocolate necessary for operation is about 3.5 kg, the maximum is 8 kg. –** Quantità minima di cioccolata richiesta per funzionare è di circa 3,5 kg e può contenerne fino a 8 kg.



SS

**Cocktail fountain**

Fontana cocktails  
Cocktails-Laufbrunnen  
Fontaine à cocktails  
Fuente cocktail

art.	Ø cm.	h. cm.	lt.
42981-73	42	56	15

**10W 220V. NOT recommend for use with fizzy drinks or champagne. –** Prodotto NON consigliato per liquidi gasati o champagne.





**Champagne Waterfall**

Cascata champagne  
Sekt Wasserfall  
Cascade à champagne  
Cascada champañá

art.	Ø cm.	h. cm.
42980-01	45	64

**LED lighting multicolor cycle. For 42 champagne cups.** – Illuminazione led a ciclo multicolore. Per 42 coppe champagne.



**Champagne Waterfall**

Cascata champagne  
Sekt Wasserfall  
Cascade à champagne  
Cascada champañá

art.	Ø cm.	h. cm.
42980-02	45	107

**LED lighting multicolor cycle. For 73 champagne cups.** – Illuminazione led a ciclo multicolore. Per 73 coppe champagne.



**Punch bowl**

Coppa punch  
Punchbowle  
Rafraîchisseur  
Ponchero

art.	Ø cm.	lt.
41541-44	44	15

**Stainless steel bottom ring.** – Piede inox.



**Punch bowl**

Coppa punch  
Punchbowle  
Rafraîchisseur  
Ponchero

art.	Ø cm.	lt.
11956-37	36	9,5
11956-42	42	15,0



**Big party tub**

Secchio portabottiglie  
Flaschenkühler-Bowle  
Rafraîchisseur à bouteilles  
Ponchero

art.	dim. cm.
44946-04	40x28x23



**Big party tub**

Secchio portabottiglie  
Flaschenkühler-Bowle  
Rafraîchisseur à bouteilles  
Ponchero

art.	dim. cm.
44946B05	35x35x20



ACRYLIC MIRRORS  
SPECCHI ACRILICI PMMA



**Mirror, square**  
Specchio quadrato  
Spiegel, quadratisch  
Miroir carré  
Espejo cuadrado

art.	dim. cm.
41885-30	30x30
41885-40	40x40
41885-45	45x45
41885-50	50x50
41885-60	60x60



**Mirror, oval**  
Specchio ovale  
Spiegel, oval  
Miroir ovale  
Espejo oval

art.	dim. cm.
41877-45	45x30
41877-61	61x45,5
41877-81	81x61
41877-99	100x70



**Mirror, rectangular**  
Specchio rettangolare  
Spiegel, rechteckig  
Miroir rectangulaire  
Espejo rectangular

art.	dim. cm.
41878-45	45x30
41878-61	61x46
41878-81	81x58,5
41878-99	100x70





**Mirror, octagon**  
Specchio ottagonale  
Spiegel, achteckig  
Miroir octogonal  
Espejo octogonal

art.	Ø cm.
41879-30	30
41879-40	40
41879-50	50
41879-61	61



**Mirror, hexagon**  
Specchio esagono  
Spiegel, Sechseck  
Miroir hexagon  
Espejo hexágono

art.	Ø cm.
41880-38	38
41880-61	61



**Mirror, comma**  
Specchio virgola  
Spiegel, Komma  
Miroir virgule  
Espejo vírgula

art.	Ø cm.
41875-40	40,6
41875-61	61,0



**Mirror, segment**  
Specchio spicchio  
Spiegel, Segment  
Miroir quartier  
Espejo segmento

art.	Ø cm.
41881-30	30,5
41881-40	40,5



**Mirror, circle**  
Specchio cerchio  
Spiegel, Kreis  
Miroir cercle  
Espejo aro

art.	Ø cm.
41876-30	30,5
41876-38	38,0
41876-45	45,0
41876-58	58,0



**Mirror, cube**  
Specchio cubo  
Spiegel, Würfel  
Miroir cube  
Espejo cubo

art.	dim. cm.
41882-15	15x15x15
41882-20	20x20x20
41882-25	25x25x25
41882-30	30x30x30



**W**  
**FE**

**Set 2 lanterns**  
Set 2 lanternne  
Set 2 laternen  
Set 2 lanternes  
Set 2 linternas

art.	dim. cm.
42440-30	22x20x52 30x26x71



**W**  
**FE**

**Set 2 lanterns**  
Set 2 lanternne  
Set 2 laternen  
Set 2 lanternes  
Set 2 linternas

art.	dim. cm.
42441-25	17x17x44 25x25x62



**W**  
**FE**

**Set 2 lanterns**  
Set 2 lanternne  
Set 2 laternen  
Set 2 lanternes  
Set 2 linternas

art.	dim. cm.
42442-24	17x17x45 24x24x67



**Set 3 candele**

Set 3 candles  
Kunstkerzen, 3er Set  
Set 3 bougies  
Set 3 velas

art.	Ø cm.	h. cm.
42445-03	9	12,5
	9	18
	9	23

**Resin. Timer function 5 hours ON/19 OFF. Powered by 2D alkaline batteries (not incl.). Working time >800 hours. Flameless moving wick. – Resina. Funzione timer 5 ore ON/19 OFF. 2 batterie alcaline D (non incluse). Durata > 800 ore. Stoppino mobile senza fiamma.**



**Tray stand, chromed**

Stand per vassoi, cromato  
Tablett-Träger, verchromt  
Porte plateaux, chromé  
Soporte para bandejas, cromado

art.	dim. cm.
44093-00	38x 48x74



**Tray stand**

Stand per vassoi  
Tablett-Träger  
Porte plateaux  
Soporte para bandejas

art.	dim. cm.
44093-01	42x43x82



**Tray**

Vassoio  
Tablett  
Plateau  
Bandeja

art.	dim. cm.	GN
41430-11	53x32,5x5	1/1

**Chrome plated handles. Useful height 4 cm. Maniglie cromate. Altezza utile 4 cm.**



**Tray**

Vassoio  
Tablett  
Plateau  
Bandeja

art.	dim. cm.	GN
41436-11	53x32,5	1/1
41436-12	32,5x26,5	1/2



**Tray, deko-edge**

Vassoio bordo Deko  
Tablett, Dekorrand  
Plateau avec décor  
Bandeja, borde decorado

art.	dim. cm.	GN
41437-11	53x32,5	1/1
41437-12	32,5x26,5	1/2



**Tray, deko-edge**

Vassoio bordo Deko  
Tablett, Dekorrand  
Plateau avec décor  
Bandeja, borde decorado

art.	Ø mm.
41439-32	32
41439-38	38
41439-48	48





SS

**Tray, deko-edge**

Vassoio bordo Deko  
Tablett, Dekorrand  
Plateau avec décor  
Bandeja, borde decorado

art.	dim. cm.
41438-50	50x36
41438-60	60x41
41438-70	70x46



SS

**Fish tray**

Vassoio pesce  
Fischplatte  
Plat à poisson  
Salmonera

art.	dim. cm.
66345-55	55x23
66345-65	65x27
66345-74	74x29



SS

**Fish tray**

Vassoio pesce  
Fischplatte  
Plat à poisson  
Salmonera

art.	dim. cm.
41654-80	80x31
41654-99	100x35



SS

**Tray, oval**

Vassoio ovale  
Tablett, oval  
Plateau ovale  
Bandeja oval

art.	dim. cm.
41651-20	20x14
41651-25	25x18
41651-30	30x22
41651-35	35x22
41651-40	40x26



SS

**Tray, oval**

Vassoio ovale  
Tablett, oval  
Plateau ovale  
Bandeja oval

art.	dim. cm.
41651-45	45x29
41651-50	50x35
41651-55	55x38
41651-60	60x42
41651-65	65x45



SS

**Tray, round**

Vassoio tondo  
Tablett, rund  
Plateau rond  
Bandeja redonda

art.	Ø cm.
66326-30	30
66326-35	35
66326-40	40
66326-60	60
66326-80	80



SS

**Tray, oval**

Vassoio ovale  
Tablett, oval  
Plateau ovale  
Bandeja oval

art.	dim. cm.
66325-30	30x19
66325-35	35x22
66325-41	41x26
66325-46	46x29
66325-54	54x37
66325-85	85x58
66325-99	100x68



SS

**Tray, rectangular**

Vassoio rettangolare  
Serviertablett, rechteckig  
Plateau rectangulaire  
Bandeja rectangular

art.	dim. cm.
66320-28	28x20
66320-35	35x30
66320-40	40x26
66320-50	50x38
66320-65	65x50
66320-85	85x50
66320-99	100x50



SS

**Tray, rectangular**

Vassoio rettangolare  
Serviertablett, rechteckig  
Plateau rectangulaire  
Bandeja rectangular

art.	dim. cm.
66324-40	40x26
66324-50	50x38
66324-65	65x50
66324-85	85x50
66324-99	100x50

BUFFET SYSTEM



**ACACIA WOOD** for a multifunctional buffet system that adapts in height and width to all space requirements. The stackable and non-slip reversible boxes can be used individually or connected with flat GN trays.

**LEGNO DI ACACIA** per un sistema multifunzionale che si adatta in altezza e larghezza a tutte le esigenze di spazio. Le scatole reversibili e antiscivolo possono essere utilizzate singolarmente o collegate con i piani GN.



**Box**  
Scatola  
Wendebox  
Boîte  
Caja

art.	dim. cm.	GN
42463A02	55,5x35x10,5	1/1



**Box**  
Scatola  
Wendebox  
Boîte  
Caja

art.	dim. cm.	GN
42463A04	55,5x18,5x10,5	2/4



**Box**  
Scatola  
Wendebox  
Boîte  
Caja

art.	dim. cm.	GN
42463A05	35x29x10,5	1/2



**Box**  
Scatola  
Wendebox  
Boîte  
Caja

art.	dim. cm.	GN
42463A08	29x18,5x10,5	1/4



**Box**  
Scatola  
Wendebox  
Boîte  
Caja

art.	dim. cm.	GN
42463B02	55,5x35x10,5	1/1



**Box**  
Scatola  
Wendebox  
Boîte  
Caja

art.	dim. cm.	GN
42463B04	55,5x18,5x10,5	2/4





**Box**  
Scatola  
Wendebox  
Boîte  
Caja

art. dim. cm. GN  
42463B05 35x29x10,5 1/2



**Box**  
Scatola  
Wendebox  
Boîte  
Caja

art. dim. cm. GN  
42463B08 29x18,5x10,5 1/4



**Bread box**  
Cesta pane  
Brotkiste  
Caisse à pain  
Cajón para pan

art. dim. cm.  
42874-01 34x26x12,5  
42874-02 34x26x20

**Beech wood. – Faggio.**



**Bread cutting board**  
Tagliere  
Brotschneidbrett  
Planche à découper  
Tabla de corte

art. dim. cm.  
42874-03 52x34x2

**Beech wood. – Faggio.**



**Cutting board tray**  
Vassoio per tagliere  
Schneidbrett-Tablett  
Plateau pour planche à découper  
Bandeja para tabla de corte

art. dim. cm.  
42874-04 60x35,5x3,5



**Pretzel stand**  
Porta Brezel  
Brezel- oder Wurstständer  
Support à brezel  
Soporte para brezel

art. Ø cm. h. cm.  
42870-50 22 50

**Beechwood. – Faggio.**



**Hygienic cover**  
Copertura igienica  
Hygieneschutz  
Couverture d'hygiène  
Cobertura d'igiene

art. dim. cm.  
42870-51 20x20x50





AY  
SS

**Bread roll-dispenser**  
Distributore panini  
Brötchen-Spender  
Distributeur à pain  
Dispensador de pan

art. dim. cm.  
42963-55 32x22x55

For/Per: 65-70 pcs.



W

**Bread slicer**  
Taglia pane  
Brottschneidergerät  
Coupe-pain  
Corta-pan

art. dim. cm.  
49833-00 41x15x10



AY

**Hygienic cover**  
Copertura igienica  
Hygieneschutz  
Couverture d'hygiène  
Cobertura d'higiene

art. dim. cm.  
42873-65 65x39x42

Chrome plated wire stand. – Supporto cromato.



PP

**Bread basket**

Cesto pane  
Brotkorb  
Corbeille à pain  
Cesta pan

art.	dim. cm.	GN	col.
42462-11	53x32,5x6,5	1/1	●
42462-12	32,5x26,5x6,5	1/2	●
42462-13	32,5x17,5x6,5	1/3	●
42462-14	26,4x16,2x6,5	1/4	●
42462-16	17,6x16,2x6,5	1/6	●
42462-23	32,5x35,4x6,5	2/3	●



PP

**Bread basket**

Cesto pane  
Brotkorb  
Corbeille à pain  
Cesta pan

art.	dim. cm.	GN	col.
42463-11	53x32,5x10	1/1	●
42463-12	32,5x26,5x10	1/2	●
42463-13	32,5x17,5x10	1/3	●
42463-14	26,4x16,2x10	1/4	●
42463-16	17,6x16,2x10	1/6	●
42463-23	32,5x35,4x10	2/3	●



PP

**Bread basket**

Cesto pane  
Brotkorb  
Corbeille à pain  
Cesta pan

art.	dim. cm.	GN	col.
42967-63	53x32,5x6,5	1/1	●
42967-64	32,5x26,5x6,5	1/2	●
42967-65	32,5x17,5x6,5	1/3	●
42967-66	26,4x16,2x6,5	1/4	●
42967-67	17,6x16,2x6,5	1/6	●
42967-68	32,5x35,4x6,5	2/3	●



PP

**Bread basket**

Cesto pane  
Brotkorb  
Corbeille à pain  
Cesta pan

art.	dim. cm.	GN	col.
42967-73	53x32,5x10	1/1	●
42967-74	32,5x26,5x10	1/2	●
42967-75	32,5x17,5x10	1/3	●
42967-76	26,4x16,2x10	1/4	●
42967-77	17,6x16,2x10	1/6	●
42967-78	32,5x35,4x10	2/3	●



**BUFFET**



**Bread basket**

Cesto pane  
Brotkorb  
Corbeille à pain  
Cesta pan

art.	dim. cm.	GN	col.
42967-03	53x32,5x6,5	1/1	●
42967-04	32,5x26,5x6,5	1/2	●
42967-05	32,5x17,5x6,5	1/3	●
42967-06	26,4x16,2x6,5	1/4	●
42967-07	17,6x16,2x6,5	1/6	●
42967-08	32,5x35,4x6,5	2/3	●



**Bread basket**

Cesto pane  
Brotkorb  
Corbeille à pain  
Cesta pan

art.	dim. cm.	GN	col.
42967-13	53x32,5x10	1/1	●
42967-14	32,5x26,5x10	1/2	●
42967-15	32,5x17,5x10	1/3	●
42967-16	26,4x16,2x10	1/4	●
42967-17	17,6x16,2x10	1/6	●
42967-18	32,5x35,4x10	2/3	●



**Bread basket**

Cesto pane  
Brot-Korb  
Corbeille à pain  
Cesta pan

art.	dim. cm.	l. cm.
42973-30	30x40	16/27



**Bread basket**

Cesto pane  
Brot-Korb  
Corbeille à pain  
Cesta pan

art.	dim. cm.	l. cm.
42973-45	45x40	16/27
42973-61		



**Bread basket**

Cesto pane  
Brot-Korb  
Corbeille à pain  
Cesta pan

art.	dim. cm.	l. cm.
42973-60	60x40	16/27



**Bread basket**

Cesta baguettes  
Brotkorb  
Corbeille à pain  
Cesta pan

art.	cap. kg.	l. cm.
42967-35	35	25/42



**Bread basket**

Cesta baguettes  
Brotkorb  
Corbeille à pain  
Cesta pan

art.	cap. kg.	l. cm.
42972-28	30	38



**Bread basket**

Cesto pane  
Brotkorb  
Corbeille à pain  
Cesta pan

art.	cap. kg.	l. cm.
42968-38	38	10



**Bread basket**

Cesto pane  
Brotkorb  
Corbeille à pain  
Cesta pan

art.	cap. kg.	l. cm.
42968-42	42	12



**Bread basket**

Cesto pane  
Brotkorb  
Corbeille à pain  
Cesta pan

art.	cap. kg.	l. cm.
42969-31	31/37	6/12



**Bread basket**

Cesto pane  
Brotkorb  
Corbeille à pain  
Cesta pan

art.	cap. kg.	l. cm.
42969-36	36,5	12



**Bread basket**

Cesto pane  
Brotkorb  
Corbeille à pain  
Cesta pan

art.	dim. cm.	h. cm.
42967-43	45x42	17/24



**Bread basket**

Cesto pane  
Brotkorb  
Corbeille à pain  
Cesta pan

art.	dim. cm.
42972-01	40x20x5
42972-02	40x30x5
42972-03	60x20x5
42972-04	60x40x5



**Bread basket**

Cesto pane  
Brotkorb  
Corbeille à pain  
Cesta pan

art.	dim. cm.
42967-53	53x32,5x15,5



**Bread basket**

Cesto pane  
Brotkorb  
Corbeille à pain  
Cesta pan

art.	dim. cm.
42936-23	23x19x9



**Bread basket**

Cesto pane  
Brotkorb  
Corbeille à pain  
Cesta pan

art.	dim. cm.
42936-24	24x17x8
42936-28	28x16x8,5



**Bread basket**

Cesto pane  
Brotkorb  
Corbeille à pain  
Cesta pan

art.	dim. cm.
42946-23	23x10x6
42946-37	37,5x15x7



**Bread basket**

Cesto pane  
Brotkorb  
Corbeille à pain  
Cesta pan

art.	dim. cm.
42947-23	23x15x7
42947-30	30x22x7
42947-40	41x29x7



**Bread basket**

Cesto pane  
Brotkorb  
Corbeille à pain  
Cesta pan

art.	dim. cm.	GN
42969-11	53,5x32,5x9,5	1/1



**Bread basket**

Cesto pane  
Brotkorb  
Corbeille à pain  
Cesta pan

art.	dim. cm.	GN
42965-12	32,5x26,5x8	1/2





**Bread basket**

Cesto pane  
Brotkorb  
Corbeille à pain  
Cesta pan

art. dim. cm. GN  
42967-11 56,5x36x10 1/1

**With frame to fix the cover.**  
Con telaio per fissare il coperchio.



**Roll-top cover**

Coperchio roll-top  
Rolltophaube  
Couvercle roll-top  
Tapa roll-top

art. dim. cm. GN  
41415-11 53x32,5x17 1/1

**Chrome knob. – Pomolo cromato.**



**Bread basket**

Cesto pane  
Brotkorb  
Corbeille à pain  
Cesta pan

art. dim. cm. GN  
42461-11 56,5x36x10 1/1

**With frame to fix the cover.**  
Con telaio per fissare il coperchio.



**Roll-top cover**

Coperchio roll-top  
Rolltophaube  
Couvercle roll-top  
Tapa roll-top

art. dim. cm. GN  
42452-53 53x32,5x17 1/1

**Chrome knob. – Pomolo cromato.**



**Bread basket**

Cesto pane  
Brotkorb  
Corbeille à pain  
Cesta pan

art. cap. kg. l. cm.  
42461-35 35 20

**With frame to fix the cover.**  
Con telaio per fissare il coperchio.



**Roll-top cover**

Coperchio roll-top  
Rolltophaube  
Couvercle roll-top  
Campana roll-top

art. cap. kg.  
42452-35 35



**Cover**

Coperchio  
Kuppelhaube  
Couvercle  
Campana

art. dim. cm. GN  
41419-12 33x28x17 1/2

**One front cut. – Con apertura frontale.**



**Cover**

Coperchio  
Kuppelhaube  
Couvercle  
Campana

art. dim. cm. GN  
41418-11 54x33x20 1/1

**One front cut. – Con apertura frontale.**



**Cover**

Coperchio  
Kuppelhaube  
Couvercle  
Campana

art. dim. cm. GN  
41418-12 54x33x20 1/1

**Totally closed. – Chiuso.**



**Bread basket**

Cesto pane  
Brotkorb  
Corbeille à pain  
Cesta pan

art. dim. cm. col.  
42991-25 25x19X6,5 ●  
42991-32 32x23X7 ●



**Bread basket**

Cesto pane  
Brotkorb  
Corbeille à pain  
Cesta pan

art. dim. cm. col.  
42991M25 25x19X6,5 ●  
42991M32 32x23X7 ●



**Bread basket**

Cesto pane  
Brotkorb  
Corbeille à pain  
Cesta pan

art. dim. cm. col.  
42991N25 25x19X6,5 ●  
42991N32 32x23X7 ●



**Bread basket**

Cesto pane  
Brotkorb  
Corbeille à pain  
Cesta pan

art.	dim. cm.	col.
42993-40	40X30X10	●
42993M40	40X30X10	●
42993N40	40X30X10	●



**Bread basket**

Cesto pane  
Brotkorb  
Corbeille à pain  
Cesta pan

art.	cap. kg.	l. cm.	col.
42990-16	16	8	●
42990-20	20	8	●
42990-29	29	7	●



**Bread basket**

Cesto pane  
Brotkorb  
Corbeille à pain  
Cesta pan

art.	cap. kg.	l. cm.	col.
42990M16	16	8	●
42990M20	20	8	●
42990M29	29	7	●



**Bread basket**

Cesto pane  
Brotkorb  
Corbeille à pain  
Cesta pan

art.	cap. kg.	l. cm.	col.
42990N16	16	8	●
42990N20	20	8	●
42990N29	29	7	●



**Bread basket stand**

Alzata ceste  
Körbe-Gestell  
Etagère à corbeilles  
Soporte ceste pan

art.	dim. cm.
42870-59	30,5x59x58

**For baskets 42968-38 and 42967-13.**  
Per cesti 42968-38 e 42967-13.



**Wire stand chrome plated, 2 tiers**

Supporto filo cromato, 2 piani  
Brotkorb-Drahtgestell, Doppeldecker  
Support en fil chromé, 2 étages  
Estructura alambre cromado, 2 alturas

art.	dim. cm.	GN
42872-02	46x24x21	1/2

**For baskets/Per cesti:**  
**42965-12, 42967- 04-14-64-74.**

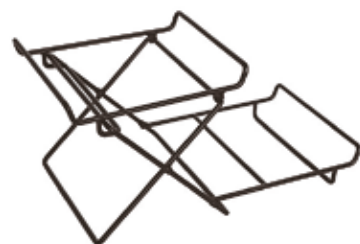

**Wire stand black, 2 tiers**

Supporto filo nero, 2 piani  
Brotkorb-Drahtgestell, Doppeldecker  
Support en fil noir, 2 étages  
Estructura alambre negro, 2 alturas

art.	dim. cm.	GN
41220-06	44,5x26x22	1/2



**Basket with black wire stand**

Cesto con supporto filo nero  
Korbdrahtgestell, schwarz  
Panier support en fil noir  
Cesta estructura alambre negro

art.	dim. cm.
41220-02	40x30
41220-03	60x40

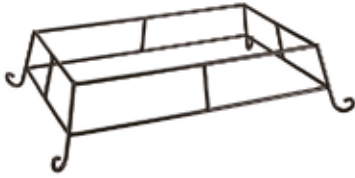

**NEW**

**Wire stand black**

Supporto filo nero  
Drahtgestell, schwarz  
Support en fil noir  
Estructura alambre negro

art.	dim. cm.	GN
41220-07	49,5x30x13,5	1/1



**NEW**

**PP**

**Basket with black wire stand**

Cesto con supporto filo nero  
Korbdrahtgestell, schwarz  
Panier support en fil noir  
Cesta estructura alambre negro

art.	Ø cm.	h. cm.
41220-01	38	15,5



**NEW**

**PP**

**Basket with black wire stand**

Cesto con supporto filo nero  
Korbdrahtgestell, schwarz  
Panier support en fil noir  
Cesta estructura alambre negro

art.	Ø cm.	h. cm.
41220-04	33	15,5



**NEW**

**PP**

**Basket with black wire stand**

Cesto con supporto filo nero  
Korbdrahtgestell, schwarz  
Panier support en fil noir  
Cesta estructura alambre negro

art.	Ø cm.	h. cm.
41220-05	43	15,5



**Round canvas bag**

Cesto cotone, rotondo  
Brottasche, rund, Baumwolle  
Panier à pain, coton  
Cesta pan, algodón

art.	cap. kg.	l. cm.	col.
42873-02	20	23,5	●

**Stone pillow included. Easy to heat up in microwave for 90 sec. at 500 Watt. Machine washable up to 30°C (except pillow).** – Cuscino noccioli di ceramica incluso. Scaldare in microonde per 90 secondi a 500 Watt. Lavabile in lavatrice max 30°C (escluso cuscino).



**R**

**Egg basket, keeps warm**

Cesto uova, imbottito  
Eier-Korb, hält warm  
Panier à oeufs, fourré  
Cesta para huevos

art.	cap. kg.	l. cm.
42949-26	26	17

**For around 20 eggs. – Per c.ca 20 uova.**



**Sign holders, chromed**

Clip flessibili, cromate  
Schildhalter, verchromt  
Porte-étiquettes, chromés  
Porta etiquetas con clip, cromate

art.	l. cm.	pcs/pz
41394-02	12	2



**Chalkmarker**

Penna a gesso liquido  
Kreidestifte  
Stylo à craie liquide  
Rotulador de tiza líquida

art.	Ø mm.	col.
47832-00	5	○
47832-01	5	●
47832-02	5	●
47832-03	5	●
47832-04	5	●
47832-05	5	●

**Clean with water. Writes on all non porous surfaces. – Pulire con acqua. Scrive su tutte le superfici non porose.**



**Chalkmarker**

Penna a gesso liquido  
Kreidestifte

Stylo à craie liquide

Rotulador de tiza líquida

art.	Ø mm.	col.
47832-10	15	○
47832-11	15	●
47832-12	15	●
47832-13	15	●
47832-14	15	●
47832-15	15	●



W  
SAN  
SS

**Showplate, 3-pcs set**

Vetrina, set 3 pezzi

Buffetvitrine, 3-teilig

Etagère, set 3 pièces

Vitrina, 3 elementos

art.	Ø cm.	h. cm.
41429-04	45	24



SAN

**Roll-top cover**

Coperchio roll-top

Rolltophaube

Couvercle roll-top

Campana roll-top

art.	Ø cm.	h. cm.
41447-38	38	20

Chrome knob. – Pomolo cromato.



SAN  
SS

**Showplate, 2-pcs set**

Vetrina, set 2 pezzi

Buffetvitrine, 2-teilig

Etagère, set 2 pièces

Vitrina, 2 elementos

art.	Ø cm.	h. cm.
41447-02	38	21



W  
SAN  
SS

**Showplate, 5-pcs set**

Vetrina, set 5 pezzi

Buffetvitrine, 5-teilig

Etagère, set 5 pièces

Vitrina, 5 elementos

art.	Ø cm.	h. cm.
41447-05	38	24



W  
SAN  
SS

**Showplate, 3-pcs set**

Vetrina, set 3 pezzi

Buffetvitrine, 3-teilig

Etagère, set 3 pièces

Vitrina, 3 elementos

art.	Ø cm.	h. cm.
41905-38	43	4,5

Roll-top 41447-38 not included.  
Coperchio 41447-38 non incl.



W  
AY  
SS

**Buffet showcase, 2 tiers**

Vetrina 2 piani

Büffet-Vitrine, Doppeldecker

Vitrine 2 étages

Vitrina doble

art.	Ø cm.	h. cm.
41905-03	43,5	50

Roll-top 41447-38 not included.  
Coperchio 41447-38 non incl.



W  
SAN  
SS

**Showplate, 3-pcs set**

Vetrina, set 3 pezzi

Buffetvitrine, 3-teilig

Etagère, set 3 pièces

Vitrina, 3 elementos

art.	Ø cm.	h. cm.	col.
41944-06	38	6	○
41944B06	38	6	●



**SAN**

**Roll-top cover**  
Coperchio roll-top  
Rolltophaube  
Couvercle roll-top  
Campana roll-top

art.	Ø cm.	h. cm.
41945-38	38	20



**AV**

**SS**

**Buffet showcase, 2 tiers**

Vetrina 2 piani  
Büffet-Vitrine, Doppeldecker  
Vitrine 2 étages  
Vitrina doble

art.	dim. cm.
41428-03	61x38x52

**Roll-top lids 41415-11 not included.**  
Coperchi 41415-11 non incl.



**PC**

**Roll-top cover**

Coperchio roll-top  
Rolltophaube  
Couvercle roll-top  
Campana roll-top

art.	dim. cm.	GN
41415-10	53x32,5x17	1/1

**Gold plated knob. – Barretta dorata.**



**PC**

**Roll-top cover**  
Coperchio roll-top  
Rolltophaube  
Couvercle roll-top  
Campana roll-top

art.	dim. cm.	GN
41415-11	53x32,5x17	1/1

**Chrome knob. – Pomolo cromato.**



**SS**

**Showplate, 4-pcs set**

Vetrina, set 4 pezzi  
Buffetvitrine, 4-teilig  
Etagère, set 4 pièces  
Vitrina, 4 elementos

art.	dim. cm.	GN
41907-56	56,5x36x8,5	1/1

**Box + tray GN 1/1 + 2 cooler, without rolltop cover 41415-11. – Base + vassoio + 2 eutettici, coperchio 41415-11 non incl.**



**W**

**Showplate, 4-pcs set**

Vetrina, set 4 pezzi  
Buffetvitrine, 4-teilig  
Etagère, set 4 pièces  
Vitrina, 4 elementos

art.	dim. cm.
41906-60	60x41x5

**Box + tray GN 1/1 + 2 cooler, without rolltop cover 41415-11. – Base + vassoio + 2 eutettici, coperchio 41415-11 non incl.**



**W**

**PP**

**PS**

**Ice-box, 3 pcs set**  
Box portaggiaccio, set 3 pz  
Eisbox, 3-teilig  
Boîte à glaçons, 3 pièces  
Cubitera, 3 elementos

art.	dim. cm.
41412-11	53x32,5x12,5

**Box wenge + plastic deep tray + drainer plate.**  
Base wengé + vasca plastica + griglia.



**SS**

**Showcase, 4-pcs set**

Vetrina, set 4 pezzi  
Buffetvitrine, 4-teilig  
Etagère, set 4 pièces  
Vitrina, 4 elementos

art.	dim. cm.	col.
41940-06	43,5x32,5x6	○
41940B06	43,5x32,5x6	●

**Box, tray, 2 coolers.**  
Contenitore, vassoio, 2 eutettici.



**SAN**

**Roll-top cover**

Coperchio roll-top  
Rolltophaube  
Couvercle roll-top  
Campana roll-top

art.	dim. cm.
41941-44	44x33,5x17





W

**Cutting board**

Tagliere  
Schneidebrett  
Planche à découper  
Tabla de corte

art. dim. cm.  
41941-43 43,5X32,5x2

**For showcases 419040-06, 41940B06.**  
Per vetrine 41940-06, 41940B06.

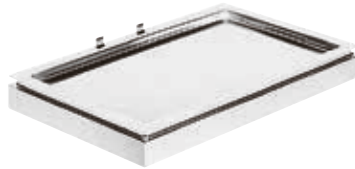

SS

**Cool plate**

Vetrina refrigerata  
Büffet-Vitrine, kühlbar  
Vitrine réfrigérée  
Vitrina refrigerada

art. dim. cm. GN  
42450-00 53x32,5x8,5 1/1

**GN 1/1 base element, s/s platter, cooler.**  
Base GN 1/1, vassoio inox, eutettico.



W  
SS

**Cool plate**

Vetrina refrigerata  
Büffet-Vitrine, kühlbar  
Vitrine réfrigérée  
Vitrina refrigerada

art. dim. cm. GN  
42460-00 53x32,5x8,5 1/1

**GN 1/1 base element, s/s platter, cooler.**  
Base GN 1/1, vassoio inox, eutettico.



W  
SS

**Cool plate**

Vetrina refrigerata  
Büffet-Vitrine, kühlbar  
Vitrine réfrigérée  
Vitrina refrigerada

art. dim. cm. GN  
42470-00 53x32,5x8,5 1/1

**GN 1/1 base element, s/s platter, cooler.**  
Base GN 1/1, vassoio inox, eutettico.



SS

**Eutectic pad**

Accumulatore di freddo  
Kühlakku  
Cartouche eutectique  
Placa eutética

art. dim. cm.  
42450-AD 41x21x2,5



PC

**GN roll-top cover**

Coperchio GN roll-top  
GN-Rolltophaube  
Couvercle roll-top, GN  
Tapa roll-top, GN

art. GN  
42452-53 1/1



GN  
SS

**Tray**

Vassoio  
Tablett  
Plateau  
Bandeja

art. GN  
42451-11 1/1  
42451-12 1/2



W

**Cutting board**

Tagliere  
Tranchierbrett  
Planche à découper  
Plancha para cortar

art. GN  
42470-06 1/1



W

**Cutting board**

Tagliere  
Tranchierbrett  
Planche à découper  
Plancha para cortar

art. GN  
42470-07 1/1



PE

**Cutting board**

Tagliere  
Tranchierbrett  
Planche à découper  
Plancha para cortar

art. GN  
42460-06 1/1



W

**Cooled buffet showcase**

Vetrina refrigerata  
Büffet-Vitrine, kühlbar  
Vitrine réfrigérée  
Vitrina refrigerada

art. dim. cm. col.  
42470-63 63,5x42,5x31 ●

**Woodbase with fixed roll-top cover, plastic case, GN 1/1 melamine tray, cooling unit.** – Base legno con coperchio roll-top fisso, vasca plastica, GN 1/1 in melamina, placca eutettica.



W

**Cooled buffet showcase**

Vetrina refrigerata  
Büffet-Vitrine, kühlbar  
Vitrine réfrigérée  
Vitrina refrigerada

art. dim. cm. col.  
42460-63 63,5x42,5x31 ●

**Woodbase with fixed roll-top cover, plastic case, GN 1/1 melamine tray, cooling unit.** – Base legno con coperchio roll-top fisso, vasca plastica, GN 1/1 in melamina, placca eutettica.





PP  
W

**Cutlery dispenser**  
Portaposate  
Besteck-Behälter  
Bac à couverts  
Caja portacubiertos

art.	dim. cm.	col.
42470-64	57,5x47x12	●



PP  
W

**Cutlery dispenser**  
Portaposate  
Besteck-Behälter  
Bac à couverts  
Caja portacubiertos

art.	dim. cm.	col.
42460-64	57,5x47x12	●



MF

**Bowl**  
Ciotola  
Schüssel  
Bol

art.	Ø cm.	h. cm.	lt.	col.
44837B05	14	6,5	0,5	●
44837B20	20	9,2	1,8	●
44837B25	23	10,0	2,5	●



MF

**Bowl**  
Ciotola  
Schüssel  
Bol

art.	Ø cm.	h. cm.	lt.	col.
44837-05	14	6,5	0,5	○
44837-20	20	9,2	1,8	○
44837-25	23	10,0	2,5	○



**Bowl, glass**  
Ciotola, vetro  
Glasschüssel  
Bol en verre  
Bol vidrio

art.	Ø cm.	h. cm.	lt.
41425-AA	7,5	3,5	0,09
41405-AA	14,0	6,5	0,5
41400-AA	23,0	10,0	2,5



PC

**Airtight cover**  
Coperchio ermetico  
Frischhalte-Deckel  
Couvercle hermétique  
Tapa hermética

art.	Ø cm.
42452-14	14
42452-23	23



PC

**Cover**  
Coperchio  
Deckel  
Couvercle  
Tapa

art.	Ø cm.
42453-23	23



SAN

**Cover**  
Coperchio  
Deckel  
Couvercle  
Tapa

art.	Ø cm.
44837C20	20,5

Matches/Per: 44837-20 & 44837B20.



**Bowl holder, chromed**  
Portaciotole, cromato  
Schalenhalter, Metall hartverchromt  
Étagère à bols, chromée  
Soporte para bols, cromado

art.	Ø cm.	h. cm.
41427-40	18	25,5

For 36 bowls ø cm 7 # 41425-AA.  
Per 36 ciotoline ø cm 7 # 41425-AA.



**Cool bowl**

Ciotola refrigerata  
Kühlschale  
Bol réfrigérée  
Bol refrigerda

art.	dim. cm.	lt.	col.
42470-26	18,5x18,5x10	0,5	●
42470-27	27,5x27,5x14	2,5	●

**Wood base, s/s container, melamine bowl, cooling unit.** – Base legno, contenitore inox, ciotola melamina, placca eutettica.



**Cool bowl**

Ciotola refrigerata  
Kühlschale  
Bol réfrigérée  
Bol refrigerda

art.	dim. cm.	lt.	col.
42460-26	18,5x18,5x10	0,5	●
42460-27	27,5x27,5x14	2,5	●

**Wood base, s/s container, melamine bowl, cooling unit.** – Base legno, contenitore inox, ciotola melamina, placca eutettica.



**Cool bowl**

Ciotola refrigerata  
Kühlschale  
Bol réfrigérée  
Bol refrigerda

art.	Ø cm.	h. cm.	lt.
41448-06	14	9,0	0,6
41448-10	14	11,5	1,0

**Base + cooler + bowl + cover.**  
Base + eutettico + ciotola + coperchio.



**Cool bowl**

Ciotola refrigerata  
Kühlschale  
Bol réfrigérée  
Bol refrigerda

art.	Ø cm.	h. cm.	lt.
41448-25	22	14	2,5
41448-40	22	18	4,0

**Base + cooler + bowl + cover.**  
Base + eutettico + ciotola + coperchio.



**Buffet stand, chrome plated**

Alzata, cromata  
Buffet-Gestell, Metall hartverchromt  
Présentoir, chromé  
Soporte, cromado

art.	dim. cm.
41442-03	61x24x35

**3 glass bowls ø cm 23 + 3 covers.**  
3 ciotole ø cm 23 + covers.



**Serving stand, chrome plated**

Supporto cromato  
Serviergestell, hartverchromt  
Présentoir, acier chromé  
Soporte platos, acero cromado

art.	dim. cm.
44840-06	39x39x17

**For bowls/Per ciotole: 12,5x12,5 e 25x25 cm.**



**Serving stand, chrome plated**

Supporto cromato  
Serviergestell, hartverchromt  
Présentoir, acier chromé  
Soporte platos, acero cromado

art.	dim. cm.
44840-07	55,5x19x15,5

**For bowls 19x19 cm. NOT included.**  
Per ciotole 19x19 cm. NON include.





MF

**Bowl**

Ciotola  
Schüssel  
Bol  
Bol

art.	dim. cm.
44884-12	12,5x12,5x6
44884-19	19x19x9,5
44884-25	25x25x12



MF

**Bowl**

Ciotola  
Schüssel  
Bol  
Bol

art.	dim. cm.
44884B12	12,5x12,5x6
44884B19	19x19x9,5
44884B25	25x25x12



SAN

**Cover**

Coperchio  
Deckel  
Couverture  
Tapa

art.	dim. cm.
44885-19	19x19
44885-25	25x25



**Buffet stand, chrome plated**

Alzata, cromata  
Buffet-Gestell, Metall hartverchromt  
Présentoir, chromé  
Soporte, cromado

art.	dim. cm.
41442-14	30x30x14

**3 glass bowls ø cm 14 + 3 covers.**  
3 ciotole ø cm 14 + covers.



**Buffet stand, chrome plated**

Alzata, cromata  
Buffet-Gestell, Metall hartverchromt  
Présentoir, chromé  
Soporte, cromado

art.	dim. cm.
41442-23	50x50x18

**3 glass bowls ø cm 23 + 3 covers.**  
3 ciotole ø cm 23 + covers.



**Bowl holder, chromed**

Portaciotole, cromato  
Schalenhalter, Metall hartverchromt  
Étagère à bols, chromée  
Soporte para bols, cromado

art.	Ø cm.	h. cm.
41427-40	18	25,5

**For 36 bowls ø cm 7 # 41425-AA.**  
Per 36 ciotoline ø cm 7 # 41425-AA.



**Serving stand, chrome plated**

Alzata, cromata  
Serviergestell, Metall hartverchromt  
Présentoir, chromé  
Soporte platos para buffet, cromado

art.	Ø cm.	h. cm.
42962-04	34	37

**For 4 plates max. Ø 31 cm, inside Ø 23,5 cm.**



**Serving stand, chrome plated**

Alzata, cromata  
Serviergestell, Metall hartverchromt  
Présentoir, chromé  
Soporte platos, cromado

art.	dim. cm.	col.
42962C26	18,5x15,5x26	●
42962C44	29x19,5x43	●

**26: for 3 plates max. Ø 17 cm, inside Ø 10,5 cm**  
**44: for 3 plates max. Ø 27 cm, inside Ø 18 cm**



**Serving stand**

Alzata  
Serviergestell  
Présentoir  
Soporte platos

art.	dim. cm.
42962-26	18,5x15,5x26
42962-30	29x19,5x30
42962-44	29x19,5x43

**26: for 3 plates max. Ø 17 cm, inside Ø 10,5 cm**  
**30: for 2 plates max. Ø 27 cm, inside Ø 18 cm**  
**44: for 3 plates max. Ø 27 cm, inside Ø 18 cm**



**FE**  
**SS**

**Fruit stand**

Espositore porta frutta  
Obstspender  
Etagère à fruits  
Expositor frutas

art.	cap. kg.	h. cm.
41449-27	27,5	32



**FE**  
**SS**

**Fruit stand**

Espositore porta frutta  
Obstspender  
Etagère à fruits  
Expositor frutas

art.	cap. kg.	h. cm.
41449-32	32	53



**SS**

**Fruit stand**

Alzata Royale  
Obstständer  
Etagère Royale  
Expositor de frutas

art.	Ø cm.	h. cm.
41820-03	24-33-42	50



**Buffet ladder, chrome plated**

Espositore buffet, cromato  
Büffet-Leiter, verchromt  
Escalier à buffet, chromé  
Escalera para buffet, cromada

art.	dim. cm.
41912-03	30x30x48

**With 4 bowls ø cm 14 + lids.**  
Con 4 ciotole ø cm 14 + coperchi.



**Buffet ladder, chrome plated**

Espositore buffet, cromato  
Büffet-Leiter, verchromt  
Escalier à buffet, chromé  
Escalera para buffet, cromada

art.	dim. cm.
41912-04	30x30x48

**With 6 bowls ø cm 14. – Con 6 ciotole ø cm 14.**



**Buffet ladder, chrome plated**

Espositore buffet, cromato  
Büffet-Leiter, verchromt  
Escalier à buffet, chromé  
Escalera para buffet, cromada

art.	dim. cm.
41913-03	39x31x66

**With 4 bowls ø cm 23 + lids.**  
Con 4 ciotole ø cm 23 + coperchi.



**Buffet ladder, chrome plated**

Espositore buffet, cromato  
Büffet-Leiter, verchromt  
Escalier à buffet, chromé  
Escalera para buffet, cromada

art.	dim. cm.
41913-04	39x31x66

**With 6 bowls ø cm 23. – Con 6 ciotole ø cm 23.**



**GN**

**Buffet ladder, chrome plated**

Espositore buffet, cromato  
Büffet-Leiter, verchromt  
Escalier à buffet, chromé  
Escalera para buffet, cromada

art.	dim. cm.	GN
41403-01	31,5x32x48	1/3

**For GN pans see page 73.**  
Per contenitori GN vedi pag. 73.





**Buffet ladder, chrome plated**

Espositore buffet, cromato  
Büffet-Leiter, verchromt  
Escalier à buffet, chromé  
Escalera para buffet, cromada

art. dim. cm. GN  
41403-02 31,5x41,5x48 1/2

**For baskets see pages 415-416.**  
Per cesti vedi pagg. 415-416.



**Buffet ladder, chrome plated**

Espositore buffet, cromato  
Büffet-Leiter, verchromt  
Escalier à buffet, chromé  
Escalera para buffet, cromada

art. dim. cm. GN  
41403-03 31,5x56x66 1/2



**Buffet ladder, chrome plated**

Espositore buffet, cromato  
Büffet-Leiter, verchromt  
Escalier à buffet, chromé  
Escalera para buffet, cromada

art. dim. cm. GN  
41403-04 52x59x66 1/1

**For GN pans see page 73.**  
Per contenitori GN vedi pag. 73.



**Multi rack**

Multi-distributore  
Multi Rack  
Distributeur  
Dispensador

art. dim. cm.  
41908-01 26x18x43



**Multi rack**

Multi-distributore  
Multi Rack  
Distributeur  
Dispensador

art. dim. cm.  
41908-00 26x18x43



**Multi rack**

Multi-distributore  
Multi Rack  
Distributeur  
Dispensador

art. dim. cm.  
41911-02 19x24x28



SAN

SS

**Multi rack**  
Multi-distributore  
Multi Rack  
Distributeur  
Dispensador

art. dim. cm.  
41911-03 19x24x41



SAN

SS

**Multi rack**  
Multi-distributore  
Multi Rack  
Distributeur  
Dispensador

art. dim. cm.  
41911-04 19x24x53



W

**Buffet stand**  
Espositore buffet  
Buffetgestell  
Présentoir  
Expositor de buffet

art. dim. cm.  
42460-53 53x21x50

**Shelves/Ripiani: 30 x 15 - 40 x 17,5 - 53 x 19 cm.**



W

**Buffet stand**  
Espositore buffet  
Buffetgestell  
Présentoir  
Expositor de buffet

art. dim. cm.  
42470-53 53x21x50

**Shelves/Ripiani: 30 x 15 - 40 x 17,5 - 53 x 19 cm.**



NEW

W

AR

**2-Tier serving stand**  
Alzata 2 piani  
2-stufiger Servierstand  
Support 2 niveaux  
Soporte 2 pisos

art. dim. cm.  
41207-02 25x4,5x34,5

**Beech. Slate cm. 31x13 - 41x18.**  
Faggio. Ardesia cm. 31x13 - 41x18.



NEW

W

AR

**3-Tier serving stand**  
Alzata 3 piani  
3-stufiger Servierstand  
Support 3 niveaux  
Soporte 3 pisos

art. dim. cm.  
41207-03 25x4,5x54

**Beech. Slate cm. 21x8 - 31x13 - 41x18.**  
Faggio. Ardesia cm. 21x8 - 31x13 - 41x18..



W

**Stand**  
Alzata  
Ständer  
Support  
Soporte

art. dim. cm.  
42463A00 20x20x17,5

**Acacia wood.**



W

**Stand**  
Alzata  
Ständer  
Support  
Soporte

art. dim. cm.  
42463B00 20x20x17,5

**Acacia wood.**



W

**Stand**

Alzata  
Ständer  
Support  
Soporte

art.	Ø cm.	h. cm.
41445-01	15	10
41445-02	35	15

**Acacia wood.**



W

**Cereal-bar**

Espositore cereali  
Cerealien-Buffer-Ständer  
Présentoir à céréales  
Expositor de cereales

art.	dim. cm.	col.
42470-43	43x17x13,5	●

**3 glasses lt. 2 with airtight cover.**  
3 vasi lt. 2 con coperchio ermetico.



W

**Cereal-bar**

Espositore cereali  
Cerealienständer  
Présentoir à céréales  
Expositor de cereales

art.	dim. cm.	col.
42460-43	43x17x13,5	●

**3 glasses lt. 2 with airtight cover.**  
3 vasi lt. 2 con coperchio ermetico.



NEW

**Jam bar**

Espositore marmellate  
Konfitürenständer  
Présentoir à confitures  
Expositor de mermeladas

art.	dim. cm.	ml.
41206-05	34,5x9x8,5	3x176



NEW  
AY

**Cereal-bar**

Espositore per cereali  
Cerealien-Bar  
Présentoir à céréales  
Expositor de cereales

art.	dim. cm.	lt.
41806-03	39,5x12x26	3x1



NEW  
AY

**Cereal pitcher**

Caraffa cereali  
Cerealienkaraffe  
Pichet à céréales  
Jarra de cereales

art.	Ø cm.	dim. cm.	lt.
41806-00	9	25,5	1



SAN  
SS

**Cereal dispenser**

Distributore di cereali  
Müslispender  
Distributeur à céréales  
Dispensador de cereales

art.	dim. cm.	lt.
41810-04	22x17,5x52	4,5



SAN  
SS

**Cereal dispenser**

Distributore di cereali  
Müslispender  
Distributeur à céréales  
Dispensador de cereales

art.	dim. cm.	lt.
41810-09	22x35x52	2x4,5



PC  
SS

**Cereal dispenser**

Distributore di cereali  
Müslispender  
Distributeur à céréales  
Dispensador de cereales

art.	dim. cm.	lt.
41909-08	33x24x64	7





NEW  
PC  
SS

**Cereal dispenser**  
Distributore di cereali  
Müslispender  
Distributeur à céréales  
Dispensador de cereales

art.	dim. cm.	lt.
41807-12	30,5x28,5x60,5	3x4



SS  
NEW

**Juice dispenser**  
Distributore di succhi  
Saftdispenser  
Distributeur à jus  
Dispensador zumos

art.	dim. cm.	lt.
41901-08	36x26x55	8



SS  
NEW

**Juice dispenser duo**  
Distributore di succhi duo  
Saftdispenser duo  
Distributeur à jus duo  
Dispensador de zumo, doble

art.	dim. cm.	lt.
41901-16	36x54x55	2x8



SS  
NEW

**Juice dispenser**  
Distributore di succhi  
Saftdispenser  
Distributeur à jus  
Dispensador zumos

art.	dim. cm.	lt.
18353-17	22x35x56	7



SS  
NEW

**Juice dispenser**  
Distributore di succhi  
Saftdispenser  
Distributeur à jus  
Dispensador zumos

art.	dim. cm.	lt.
41800-05	33x22x52	5



SS  
NEW

**Juice dispenser duo**  
Distributore di succhi duo  
Saftdispenser duo  
Distributeur à jus duo  
Dispensador de zumo, doble

art.	dim. cm.	lt.
41800-10	42,5x30,5x52	2x5

With one cooling pad. – Con 1 eutettico.



SS  
NEW

**Milk dispenser**  
Distributore di latte  
Milchkanne  
Distributeur à lait  
Dispensador de leche

art.	dim. cm.	lt.
41801-05	33x22x50	5



W

**Cereal dispenser**  
Distributore di cereali  
Cerealinspender  
Distributeur à céréales  
Dispensador de cereales

art.	dim. cm.	lt.	col.
42470-45	21x20x55,5	4,5	●
42460-45	21x20x55,5	4,5	●

Maple/Wenge. – Acero/Wengè.



W  
NEW

**Juice dispenser**  
Distributore di succhi  
Saftdispenser  
Distributeur à jus de fruit  
Dispensador de zumo

art.	dim. cm.	lt.
41808-04	16x24x35	4





**Juice dispenser**

Distributore di succhi

Saftdispenser

Distributeur à jus de fruit

Dispensador de zumo

art.	dim. cm.	lt.	col.
42470-74	31x20x42	4	●
42470-76	35,5x22x50	6	●

**Maple. With 2 cooling units. elements, top and base. – Acero. Con 2 eutettici, coperchio e base.**



**Juice dispenser**

Distributore di succhi

Saftdispenser

Distributeur à jus de fruit

Dispensador de zumo

art.	dim. cm.	lt.	col.
42460-74	31x20x42	4	●
42460-76	35,5x22x50	6	●

**Wenge. With 2 cooling units. elements, top and base. – Wengè. Con 2 eutettici, coperchio e base.**



**Juice dispenser**

Distributore di succhi

Saftdispenser

Distributeur à jus

Dispensador zumos

art.	dim. cm.	lt.
41907-04	21x31x44	4
41907-06	23x35x52	6

**Beechwood. With cooling pads. Faggio. Con eutettici**



**Juice dispenser duo**

Distributore di succhi duo

Saftdispenser duo

Distributeur à jus duo

Dispensador de zumo, doble

art.	dim. cm.	lt.
41907-02	42x35x52	2x6

**Beechwood. With cooling pads. Faggio. Con eutettici**



**Milk dispenser**

Distributore di latte

Milchkanne

Distributeur à lait

Dispensador de leche

art.	dim. cm.	lt.
41920-03	21x32x39	3
41920-05	23x35x52	5

**Beechwood. With cooling pads. Faggio. Con eutettici**



**Milk dispenser**

Distributore di latte

Milchkanne

Distributeur à lait

Dispensador de leche

art.	dim. cm.	lt.
41900-04	23x32x42	4
41900-10	27x38,5x45	10

**Beechwood. With cooling pads. Faggio. Con eutettici**



**Insulated dispenser**

Distributore termico

Iso-Dispenser

Distributeur isothermique

Dispensador térmico

art.	Ø cm.	h. cm.	lt.
41904-10	24	42>46,5	9,5



**Air pot**

Caraffa termica

Thermopumpkanne

Pot à air isothermique

Jarra térmica

art.	lt.
42406-35	3,5
42406-40	4,0



**Air pot**

Caraffa termica

Thermopumpkanne

Pot à air isothermique

Jarra térmica

art.	lt.
42400-19	1,9
42400-25	2,5
42400-30	3,0

# SERIES 12300

BUFFET LIVE COOKING

NEW     INDUCTION READY!



Paderno serie 12300 3-ply is especially designed for use in front of house and live cooking stations. Features super heat-conductive multi-layer construction that distributes heat from bottom to rim quickly and evenly. An attractive, multifunctional and colored line available in white, yellow, green, blue and orange. External finish with special heat-resistant paint (Whitford technology). Ideal for all types of cooking including induction. The lid equipped with a steam release device can be hooked to the side of the pan.

La serie Paderno 12300 3-ply è concepita per l'uso "front of house" e per le "live cooking stations". Costruita in materiale multistrato, assicura una distribuzione rapida ed uniforme del calore su tutta la superficie dell'utensile. Una linea attrattiva, multifunzionale e colorata disponibile nelle varianti bianco, giallo, verde, blu e arancio. Finitura esterna con speciale vernice (tecnologia Whitford) resistente al calore. Ideali per ogni tipo di cottura inclusa l'induzione. Il coperchio dotato di dispositivo di rilascio del vapore, può essere agganciato a lato della casseruola



**Stew pan with lid**

Casseruola con coperchio  
Brattpf mit Deckel  
Sautoir avec couvercle  
Sartén con tapa

art.	Ø cm.	h. cm.	lt.
12303W16	16	8	1,6
12303W20	20	10	3,1
12303W24	24	12	5,4



**Stew pan with lid**

Casseruola con coperchio  
Brattpf mit Deckel  
Sautoir avec couvercle  
Sartén con tapa

art.	Ø cm.	h. cm.	lt.
12303Y16	16	8	1,6
12303Y20	20	10	3,1
12303Y24	24	12	5,4



**Stew pan with lid**

Casseruola con coperchio  
Brattpf mit Deckel  
Sautoir avec couvercle  
Sartén con tapa

art.	Ø cm.	h. cm.	lt.
12303G16	16	8	1,6
12303G20	20	10	3,1
12303G24	24	12	5,4



**Stew pan with lid**

Casseruola con coperchio  
Brattpf mit Deckel  
Sautoir avec couvercle  
Sartén con tapa

art.	Ø cm.	h. cm.	lt.
12303B16	16	8	1,6
12303B20	20	10	3,1
12303B24	24	12	5,4



**Stew pan with lid**

Casseruola con coperchio  
Brattpf mit Deckel  
Sautoir avec couvercle  
Sartén con tapa

art.	Ø cm.	h. cm.	lt.
12303O16	16	8	1,6
12303O20	20	10	3,1
12303O24	24	12	5,4



**Roasting pan with lid**

Casseruola carrè con coperchio  
Bräter mit Deckel  
Rôtissoire avec couvercle  
Asadera con tapa

art.	dim. cm.	h. cm.	lt.
12304W26	27x27	7	4



**Roasting pan with lid**

Casseruola carrè con coperchio  
Bräter mit Deckel  
Rôtissoire avec couvercle  
Asadera con tapa

art.	dim. cm.	h. cm.	lt.
12304Y26	27x27	7	4



**Roasting pan with lid**

Casseruola carrè con coperchio  
Bräter mit Deckel  
Rôtissoire avec couvercle  
Asadera con tapa

art.	dim. cm.	h. cm.	lt.
12304G26	27x27	7	4



**Roasting pan with lid**

Casseruola carrè con coperchio  
Bräter mit Deckel  
Rôtissoire avec couvercle  
Asadera con tapa

art.	dim. cm.	h. cm.	lt.
12304B26	27x27	7	4



**Roasting pan with lid**

Casseruola carrè con coperchio  
Bräter mit Deckel  
Rôtissoire avec couvercle  
Asadera con tapa

art.	dim. cm.	h. cm.	lt.
12304O26	27x27	7	4



**Bowl double wall**

Ciotola doppia parete  
Schüssel, doppelwandig  
Bol à double paroi  
Tazón doble pared

art.	Ø cm.	h. cm.
12300-18	18	14,0
12300-24	24	18,2



**Bowl double wall**

Ciotola doppia parete  
Schüssel, doppelwandig  
Bol à double paroi  
Tazón doble pared

art.	Ø cm.	h. cm.
12300W18	18	14,0
12300W24	24	18,2



**Bowl double wall**  
Ciotola doppia parete  
Schüssel, doppelwandig  
Bol à double paroi  
Tazón doble pared

art.	Ø cm.	h. cm.
12300Y18	18	14,0
12300Y24	24	18,2



**Bowl double wall**  
Ciotola doppia parete  
Schüssel, doppelwandig  
Bol à double paroi  
Tazón doble pared

art.	Ø cm.	h. cm.
12300G18	18	14,0
12300G24	24	18,2



**Bowl double wall**  
Ciotola doppia parete  
Schüssel, doppelwandig  
Bol à double paroi  
Tazón doble pared

art.	Ø cm.	h. cm.
12300B18	18	14,0
12300B24	24	18,2



**Bowl double wall**  
Ciotola doppia parete  
Schüssel, doppelwandig  
Bol à double paroi  
Tazón doble pared

art.	Ø cm.	h. cm.
12300O18	18	14,0
12300O24	24	18,2



# ATLANTIC BUFFET SYSTEM

BUFFET & PRESENTATION



Conceived and designed in the round and rectangular versions with different opening systems to meet any need ABS Atlantic Buffet System chafing dishes combine contemporary flexibility and functionality. All the parts of these simple-shaped, stackable, 100% stainless steel hygienic items can be easily taken apart for thorough cleaning.

The line comes from the expertise that only Sambonet Paderno can offer to top catering services. The lid is equipped with a new, transparent window made of unbreakable glass that lets you see the delicacies held in the chafing dishes. The gradual closing mechanism and the special lid removal method make the whole System even more effective.

Pensati e ideati nelle versioni rotonde, rettangolari con aperture differenziate per soddisfare ogni esigenza, gli scaldavivande ABS Atlantic Buffet System interpretano la funzionalità e la flessibilità contemporanea. Semplici nella forma, impilabili, igienici poiché realizzati in acciaio inox, facilmente smontabili in tutte le loro parti per una pulizia impeccabile, gli elementi appartenenti alla linea nascono dall'expertise che solo Sambonet Paderno è in grado di garantire alla ristorazione d'eccellenza. Grazie alla trasparenza del nuovo oblò in vetro temperato, i coperchi offrono visibilità alla prelibatezza dei contenuti degli scaldavivande. Il meccanismo di chiusura graduale e lo speciale metodo di rimozione dei coperchi rende ancora più performante l'intero Sistema.



**TOP UNIT - Chafing dish round**

Scaldavivande tondo  
Chafing Dish, rund  
Chafing dish rond  
Chafing dish redondo

art.	Ø cm.	h. cm.	lt.
18176-30	30	15	2,8
18176-36	36	15	5,0
18176-40	40	17	7,8



**TOP UNIT - Chafing dish round**

Scaldavivande tondo  
Chafing Dish, rund  
Chafing dish rond  
Chafing dish redondo

art.	Ø cm.	h. cm.	lt.
18176I30	30	15	2,8
18176I36	36	15	5,0
18176I40	40	17	7,8



**TOP UNIT - Chafing dish round**

Scaldavivande tondo  
Chafing Dish, rund  
Chafing dish rond  
Chafing dish redondo

art.	Ø cm.	h. cm.	lt.
18166-24	24	15	2,0
18166-30	30	15	2,8
18166-36	36	15	5,0
18166-40	40	17	7,8



**TOP UNIT - Chafing dish round**

Scaldavivande tondo  
Chafing Dish, rund  
Chafing dish rond  
Chafing dish redondo

art.	Ø cm.	h. cm.	lt.
18166I30	30	15	2,8
18166I36	36	15	5,0
18166I40	40	17	7,8



**TOP UNIT - Chafing dish rectangular**

Scaldavivande rettangolare  
Chafing Dish, rechteckig  
Chafing dish rectangulaire  
Chafing dish rectangular

art.	dim. cm.	lt.
18172-54	57x47x18	10

**Long side opening.** – Apertura lato lungo.



**TOP UNIT - Chafing dish rectangular**

Scaldavivande rettangolare  
Chafing Dish, rechteckig  
Chafing dish rectangulaire  
Chafing dish rectangular

art.	dim. cm.	lt.
18172-56	68,5x35,5x18	10

**Short side opening.** – Apertura lato corto.





**TOP UNIT - Chafing dish rectangular**

Scaldavivande rettangolare  
Chafing Dish, rechteckig  
Chafing dish rectangulaire  
Chafing dish rectangular

art.	dim. cm.	lt.
18162-54	57x47x18	10

**Long side opening.** – Apertura lato lungo.



**TOP UNIT - Chafing dish rectangular**

Scaldavivande rettangolare  
Chafing Dish, rechteckig  
Chafing dish rectangulaire  
Chafing dish rectangular

art.	dim. cm.	lt.
18162-56	68,5x35,5x18	10

**Short side opening.** – Apertura lato corto.

## ATLANTIC BUFFET SYSTEM INDUCTION HOBS

**ABS-Atlantic Buffet System chafing dishes can be used on any heat source, gas, electric, glass-ceramic and induction\*. We recommend our free-standing (58162-RA) and built-in (58162-RB) cookers.**

**As a matter of fact, these induction cookers are ideal for any buffet where food should be kept at a specific temperature to preserve flavours.**

**\*NOT SUITABLE for induction hobs with frequency identification.**

Gli scaldavivande ABS-Atlantic Buffet System sono ideati per ogni tipo di cottura, gas, elettrica, vetroceramica e induzione\* per la quale si raccomanda l'utilizzo delle piastre proposte dall'azienda, disponibili sia nella versione da appoggio art. 58162-RA sia da incasso art. 58162-RB. Questi piani ad induzione sono infatti l'ideale per tutti i buffet ove indispensabile mantenere i cibi ad una temperatura ottimale per la conservazione dei sapori.

\*NON UTILIZZABILI su piani ad induzione con riconoscimento di frequenza.



**Induction cooker, to be built into counter**

Piastra ad induzione, da incasso  
Induktionsplatte, thekeneinbau  
Plaque à induction, montage en comptoir  
Placa a inducción para emportar

art.	dim. cm.
18162-RB	36X38x12,5

**Schott ceran hob, timer (0-180 min.), 1-10 power levels, temperature range 60°C-240°C.**

Piano in vetroceramica Schott, timer 0-180 minuti, 1-10 livelli di potenza, temperatura 60-240°C.



**Induction cooker**

Piastra ad induzione  
Induktionsplatte  
Plaque à induction  
Placa a inducción

art.	dim. cm.
18162-RA	30X37x10

**Stainless steel body, Schott ceran hob, led display, timer (0-180 min.), 1-10 power levels, temperature range 60°C-240°C.**

Corpo inox, piano in vetroceramica Schott, display a led, timer 0-180 minuti, 1-10 livelli di potenza, temperatura 60-240°C.





### BUILT-IN UNIT - Chafing dish rectangular

Scaldavivande rettangolare  
Chafing Dish, rechteckig  
Chafing dish rectangulaire  
Chafing dish rectangular

art.	dim. cm.	lt.	std	V-W
18162A55	57x47x18	10		
18162E55	57x47x18	10	EU	250-360
18162U55	57x47x18	10	US	120-450

**Long side opening.** – Apertura lato lungo.



art.	dim. cm.	lt.	std	V-W
18162A57	68,5x35,5x18	10		
18162E57	68,5x35,5x18	10	EU	250-360
18162U57	68,5x35,5x18	10	US	120-450

**Short side opening.** – Apertura lato corto.



art.	dim. cm.	lt.	std	V-W
18172A55	57x47x18	10		
18172E55	57x47x18	10	EU	250-360
18172U55	57x47x18	10	US	120-450

**Long side opening.** – Apertura lato lungo.



art.	dim. cm.	lt.	std	V-W
18172A57	68,5x35,5x18	10		
18172E57	68,5x35,5x18	10	EU	250-360
18172U57	68,5x35,5x18	10	US	120-450

**Short side opening.** – Apertura lato corto.



**ATLANTIC ON STAND UNITS - CON SUPPORTO**



**Chafing dish, solid alcohol heating**  
Scaldavivande a combustibile solido  
Chafing Dish mit Brennstoff beheizt  
Chafing dish chauffage combustible solide  
Chafing dish calefacción combustible sólido

art.	Ø cm.	h. cm.	lt.
18176A30	30	27	2,8
18176A36	36	27	5,0
18176A40	40	28	7,8



**Chafing dish, solid alcohol heating**  
Scaldavivande a combustibile solido  
Chafing Dish mit Brennstoff beheizt  
Chafing dish chauffage combustible solide  
Chafing dish calefacción combustible sólido

art.	Ø cm.	h. cm.	lt.
18166A24	24	27	2,0
18166A30	30	27	2,8
18166A36	36	27	5,0
18166A40	40	28	7,8



**Chafing dish, electric heating**  
Scaldavivande, riscaldamento elettrico  
Chafing Dish, elektrisch beheizt  
Chafing dish chauffage électrique  
Chafing dish calefacción eléctrica

art.	Ø cm.	h. cm.	lt.	std	V-W
18176E30	30	27	2,8	EU	250-190
18176E36	36	27	5,0	EU	250-190
18176E40	40	28	7,8	EU	250-190
18176U36	36	27	5,0	US	120-240
18176U40	40	28	7,8	US	120-240



**Chafing dish, electric heating**  
Scaldavivande, riscaldamento elettrico  
Chafing Dish, elektrisch beheizt  
Chafing dish chauffage électrique  
Chafing dish calefacción eléctrica

art.	Ø cm.	h. cm.	lt.	std	V-W
18166E24	24	27	2,0	EU	250-80
18166E30	30	27	2,8	EU	250-190
18166E36	36	27	5,0	EU	250-190
18166E40	40	28	7,8	EU	250-190
18166U24	24	27	2,0	US	120-170
18166U36	36	27	5,0	US	120-240
18166U40	40	28	7,8	US	120-240



**Petite marmite**  
Petite marmite  
Petite Marmite  
Petite marmite  
Petite marmite

art.	Ø cm.	h. cm.	lt.	std	V-W
18168A24	24	35	7	-	-
18168E24	24	35	7	EU	250-80
18168U24	24	35	7	US	120-170



**Chafing dish rectangular**  
Scaldavivande rettangolare  
Chafing Dish, rechteckig  
Chafing dish rectangulaire  
Chafing dish rectangular

art.	dim. cm.	lt.	std	V-W
18172A54	57x47x30,5	10	-	-
18172E54	57x47x30,5	10	EU	250-360
18172U54	57x47x30,5	10	US	120-450



**Chafing dish rectangular**  
Scaldavivande rettangolare  
Chafing Dish, rechteckig  
Chafing dish rectangulaire  
Chafing dish rectangular

art.	dim. cm.	lt.	std	V-W
18172A56	68,5x35,5x30,5	10	-	-
18172E56	68,5x35,5x30,5	10	EU	250-360
18172U56	68,5x35,5x30,5	10	US	120-450



**Chafing dish rectangular**  
Scaldavivande rettangolare  
Chafing Dish, rechteckig  
Chafing dish rectangulaire  
Chafing dish rectangular

art.	dim. cm.	lt.	std	V-W
18162A54	57x47x30,5	10	-	-
18162E54	57x47x30,5	10	EU	250-360
18162U54	57x47x30,5	10	US	120-450



**Chafing dish rectangular**  
Scaldavivande rettangolare  
Chafing Dish, rechteckig  
Chafing dish rectangulaire  
Chafing dish rectangular

art.	dim. cm.	lt.	std	V-W
18162A56	68,5x35,5x30,5	10	-	-
18162E56	68,5x35,5x30,5	10	EU	250-360
18162U56	68,5x35,5x30,5	10	US	120-450



**ASIA LINE**



**Chafing dish rectangular**  
Scaldavivande rettangolare  
Chafing Dish, rechteckig  
Chafing dish rectangulaire  
Chafing dish rectangular

art.	dim. cm.	lt.	std	V-W
18132A54	67,5x44x42	10	-	-
18132E54	67,5x44x42	10	EU	250-360
18132U54	67,5x44x42	10	US	120-450



**Chafing dish, to be built in**  
Scaldavivande da incasso  
Einbau Chafing Dish  
Chafing dish encastrable  
Chafing dish encastrable

art.	dim. cm.	lt.	std	V-W
18132A55	67,5x44x34,5	10	-	-
18132E55	67,5x44x34,5	10	EU	250-360
18132U55	67,5x44x34,5	10	US	120-450



**Chafing dish round**  
Scaldavivande tondo  
Chafing Dish, rund  
Chafing dish rond  
Chafing dish redondo

art.	Ø cm.	h. cm.	lt.	std	V-W
18136A33	33	44	3,5	-	-
18136E33	33	44	3,5	EU	250-200
18136U33	33	44	3,5	US	120-240
18136A40	40	58	6,0	-	-
18136E40	40	58	6,0	EU	250-360
18136U40	40	58	6,0	US	120-450



**Chafing dish round, to be built in**  
Scaldavivande tondo da incasso  
Einbau Chafing Dish, rund  
Chafing dish rond, encastrable  
Chafing dish redondo encastrable

art.	Ø cm.	h. cm.	lt.	std	V-W
18136A34	33	34,5	3,5	-	-
18136E34	33	34,5	3,5	EU	250-200
18136U34	33	34,5	3,5	US	120-240
18136A41	40	43,0	6,0	-	-
18136E41	40	43,0	6,0	EU	250-360
18136U41	40	43,0	6,0	US	120-450



**Chafing dish rectangular**

Scaldavivande rettangolare  
Chafing Dish, rechteckig  
Chafing dish rectangulaire  
Chafing dish rectangular

art.	dim. cm.	lt.	std	V-W
18152A54	67x49x44	10	-	-
18152E54	67x49x44	10	EU	250-360
18152U54	67x49x44	10	US	120-450



**Chafing dish round**

Scaldavivande tondo  
Chafing Dish, rund  
Chafing dish rond  
Chafing dish redondo

art.	Ø cm.	h. cm.	lt.	std	V-W
18156A33	33	47	3,5	-	-
18156E33	33	47	3,5	EU	250-200
18156U33	33	47	3,5	US	120-240
18156A40	40	61	6,0	-	-
18156E40	40	61	6,0	EU	250-360
18156U40	40	61	6,0	US	120-450



**Chafing dish rectangular**

Scaldavivande rettangolare  
Chafing Dish, rechteckig  
Chafing dish rectangulaire  
Chafing dish rectangular

art.	dim. cm.	lt.	std	V-W
41690A11	63,5x35x32	8,5	-	-
41690E11	63,5x35x32	8,5	EU	250-360
41690U11	63,5x35x32	8,5	US	120-450

**NEW**



**Chafing dish rectangular**

Scaldavivande rettangolare  
Chafing Dish, rechteckig  
Chafing dish rectangulaire  
Chafing dish rectangular

art.	dim. cm.	lt.	std	V-W
41691A11	71,5x52x45	8,5	-	-
41691E11	71,5x52x45	8,5	EU	250-360
41691U11	71,5x52x45	8,5	US	120-450

**NEW**



**Coffee urn**

Scaldacaffè  
Kaffeedispenser  
Réchaud à café  
Calentador de café

art.	dim. cm.	lt.	std	V-W
41903A10	31x33,5x54,5	10,5	-	-
41903E10	31x33,5x54,5	10,5	EU	220-80
41903U10	31x33,5x54,5	10,5	US	110-170

**NEW**





**Samovar**

**Pyramid**

**NEW**

art.	dim. cm.	lt.	Tea pot	std	V-W
49856-04	35,5x30x45,2	4	Lt 1,2	EU	2500

**Teapot with strainer. Cable length approx. 130 cm. With 2 heating elements 2000W and 500W.**  
Teiera con colino. Lunghezza cavo circa 130 cm. Con 2 resistenze 2000W e 500W.



**Samovar**

**2017**

**NEW**

art.	dim. cm.	lt.	Tea pot	std	V-W
49854-03	31x27,5x48,5	3	Lt 1,2	EU	1500

**Teapot with strainer, cable length approx. 130 cm. – Teiera con colino. Lunghezza cavo circa 130 cm.**



**Samovar**

**Romanov**

**NEW**

art.	dim. cm.	lt.	Tea pot	std	V-W
49855-05	34x27x59	5	Lt 1,3	EU	1800

**Teapot with strainer. Cable length approx. 100 cm. With 2 heating elements 1300W and 500W.**  
Teiera con colino. Lunghezza cavo circa 100 cm. Con 2 resistenze 1300W e 500W.



**Samovar**

**3006C**

**NEW**

art.	dim. cm.	lt.	Tea pot	std	V-W
49854-06	35,5x30x45,2	6	Lt 1,5	EU	2500

**Teapot with strainer. With 2 heating elements 2000W and 500W. – Teiera con colino. Con 2 resistenze 2000W e 500W.**



**Samovar**  
Soraya

NEW

art.	dim. cm.	lt.	Tea pot	std	V-W
49855-10	35,2x44,5x69	10	Lt 1,6	EU	3000

**Teapot with strainer. Cable length approx. 130 cm. With 2 heating elements 2300W and 700W.**  
Teiera con colino. Lunghezza cavo circa 130 cm. Con 2 resistenze 2300W e 700W.



**Samovar**  
Katharina

NEW

art.	dim. cm.	lt.	Tea pot	std	V-W
49855-15	39,5x44,5x74,5	15	Lt 2,0	EU	3000

**Teapot with strainer. Cable length approx. 130 cm. With 2 heating elements 2300W and 700W.**  
Teiera con colino. Lunghezza cavo circa 130 cm. Con 2 resistenze 2300W e 700W.



**Coffee percolator**  
Percolatore per caffè  
Kaffee-Perkolator  
Percolateur à café  
Percolator de café

art.	Ø cm.	h. cm.	lt.	std	V-W
49846-05	28	38,5	4,5	EU	950
49846-09	28	38,5	9,2	EU	950
49846-15	33	54	15	EU	1650



**Soup kettle**  
Zuppiera  
Suppenwärmer  
Marmite à soupe  
Olla de sopa

art.	Ø cm.	h. cm.	lt.	std	V-W
49847-38	38	36,5	10	EU	230-450/550



**Soup kettle**  
Zuppiera  
Suppenwärmer  
Marmite à soupe  
Olla de sopa

art.	Ø cm.	h. cm.	lt.	std	V-W
49804-11	34	33	11	EU	230-850





**Soup kettle**  
Zuppiera  
Suppenwärmer  
Marmite à soupe  
Olla de sopa

art.	Ø cm.	h. cm.	lt.	std	V-W
49847-08	33	37	10	EU	230-400



**Soup kettle**  
Zuppiera  
Suppenkessel  
Marmite à soupe  
Olla de sopa

art.	Ø cm.	h. cm.	lt.
49790-09	48	32	10





ACCESSORIES, SPARE PARTS AND COMPONENTS



**Round stand**

Supporto rotondo  
Gestell, rund  
Support rond  
Soporte redondo

art.	Ø cm.
18166-AA	24
18166-AM	30
18166-AB	36
18166-AC	40



**Rectangular stand**

Supporto rettangolare  
Gestell, rechteckig  
Support rectangulaire  
Soporte rectangular

art.	dim. cm.
18162-AA	57x47



**Round food pan, stainless steel**

Portavivande tondo, inox  
Einsatzbehälter, rund, Edelstahl Rostfrei  
Bac rond, inox  
Baño-maria redondo, inox

art.	Ø cm.	h. cm.	lt.
18136-EA	33	6,0	3,5
18136-EB	40	7,5	6,0

**For ASIA round chafing dishes.** – Per scaldavivande ASIA tondi.



**Round food pan, stainless steel**

Portavivande tondo, inox  
Einsatzbehälter, rund, Edelstahl Rostfrei  
Bac rond, inox  
Baño-maria redondo, inox

art.	Ø cm.
18166-EG	24
18166-EM	30
18166-EH	36
18166-EI	40

**For ABS round chafing dishes.** – Per scaldavivande ABS tondi.



**Round porcelain insert**

Inserto tondo, porcellana  
Porzellaneinsatz, rund  
Bac rond, porcelaine  
Baño-maria redondo, porcelana

art.	Ø cm.	h. cm.
44352-30	33	5,7
44352-40	40	7,5

**For ASIA round chafing dishes.** – Per scaldavivande ASIA tondi.



**Round porcelain insert, 2 food sections**

Inserto tondo, porcellana, 2 scomparti  
Porzellaneinsatz 2-tlg., rund  
Bac rond, porcelaine, 2 compartements  
Baño-maria redondo, porcelana 2 compartimentos

art.	Ø cm.	h. cm.
44355-30	33	5,7
44355-40	40	7,5

**For ASIA round chafing dishes.** – Per scaldavivande ASIA tondi.





**Round porcelain insert**

Inserto tondo, porcellana  
Porzellaneinsatz, rund  
Bac rond, porcelaine  
Baño-maria redondo, porcelana

art.	Ø cm.
18166-EL	30
18166-EC	36
18166-EB	40

**For ABS round chafing dishes. – Per scaldavivande ABS tondi.**



**Round porcelain insert, 2 food sections**

Inserto tondo, porcellana, 2 scomparti  
Porzellaneinsatz 2-tlg., rund  
Bac rond, porcelaine, 2 compartements  
Baño-maria redondo, porcelana 2 compartimentos

art.	Ø cm.
18166-ED	36
18166-EJ	40

**For ABS round chafing dishes. – Per scaldavivande ABS tondi.**



**Food pan GN 1/1, stainless steel**

Bacinella GN 1/1, inox  
GN-Behälter 1/1, Edelstahl Rostfrei  
Bac GN 1/1, inox  
Baño-maria GN 1/1, inox

art.	dim. cm.
14102-04	53x32,5x4
14102-06	53x32,5x6,5



**Food pan GN 1/1, porcelain**

Bacinella GN 1/1, porcellana  
GN-Behälter 1/1, Porzellan  
Bac GN 1/1, porcelaine  
Baño-maria GN 1/1, porcelana

art.	dim. cm.
44332-03	53x32,5x2
44332-06	53x32,5x6,5



**Fuel Holder, stainless steel**

Portacombustibile, inox  
Brennstoffhalterung, Edelstahl Rostfrei  
Porte Brûleur, inox  
Contenedor de combustible, inox

art.	Ø cm.	h. cm.
41809-09	9	6,5

**Suitable for chafing dishes items 41690 and 41691.**

Adatto per gli scaldavivande art. 41690 e 41691.



**Fuel Holder, stainless steel**

Portacombustibile, inox  
Brennstoffhalterung, Edelstahl Rostfrei  
Porte Brûleur, inox  
Contenedor de combustible, inox

art.	Ø cm.	h. cm.
18132-FB	10	7,5

**Suitable for chafing dishes items 18152 and 18156.**

Adatto per gli scaldavivande art. 18152 e 18156.



**Fuel Holder, stainless steel**

Portacombustibile, inox  
Brennstoffhalterung, Edelstahl Rostfrei  
Porte Brûleur, inox  
Contenedor de combustible, inox

art.
18136-KA

**Kit for ABS round ø cm 24-30-36. – Set per scaldavivande ABS ø cm 24-30-36.**



**Fuel Holder, stainless steel**

Portacombustibile, inox  
Brennstoffhalterung, Edelstahl Rostfrei  
Porte Brûleur, inox  
Contenedor de combustible, inox

art.
18132-KA

**Kit for ABS rectangular and round ø cm 40. – Set per scaldavivande ABS rettangolari e ø cm 40.**



**Soup tureen without lid**

Zuppiera senza coperchio  
Suppenschüssel ohne Deckel  
Soupière sans couvercle  
Sopera sin tapa

art.	Ø cm.	lt.
18168-GA	24	7



**Jelly fuel**

Gel combustibile  
Brenngel  
Gel combustible  
Combustible gel

art.	lt.	gr.	U. Pack
41695-15	-	200	2
41695-10	1	-	-
41695-50	5	-	-
41695-90	10	-	-



**Thermoregulator**

Termoregolatore  
Thermoregler  
Thermorégulateur  
Teromorregulador

art.	std
18132-AE	EU



**Thermoregulator**

Termoregolatore  
Thermoregler  
Thermorégulateur  
Teromorregulador

art.	std
18132-AU	US

**For rectangular and round units ø cm 30-33-36-40.**  
Per scaldavivande rettangolari e tondi ø cm 30-33-36-40.

**For rectangular and round units ø cm 30-33-36-40.**  
Per scaldavivande rettangolari e tondi ø cm 30-33-36-40.



**Electric heating units**

Piastre elettriche  
Elektro-Heizelemente  
Corps de chauffe électriques  
Calentadores eléctricos

art.	std	V-W
18136-KE	EU	220-200
18136-KU	US	110-240

**Cm. 20x20 - For ASIA round chafing dishes cm 33.** – Per scaldavivande ASIA tondo cm 33.



**Electric heating units**

Piastre elettriche  
Elektro-Heizelemente  
Corps de chauffe électriques  
Calentadores eléctricos

art.	std	V-W
18166-KP	EU	220-180

**Cm. 20x21 - For ABS round ø cm 30.**  
Per scaldavivande ABS tondo ø cm 30.



**Electric heating units**

Piastre elettriche  
Elektro-Heizelemente  
Corps de chauffe électriques  
Calentadores eléctricos

art.	std	V-W
18166-KE	EU	220-200
18166-KU	US	110-240

**Cm. 20x25 - For ABS round ø cm 36-40.**  
Per scaldavivande ABS tondo ø cm 36-40.



**Electric heating units**

Piastre elettriche  
Elektro-Heizelemente  
Corps de chauffe électriques  
Calentadores eléctricos

art.	std	V-W
18132-KE	EU	220-380
18132-KU	US	110-450

**Cm. 20x25 - For ASIA rectangular and round chafing dishes cm 40.** – Per scaldavivande ASIA rettangolari e tondi cm 40.



**Electric heating units**

Piastre elettriche  
Elektro-Heizelemente  
Corps de chauffe électriques  
Calentadores eléctricos

art.	std	V-W
18162-KE	EU	220-380
18162-KU	US	110-450

**Cm. 20x25 - For ABS rectangular.**  
Per scaldavivande ABS rettangolari.



**Electric heating units**

Piastre elettriche  
Elektro-Heizelemente  
Corps de chauffe électriques  
Calentadores eléctricos

art.	std	V-W
18341-KE	EU	220-80
18341-KU	US	110-170

**Cm. Ø 13,5 - For ABS round ø cm 24.**  
Per scaldavivande ABS tondo ø cm 24.

# SERIES VERSAILLES

DINING ROOM TROLLEYS  
CARRELLI SALA



Main structure and tops in plywood with reinforced edges. Legs in beechwood. Standard finishing rosewood color. Other colors: walnut, mahogany and oak. Standard swivel casters in antistatic rubber, on request polyurethane casters. All trolleys are available equipped with rubber bumper.

Struttura portante, piani di servizio in legno multistrato con bordi massicci. Gambe in massello di faggio. Finitura standard tinta palissandro. Su richiesta colori: noce, mogano e rovere. Ruote standard in gomma antistatica, optional ruote in poliuretano. Tutti i carrelli possono essere dotati di profilo paraurti.



**Roast beef/stew trolley**

Carrello arrostiti/bolliti  
Rinderbrust-/Fleischgerichtewagen  
Chariot à rôtis  
Carro roast beef

art.	dim. cm.	Kg.	V	W	color	col.
18874-11	126x62x109	54	120	600	rosewood	●
18874M11	126x62x109	54	120	600	mahogany	●
18874N11	126x62x109	54	120	600	walnut	●
18874R11	126x62x109	54	120	600	oak	●
18874-22	126x62x109	54	230	700	rosewood	●
18874M22	126x62x109	54	230	700	mahogany	●
18874N22	126x62x109	54	230	700	walnut	●
18874R22	126x62x109	54	230	700	oak	●

**18-10 s/s revolving top adjustable up to 180°, mirror polish finishing - 4 swivel casters, 2 with brakes, bain-marie tank with 3 GN 1/2 10 litres each - removable wilsonart cutting board mm 354x265 revolving plate rack and removable knife holder in 18-10 s/s - 2 taps for water discharge - 2 heating units 700W each - 1 built in plug, backside - 3 built-in plugs, deck downside - 2 pipe plugs - cable - 3 switches, (1 magneto-thermic).** – Cloche inox 18-10 lucido a specchio, apertura a scomparsa a 180° - 4 ruote pivotanti, 2 con freno – vasca bagnomaria con 3 portavivande GN 1/2 da lt 10 cad. - tagliere mobile in wilsonart, mm 354x265 - portapiatti ribaltabile e portacoltelli estraibile in acciaio inox 18-10 - 2 rubinetti di scarico a sfera - 2 piastre elettriche da 700W cad. - 1 spina ad incasso (posteriore carrello) - 3 prese ad incasso (sotto piano carrello) - 2 spine a pipa - cavo di alimentazione - 3 interruttori di cui 1 magnetotermico.



**Flambé trolley**

Carrello flambé  
Flambierwagen  
Chariot à flamber  
Carro flambé

art.	dim. cm.	Kg.	color	col.
18876-00	122x58,5x89,5	44,5	rosewood	●
18876M00	122x58,5x89,5	44,5	mahogany	●
18876N00	122x58,5x89,5	44,5	walnut	●
18876R00	122x58,5x89,5	44,5	oak	●

**4 swivel casters, 2 with brakes - upper deck in 18-10 stainless steel mm 540x1042 with bottle holder protection ring - 2 lower wooden decks - cabinet for gas cylinder - gas/burning/lighting unit - piezoelectric lighting device - operating with liquid butan gas, 2,75 kg rechargeable cylinder (lasting for 20 hours about) or 1,8 kg cylinder - trolley supplied without cylinder.**

4 ruote pivotanti di cui 2 con freno - pianale inox mm 540x1042 completo di barriera portabottiglie - 2 piani d'appoggio inferiori in legno - vano porta bombole con sportello di chiusura - gruppo gas/bruciatore/accenditore - dispositivo di accensione piezoelettrico - funzionamento a gas liquido butano in bombola ricaricabile da kg 2,75 (autonomia 20 ore circa) oppure da kg 1,8 - bombola NON fornita.



**Standard gueridon trolley**

Carrello gueridon, standard  
Gueridonwagen, Standard  
Chariot gueridon, standard  
Carro gueridon estándar

art.	dim. cm.	Kg.	color	col.
18886-00	77,5x51x74,5	14,5	rosewood	●
18886M00	77,5x51x74,5	14,5	mahogany	●
18886N00	77,5x51x74,5	14,5	walnut	●
18886R00	77,5x51x74,5	14,5	oak	●

**4 swivel casters without brakes. Upon request, the trolley can be supplied equipped with intermediate shelf.** – 4 ruote pivotanti, senza freno. Su richiesta è possibile fornire il carrello dotato di piano intermedio.



**De luxe gueridon trolley**

Carrello gueridon, de luxe  
Gueridonwagen, Luxus-Ausführung  
Chariot gueridon, de luxe  
Carro gueridon, de luxe

art.	dim. cm.	Kg.	color	col.
18887-00	77,5x51x74,5	16,5	rosewood	●
18887M00	77,5x51x74,5	16,5	mahogany	●
18887N00	77,5x51x74,5	16,5	walnut	●
18887R00	77,5x51x74,5	16,5	oak	●

**4 swivel casters without brakes - 6 compartments drawer - removable upper deck.** – 4 ruote pivotanti, senza freno - cassetteria a sei scomparti - piano d'appoggio estraibile.





**Flambé trolley, electric**

Carrello flambé, elettrico  
Flambierwagen, elektrisch  
Chariot à flamber, électrique  
Carro flambé, eléctrico

art.	dim. cm.	Kg.	V	W	color	col.
18876-01	122x58,5x89,5	44,5	230	2300	rosewood	●
18876M01	122x58,5x89,5	44,5	230	2300	mahogany	●
18876N01	122x58,5x89,5	44,5	230	2300	walnut	●
18876R01	122x58,5x89,5	44,5	230	2300	oak	●

**4 swivel casters, 2 with brakes – upper deck in 18-10 stainless steel mm 540x1042 with protection ring – 2 lower wooden decks - built-in electric heating unit, high-light, ø 32 cm, ceramic heating surface ø 26 cm - 1 built-in plug, backside - cable - adjustable heat control unit and 1 magneto termic switch. – 4 ruote pivotanti di cui 2 con freno - pianale inox mm 540x1042 completo di barriera perimetrale - 2 piani d'appoggio inferiori in legno - piastra elettrica high-light da incasso ø 32 cm, piano riscaldante in vetroceramica ø 26 cm - 1 spina ad incasso (posteriore carrello) - cavo di alimentazione - regolatore di energia ed interruttore magnetotermico.**



**Flambé trolley, 2 burners**

Carrello flambé, 2 fuochi  
Flambierwagen, 2 Brenner  
Chariot à flamber, 2 feux  
Carro flambé, 2 fuegos

art.	dim. cm.	Kg.	color	col.
18877-00	122x58,5x89,5	46,5	rosewood	●
18877M00	122x58,5x89,5	46,5	mahogany	●
18877N00	122x58,5x89,5	46,5	walnut	●
18877R00	122x58,5x89,5	46,5	oak	●

**4 swivel casters, 2 with brakes - upper deck in 18-10 stainless steel mm 540x1042 with protection ring - 2 lower wooden decks - cabinet for gas cylinder – 2 gas/burning/lighting units - piezoelectric lighting device - operating with liquid butan gas, 2,75 kg rechargeable cylinder (lasting for 20 hours about) or 1,8 kg cylinder - trolley supplied without cylinder.**

4 ruote pivotanti di cui 2 con freno - pianale inox mm 540x1042 completo di barriera perimetrale – 2 piani d'appoggio inferiori in legno - vano porta bombole con sportello di chiusura- 2 gruppi gas/bruciatore/accenditore - dispositivo di accensione piezoelettrico - funzionamento a gas liquido butano in bombola ricaricabile da kg 2,75 (autonomia 20 ore circa) oppure da kg 1,8 - bombola NON fornita.



**Mini flambé trolley**

Carrello mini-flambé  
Flambierwagen, Mini-Ausführung  
Chariot à flamber, mini  
Mini carro flambé

art.	dim. cm.	Kg.	color	col.
18875-00	77,5x51x74,5	22	rosewood	●
18875M00	77,5x51x74,5	22	mahogany	●
18875N00	77,5x51x74,5	22	walnut	●
18875R00	77,5x51x74,5	22	oak	●

**4 swivel casters without brakes - upper deck in 18-10 stainless steel, satin finishing - lower deck with bottle holder. – 4 ruote pivotanti, senza freno - piano superiore in acciaio inox 18-10, satinato - vano inferiore con portabottiglie.**



**Hors d'oeuvre trolley**

Carrello antipasti  
Vorspeisewagen  
Chariot à hors d'oeuvres  
Carro entremeses

art.	dim. cm.	Kg.	color	col.
18878-00	122x62x106	38	rosewood	●
18878M00	122x62x106	38	mahogany	●
18878N00	122x62x106	38	walnut	●
18878R00	122x62x106	38	oak	●

**4 swivel casters, 2 with brakes – methacrylate revolving cloche – hors d'oeuvre inserts carrying deck in 18-10 s/s with protection ring - 9 hors d'oeuvre glass inserts, mm 123x203. Upon request, the trolley can be supplied equipped with intermediate shelf. – 4 ruote pivotanti, 2 con freno - cupola in metacrilato con apertura a scomparsa - piano porta-vaschette antipasti in acciaio inox 18-10 con barriera perimetrale - 9 vaschette antipasti in vetro, dim. mm 123 x 203. Su richiesta è possibile fornire il carrello dotato di piano intermedio.**



#### Cooled hors d'oeuvre trolley

Carrello antipasti, refrigerato  
Vorspeisewagen, gekühlt  
Chariot à hors d'oeuvres, réfrigéré  
Carro entremeses, refrigerado

art.	dim. cm.	Kg.	color	col.
18879-00	122x62x106	38	rosewood	●
18879M00	122x62x106	38	mahogany	●
18879N00	122x62x106	38	walnut	●
18879R00	122x62x106	38	oak	●

**4 swivel casters, 2 with brakes - methacrylate revolving cloche - eutectic pads container with 18-10 stainless steel cover - 8 eutectic pads 2,2 lbs each, mm 170x200 - 9 hors d'oeuvre glass inserts, mm 123x203. Upon request, the trolley can be supplied equipped with intermediate shelf. - 4 ruote pivotanti di cui 2 con freno - cupola in metacrilato, con apertura a scomparsa - copertura vasca per contenitori eutettici in acciaio inox 18-10 - 8 contenitori eutettici da kg 1 cadauno, dim. mm 170 x 200 - 9 vaschette antipasti in vetro, dim. mm 123 x 203. Su richiesta è possibile fornire il carrello dotato di piano intermedio.**



#### Patisserie trolley

Carrello pasticceria Omicron  
Kuchen-/Nachspeisewagen  
Chariot à pâtisserie  
Carro postres

art.	dim. cm.	Kg.	color	col.
18880-00	113x56,5x104	57	rosewood	●
18880M00	113x56,5x104	57	mahogany	●
18880N00	113x56,5x104	57	walnut	●
18880R00	113x56,5x104	57	oak	●

**Methacrylate revolving cloche, bifrontal rotation - 4 swivel casters, 2 with brakes - 1 upper fixed deck in metacrilat mm 200x750 - 1 upper removable deck in metacrilat mm 400x750 - 2 revolving plate racks in 18-10 stainless steel - 2 lower wooden decks. - Cupola tonda in metacrilato, montata su guide laterali, che ne permettono la rotazione nei due sensi - 4 ruote pivotanti di cui 2 con freno - 1 piano fisso in metacrilato mm 200x750 - 1 piano mobile in metacrilato mm 400x750 - 2 portapiatti ribaltabili in acciaio inox 18-10 - 2 piani d'appoggio inferiori in legno.**



#### Cake and cheese trolley

Carrello dolci-formaggi  
Dessert-/Käsewagen  
Chariot à fromages et desserts  
Carro postres/quesos

art.	dim. cm.	Kg.	color	col.
18882-00	122x62x106	38	rosewood	●
18882M00	122x62x106	38	mahogany	●
18882N00	122x62x106	38	walnut	●
18882R00	122x62x106	38	oak	●

**4 swivel casters, 2 with brakes - methacrylate revolving cloche - beech texwood cutting board mm 728x424 - revolving plate rack in 18-10 stainless steel. Upon request, the trolley can be supplied equipped with intermediate shelf. - 4 ruote pivotanti di cui 2 con freno - cupola in metacrilato, con apertura a scomparsa - tagliere in texwood faggio naturale mm 728 x 424 - portapiatti ribaltabile in acciaio inox 18-10. Su richiesta è possibile fornire il carrello dotato di piano intermedio.**



#### Cooled cake trolley

Carrello dolci, refrigerato  
Dessertwagen, gekühlt  
Chariot à desserts, réfrigéré  
Carro postres, refrigerado

art.	dim. cm.	Kg.	color	col.
18884-00	122x62x106	47,5	rosewood	●
18884M00	122x62x106	47,5	mahogany	●
18884N00	122x62x106	47,5	walnut	●
18884R00	122x62x106	47,5	oak	●

**4 swivel casters, 2 with brakes - metacrilat revolving cloche - eutectic pads container with 18-10 stainless steel cover - 8 eutectic pads 2,2 lbs each, mm 170x200 - revolving plate rack in 18-10 stainless steel. Upon request, the trolley can be supplied equipped with intermediate shelf. - 4 ruote pivotanti di cui 2 con freno - cupola in metacrilato, con apertura a scomparsa - vaschetta porta contenitori eutettici con copertura in acciaio inox 18-10 - 8 contenitori eutettici da kg 1 cadauno, mm 170x200 - portapiatti ribaltabile in acciaio inox 18-10. Su richiesta è possibile fornire il carrello dotato di piano intermedio.**





**Cooled mini cheese trolley**

Carrello mini-formaggi, refrigerato  
Käsewagen, gekühlt, Mini-Ausführung  
Chariot à fromages, réfrigéré, mini  
Mini carro quesos, refrigerado

art.	dim. cm.	Kg.	color	col.
18895-00	77,5x51x94	16,5	rosewood	●
18895M00	77,5x51x94	16,5	mahogany	●
18895N00	77,5x51x94	16,5	walnut	●
18895R00	77,5x51x94	16,5	oak	●

**4 swivel casters without brakes - metacrilat roll-top cover, opening at 90° - eutectic pads container with stainless steel cover (eutectic pads incl.) - 1 removable cutting board, GN 1/1 - revolving plate rack in stainless steel.**  
4 ruote pivotanti senza freno - cupola in metacrilato, con apertura a 90° - vaschetta porta contenitori eutettici (eutettici inclusi) con copertura in acciaio inox - 1 tagliere mobile, GN 1/1 - portapiatti ribaltabile in acciaio inox.



**Wine trolley**

Carrello vini  
Weinwagen  
Chariot à vins  
Carro de vinos

art.	dim. cm.	Kg.	color	col.
18897-00	122x62x92	39	rosewood	●
18897M00	122x62x92	39	mahogany	●
18897N00	122x62x92	39	walnut	●
18897R00	122x62x92	39	oak	●

**4 swivel casters, 2 with brakes - upper deck with stainless steel bottle holder ring - bottle caps and wine card compartment - 6 compartments for bottle coolers (bottle coolers included) - glass rack, deck downside - lower deck with bottle rack, 12 compartments. - 4 ruote pivotanti di cui 2 con freno - barriera porta bottiglie in acciaio inox - contenitore per tappi e carta vini - vano con 6 glacette (glacette incluse) - rastrelliera porta bicchieri, sotto piano carrello - piano inferiore con rastrelliera porta bottiglie, 12 posti.**



**Liqueur trolley**

Carrello liquori  
Aperitif-/Digestivwagen  
Chariot à liqueurs  
Carro licores

art.	dim. cm.	Kg.	color	col.
18889-00	124x68,5x104	37	rosewood	●
18889M00	124x68,5x104	37	mahogany	●
18889N00	124x68,5x104	37	walnut	●
18889R00	124x68,5x104	37	oak	●

**4 swivel casters, 2 with brakes - bottle holder protection ring in 18-10 stainless steel. - 4 ruote pivotanti di cui 2 con freno - barriera portabottiglie in acciaio inox 18-10.**



**Serving trolley**

Carrello servizio  
Servierwagen  
Chariot à servir  
Carro de servicio

art.	dim. cm.	Kg.	color	col.
18891-00	122x58,5x89,5	35,5	rosewood	●
18891M00	122x58,5x89,5	35,5	mahogany	●
18891N00	122x58,5x89,5	35,5	walnut	●
18891R00	122x58,5x89,5	35,5	oak	●

**4 swivel casters, 2 with brakes - removable upper deck and wooden drawer. Upon request, the trolley can be supplied equipped with intermediate shelf. 4 ruote pivotanti di cui 2 con freno - piano estraibile e cassetto in legno. Su richiesta è possibile fornire il carrello dotato di piano intermedio.**





**Sherbet/ice cream trolley**

Carrello sorbetti  
Sorbetwagen  
Chariot à sorbets/glacés  
Carro sorbetes

art.	dim. cm.	Kg.	color	col.
18893-00	122x62x93	43	rosewood	●
18893M00	122x62x93	43	mahogany	●
18893N00	122x62x93	43	walnut	●
18893R00	122x62x93	43	oak	●

**4 swivel casters, 2 with brakes - 4 18-10 stainless steel insulated sherbet holders (lt 1,2 each) - flatware drawer - revolving plate rack and ice cream scoops holder in stainless steel.** – 4 ruote pivotanti di cui 2 con freno - 4 sorbettiere termiche in acciaio inox 18-10 da lt 1,2 cadauna - cassetto portaposate - portapiatti ribaltabile e portapalette-gelato in acciaio inox 18-10.



**Round trolley**

Carrello tondo  
Servierwagen, rund  
Chariot rond  
Carro redondo

art.	Ø cm.	h. cm.	Kg.	color	col.
18888-00	60	89,5	23	rosewood	●
18888M00	60	89,5	23	mahogany	●
18888N00	60	89,5	23	walnut	●
18888R00	60	89,5	23	oak	●

**4 swivel casters without brakes – removable upper deck - perimeter barrier.**  
4 ruote pivotanti, senza freno - piano d'appoggio laterale estraibile - barriera perimetrale.



PP

**Serving trolley**

Carrello servizio  
Servierwagen  
Chariot à servir  
Carro de servicio

art.	dim. cm.	col.
49995-04	97x51x99	●

**Swivel casters for easy manoeuvrability. Ergonomic handles, high load capacity 135 kg (45 kg per shelf). Ultra-quiet mark-resistant casters.**  
Maniglie ergonomiche arrotondate, pannelli laterali e bordo paraurti arrotondato. Portata 135 kg (45 kg per ripiano). Ruote girevoli, antirattacchia e silenziose.



W

**Breakfast tray with legs**

Vassoio colazione con gambe  
Frühstückstablett mit Beinen  
Plateau petit déjeuner avec jambes  
Bandeja desayuno con patas

art.	dim. cm.	col.
19902-38	58,5x38,5x30	●

Wenge. – Wengè



W

**Room service tray**

Vassoio room service  
Zimmerservice-Tablett  
Plateau room-service  
Bandeja room service

art.	dim. cm.	col.
19901-35	52x35	●
19901-40	60x40	●
19901-47	71x47	●

Dark walnut. – Noce scuro.



2-tier service trolleys with hygienic plexiglas dome cover double side opening and 4 standard swivel wheels, 2 with brake. A new way of serving food safely and fighting COVID 19 by clearly dividing the kitchen side and the service side to avoid contamination and have the most hygienic service possible.

Carrelli di servizio a 2 piani dotati di cupola igienica in plexiglas apribile sui 2 lati e 4 ruote girevoli di cui 2 con freno. Un nuovo modo di servire gli alimenti in sicurezza e combattere COVID 19 dividendo chiaramente il lato cucina e il lato servizio per evitare contaminazioni e avere il servizio più igienico possibile.



**Serving trolley**

Carrello servizio  
Servierwagen  
Chariot à servir  
Carro de servicio

art. dim. cm.  
49996-00 89x47x103

Chromed structure, shelves elm color, perimeter barrier lower deck, sliding plate shelf upper deck, wheels Ø 100 mm. – Struttura cromata, ripiani color olmo, spondine di contenimento piano inferiore, pianetto estraibile, ruote Ø 100 mm.



**Serving trolley**

Carrello servizio  
Servierwagen  
Chariot à servir  
Carro de servicio

art. dim. cm.  
49996-01 89x47x103

Chromed structure, shelves elm color, wheels Ø 100 mm. Struttura cromata, ripiani color olmo, ruote Ø 100 mm.



**Serving trolley**

Carrello servizio  
Servierwagen  
Chariot à servir  
Carro de servicio

art. dim. cm.  
49996-05 89x47x103

Painted structure, shelves grey color, wheels Ø 100 mm. Struttura verniciata, ripiani colore grigio, ruote Ø 100 mm.





A range of service tables and trolleys designed to allow guests to comfortably and safely receive and consume breakfast or dinner in their room. Hot boxes made of AISI 304 stainless steel with double insulated wall. Analogic thermostat 30-90°C with indicator light. Equipped with two inner height-adjustable grids. Suitable for dishes up to Ø 32 cm. Refrigerated boxes made of AISI 304 stainless steel with double insulated wall with chilling pack -32°C inserted in a condensate collector basket placed on the upper grid. Chill for about 5 hours. Room service tables: chromes tube structure, 2 castors with brake. Top Ø 90 cm made of CDF (Compact Density Fibreboard). Can carry up to 2 boxes.

Una gamma di tavoli e carrelli per il servizio in camera per permettere agli ospiti di ricevere e consumare comodamente e in piena sicurezza la colazione o la cena in stanza. Box termici in acciaio inox AISI 304 a doppia parete coibentata. Termostato analogico 30-90°C con spia luminosa di funzionamento. Forniti con due griglie interne regolabili in altezza. Idonei per piatti fino a Ø 32 cm. Box refrigerati in acciaio inox AISI 304 a doppia parete coibentata. Refrigerazione a mezzo di una piastra eutettica -32°C inserita in un cesto di raccolta posizionato sulla griglia superiore. Raffreddare per c.ca 5 ore. Tavolini: struttura in tubo cromato, 2 ruote con freno. Piano Ø 90 cm in CDF (Compact Density Fibreboard). Possono trasportare fino a 2 box.



**Thermic hot box**

Box termico  
Speisen-Kaste  
Caisson thermique  
Cajón térmico

art.	dim. cm.	W
44094-00	38x40,5x51,2	500

**Refrigerated box**

Box refrigerato  
Speisen-Kaste  
Caisson réfrigéré  
Cajón refrigerado

art.	dim. cm.
44094R00	38x40,5x51



**Room service table**

Tavolino room service  
Zimmerservice-Tisch  
Table de restauration en chambre  
Carrito de servicio de habitaciones

art.	Ø cm.	h. cm.
44094-01	90/54,6	77



**Room service table with hot box**

Tavolino room service con hot box  
Zimmerservice-Tisch mit Hot Box  
Table de restauration en chambre avec hot box  
Carrito de servicio de habitaciones con hot box

art.	Ø cm.	h. cm.	W
44094-02	90/54,6	77	500

**44094-00 + 44094-01.**

With fold down flaps for easy crossing of doors and lifts.  
Con flaps pieghevoli per attraversare porte e ascensori.

**ROOM SERVICE**



**Room service table**

Tavolino room service  
Zimmerservice-Tisch  
Table de restauration en chambre  
Carrito de servicio de habitaciones

art. Ø cm. h. cm. closed/chiuso  
44094-03 90/54,6 78,6 74x54x117

**With fold down flaps for easy crossing of doors and lifts. With capsizable top for stacking when not in use.** – Con flaps pieghevoli per attraversare porte e ascensori. Ribaltabile e impilabile quando non in uso.



**Room service table with hot box**

Tavolino room service con hot box  
Zimmerservice-Tisch mit Hot Box  
Table de restauration en chambre avec hot box  
Carrito de servicio de habitaciones con hot box

art. Ø cm. h. cm. W  
44094-04 90/54,6 78,6 500

**44094-00 + 44094-03.**



**Room service table**

Tavolino room service  
Zimmerservice-Tisch  
Table de restauration en chambre  
Carrito de servicio de habitaciones

art. Ø cm. h. cm. closed/chiuso  
44094-05 90/73 76 73x33x98

**With fold down flaps for easy crossing of doors and lifts. Foldable for saving space when not in use.** – Con flaps pieghevoli per attraversare porte e ascensori. Pieghevole per ridurre l'ingombro quando non in uso.



**Room service table with hot box**

Tavolino room service con hot box  
Zimmerservice-Tisch mit Hot Box  
Table de restauration en chambre avec hot box  
Carrito de servicio de habitaciones con hot box

art. Ø cm. h. cm. W  
44094-06 90/73 76 500

**44094-00 + 44094-05.**



**Serving trolley**

Carrello servizio  
Servierwagen  
Chariot à servir  
Carro de servicio

art. des. dim. cm.  
49996-01 trolley 89x47x103  
44094-00 hot box 38x40,5x51,2  
44094R00 cold box 38x40,5x51

**With hygienic plexiglas dome cover double side opening. The trolley can be equipped with 2 hot and/or cold boxes. Ideal for maintaining the temperature of food and for the room service.** – Cupola igienica in plexiglas apribile sui 2 lati. Il carrello è equipaggiabile con 2 box termici caldi e/o freddi. Ideale per mantenere la temperatura delle portate e per il servizio in camera.



**Serving trolley**

Carrello servizio  
Servierwagen  
Chariot à servir  
Carro de servicio

art. des. dim. cm.  
49996-05 trolley 89x47x103  
44094-00 hot box 38x40,5x51,2  
44094R00 cold box 38x40,5x51

**With hygienic plexiglas dome cover double side opening. The trolley can be equipped with 2 hot and/or cold boxes. Ideal for maintaining the temperature of food and for the room service.** – Con cupola igienica in plexiglas apribile sui 2 lati. Il carrello è equipaggiabile con 2 box termici caldi e/o freddi. Ideale per mantenere la temperatura delle portate e per il servizio in camera.



# SERIES 14000

STORAGE & TRANSPORT  
STOCCAGGIO E TRASPORTO



Molded in one-piece with double-wall construction made of polypropylene. Resistant to shock, high temperatures and chemicals. Designed to give optimum protection to glass and chinaware as well as to maximise water circulation and drying in professional dishwasher. Easy and quickly stackable without tools or screws. Base racks have comfortable hand grips on all four sides facilitating handling.

Realizzati in polipropilene, stampati unipezzo a doppio spessore. Resistenti agli urti ed alte temperature, agenti chimici e residui alimentari. Concepiti per assicurare una protezione ottimale a bicchieri e stoviglie, il loro design permette inoltre una perfetta circolazione dell'acqua di lavaggio ed una rapida e perfetta asciugatura. Facili e veloci da impilare. Leggeri e maneggevoli, tutti i cestelli di base sono dotati di maniglie integrali su tutti i lati.





**9-Compartment base**

Cestello 9 bicchieri  
Grundkorb für 9 Gläser  
Panier de base 9 verres  
Cesta 9 compartimentos

art. mm.  
14001-09 500x500x103

**Compartments / Scosparti 151x151x42 mm.  
ø max 151 mm.**



**9-Compartment extender**

Estensore per cestello 9 bicchieri  
Aufsatz zum Grundkorb für 9 Gläser  
Réhausse pour panier de base 9 verres  
Extensión 9 compartimentos

art. mm.  
14003-09 500x500x45

**Compartments / Scosparti 151x151x88 mm.  
ø max 151 mm.**



**16-Compartment base**

Cestello 16 bicchieri  
Grundkorb für 16 Gläser  
Panier de base 16 verres  
Cesta 16 compartimentos

art. mm.  
14001-16 500x500x103

**Compartments / Scosparti 112x112x88 mm.  
ø max 112 mm.**



**16-Compartment extender**

Estensore per cestello 16 bicchieri  
Aufsatz zum Grundkorb für 16 Gläser  
Réhausse pour panier de base 16 verres  
Extensión 16 compartimentos

art. mm.  
14003-16 500x500x45

**Compartments / Scosparti 112x112x42 mm.  
ø max 112 mm.**



**25-Compartment base**

Cestello 25 bicchieri  
Grundkorb für 25 Gläser  
Panier de base 25 verres  
Cesta 25 compartimentos

art. mm.  
14001-25 500x500x103

**Compartments / Scosparti 88x88x88 mm.  
ø max 88 mm.**



**25-Compartment extender**

Estensore per cestello 25 bicchieri  
Aufsatz zum Grundkorb für 25 Gläser  
Réhausse pour panier de base 25 verres  
Extensión 25 compartimentos

art. mm.  
14003-25 500x500x45

**Compartments / Scosparti 88x88x42 mm.  
ø max 88 mm.**



**36-Compartment base**

Cestello 36 bicchieri  
Grundkorb für 36 Gläser  
Panier de base 36 verres  
Cesta 36 compartimentos

art. mm.  
14001-36 500x500x103

**Compartments / Scosparti 73x73x88 mm.  
ø max 73 mm.**



**36-Compartment extender**

Estensore per cestello 36 bicchieri  
Aufsatz zum Grundkorb für 36 Gläser  
Réhausse pour panier de base 36 verres  
Extensión 36 compartimentos

art. mm.  
14003-36 500x500x45

**Compartments / Scosparti 73x73x42 mm.  
ø max 73 mm.**



**49-Compartment base**

Cestello 49 bicchieri  
Grundkorb für 49 Gläser  
Panier de base 49 verres  
Cesta 49 compartimentos

art. mm.  
14001-49 500x500x103

**Compartments / Scosparti 62x62x42 mm.  
ø max 62 mm.**



**49-Compartment extender**  
 Estensore per cestello 49 bicchieri  
 Aufsatz zum Grundkorb für 49 Gläser  
 Réhausse pour panier de base 49 verres  
 Extensión 49 compartimentos

art. mm.  
 14003-49 500x500x45

**Compartments / Scomparti 62x62x42 mm.  
 ø max 62 mm.**



**Open extender**  
 Estensore aperto  
 Universalrand ohne Einteilung  
 Réhausse sans cloisons  
 Extensión abierta

art. mm.  
 14004-00 500x500x42



**Rack cover**  
 Coperchio per cestelli  
 Deckel für Körbe  
 Couvercle à panier  
 Tapa para cestas

art. mm.  
 14011-00 505x505x25



**Open rack**  
 Cestello universale  
 Universal-Korb  
 Panier universel  
 Cesta universal

art. mm.  
 14010-00 500x500x103



**Cutlery rack**  
 Cestello per posate  
 Besteckkorb  
 Panier à couverts  
 Cesta para cubiertos

art. mm.  
 14006-00 500x500x103



**Plates & trays rack**  
 Cestello per piatti e vassoi  
 Tablett- u. Tellerkorb mit Fingern  
 Panier à plateaux et assiettes  
 Cesta para bandejas y platos

art. mm.  
 14008-00 500x500x103

**For 18 flat plates or 9 trays max. 460 mm.**  
 Per 18 piatti piani oppure 9 vassoi max. 460 mm.



**Tray rack, open**  
 Cestello per vassoi, aperto  
 Tablettkorb mit Fingern, offen  
 Panier à plateaux, ouvert  
 Cesta abierto para bandejas

art. mm.  
 14007-00 500x500x103

**For trays over 460 mm. Capacity 9 pcs.**  
 Per vassoi oltre 460 mm. Cap. 9 pz.



**Clip tags, 10-pcs set**  
 Etichette di identificazione, set 10 pz  
 Markierungsklipp, 10 Stk.  
 Clips, set 10 pièces  
 Etiquetas, set 10 piezas

art. mm.  
 14013-00 80x40



**Cutlery holder 8 compartments**  
 Cestello per posate 8 scomparti  
 Besteckkorb, 8 Unterteilungen  
 Panier à couverts 8 compartiments  
 Cesta para cubiertos

art. mm.  
 14015-08 426x206x150

**For 200/250 pcs cutlery. – Per 200/250 posate.**





SS

**Cutlery dispenser**

Porta posate  
Besteckbehälter  
Récipient à couverts  
Contenedor para cubiertos

art.	cm.
42587-04	26x30x20



SS

**Cutlery holder**

Cestello porta posate  
Besteckbehälter  
Récipient à couverts  
Cestillo para cubiertos

art.	Ø cm.	h. cm.
42586-10	10	14



PE

**Cutlery holder**

Cestello porta posate  
Besteckbehälter  
Récipient à couverts  
Cestillo para cubiertos

art.	Ø cm.	h. cm.
42586-09	9,5	13,5



PP

**Cutlery dispenser**

Porta posate  
Besteckbehälter  
Récipient à couverts  
Contenedor para cubiertos

art.	cm.
42585-06	54x33x13



PE

**Cutlery dispenser**

Porta posate  
Besteckbehälter  
Récipient à couverts  
Contenedor para cubiertos

art.	cm.	GN	h. cm.
42585-04	32,5x53	1/1	10



PP

**Cutlery box lid**

Coperchio per porta posate  
Deckel für Besteckbehälter  
Couvercle pour récipient à couverts  
Tapa para contenedor cubiertos

art.	cm.
42585-00	32,5x53x2



**Dolly with handle**

Carrello con maniglione  
Transportwagen mit Griff  
Chariot avec poignée  
Carretilla con manillar

art.	cm.	Kg.
44023-00	54x54x75	10



**Dolly without handle**

Carrello senza maniglione  
Transportwagen ohne Griff  
Chariot sans poignée  
Carretilla sin manillar

art.	cm.	Kg.
44024-00	54x54	8,5



**Dolly, aluminum/ABS**

Carrello, alluminio/ABS  
Transportwagen, Aluminium/ABS  
Chariot, aluminium/ABS  
Carro, aluminio/ABS

art.	cm.
44975C50	51x51

Polypropylene base. – Base in PP.

Polypropylene base. – Base in PP.





SS

**Dolly with handle**  
 Carrello con maniglione  
 Transportwagen mit Griff  
 Chariot avec poignée  
 Carretilla con manillar

art. cm.  
 44025-50 55x55x9

**Removable handle, with drip and drain plug. Load 60 kg.** – Manico estraibile, tappo di scarico. Carico 60 kg.



**Dust cover**  
 Copertura protettiva  
 Schutzhülle  
 Housse de protection  
 Cuberta protectora

art. cm.  
 44009-00 55x55x122



SS

**Trolley 3 levels**  
 Carrello 3 livelli  
 3-stöckiger Wagen  
 Chariot à 3 étages  
 Carro 3 pisos

art. cm.  
 44020-21 100x50x178,5

**Suitable for 24 racks.**  
 Carico verticale per 24 cestelli.



PP

**Multipurpose box**  
 Recipiente  
 Behälter  
 Conteneur multiservice  
 Contenedor

art. cm.  
 44031-04 52x39x12,7  
 44031-05 52x39x17,7

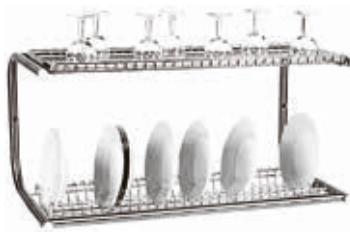

SS

**Wall draining rack**  
 Scolapiatti a muro  
 Wand-Trockengestell  
 Egouttoir au mur  
 Escurridor mural de platos

art. cm.  
 44029-00 87x30x20

**Load/Carico: 70 kg.**



**Wire dish rack**  
 Porta piatti in filo metallo/rilsan  
 Tellergerüst  
 Porte-assiettes

**Porta platos**

art.	Ø cm.	h. cm.
44047-17	17	30
44047-19	19	30
44047-22	22	30
44047-25	25	30
44047-28	28	30



SS

**Dish dolly**  
 Carrello portapiatti  
 Teller-Transportwagen  
 Chariot porte-assiettes  
 Carro porta platos

art. cm.  
 44027-00 74x61x81

**Load/Carico max: 240 kg.**



PE

**Adjustable dish dolly**  
 Carrello portapiatti regolabile  
 Teller-Transportwagen, einstellbar  
 Chariot de stockage d'assiettes réglable  
 Carro ajustable para platos

art.  
 49304-06

**With dust cover and 4 dividers. Dishes Ø cm 16-32, capacity 180/400 pcs.** – Con copertura vinilica e 4 divisori. Per piatti Ø cm16-32, capienza 180/400 pz.

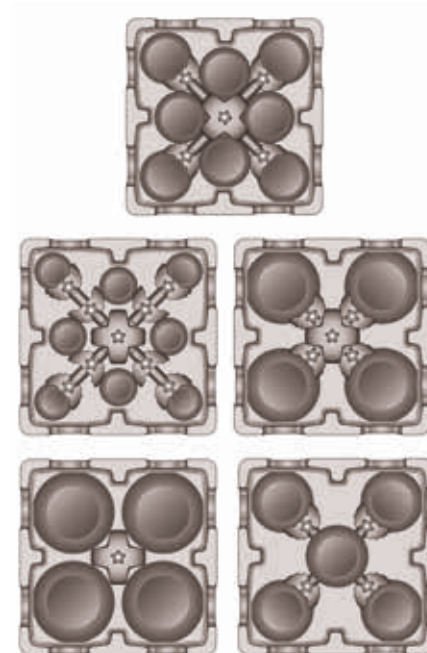

**CROCKERY TRANSPORT BOX**  
CONTENITORE PER IL TRASPORTO DI STOVIGLIE



Clear polypropylene construction, full compliance with food contact requirements. A removable tower insert provides total flexibility. Strong, it prevents dish breakage in transport. Dimensions suitable to EURO-pallets. Lids are tightly fitting, hygienic, dish-washer safe. Covers available in different colors, assure easy and quick content identification. Stackable once empty, their strongness provides high loading density once full. Ventilation holes assure constant air circulation. Design studied to enable water flow while washing.

Contenitori in polipropilene trasparente per alimenti. Estremamente resistenti alle sollecitazioni, offrono protezione sicura nel trasporto. Dimensioni adatte a EURO-pallets. Adatti al lavaggio in lavastoviglie, design studiato per consentire il defluire dell'acqua. Coperchi di colore diverso facilitano l'individuazione del contenuto. Impilabili, a pieno la loro robustezza consente un'elevata capacità di sovrapposizione. Fessure di aerazione per un costante ricambio d'aria.



**Storage box**

Contentore  
Korb  
Panier  
Contenedor

art.	cm.	lt.
44040-40	40x40x31,5	32



**Base insert**

Fondo piatto  
Flach-Einsatz  
Plateau double fond  
Base plana

art.	cm.
44042-00	40x40



**Cross insert**

Inserto croce  
Kreuz-Einsatz  
Cloison à croix  
Separador a cruz

art.	cm.
44043-00	40x40



**Cover**

Coperchio  
Deckel  
Couvercle  
Tapa

art.	col.
44041-00	○
44041-01	●
44041-03	●



**Cover**

Coperchio  
Deckel  
Couvercle  
Tapa

art.	col.
44041-04	●
44041-05	●



**Tower insert**

Tubo fermapiatti  
Rohr-Einsatz  
Tuyau  
Tubo

art.
44044-00

## SQUARE & ROUND CONTAINERS CONTENITORI QUADRATI & ROTONDI



**Space-saving SQUARE containers.** In transparent anti-breaking material to identify the contents. Graduated measurements: red for US sizes and blue for liters. Resistant handles. Drainage holes. They withstand temperatures between -40°C and 100°C. Lids with hermetic pressure closure and corner tab for easy removal.

**ROUND stackable containers.** Reinforced rims. Drainage holes. They withstand temperatures between -28°C and 65°C. Dishwasher safe. Tight-fitting lids with double barrier and opening flap in the corner. Writing area on the cover to specify date and content.

Contenitori QUADRATI salvaspazio. In materiale infrangibile, trasparente per identificare il contenuto. Misurazioni graduate: rosse per le misure USA e blu per i litri. Impugnature resistenti. Fori di drenaggio. Resistono a temperature comprese fra i -40°C e i 100°C. Coperchi a chiusura ermetica a pressione e linguetta per una rimozione agevole.

Contenitori ROTONDI impilabili. Bordi rinforzati. Fori di drenaggio. Resistono a temperature comprese fra i -28°C e i 65°C. Lavabili in lavastoviglie. I coperchi sono a chiusura ermetica con doppia barriera e linguetta di apertura nell'angolo. Consentono l'indicazione della data e del contenuto in un'apposita area di scrittura.



### Food container, copolyester

Contenitore per alimenti, copoliestere  
Vorratsdosen, Copoliéster  
Conteneur pour aliments, copolyester  
Contenedor para alimentos, copolyester

art.	cm.	lt.
44620-01	22x21x7	1,9
44620-02	22x21x12	3,8
44620-03	22x21x17,5	5,7
44620-04	22x21x22	7,6



### Food container, copolyester

Contenitore per alimenti, copoliestere  
Vorratsdosen, Copoliéster  
Conteneur pour aliments, copolyester  
Contenedor para alimentos, copolyester

art.	cm.	lt.
44620-05	29x27x19	11,4
44620-06	29x27x30	17,0
44620-07	29x27x36,5	20,8



PE

### Square lid

Coperchio quadrato  
Deckel, viereckig  
Couvercle carré  
Tapa cuadrada

art.	cm.
44620-14	22x21
44620-17	29x27



PP

### Food container

Contenitore per alimenti  
Vorratsdosen  
Conteneur pour aliments  
Contenedor para alimentos

art.	Ø cm.	h. cm.	lt.
44625-03	25	19,5	5,7
44625-04	25	27,0	7,6
44625-05	33	20,5	11,4
44625-06	33	30,0	17,0



PP

### Food container

Contenitore per alimenti  
Vorratsdosen  
Conteneur pour aliments  
Contenedor para alimentos

art.	Ø cm.	h. cm.	lt.
44625-07	33	35,5	20,8
44625-08*	33	35,5	20,8

\*With handle. – Con manico.



PE

### Round lid

Coperchio rotondo  
Deckel, rund  
Couvercle rond  
Tapa redonda

art.	Ø cm.	col.
44625-26	25	●
44625-34	33	●



PC

**Food container**

Contentore per alimenti  
Nahrungsmittel-Behälter  
Conteneur pour aliments  
Contenedor para alimentos

art.	cm.	lt.
49384-03	45,7x30x23	19,0
49384-04	45,7x66x9	19,0
49384-05	45,7x66x15	32,3
49384-06	45,7x66x23	47,0
49384-07	45,7x66x38	81,5



PC

**Drain tray**

Vasca di drenaggio  
Abtropf-Behälter  
Conteneur perforé  
Contenedor para colar

art.	cm.
49384-11	45,7x66x12



PC

**Lid**

Coperchio  
Deckel  
Couvercle  
Tapa

art.	cm.
49384-14	45,7x30
49384-15	45,7x66



PP

**Food container**

Contentore per alimenti  
Nahrungsmittel-Behälter  
Conteneur pour aliments  
Contenedor para alimentos

art.	cm.	lt.
49382-10	30x38x21,5	10,0
49382-23	60x49x43	23,5
49382-47	60x29x43	47,0



PP

**Storage container**

Carrello per derrate alimentari  
Fahrbares Nahrungsmittelbehälter  
Chariot mobile de stockage  
Contenedor para hortalizas

art.	cm.	lt.
49381-01	74x33,5x71	79,0
49381-02	75x39,5x71	97,5
49381-03	75,5x45,5x71	116



PE

**Container, round**

Contentore tondo  
Behälter, rund  
Conteneur, rond  
Contenedor redondo

art.	Ø cm.	h. cm.	lt.
49373-01	39,7	43,5	37,9
49373-02	49,5	58,1	75,7
49373-03	55,9	69,2	121,1
49373-04	67,3	83,8	208,2



PE

**Lid, round**

Coperchio tondo  
Deckel, rund  
Couvercle, rond  
Tapa redonda

art.	Ø cm.	h. cm.
49373-11	40,6	2,5
49373-12	50,5	3,2
49373-13	56,5	3,5
49373-14	67,9	5,1



PE

**Dolly**

Supporto mobile  
Wagen  
Chariot  
Soporte móvil

art.	Ø cm.	h. cm.
49373-90	46,4	17

**Load/Carico: 113,4 kg.**



SS

**Sink trolley**

Carrello vasca  
Obst/Gemüsewaschwagen  
Chariot à évier  
Carro-cuba lavado verduras

art.	cm.	lt.
44028-19	80x60x75	190

**Tub with tap, brushed finish. Stamped bottom watertight, without edges.** – Vasca con rubinetto, finitura spazzolata. Fondo stampato a tenuta stagna, privo di spigoli.



**Bread basket**

Cesta pane  
Brot-Korb  
Corbeille à pain  
Cesta pan

art.	cm.	lt.
44982-04	57x36x34	40
44982-06	66x45x35	60
44982-10	78x52x40	100

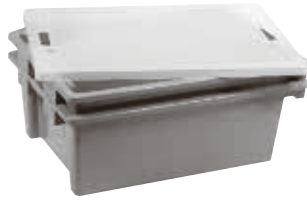

**Space saving box with cover**

Contenitore con coperchio  
Behälter mit Deckel  
Récipient avec couvercle  
Contenedor con tapa

art.	cm.
44033-23	66x45x23
44033-38	67x46x38



**Gastronorm basket**

Cesto gastronorm  
Gastronorm-Korb  
Panier gastronorme  
Cesta gastronorm

art.	cm.
44034-11	59x39x19,5

**STACKABLE CONTAINERS**  
CONTENITORI SOVRAPPONIBILI



**Stackable containers, external dimensions 600x400 mm and 400x300 mm, they perfectly fit to 800x1200 mm EUR pallets and to 1000x1200 mm. Available in different heights and versions. High density polyethylene HDPE. A thermoplastic that offers excellent impact resistance at low temperatures (from -30°C to +70°C).**

Contenitori sovrapponibili con dimensioni esterne di mm 600x400 e 400x300 perfettamente pallettizzabili su pallet EUR mm 800x1200 e 1000x1200. Disponibili in diverse altezze e versioni. Polietilene alta densità HDPE. Uno dei materiali termoplastici più dotato di resistenza all'impatto con basse temperature (da -30°C a +70°C).



**Container**

Contenitore  
Behälter  
Conteneur  
Contenedor

art.	cm.	lt.
44511E21	60x40x10	21
44511E63	60x40x32	63
44511E90	60x40x45	90

**Solid bottom and sides. – Fondo e pareti chiuse.**



**Container**

Contenitore  
Behälter  
Conteneur  
Contenedor

art.	cm.	lt.
44512E12	60x40x7	12
44512E21	60x40x10	21

**Solid bottom and perforated sides.**  
Fondo chiuso e pareti forate.



**Container**

Contenitore  
Behälter  
Conteneur  
Contenedor

art.	cm.	lt.
44513E12	60x40x7	12
44513E21	60x40x10	21

**Perforated bottom and sides.**  
Fondo e pareti forate.





PP

**Lid**  
Coperchio  
Deckel  
Couvercle

**Tapa**  
art. cm.  
41763-00 60x40x2



PP

**Lid**  
Coperchio  
Deckel  
Couvercle

**Tapa**  
art. cm.  
41763-30 40x30x2



**Container**  
Contentitore  
Behälter  
Conteneur  
Contenedor

art. cm. lt.  
44521E10 40x30x12 10

**Solid bottom and sides. – Fondo e pareti chiuse.**



**Container**  
Contentitore  
Behälter  
Conteneur  
Contenedor

art. cm. lt.  
44521-16 40x30x17 16  
44521-21 40x30x22 21  
44521-31 40x30x32 31

**Solid bottom and sides. – Fondo e pareti chiuse.**



**Container**  
Contentitore  
Behälter  
Conteneur  
Contenedor

art. cm. lt.  
44511-27 60x40x15 27  
44511-34 60x40x17 34  
44511-38 60x40x20 38  
44511-42 60x40x22 42  
44511-63 60x40x32 63  
44511-90 60x40x45 90

**Solid bottom and sides. – Fondo e pareti chiuse.**



**Container**  
Contentitore  
Behälter  
Conteneur  
Contenedor

art. cm. lt.  
44522E10 40x30x12 10

**Solid bottom and perforated sides.  
Fondo chiuso e pareti forate.**



**Container**  
Contentitore  
Behälter  
Conteneur  
Contenedor

art. cm. lt.  
44522-16 40x30x17 16  
44522-21 40x30x22 21  
44522-31 40x30x32 31

**Solid bottom and perforated sides.  
Fondo chiuso e pareti forate.**



**Container**  
Contentitore  
Behälter  
Conteneur  
Contenedor

art. cm. lt.  
44512-34 60x40x17 34  
44512-42 60x40x22 42  
44512-63 60x40x32 63  
44512-90 60x40x45 90

**Solid bottom and perforated sides.  
Fondo chiuso e pareti forate.**



**Container**  
Contentitore  
Behälter  
Conteneur  
Contenedor

art. cm. lt.  
44513-34 60x40x17 34  
44513-38 60x40x20 38  
44513-54 60x40x29 54  
44513-63 60x40x32 63  
44513-90 60x40x45 90

**Perforated bottom and sides.  
Fondo e pareti forate.**

## POLYPROPYLENE CONTAINERS CONTENITORI POLIPROPILENE



They do not hand over odours or flavours to foods. Easy to wash and disinfect after use. Light and free of protrusions and sharp edges. Resistant, hygienic, economic, 100% recyclable, suitable for industrial washing and disinfection with detergents and disinfectants, hot water, and wet vapour up to 110°C (HACCP System). Suitable to protect food thermal stresses.

Non cedono odori e sapori agli alimenti, facilmente lavabili e sanificabili. Leggeri e privi di sporgenze e spigoli vivi. Resistenti, igienici, ecologici e riciclabili al 100%. Compatibili al lavaggio e alla disinfezione industriale con detergenti e disinfectanti, acqua calda e vapore umido fino a 110°C (HAACCP System). Idonei a proteggere gli alimenti da sollecitazioni termiche.



### Insulated container POWERBOX

Contentitore isotermico  
Thermobehälter  
Conteneur isotherme  
Contenedor isotérmico

art.	cm.	lt.
44961-05	64,5x40x31,5	45



### Insulated container UNIVERSAL PN

Contentitore isotermico  
Thermobehälter  
Conteneur isotherme  
Contenedor isotérmico

art.	cm.	lt.
44986-12	61x43x20	24,0
44986-17	61x43x25	33,8
44986-21	61x43x29,5	42,8
44986-28	61x43x36,5	56,7



### Insulated container GN 1/2

Contentitore isotermico  
Thermobehälter  
Conteneur isotherme  
Contenedor isotérmico

art.	cm.	lt.
44972-20	41,5x32x28,5	20,3
44972-25	41,5x32x32	21,6
44972-33	41,5x32x40	31,2



### Insulated container GN 1/1

Contentitore isotermico  
Thermobehälter  
Conteneur isotherme  
Contenedor isotérmico

art.	cm.	lt.
44970-10	60x40x17	20,2
44970-15	60x40x23	31,2
44970-20	60x40x27	38,6
44970-34	60x40x34,5	52,3



### OPTIONAL 44970 -Sling & dolly

Imbragature e carrello  
Gurt und Wagen  
Sangle et chariot  
Correa y carro

art.	cm.
44987C62	62x42
44973-10	sling
44973-20	sling



### Insulated container PLUS GN 1/1

Contentitore isotermico  
Thermobehälter  
Conteneur isotherme  
Contenedor isotérmico

art.	cm.	lt.
44978-10	68x44,5x20	24,9
44978-20	68x44,5x30	45,6



### Insulated pastry container

Contentitore isotermico pasticceria  
Konditorei-Thermobehälter  
Conteneur isotherme à pâtisserie  
Contenedor isotérmico para pastelería

art.	cm.	lt.
44974-21	68,5x48,5x27	55,8
44974-27	68,5x48,5x33	71,7
44974-31	68,5x48,5x37	82,3



### Insulated container HANDTOP

Contentitore isotermico  
Thermobehälter  
Conteneur isotherme  
Contenedor isotérmico

art.	cm.	lt.
44961-06	71,5x40x31,5	45

**Incorporated ergonomic handles. For Gastronorm 1/1 or submultiples.** – Maniglie ergonomiche incorporate. Trasporta Gastronorm da 1/1 o sottomultipli.



### Insulated container TROLLEYBOX

Contentitore isotermico  
Thermobehälter  
Conteneur isotherme  
Contenedor isotérmico

art.	cm.	lt.
44961-04	42x42x60	60



**Insulated container BOXSHOP**

Contentitore isotermico  
Thermobehälter  
Conteneur isotherme  
Contenedor isotérmico

art.	cm.	lt.
44961-02	41,5x32x40	31,2



**Insulated container PIZZABOX**

Contentitore isotermico  
Thermobehälter  
Conteneur isotherme  
Contenedor isotérmico

art.	cm.	lt.
44961-03	42x42x34,5	36

**With steam release system.**

Con sistema di rilascio del vapore.



**Insulated container POPTER GN 1/1**

Contentitore isotermico  
Thermobehälter  
Conteneur isotherme  
Contenedor isotérmico

art.	cm.	lt.
44987-11	65x50x61	83

**For GN 1/1 or submultiples. 12 guides.**

Per GN 1/1 o sottomultipli. 12 guide.



**Insulated container PORTER MAXI**

Contentitore isotermico  
Thermobehälter  
Conteneur isotherme  
Contenedor isotérmico

art.	cm.	lt.
44987-60	72x60x63	128

**Guides/Guide: 9**



**Insulated container GN CRYSTAL**

Contentitore isotermico  
Thermobehälter  
Conteneur isotherme  
Contenedor isotérmico

art.	cm.	lt.
44968-00	60x40x30	45,4

**Inside crystallized and therefore perfectly smooth, rigid and waterproof.**

Interno cristallizzato perfettamente liscio, rigido e impermeabile.



**Dolly, aluminum/ABS**

Carrello, alluminio/ABS  
Fahrgestell, Aluminium/ABS  
Chariot, aluminium/ABS  
Carro, aluminio/ABS

art.	cm.	for/per
44975C50	58,5x58,5	44975-50
44987C11	68x52	44987-11
44987C60	75x61	44987-60
44987C62	62x42	44968-00



**Eutectic pad**

Accumulatore di freddo  
Kühlakku  
Cartouche eutectique  
Placa eutéctica

art.	cm.	GN
44979-04	32,5x26,5x3	1/2
44979-05	53x32,5x3	1/1
44979-06	60x40x3	-

**0/-21°C.**



**Heat accumulator**

Accumulatore di caldo  
Wärmespeicher  
Accumulateur de chaleur  
Acumulador de calor

art.	cm.	GN
44979-02	53x32,5x3	1/1

**0/+85°C.**



**Insulated box**

Box isotermico  
Thermobehälter  
Conteneur isotherme  
Contenedor individual isotérmico

art.	cm.
44976-04	44x38x12

**3 sections for dishes ø 12 h 6 cm or 16x16 cm.**

3 vani per piatti ø 12 h 6 cm o 16x16 cm.





**Insulated box DOMUS**

Box isothermico  
Thermobehälter  
Conteneur isotherme  
Contenedor individual isotérmico

art. cm.  
44976-02 42,5x26,5x16,5

**2 sections for dishes 18x18 cm.**  
2 vani per piatti 18x18 cm.



**Insulated box MONOKING**

Box isothermico  
Thermobehälter  
Conteneur isotherme  
Contenedor individual isotérmico

art. cm.  
44976-01 42,5x35x16

**2 insulated sections for dishes size 18x18 cm.**  
2 vani coibentati per piatti 18x18 cm.



**Insulated box THERMOKING**

Box isothermico  
Thermobehälter  
Conteneur isotherme  
Contenedor individual isotérmico

art. cm.  
44976-03 47x37x18,5

**Release latch lid. Usefull height 11,5 cm.**  
Coperchio a incastro. Altezza utile 11,5 cm.

**MODULAR SYSTEM**  
SISTEMA MODULARE

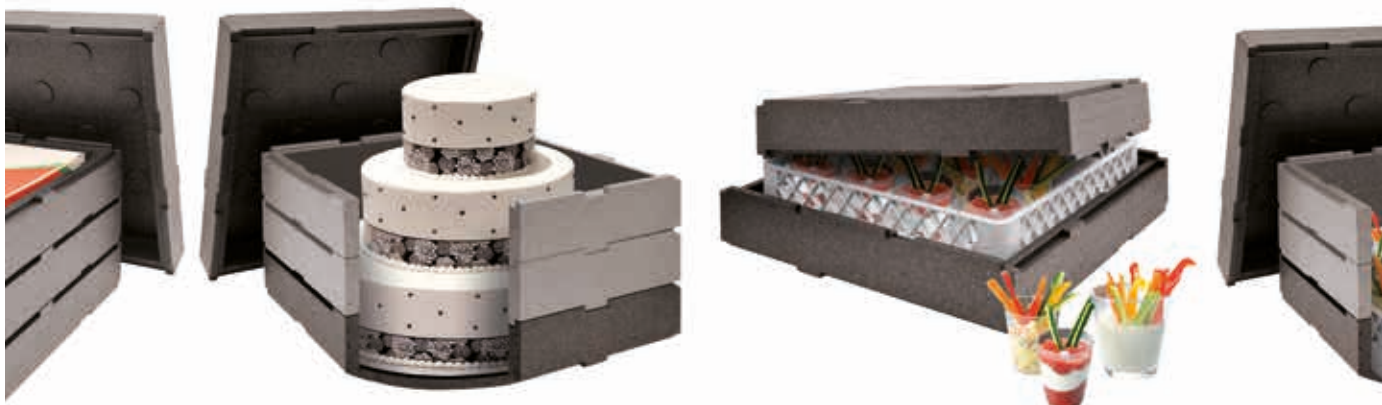

**Modular system, the base and lid are the same element and due to the extender insert it is possible to increase capacity. Equipped with rotation system that allows steam to escape.**

**Sistema modulare, base e coperchio sono lo stesso elemento e grazie all'inserto estensore è possibile aumentare la capacità. Provvisto di sistema rotabile, per la fuoriuscita del vapore.**



**Base and lid**

Base e coperchio  
Basis und Abdeckung  
Base et couvercle  
Base y tapa

art. cm. ext.  
44975-35 41x41x7,5  
44975-50 57x57x9,5



**Extender**

Estensore  
Aufsatz  
Réhausse  
Extensión

art. cm. ext.  
44975H35 41x41x7,5  
44975H50 57x57x9,5





SS

**Insulated container**  
Contentitore isotermico  
Thermobehälter  
Conteneur isotherme  
Contenedor isotérmico

art.	Ø cm.	h. cm.	lt.
44505-10	30	22,5	10
44505-15	36	21,5	15
44505-20	36	28,5	20
44505-25	36	35,0	25



SS

**Insulated container**  
Contentitore isotermico  
Thermobehälter  
Conteneur isotherme  
Contenedor isotérmico

art.	Ø cm.	h. cm.	lt.
44506-09	30	34	9

**Incl. cleaning brush and labels Milk, Coffee and Tea in 5 languages.** – Incl. scovolino, etichette Latte, Caffè e Tè in 5 lingue.



SS

**Food container**  
Pietanziera  
Speisenbehälter  
Porte-manger  
Contenedor comida

art.	Ø cm.	h. cm.
44977-12	12	6



**Insulated container GN 1/1**  
Contentitore isotermico GN 1/1  
Thermobehälter GN 1/1  
Conteneur isotherme GN 1/1  
Contenedor isotérmico GN 1/1

art.	cm.	lt.
44932-15	61x41x25	24,6
44932-20	61x41x30	31,1

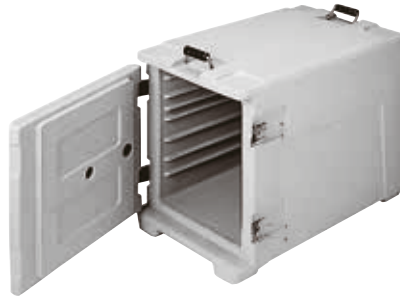

**Insulated container GN 1/1**  
Contentitore isotermico GN 1/1  
Thermobehälter GN 1/1  
Conteneur isotherme GN 1/1  
Contenedor isotérmico GN 1/1

art.	cm.	lt.
44934-30	44x64x48	63



**Insulated beverage dispenser**  
Distributore di bevande isotermico  
Isolierte Getränkebehälter  
Conteneur isotherme avec robinet  
Contenedor isotérmico con grifo

art.	cm.	lt.
44930-10	24x43x43	10
44930-20	30x46x46	20



PP

**Ice cart**  
Carrello porta ghiaccio  
Eiswagen  
Chariot à glace  
Carro hielo

art.	cm.
44936-57	72x57x85

**Load/Carico: 57 kg.**



PC

**Ice scoop with holder**  
Pala ghiaccio con supporto  
Eisschaufel mit Träger  
Pelle à glace avec support  
Librador hielo con soporte

art.	cm.	lt.
44936-02	30,7x20,3x19	2



PC

**Ice bucket**  
Secchio ghiaccio  
Eiseimer  
Seau à glace  
Cubo hielo

art.	cm.	lt.
44936-20	34x31x45	20,8

## JACKSTACK

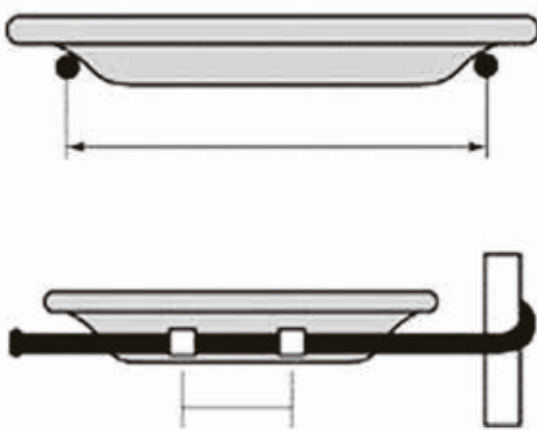

**Welded steel construction. Black electrostatic powder coating. Quick set assembly in minutes. Quick-change to any plate size (max ø cm 30, kg 3 each). Length of plate support 17 cm, spacing 5 cm.**

Struttura in acciaio saldato. Rivestimento nero elettrostatico. Assemblaggio veloce. Adattabile ad ogni misura di piatto (ø max cm 30, kg 3). Lunghezza bracci 17 cm, distanza 5 cm.



**Mobile plate rack**  
Carrello porta piatti  
Fahrbares Tellergerüst  
Chariot porte-assiettes mobile  
Carrito para almacenaje de platos

art. cm.  
44830-99 60x60X179

**For pcs/Per pz 104**

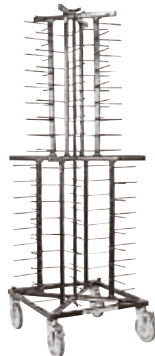

**Mobile plate rack**  
Carrello porta piatti  
Fahrbares Tellergerüst  
Chariot porte-assiettes mobile  
Carrito para almacenaje de platos

art. cm.  
44830-72 60x60X180

**For pcs/Per pz 72**

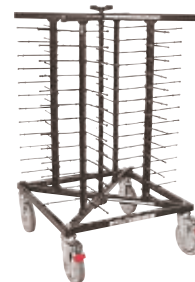

**Mobile plate rack**  
Carrello porta piatti  
Fahrbares Tellergerüst  
Chariot porte-assiettes mobile  
Carrito para almacenaje de platos

art. cm.  
44830-52 60x60x103

**For pcs/Per pz 52**

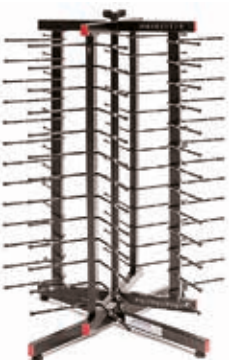

**Swivelling table top rack**  
Porta piatti rotante  
Drehbares Tischgerüst  
Porte-assiettes de table pivotant  
Soporte para almacenaje de platos

art. cm.  
44831-52 48x48x89

**For pcs/Per pz 52**



**Zippered plastic cover**  
Copertura in plastica  
Plastik Schutzhülle  
Housse en plastique  
Cubrecarrito, plástico

art. for/per  
44832-99 44830-72/44830-99



**Thermo cover**  
Copertura termica  
Thermo-Hülle  
Thermo-housse  
Cubrecarrito, térmico

art. for/per  
44833-99 44830-72/44830-99





**Thermic hot box**

Box termico  
Speisen-Kaste  
Caisson thermique  
Cajón térmico

art. cm. W  
44094-00 38x40,5x51,2 500

**Stainless steel box with double insulated wall. Analogic thermostat 30-90°C.**  
Box in acciaio inox a doppia parete coibentata. Termostato analogico 30-90°C.



**Refrigerated box**

Box refrigerato  
Speisen-Kaste  
Caisson réfrigéré  
Cajón refrigerado

art. cm.  
44094R00 38x40,5x51

**Stainless steel box with double insulated wall with chilling pack -32°C.**  
Box in acciaio inox a doppia parete coibentata. Refrigerazione a mezzo di una piastra eutettica -32°C.



**Table with hot box**

Tavolino con box termico  
Tisch mit Hot Box  
Table avec hot box  
Carrito con hot box

art. Ø cm. h. cm. W  
44094-02 90/54,6 77 500

**Table with fold down flaps. – Tavolo con flaps pieghevoli.**



**Table with hot box**

Tavolino con box termico  
Tisch mit Hot Box  
Table avec hot box  
Carrito con hot box

art. Ø cm. h. cm. W  
44094-04 90/54,6 78,6 500

**Table with fold down flaps. With capsizable top for stacking when not in use.**  
Tavolo con flaps pieghevoli. Ribaltabile e impilabile quando non in uso.



**Table with hot box**

Tavolino con box termico  
Tisch mit Hot Box  
Table avec hot box  
Carrito con hot box

art. Ø cm. h. cm. W  
44094-06 90/73 76 500

**Table with fold down flaps. Foldable for saving space when not in use. – Tavolo con flaps pieghevoli. Pieghevole per ridurre l'ingombro quando non in uso.**



**Fast food tray**

Vassoio fast food  
Serviertablett, Fast Food  
Plateau fast food  
Bandeja fast food

art. cm.  
41860-36 27x36,5  
41860-43 30,7x43,5  
41860-47 35,5x47



PP

**Fast food tray**  
Vassoio fast food  
Serviertablett, Fast Food  
Plateau fast food  
Bandeja fast food

art.	cm.
41861-44	30,7x44



NEW

PP

**Gastronorm tray**  
Vassoio Gastronorm  
Serviertablett, Gastronorm  
Plateau Gastronorm  
Bandeja Gastronorm

art.	cm.	col.
41862B11	53x32,5x1,6	●
41862C11	53x32,5x1,6	●
41862G11	53x32,5x1,6	●



NEW

PP

**Euronorm tray**  
Vassoio Euronorm  
Serviertablett, Euronorm  
Plateau Euronorm  
Bandeja Euronorm

art.	cm.	col.
41862B53	53x37x1,6	●
41862C53	53x37x1,6	●
41862G53	53x37x1,6	●



NEW

SS

**Universal tray collector trolley**  
Carrello ritiro vassoi universale  
Tablettabräumwagen Universal  
Chariot débarrassage plateaux universel  
Carro porta bandeja universal

art.	cm.
44803-10	47x55x153
44803-20	88x55x153

**12 cm between shelves. 4 swivel wheels 100 mm. Chrome-plated steel thread supports 6 mm.**  
Distanza fra piani 12 cm. 4 ruote girevoli 100 mm. Supporti in filetto acciaio cromato 6 mm.



NEW

SS

**Universal tray collector trolley**  
Carrello ritiro vassoi universale  
Tablettwagen Universal  
Chariot débarrassage plateaux universel  
Carro porta bandeja universal

art.	cm.
44803-30	129x55x153

**They can hold trays in different sizes (width ranging from 300 to 370 mm) including Euronorm and Gastronorm.** – Possono accogliere vassoi di varia misura (larghezza tra 300 e 370 mm) inclusi Euronorm e Gastronorm.



PP

**Disposable covers, 200 pcs**  
Coperture monouso, 200 pezzi  
Einweg-Schutzhüllen, 200 Stk.  
Housses usage unique, 200 pcs  
Cubreacarritos desechables, 200 pz

art.	for/per	h. cm.
42512-91	GN 1/1	180
42512-92	GN 2/1	180
	60x40	180



SS

**Roll holder**  
Porta rotolo  
Rollenhalter  
Dérouleur mural  
Portarollos

art.	cm.
42512-90	90x23x19



SS

**Utility rack GN 2/1**  
Carrello GN 2/1  
2/1 GN-Behälterwagen  
Chariot GN 2/1  
Carro GN 2/1

art.	cm.
44807-28	60x70x153,5

**Welded structure, 28 rails, 4 wheels, 2 with brakes.** – Struttura saldata, 28 guide, 4 ruote girevoli di cui 2 con freno.



SS

**Utility rack GN 2/1**  
Carrello GN 2/1  
2/1 GN-Behälterwagen  
Chariot GN 2/1  
Carro GN 2/1

art.	cm.
44807-36	73x62x171

**To be assembled, 18 rails, accomodates GN pans height 65 mm. Load max 300 kg.** – Fornito smontato, 18 guide, accoglie GN di h. 65 mm. Carico max 300 kg.



SS

**Utility rack GN 1/1**

Carrello GN 1/1  
1/1 GN-Behälterwagen  
Chariot GN 1/1  
Carro GN 1/1

art. cm.  
44807-18 38x62x164

**To be assembled, 18 rails, accomodates GN pans height 65 mm. Load max 150 kg.**

Fornito smontato, 18 guide, accoglie GN di h. 65 mm. Carico max 150 kg.



SS

**Utility rack GN 1/1**

Carrello GN 1/1  
1/1 GN-Behälterwagen  
Chariot GN 1/1  
Carro GN 1/1

art. cm.  
44801-09 38x62x94,5

**To be assembled, 9 rails, accomodates GN pans height 65 mm. Load max 75 kg.**

Fornito smontato, 9 guide, accoglie GN di h. 65 mm. Carico max 75 kg.



SS

**Baking sheet trolley**

Carrello porta teglie  
Backbleche-Wagen  
Chariot pour plaques  
Carro porta placas

art. cm.  
44826-00 52x72x85

**Pitch 7,5 cm. For 60x40 cm trays. S/steel top. Swivel castors ø 9.5 cm, 2 with brakes. – Passo 7,5 cm. Per teglie cm 60x40. Piano superiore inox. Ruote piroettanti ø cm 9,5 di cui 2 con freno.**



SS

**Serving trolley**

Carrello di servizio  
Mehrzweckwagen  
Chariot de service  
Carrito para desocupar

art. cm.  
44819-02 91x59x93

**To be assembled, 4 swivel castors, 2 with brakes. Load max 80 kg. – Fornito smontato, 4 ruote girevoli di cui 2 con freno. Carico max 80 kg.**



SS

**Serving trolley**

Carrello di servizio  
Mehrzweckwagen  
Chariot de service  
Carrito para desocupar

art. cm.  
44819-03 91x59x93

**To be assembled, 4 swivel castors, 2 with brakes. Load max 120 kg. – Fornito smontato, 4 ruote girevoli di cui 2 con freno. Carico max 120 kg.**



SS

**Serving trolley**

Carrello di servizio  
Mehrzweckwagen  
Chariot de service  
Carrito para desocupar

art. cm.  
44820-80 80x50x93,5  
44820-99 100x50x93,5

**To be assembled, 4 swivel castors, 2 with brakes. Max load per shelf kg 30. – Fornito smontato, 4 ruote girevoli di cui 2 con freno. Portata max. per ripiano kg 30.**



SS

**Serving trolley**

Carrello di servizio  
Mehrzweckwagen  
Chariot de service  
Carrito para desocupar

art. cm.  
44822-80 80x50x93,5  
44822-99 100x50x93,5

**To be assembled, 4 swivel castors, 2 with brakes. Max load per shelf kg 30. – Fornito smontato, 4 ruote girevoli di cui 2 con freno. Portata max. per ripiano kg 30.**



PP

**Serving trolley**

Carrello di servizio  
Mehrzweckwagen  
Chariot de service  
Carrito para desocupar

art. cm.  
44030-03 42x71x90



PP

**Bins and containers**

Cesti e contenitori  
Kasten und Körbe  
Récipients et containers  
Cubos y contenedores

art. cm.  
44031-04 52x39x12,7  
44031-05 52x39x17,7



PE

**Container**  
 Contenitore  
 Kaste  
 Réipient  
 Contenedor

art.	cm.
44031-01	33,7x23x56
44031-02	33,7x23x18,7



PP

**Serving trolley**  
 Carrello di servizio  
 Mehrzweckwagen  
 Chariot de service  
 Carrito para desocupar

art.	cm.
49995-04	97x51x99

**Load max 135 kg (45 kg per shelf).**  
 Carico max 135 kg (45 kg per ripiano).



SS

**Minibar restocking cart**  
 Carrello rifornimento frigobar  
 Wagen für Minibar-Versorgung  
 Chariot mini-bar  
 Carro servicio minibar

art.	cm.
44095-30	73x47x102

**3 PVC boxes with anti-tip cage for 40 bottles ø 6,5 cm max. Castor wheels ø 12,5 cm, 2 with brakes.** – Con 3 cassette in PVC, dotate di gabbia antiribaltamento per 40 bottiglie ø cm 6,5 max. Ruote piroettanti ø cm 12,5 di cui 2 con freno.



**Minibar restocking cart**  
 Carrello rifornimento frigobar  
 Wagen für Minibar-Versorgung  
 Chariot mini-bar  
 Carro servicio minibar

art.	cm.
44095-32	100x62x119

**Side handle. Key lock. 2 fixed and 2 swivel casters ø 16 cm 2 with brakes.** – Maniglia laterale di spinta. Chiusura con chiave. Ruote ø cm 16, di cui due fisse e due piroettanti con freno.



SS

**Utility rack GN 2/1**  
 Carrello GN 2/1  
 2/1 GN-Behälterwagen  
 Chariot GN 2/1  
 Carro GN 2/1

art.	cm.
44801-18	73x62x94,5

**To be assembled, 9 rails, accomodates GN pans height 65 mm. Load max 150 kg.**  
 Fornito smontato, 9 guide, accoglie GN di h. 65 mm. Carico max 150 kg.



SS

**Baking sheet trolley**  
 Carrello porta teglie  
 Backbleche-Wagen  
 Chariot pour plaques  
 Carro porta placas

art.	cm.
44826-20	69x49x187

**20 rails for baking sheets cm 60x40, height clearance 8 cm. Load max 100 kg.**  
 20 guide per teglie cm 60x40, distanza guide 8 cm. Carico max 100 kg.



**Baking sheet trolley, galvanized steel**  
 Carrello porta teglie, zincato  
 Backbleche-Wagen, verzinkt  
 Chariot pour plaques, galvanisé  
 Carro porta placas, galvanizado

art.	cm.
44825-20	51x50x170

**20 rails, height clearance 8 cm. Load max. 80 kg.**  
 20 guide, distanza guide 8 cm. Carico max 80 kg.

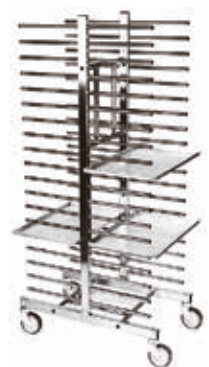

**Baking sheet trolley, galvanized steel**  
 Carrello porta teglie, zincato  
 Backbleche-Wagen, verzinkt  
 Chariot pour plaques, galvanisé  
 Carro porta placas, galvanizado

art.	cm.
44825-40	51x75x170

**40 rails, height clearance 8 cm. Load max 160 kg.**  
 40 guide, distanza guide 8 cm. Carico max 160 kg.



**SS**

**Dolly for cases**

Carrello porta cassette  
Plattformwagen  
Chariot à caisses  
Carretilla de transporte

art. cm.  
44026-60 65x45x12

**Load max 50 kg. – Carico max 50 kg.**



**PE**

**Platform cart**

Carrello trasporto materiali  
Plattformwagen  
Chariot de transport  
Plataforma móvil

art. cm.  
49378-00 82,6x52x98,7

**Three position handle ensures optimum handling whatever the load. Non slip deck, 2 swivel and 2 rigid castors. Load 181 kg. – Maniglia regolabile in 3 posizioni. Superficie antiscivolo. 2 ruote fisse, 2 pivotanti. Carico 181 kg.**



**PP**

**Trolley, convertible**

Carrello convertibile  
Plattformwagen, umwandelbar  
Chariot convertible  
Carretilla convertible

art. cm.  
49379-00 56x53x43,5

**Four non-marking casters (two rear locking), 2 swivel and 2 rigid. – Ruote antiraccia di cui 2 fisse e 2 girevoli, ruote posteriori bloccabili.**





# CLEANING & SAFETY

## PULIZIA & SICUREZZA





PP

**Changing table**

Fasciatoio da parete  
Windeln-Tisch  
Table à langer  
Mesa cambia-pañales

art.	cm.
49336-00	91x71x49,6
49336-02	60x88x48

Rated for continuous use up to 23 kg. – Portata max in uso 23 kg.



PP

**Sturdy chair**

Seggiolone  
Kinderstuhl  
Chaise d'enfant  
Silla niños

art.	cm.
49337-00	60x60x75,5
49337-01	29x47x8,3

For children up to 3 years old or 18 kg weight. With Microban antimicrobial protection. – Adatto a bambini fino a 3 anni o 18 kg di peso. Con protezione antibatterica in Microban.



W

**Sturdy chair**

Seggiolone  
Kinderstuhl  
Chaise d'enfant  
Silla niños

art.	cm.	col.
49335-01	50x50x75	●
49335-02	50x50x75	●

Suitable for children from 6 months to 3 years. Max 20 kg.  
Adatto ai bambini da 6 mesi a 3 anni. Fino a 20 kg.



**Trolley Quick Cart**

Carrello Quick Cart  
Quick Cart-Wagen  
Chariot Quick Cart  
Carretilla Quick Cart

art.	cm.	Kg.	cap. m3
44178-01	42x36x43	6,5	0,05
44178-02	42x36x53	7,0	0,06

Versatile compartments allow for multiple configurations and uses. Removable caddy. Adjustable dividers. Teflon fabric protector, repels water, oil and stains. Reinforced rubberised kick plate. – Scomparti versatili consentono molteplici configurazioni e usi. Cestello estraibile. Divisori removibili. Rivestimento in Teflon, respinge acqua, olio e macchie. Scocca rinforzata in gomma.



**Collapsible frame, powder coated steel**

Telaio pieghevole, acciaio verniciato  
Klappbares Gestell, pulverbeschichtete Stahl  
Châssis repliable, acier peint  
Carre plegable, acero pintado

art.	cm.	lt.
44178-15	51,5x61x84	150
44178-16	89x61x84	300

Collapsible frame enables efficient storage. Compact, lightweight design for superior manoeuvrability. Remains collapsible with or without cover. – Telaio pieghevole consente uno stoccaggio efficiente. Design compatto e leggero per una maggiore manovrabilità. Rimane pieghevole con o senza copertura.



**Vinyl bag, black**

Sacco vinile, nero  
Vinyl-Sack, schwarz  
Sac en vinyle, noir  
Bolsa de vinilo, negro

art.	cm.	lt.
44178-17	39x57x69	150
44178-18	78x57x69	300

**Durable, high capacity (100 kg) vinyl bag accommodates large loads; easy-to-clean.** – Sacchi in vinile durevoli, ad alta capacità (100 kg); facili da pulire.



**Vinyl bag cover, black**

Copertura vinile, nero  
Vinyl-Sack-deckel, schwarz  
Couvercle à sac en vinyle, noir  
Tapa para bolsa de vinilo, negro

art.	cm.
44178-19	64x50x23
44178-20	89x66x23

**Multiple, built-in storage pockets on each side. Convenient, Quick-Access-Lid provides easy access to contents inside of cart without having to remove cover.** – Con tasche integrate su ogni lato. Comodo, accesso rapido all'interno del carrello, senza dover rimuovere il coperchio.



SS

**Service trolley**

Carrello servizio  
Servierwagen  
Chariot de service  
Carro de servicio

art.	cm.
44096-01	120x52x137

**Stainless steel structure. MDF cherry wood tops. 2 folding bag holders with linen laundry bag. Gray rubber bumpers. Castor wheels ø 12.5 cm.**  
Struttura inox. Piani in nobilitato color ciliegio. 2 reggisacchi pieghevoli con sacco in tela. Paracolpi in gomma grigia. Ruote piroettanti ø 12,5 cm.



SS

**Service trolley**

Carrello servizio  
Servierwagen  
Chariot de service  
Carro de servicio

art.	cm.
44096-02	119x52x134

**Stainless steel tube structure. MDF cherry tops and panels. Folding bag holder with linen laundry bag. Base with perimeter bumper in gray non-marking rubber. Castor wheels ø 15 cm.** – Struttura inox. Piani e pannelli in nobilitato color ciliegio. Reggisacchi pieghevoli con sacco in tela. Base con paracolpi perimetrale in gomma grigia antitraccia. Ruote piroettanti ø 15 cm.



SS

**Service trolley**

Carrello servizio  
Servierwagen  
Chariot de service  
Carro de servicio

art.	cm.
44096-03	139x52x134

**Stainless steel structure. MDF cherry tops and panels. Folding bag holder with linen laundry bag. Base with perimeter bumper in gray non-marking rubber. Castor wheels ø 15 cm.** – Struttura inox. Piani e pannelli in nobilitato color ciliegio. Reggisacchi pieghevoli con sacco in tela. Base con paracolpi perimetrale in gomma grigia antitraccia. Ruote piroettanti ø 15 cm.



PP

**Service trolley**

Carrello di servizio  
Servicewagen  
Chariot de service  
Carro de habitaciones

art.	cm.	lt.	Kg.
44174-24	177x58x107	120+120	26,4

**Wheels ø 125 mm, 2 bag holders + 2 bags lt 120. Made in PP copolymer.**  
Ruote ø 125 mm, 2 portasacchi pieghevoli + 2 sacco lt 120. Prodotto in PP copolimero.





PP

**Service trolley**

Carrello di servizio  
Servicewagen  
Chariot de service  
Carro de habitaciones

art.	cm.	lt.	Kg.
44177-12	104x56x130	150	26

**Frame in tubular steel rilsan coated. Wheels ø 125 mm. 3 wooden shelves 50x46 cm. Bag holder + canvas bag polyester 55x55x94 cm.**  
Montanti in tubolare inox verniciato rilsan. Ruote ø 125 mm. 3 ripiani in legno 50x46 cm. Portasacco+sacco in tela poliestere 55x55x94 cm.



PP

**Housekeeping cart for linen collection**

Carrello portabiancheria  
Hotelwäschewagen  
Chariot d'étage à linge  
Carro de recogida de ropa

art.	cm.	lt.	Kg.
44176-30	105x55x105	300	12,5

**Frame in tubular steel rilsan coated. Wheels ø 125 mm. Nylon bag.** – Montanti in tubolare inox verniciato rilsan. Ruote ø 125 mm. Sacco in nylon plastificato.



**Housekeeping cart for linen collection**

Carrello portabiancheria  
Hotelwäschewagen  
Chariot d'étage à linge  
Carro de recogida de ropa

art.	cm.	lt.	Kg.
44175-15	62x60x103	150	6,39

**Capacious canvas bag laminated washable at 30°C. Folding frame. Swivel casters ø 80 mm.**  
Capiente sacco in tela plasticata lavabile a 30°C. Telaio pieghevole. Ruote piroettanti ø 80 mm.



**Cleaning system, Pulse**

Sistema di pulizia, kit Pulse  
Reinigungssystem Pulse  
Système de nettoyage Pulse  
Sistema de limpieza Pulse

art.	cm.
44151-00	12,4x9,5x142

**Aluminum frame 40 cm and 2 microfibre mops. On-board reservoir 700 ml that allows to clean up to 80 sqm.** – Telaio in alluminio con velcro da 40 cm, 2 mop in microfibra. Dotato di deposito integrato da 700 ml che permette di pulire fino a 80 mq.



**Microfibre mops**

Mop in microfibra  
Microfiber-Mops  
Franges en microfibre  
Fregadoras de microfibra

art.	cm.	des.	U. Pack
44151-AA	40x14	Wet	10
44151-AB	40x14	High absorb	10
44151-AC	40x14	Scrubber	10

**Wet use, high absorbency, for 80 sqm. Launderable up to 500 times (200 with bleach) at high water temperature.** – Uso umido ad elevata assorbenza 80 mq. Ciclo di vita: 500 lavaggi (200 con candeggina) ad elevate temperature.



**Dust beater "V" sweeper complete**

Scopa a forbice completa  
Doppel-Wischmop  
Balai double mop  
Escoba doble

art.	h. cm.
44160-03	135

**Opening angle 140° about. Cotton mops length 100 cm.** – Apertura 140° circa. Frange in cotone 100 cm.



**Mechanical sweeper**

Aspirapolvere meccanico  
Kehrer mit mechanischem Antrieb  
Balai mécanique  
Escoba mecánica

art.	cm.	lt.
44150-19	28,5x25x102	0,6

**ABS and galvanised steel construction. Ideal for hard floors and low pile carpets. Sweeping path 19 cm.** – ABS e acciaio galvanizzato. Ideale sia per tappeti/moquette a pelo corto che per pavimenti. Battuta 19 cm.



PP

**Broom + dust pan**

Scopa + alza immondizia  
Kehrset mit Stiel und Schmutzcontainer  
Balai + pelle  
Escoba + recogedor

art.	cm.
44149-03	28,6x13x32,5

**Self opening and closing lid. Broom hanger bracket.** – Porta immondizia con coperchio. Staffa di supporto per scopa.



**Dustpan**

Paletta manico lungo  
Müllschaufel  
Pelle à poussière  
Pala

art. 44170-00



**Broom, aluminum rod**

Scopa, manico alluminio  
Besen mit Alustiel  
Balai, manche alu  
Escoba, mango alumimio

art. h. cm.  
44170-01 80



**Cleaning wand**

Scopa spingiacqua  
Abzieher  
Balai raclette  
Escoba

art. cm.  
44148-01 116,8x40

**Blade made of soft double mass squeegee foam supported by a galvanized metal frame.**

Testa della scopa realizzata in morbida gommaspugna a doppio strato sostenuta da telaio in metallo galvanizzato.



**Wet mop handles**

Manico per mop  
Nassmopp-Stiele  
Supports pour franges  
Mangos para fregonas

art.	cm.	col.
44141-01	152,4	●
44141-03	152,4	●

**Polypropylene/Glass fiber.**  
Polipropilene/fibra di vetro.



**Cotton-end string mop**

Mop a strisce in cotone  
Spaghetti-Mop mit Baumwollend  
Frangé à ficelles en coton  
Mopa de algodón

art.	gr.
44142-40	400



**Cotton mop rod, screw fitting**

Manico per mop, attacco filettato  
Mop-Stange mit Schraubanschluss  
Manche pour mop avec attache à vis  
Mango para fregadora, conexión tornillo

art.	Ø cm.	cm.
44167-13	2,2	130

**Red lacquered iron. Lightweight and rustproof.**  
Ferro verniciato rosso. Leggero ed inossidabile.



**Cotton mop, screw fitting**

Mop in cotone, attacco filettato  
Baumwollmop mit Schraubanschluss  
Mop en coton avec attache à vis  
Mopa de algodón

art.	gr.
44166-28	280



**Telescopic rod**

Manico telescopico  
Teleskopstange  
Manche telescopique  
Mango telescópico

art.	Ø cm.	cm.
44161-00	2,3	97>184

**Two-piece anodized aluminum rod.**  
Alluminio anodizzato due pezzi.



**Mop holder**

Pinza per mop  
Wischmophalter  
Pince faubert  
Pinza

art. 44164-00

**Universal ring allows the use of any handle with from ø 20 to 24 mm. – Ghiera universale consente l'utilizzo di qualsiasi manico con ø 20>24 mm.**





**Cotton-end string mop**

Mop a strisce in cotone  
Spaghetti-Mop mit Baumwollendend  
Frange à ficelles en coton  
Mopa de algodón

art.	gr.
44165-35	350
44165-40	400
44165-50	500



**Microfibre cloth, 12 pcs**

Panno in microfibra, 12 pz  
Mikrofasertuch, 12 Stk  
Carré en microfibra, 12 pcs  
Paño de microfibra, 12 pz

art.	cm.	col.
44147-00	40,6x40,6	●
44147-01	40,6x40,6	●
44147-02	40,6x40,6	●
44147-03	40,6x40,6	●

**Launderable up to 100 times with bleach and 250 without bleach. – Dura 100 lavaggi con candeggina e 250 senza.**



PP

**2-sided floor sign**

Cavalletto di segnalazione a 2 lati  
2-seitig, Warnschild  
Panneau d'avertissement 2 côtés  
Señal de suelo 2 lados

art.	h. cm.
44077-00	57
44077-CC	67



NEW

**Safety chain for floor signs**

Catenella di sicurezza per cavalletti  
Kunststoff-Kette für Warnschilder  
Chaîne de sécurité pour panneaux de sol  
Cadena plástica para señales de suelo

art.	cm.
44077-06	600



NEW

**Telescopic door sign**

Segnalatore telescopico di sicurezza  
Teleskop-Sicherheitstürschild  
Panneau de sécurité télescopique  
Señal de seguridad telescópico

art.
44077-10



NEW

**Sanitizing detergent**

Detergente igienizzante  
Desinfektionsmittel  
Détergent désinfectant  
Detergente desinfectante

art.	lt.
48610-50	5

**For hard surfaces. – Per superfici dure.**



PP

**Multi-purpose trolley**

Carrello multiuso  
Allzweckwagen  
Chariot multi-usage  
Carro de limpieza

art.	cm.
44173-00	97x68x111

**Bag holder with cover, bag lt. 120, pan with hooks, 2 buckets 4 lt. and 2 buckets 15 lt., wringer. – Portasacco con cop., sacco lt. 120, vaschetta con ganci, 2 secchi 4 lt., 2 secchi 15 lt., strizzatore.**



PP

**Mopping trolley with press**

Carrello lavapavimenti con strizzatore  
Wringer Reinigungswagen mit Presse  
Chariot de ménage avec presse  
Carro con prensa escurridora

art.	cm.
44171-24	62x42x90

**Wringer and 25 lt. bucket. With storage compartment. PSV reinforced handle. Strizzatore e 1 secchio lt. 25. Vano portaoggetti. Impugnatura in PSV completa di rinforzi.**



PP

**Mopping trolley with press**

Carrello lavapavimenti con strizzatore  
Wringer Reinigungswagen mit Presse  
Chariot de ménage avec presse  
Carro con prensa escurridora

art.	cm.
44171-50	69x42x90

**Wringer and 2 buckets lt. 25 each. Painted handle, reversible. – Strizzatore e 2 secchi da lt. 25. Impugnatura verniciata, reversibile.**



PP

**Mopping trolley with press**

Carrello lavapavimenti con strizzatore  
Wringer Reinigungswagen mit Presse  
Chariot de ménage avec presse  
Carro con prensa escurridora

art.	cm.
44172-30	47x40x93

**Single tank with wringer.**  
Monovasca con strizzatore.



PP

**Graduated bucket**

Secchio graduato  
Eimer mit Skala  
Seau gradué  
Cubo con medidas

art.	cm.	lt.	col.
44169B06	24x19x21,5	6	●
44169R06	24x19x21,5	6	●



PP

**Graduated bucket**

Secchio graduato  
Eimer mit Skala  
Seau gradué  
Cubo con medidas

art.	cm.	lt.	col.
44169B14	34x33,5x28	15	●
44169R25	37x36,5x32	25	●



PP

**Bucket with wringer**  
Secchio con strizzatore  
Eimer mit Presse  
Seau avec essoreur  
Cubo con prensa

art.	cm.	lt.
44168-12	35x27x29,5	12

**With graduated scale 0-12 lt.**  
Scala graduata 0-12 lt.



PP

**Waste container**

Cestino  
Abfallbehälter  
Collecteur  
Papelera

art.	Ø cm.	h. cm.
44097-00	30	32



PE

**Step on bin**  
Pattumiera a pedale  
Pedaleimer  
Poubelle à pédale  
Colector a pedal

art.	cm.	lt.
49933-30	50x31x56,5	30
49933-50	53x34x72	50
49933-68	56x37x78	68



**Waste container SLIM JIM**

Contentore rifiuti  
Abfallbehälter  
Collecteur  
Colector

art.	cm.	lt.
49931-60	59x28X63	60
49931-87	56x28X76	87



PP

**Hinged lid**

Coperchio ancorato  
Klapp-Deckel  
Couvercle à charnière  
Tapa abatible

art.	cm.
49931-00	55,6x34x3





PP

**Lid**  
Coperchio  
Deckel  
Couvercle  
**Tapa**

art.	cm.	col.
49931A00	52x29x7	●
49931C04	52x29x7	●
49931B05	52x29x7	●
49931B02	52x29x7	●
49931B03	52x29x7	●
49931B01	52x29x7	●



PP

**Dolly SLIM JIM**  
Carrello  
Transportwagen  
Chariot  
**Carrito**

art.	cm.
49931-64	60,6x37,4X21

**Side clip allows to tow together more trolleysdal release fast and simple.** – Aggancio laterale a clip che permette di trainare insieme diversi carrelli. Rilascio a pedale semplice e veloce.



PE

**Mobile pedal bin**  
Pattumiera a pedale  
Pedaleimer  
Poubelle à pédale  
**Colector a pedal**

art.	cm.	lt.
44095-12	48x55x93	120

**Certified UNI EN 840. Withstanding chemical, can be washed and sterilized.**  
Certificata UNI EN 840. Resistente agli agenti chimici, lavabile e sterilizzabile.



PP

**Mobile pedal bin**  
Pattumiera a pedale  
Pedaleimer  
Poubelle à pédale  
**Colector a pedal**

art.	cm.	lt.
44095-18	40x65x81	80



PP

**Mobile pedal bin**  
Pattumiera a pedale  
Pedaleimer  
Poubelle à pédale  
**Colector a pedal**

art.	cm.	lt.	col.
44096-80	48x50x78	80	○
44096B80	48x50x78	80	●
44096Y80	48x50x78	80	●
44096R80	48x50x78	80	●
44096G80	48x50x78	80	●



NEW

PP

**Mobile pedal bin**  
Bidone a pedale  
Pedaleimer  
Poubelle à pédale  
**Colector a pedal**

art.	cm.	lt.
44098-08	48x50x78	80
44098-12	48x55x93	120
44098-24	58x73x107	240



NEW

**Label Covid-19**  
Etichetta COVID-19  
Etikett Covid-19  
Étiquette Covid-19  
**Etiqueta Covid-19**

art.	dim. cm.
44098-03	15x21



**Refuse bag holder trolley**  
Carrello portasacco  
Sackhalterwagen  
Chariot porte-sac  
**Colector móvil**

art.	cm.	lt.
44089-12	58x56x102	120





PP

**Mobile pedal bin, fire-proof**

Pattumiera a pedale, ignifuga  
Pedaleimer, feuersicher  
Poubelle à pédale, ignifugée  
Colector a pedal, ignifugo

art.	cm.	lt.	col.
49899-01	46x32x80	70	●

**Mechanical parts in stainless steel. The lid can be removed.** – Parti meccaniche in acciaio inox. Coperchio staccabile.



**Pedal bin lids**

Coperchi pattumiera  
Pedaleimer-Deckel  
Couvercles poubelle  
Tapas para colector

art.	cm.	col.
49899-91	46x32	●
49899-92	46x32	●
49899-93	46x32	●
49899-94	46x32	●
49899-95	46x32	●



PE

**Tilt truck**

Benna ribaltabile  
Fallen Eimerwagen  
Benne  
Carrito plegable

art.	cm.	lt.	Kg.
49934-04	145x68x86	400	205
49934-06	164x77x97	600	272
49934-08	180x85x107	800	570



PE

**Domed linged lid**

Coperchio a doppia apertura  
Doppel-Deckel  
Couvercle double  
Tapa doble

art.	cm.
49934-14	132x71x23
49934-16	155x81x23
49934-18	169x87x23



PP

**Folding ladder**

Scaletta pieghevole  
Klappleiter  
Marche-pied pliable  
Escalera plegable

art.	cm.
49378-48	48,6x17x63

**Load 150 kg. Resists from 0 to 50 °C.**  
Carico 150 kg. Resiste da 0 a 50°C.



PE

**Pallet**

Pallet  
Pallet  
Palette  
Racks para suelos

art.	cm.	Kg.
49373-05	80x120x14	4,6

**Static load 1000 kg. Appropriate for food.**  
Carico statico 1000 kg. Per uso alimentare.



**Dunnage rack**

Pedana  
Lageruntersätze  
Palettes  
Bancada

art.	cm.	load kg
49371-09	91,4x56x30,5	68
49371-12	122x56x30,5	136

**Rust and corrosion-proof polymer material.**  
Materiale polimerico resistente alla ruggine e alla corrosione.





SS

**Floor standing ashtray**  
Posacenere a colonna  
Standascher/Abfalleimer  
Cendrier sur pied  
Contenedor con cenicero

art.	Ø cm.	h. cm.
49897-09	9	86



SS

**Standing ashtray/bin**  
Posacenere/pattumiera  
Standascher/Abfalleimer  
Cendrier/poubelle  
Cenicero/papelera

art.	Ø cm.	h. cm.
49898-30	30	60



PP

**Standing ashtray**  
Posacenere/fioriera  
Standascher  
Cendrier sur pied  
Cenicero

art.	Ø cm.	h. cm.
49892-40	40	60

**Included bag of sand 1,5 kg.**  
Incl. sacchetto sabbia kg 1,5.

## HYGIENE ACCESSORIES ACCESSORI PER L'IGIENE



NEW

**Hand hygiene station**  
Stazione igiene mani  
Händehygenestation  
Station de désinfection des mains  
Estación de higiene de manos

art.	cm.
44178-69	93x38,5x19,5

**Dispenser not included.** – Erogatore non incluso.



NEW

**Automatic dispenser**  
Erogatore automatico  
Automatischer Spender  
Distributeur automatique  
Dispensador automático

art.	cm.
44178-66	14,2x14,2x28x4

**Dose: 0,4 ml.**



NEW

**Cleansing foam**  
Schiuma detergente  
Reinigungsschaum  
Mousse nettoyante  
Espuma limpiadora

art.	cm.	ml.
44178-67	26,5x16x7	1100

**Dye-free and fragrance-free.**  
Priva di coloranti e senza profumo.



NEW

**Sanitizing gel**

Gel igienizzante  
Desinfektionsgel  
Gel désinfectant  
Gel desinfectante

art. ml.  
48601-05 500

**With alcohol for a sanitizing action. Enriched with glycerin and chamomile to moisturize the skin.**  
Con alcol ad azione igienizzante. Arricchito con glicerina e camomilla per idratare.



NEW

**Forehead infrared thermometer**

Termometro infrarossi frontale  
Infrarot-Stirnthermometer  
Thermomètre infrarouge frontal  
Termómetro infrarrojo delantero

art. cm. range  
49726-00 2,5x5,6x12,8 32+42°C

**With Biomaster anti-bacterial additive. Resolution: 0,1°C/°F. Accuracy: ± 0,3°C. No medical device.** – Con additivo antibatterico Biomaster. Risoluzione: 0,1°C/°F. Precisione: ± 0,3°C. Non è dispositivo medico.



NEW

**Face masks**

Mascherine monouso  
Einwegmasken  
Masques jetables  
Mascarillas desechables

art. U. Pack  
48551-00 50

**No medical device.** – Non è un presidio medico.



NEW

PC

**Face shield**

Visiera facciale  
Gesichtsschutz  
Écran facial  
Visera

art. my cm.  
48550-00 375 29,4x20,5

**Hypoallergenic sponge, plasticized band, adjustable velcro closing, washable with alcohol. No medical device.** – Spugna anallergica, fascia plasticata, velcro di chiusura regolabile, lavabile con alcool. Non è un presidio medico.



**Gloves, nitrile**

Guanti nitrile  
Handschuhe, Nitril  
Gants en nitrile  
Guantes de nitrilo

art.	pcs/pz	size/T.
48519-01	100	S
48519-02	100	M
48519-03	100	L
48519-04	100	XL

**Treatment Powder free. Latex-free. Finish microgrip.** – Trattamento Powder free. Latex free. Finitura Microgrip.



HDPE

**Gloves**

Guanti  
Handschuhe  
Gants  
Guantes

art.	l. cm.	pcs/pz	size/T.
48522-24	24	500	one size

**Palm and fingers microgrip finishing.**  
Finitura palmo e dita microgrip.



**Apron, LDPE**

Grembiule LDPE  
Schurz, LDPE  
Tablier, LDPE  
Delantal, LDPE

art.	dim. cm.	pcs/pz
48524-75	75x120	50

**Waterproof and resistant, length 120 cm from the chest, total length 140 cm.**  
Impermeabile e resistente, lunghezza 120 cm dal petto, totale 140 cm.



**Paper cap**

Bustina carta  
Papier Mütze  
Calot papier  
Gorro barco papel

art.	pcs/pz
48528-00	100

**Double paper processing, absorbent, adjustable size, ventilated.** – Carta doppia lavorazione, fascia assorbi sudore, adesivo regolabile, aerata.



**Cap, TNT**

Cuffia, TNT  
Einweghauben, TNT  
Charlotte, TNT  
Cubrecabezas, TNT

art.	pcs/pz
48527-00	100

**Pleated cap, TNT 16gr/m2, very light, soft elastic, ø 50 cm.** – Cuffia plissettata TNT 16gr/m2, molto leggera, morbido elastico, ø 50 cm.



**Visitor kit, TNT**

Kit visitatore, TNT  
Besucher-Kits, TNT  
Kit visiteur, TNT  
Conjunto visitador, TNT

art.
48525-03

**1 TNT overall and cap, 1 CPE overshoes.**  
1 camice e cuffia in TNT e 1 set copriscarpe CPE.



**PE**

**Overshoes**

Copriscarpe  
Überschuhe  
Sur-chaussures  
Cubrezapatos

art.	l. cm.	pcs/pz
48526-44	44	110

**PE double-thickness, waterproof, elastic ankle, embossed bottom.** – PE doppio spessore, impermeabili, elastico alla caviglia, fondo gofrato.



**NEW**

**Gel/gloves dispenser stand + gel wall support**

Stand gel/guanti + supporto murale gel  
Gel-/Hanschuhständer + Gel-Wandhalterung  
Support gel/gants + support mural gel  
Soporte gel/guantes + soporte gel de pared

art.	Ø cm.	h. cm.
49961-10	28	105+24,5

**Painted steel.** – Acciaio verniciato.



**NEW**

**Gloves wall box dispenser**

Dispenser guanti murale  
Wand-Handschuhspender  
Distributeur de gants mural  
Dispensador de guantes de pared

art.	cm.
49961-01	25x13,5x10

**Painted steel.** – Acciaio verniciato.



**NEW**

**Gel dispenser wall support**

Supporto murale per gel  
Wandhalterung für Gel  
Support mural pour gel  
Soporte de pared para gel

art.	Ø cm.	cm.
49961-02	9	19x12,5x10

**Painted steel.** – Acciaio verniciato.



**NEW**

**SS**

**Foot pedal gel dispenser**

Dispenser a pedale per gel  
Pedalspender für Gel  
Distributeur à pédales pour gel  
Dispensador a pedal para gel

art.	cm.	Kg.
49963-01	28x15x100	8

**Mobile or screw-on. Adapted to all pump bottles up to Ø 11 cm and from 7 to 30 cm height. Anti-theft: reduced opening 6 cm, screwed (allen key supplied).** – Mobile o avvitabile. Adattabile a tutti i dispenser fino a Ø 11 cm e H da 7 a 30 cm. Antifurto: apertura ridotta 6 cm, avvitata (chiave a brugola fornita).





NEW  
SS

**Gloves dispenser box**  
Dispenser guanti  
Handschuhspender  
Distributeur de gants  
Dispensador de guantes

art.	cm.
49963-03	25x14x9
49963-04	26x8x13,5



NEW  
SS

**Gloves dispenser box**  
Dispenser guanti  
Handschuhspender  
Distributeur de gants  
Dispensador de guantes

art.	cm.
49963-15	25,3x8,2x13,2



NEW  
SS

**Visitor's kit dispenser box**  
Dispenser kit visitatore  
Besucher-Kit-Spender  
Distributeur kit visiteur  
Dispensador conjunto visitador

art.	cm.
49963-13	12,3x10,4x43,5



NEW  
SS

**Masks dispenser box**  
Dispenser mascherine  
Maskenspender  
Distributeur masques  
Dispensador de mascarillas

art.	cm.
49963-06	8,7x4,7x26



NEW  
SS

**Masks dispenser box**  
Dispenser mascherine  
Maskenspender  
Distributeur masques  
Dispensador de mascarillas

art.	cm.
49963-17	8,7x4,7x25,8



NEW  
SS

**Caps dispenser box**  
Dispenser cuffie  
Haubenspender  
Distributeur de charlottes  
Dispensador reddecillas

art.	cm.
49963-08	26x10,5x28
49963-09	31x27,7x19,5



NEW  
SS

**Caps dispenser box**  
Dispenser cuffie  
Haubenspender  
Distributeur de charlottes  
Dispensador reddecillas

art.	cm.
49963-11	29,5x10,5x14,5



NEW  
SS

**Caps dispenser box**  
Dispenser cuffie  
Haubenspender  
Distributeur de charlottes  
Dispensador reddecillas

art.	cm.
49963-19	25,3x10,2x27,3



NEW  
SS

**Caps dispenser box**  
Dispenser cuffie  
Haubenspender  
Distributeur de charlottes  
Dispensador reddecillas

art.	cm.
49963-21	29,7x9,6x13



**BARRIER SHIELDS PLEXIGLASS**  
PANNELLI PROTETTIVI PLEXIGLASS

NEW



An appealing, practical and quick solution for urgent social distancing requirements. Can be used in almost any location, such as supermarkets, petrol stations, bakeries, pharmacies, medical practices, meeting places, restaurants, sales counters, schools, cash points, office tables, conference rooms, receptions, counselling centres and many more. Can be placed on existing countertops as an added layer of protection. Available in a variety of sizes, with or without pass-through windows. A safe communication solution that offers excellent protection against infections spread by droplets of all kinds when talking to people during daily work and everyday life during and after a viral epidemic. Transparent plex material 5 mm thick. Interlocking feet. Available in standard or customized sizes on request. Packaging: transparent nylon + havana cardboard.

Una soluzione accattivante, pratica e rapida per le attuali esigenze di allontanamento sociale. Possono essere utilizzate in quasi tutti i luoghi, come supermercati, distributori di benzina, panetterie, farmacie, studi medici, luoghi di incontro, ristoranti, sportelli, scuole, scrivanie, tavoli d'ufficio, sale conferenze, ricevimenti, centri di consulenza e molti altri. Possono essere posizionati su tutte le superfici esistenti come ulteriore livello di protezione. Disponibili in varie dimensioni, con o senza finestre passanti. Una soluzione di comunicazione sicura che offre un'eccellente protezione contro le infezioni diffuse da goccioline di ogni tipo quando si parla alle persone durante il lavoro e la vita quotidiana e dopo un'epidemia virale. Materiale plex trasparente spessore 5 mm. Piedini ad incastro. Disponibili in misure standard o personalizzate su richiesta. Imballo: nylon trasparente+cartone avana.

**Sneeze guard with pass-through window**

Barriera protettiva con passacarte  
Hygieneschutz mit Durchreiche  
Panneau avec ouvertures passe-documents  
Mampara de protección con ventanilla abierta



art.	dim. cm.	h. cm.	window cm.
48710-02	60x27,5	70	25x15
48710-03	80x27,5	70	25x15
48710-01	100x27,5	70	25x15

**Interlocking base supports 27,5x28 cm. – Basi supporto ad incastro 27,5x28 cm.**

**Sneeze guard with pass-through window**

Barriera protettiva con passacarte  
Hygieneschutz mit Durchreiche  
Panneau avec ouvertures passe-documents  
Mampara de protección con ventanilla abierta



art.	dim. cm.	h. cm.	window cm.
48710-05	60x23	70	25x15
48710-06	80x23	70	25x15
48710-04	100x23	70	25x15
48710-08	60x23	90	25x15
48710-09	80x23	90	25x15
48710-07	100x23	90	25x15

**Interlocking base supports 23x40 cm. – Basi supporto a incastro 23x40 cm.**





**Sneeze guard**  
 Barriera protettiva  
 Hygieneschutz  
 Panneau de protection  
 Mampara de protección

art.	dim. cm.	h. cm.
48711-02	60x23	70
48711-03	80x23	70
48711-01	100x23	70

**Interlocking base supports 27,5x28 cm. – Basi supporto a incastro 27,5x28 cm.**



**Sneeze guard**  
 Barriera protettiva  
 Hygieneschutz  
 Panneau de protection  
 Mampara de protección

art.	dim. cm.	h. cm.
48711-05	60x23	70
48711-06	80x23	70
48711-04	100x23	70
48711-08	60x23	90
48711-09	80x23	90
48711-07	100x23	90

**Interlocking base supports 23x40 cm. – Basi supporto a incastro 23x40 cm.**



**Sneeze guard - BAR PROTECTION**

Barriera protettiva  
 Hygieneschutz  
 Panneau de protection  
 Mampara de protección

art.	dim. cm.	h. cm.	window cm.
48712-08	80x20	70	60x20
48712-10	100x20	70	79x20

**Interlocking base supports 20x55 cm. – Basi supporto a incastro 20x55 cm.**



**Sneeze guard - COUNTER BARRIER**

Barriera protettiva  
 Hygieneschutz  
 Panneau de protection  
 Mampara de protección

art.	dim. cm.	h. cm.
48713-08	80x20	50
48713-10	100x20	50
48713-15	150x20	50

**Interlocking base supports 20x32 cm. – Basi supporto a incastro 20x32 cm.**



**Self-standing guard**  
 Barriera autoportante  
 Hygieneschutz, freistehend  
 Panneau de protection autoportante  
 Mampara de protección de suelo

art.	dim. cm.	h. cm.
48714-19	150x100	190





**Table sneeze guard**

Barriera da tavolo  
Tisch-Hygienschutz  
Panneau de protection de table  
Mampara de protección de mesa

art.	dim. cm.	h. cm.
48715-07	70x30	65



**Table sneeze guard - OUTDOOR**

Barriera da tavolo  
Tisch-Hygienschutz  
Panneau de protection de table  
Mampara de protección de mesa

art.	dim. cm.	h. cm.
48716-07	70x8	65

**Adjustable wind-stop system.** – Sistema di fissaggio antivento adattabile alla misura del tavolo.

**BARRIER SHIELD**  
BARRIERA PROTETTIVA

NEW

**Solid self-supporting structure in aluminum and PP resin. Ultra-clear screen. Attractive design. Rubber feet. Opening for pass-through of documents height 3,5 cm. If desired can be fixed to the surface with double-sided tape or screws. Made of 3 mm thick transparent compact polycarbonate. Washable and sanitizable with non aggressive detergent solutions. Components easily assembled without need of special tools. Equipped with handles to easily be move elsewhere. Adaptable to most sales counters thanks to the possibility of placing modules side by side. Packaging with instruction sheet and screws/bolts kit.**

Solida struttura autoportante in alluminio e resina PP. Schermo ultratrasparente. Design accattivante. Piedini di sostegno. Apertura per passaggio documenti altezza 3,5 cm. Possibilità di fissaggio sulla superficie di appoggio tramite biadesivo o viti. Realizzata in policarbonato compatto trasparente di spessore 3 mm. Lavabile ed igienizzabile con soluzioni detergenti non aggressive. Componenti facilmente assemblabili senza l'utilizzo di attrezzi particolari. Dotata di maniglie per facilitarne lo spostamento. Adattabile a gran parte dei banchi vendita grazie alla possibilità di affiancare i moduli. Confezione con foglio d'istruzioni e kit viti/bulloni.



**Sneeze guard**

Barriera protettiva  
Hygienschutz  
Panneau de protection  
Mampara de protección

art.	l. cm.	h. cm.
48701-08	80	80
48701-12	120	80

**Thickness 3 mm.** – Spessore 3 mm.

PC





**Tubular structure in stainless steel matte finish or black lacquered ø 63 mm, thickness 0,8 mm. 4-way retractable polyester black belt length 2,13 meters, width 4,8 cm. Ballasted base ø cm 31 with rubber under the base. Weight 10 kg. Overall height 1 mt. Possibility to apply landscape display.**

Struttura tubolare in acciaio inossidabile finitura satinata o laccata nera ø 63 mm, spessore 0,8 mm. Nastro retrattile 4-vie in poliestere nero lunghezza 2,13 metri, larghezza 4,8 cm. Base zavorrata ø 31 cm con gomma sotto la base. Peso 10 kg. Altezza totale 1 mt. Possibilità di applicare tabella segnaletica.



**Retractable belt stanchion, set 2 posts**

Aste delimita corsie nastro estensibile, set 2 pz

Absperrpfost mit einziehbarer Gurt, 2 Stk

Poteau avec ceinture rétractable, set 2 pcs

Poste con cinturón retráctil, 2 piezas

art.	Ø cm.	base Ø cm.	belt/nastro	h. cm.	Kg.
44183-01	6,3	36	cm 213x4,8	100	10

**Black laquered.** – Laccato nero.



**Retractable belt stanchion, set 2 posts**

Aste delimita corsie nastro estensibile, set 2 pz

Absperrpfost mit einziehbarer Gurt, 2 Stk

Poteau avec ceinture rétractable, set 2 pcs

Poste con cinturón retráctil, 2 piezas

art.	Ø cm.	base Ø cm.	belt/nastro	h. cm.	Kg.
44184-01	6,3	36	cm 213x4,8	100	10

**Stainless steel matt finish.** – Inox finitura satinata.



**Stanchion sign holder**

Tabella

Posterhalter

Porte-enseigne

Porta etiquetas

art.	dim. cm.
44183-A4	A4
44183-A3	A3

**Black laquered.** – Laccato nero.



**Stanchion sign holder**

Tabella

Posterhalter

Porte-enseigne

Porta etiquetas

art.	dim. cm.
44184-A4	A4
44184-A3	A3

**Stainless steel matt finish.** – Inox finitura satinata.



ROPE BARRIERS  
ASTE DELIMITA CORSIE

NEW



Tubular structure in polished or brass-plated stainless steel  $\varnothing$  6 cm. Eyelets for the attachment of the spring-hooks without direction constraint. Spring closure hooks in polished or brass-plated stainless steel. Twisted rope in synthetic material available in 4 colors, length 1 meter. Ballasted base  $\varnothing$  31 cm.

Struttura in tubolare di acciaio inox lucido o ottonato  $\varnothing$  6 cm. Anello per l'aggancio dei puntali senza vincolo di direzione. Puntali in acciaio inox lucido o ottonato. Treccia in materiale sintetico in 4 colori da 1 mt. Base zavorrata  $\varnothing$  31 cm.



**Stanchion**

Aste delimita corsie  
Kordel-Pfost  
Poteau de guidage  
Poste para cordón

art.	$\varnothing$ cm.	base $\varnothing$ cm.	h. cm.	Kg.	col.
44180-01	6	31	94	10	●
44181-01	6	31	94	10	●



**Spring closure hook**

Puntale con moschettone  
Karabiner mit Schnabberschluss  
Mousqueton pour cordon  
Terminación en gancho

art.	col.
44180-02	●
44181-02	●



**Twisted rope**

Cordone  
Kordel  
Corde tressé  
Cordón trenzado

art.	$\varnothing$ cm.	l. cm.	col.
44182-01	3	100	●
44182-02	3	100	●
44182-03	3	100	●
44182-04	3	100	●

Spring hook not included. – Puntale escluso.

# ELECTRIC APPLIANCES APPARECCHI ELETTRICI





**Dualit.**

**4 slot toaster**

Tostapane 4 fette  
Brotröster  
Grille pain  
Tostadora

art.	cm.	Kg.	kW
49801-04	36x21x22	4,25	2,2



**Dualit.**

**6 slot toaster**

Tostapane 6 fette  
Brotröster  
Grille pain  
Tostadora

art.	cm.	Kg.	kW
49801-06	46x21x22	5,1	3



**Dualit.**

**4 slice bun toaster**

Tostapane 4 fette  
Brotröster  
Grille pain  
Tostadora

art.	cm.	Kg.	kW
49802-04	36x21x22	4,52	1



**Dualit.**

**6 slice bun toaster**

Tostapane 6 fette  
Brotröster  
Grille pain  
Tostadora

art.	cm.	Kg.	kW
49802-06	46x21x22	5,52	1,5



**Conveyor Toaster**

Tostapane a nastro  
Durchlauf-Toaster  
Toaster convoyeur  
Tostador a túnel

art.	cm.	Kg.	kW
49803-02	37x64x40	20	2,8



**Conveyor toaster, CT540 B**

Tostapane a nastro doppia uscita  
Durchlauf toaster  
Toaster convoyeur  
Tostador a túnel

art.	cm.	Kg.	kW
49850-20	50x68x34,5	20	2,65



**Toaster, BAR 1000**

Tostapane  
Toast-/Überbackgerät  
Toaster  
Tostador de pan

art.	cm.	Kg.	kW
49850-65	45x28,5x30,5	10	2



**Toaster, BAR 2000**

Tostapane  
Toast-/Überbackgerät  
Toaster  
Tostador de pan

art.	cm.	Kg.	kW
49850-66	45x28,5x42	12	3



**Contact grill, SAVOYE**

Grill a contatto

Kontaktgrill

Grill à contact

Grill de contacto

art.	cm.	Kg.	kW
49850-22	33x38,5x22	18	2

**Contact grill, PANINI**

Grill a contatto

Kontaktgrill

Grill à contact

Grill de contacto

art.	cm.	Kg.	kW
49850-21	43x38,5x22	22,5	3

**Contact grill double plate, MAJESTIC**

Grill a contatto doppia piastra

Kontaktgrill, 2 Platten

Grill à contact, 2 plaques

Grill de contacto doble

art.	cm.	Kg.	kW
49850-23	60x38,5x22	33,5	2x2

**Contact sandwich toaster**

Grill a contatto

Sandwich-Toaster

Appareil croque monsieur

Grill de contacto

art.	cm.	Kg.	kW
49806-00	40x22x19	6	1,6

**Dualit.****Contact grill, PANINI XL**

Grill a contatto

Kontaktgrill

Grill à contact

Grill de contacto

art.	cm.	Kg.	kW
49850-19	41x62x34	32	3,6

**Glas ceramic contact grill, GVS 335**

Grill a contatto vetroceramica

Kontaktgrill, Glaskeramik-Platte

Grill à contact vitroc ramique

Grill de contacto vitrocer mica

art.	cm.	Kg.	kW
49850-18	39x60x26	14	3





**Salamander, SEM 600 PDS**

Salamandra  
Salamanders mit PDS  
Salamandre avec détection de plat  
Salamandra con PDS

art.	cm.	Kg.	kW
49850-71	60x64x59	56	3



**Hot dog heater, CS 3 E**

Scalda würstel  
Würstchenwärmer  
Chauffe-saucisses  
Calentador de salchichas

art.	cm.	Kg.	kW
49850-61	44x30x40	9	0,65



**Kebab/Gyros grill, GR 40 E**

Griglia kebab/gyros  
Elektro-Dönergrill  
Gril à kebab/gyros  
Asador de kebab/gyros

art.	cm.	Kg.	kW
49850-13	58x66x69,5	15	3,6

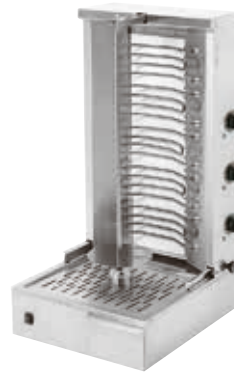

**Kebab/Gyros grill, GR 60 E**

Griglia kebab/gyros  
Elektro-Dönergrill  
Gril à kebab/gyros  
Asador de kebab/gyros

art.	cm.	Kg.	kW
49850-14	58x66x87	25	5,8

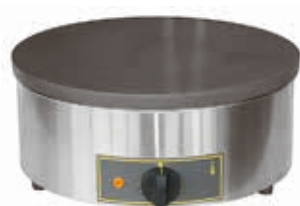

**Crepe machine, high-capacity, CFE 400**

Crepiera tonda, ad alto rendimento  
Crêpegerät  
Crêpière à haut rendement  
Crepera

art.	Ø cm.	h. cm.	Kg.	kW
49850-33	40	20	18	3,6



**Double crepe machine, CDE 400**

Crepiera doppia  
Crêpegerät, 2 Platten  
Crêpière double  
Crepera 2 placas

art.	Ø cm.	cm.	Kg.	kW
49850-11	40	45x50x24	23	3,6





**Single crepe machine, CSE 400**

Crepiera singola  
Crêpegerät  
Crêpière simple  
Crepera

art.	Ø cm.	cm.	Kg.	kW
49850-12	40	86x50x24	44	3,6x2



**Eggs boiler, CO 60**

Bollitore uova  
Eierkocher  
Cuisseur à oeuf  
Caldera para huevos

art.	cm.	Kg.	kW
49850-36	21,5x43x25,5	4,5	1,2



**Multifunction oven, FC 280**

Forno multifunzione  
Multifunktionsofen  
Four multifonctions  
Horno multifunción

art.	cm.	Kg.	kW
49850-73	46x55x35,5	20	1,5



**Multifunction oven, FC 380 TQ**

Forno multifunzione  
Multifunktionsofen  
Four multifonctions  
Horno multifunción

art.	cm.	Kg.	kW
49850-75	55x55x35,5	22	2,4



**Multifunction oven, FC 60 TQ**

Forno multifunzione  
Multifunktionsofen  
Four multifonctions  
Horno multifunción

art.	cm.	Kg.	kW
49850-76	59,5x61x59	38	3



**Fryer, FD 80 R**

Friggitrice  
Fritteuse  
Friteuse  
Freidora

art.	cm.	kg./H	Kg.	kW
49850-41	26,5x45x36	15	8	3,6



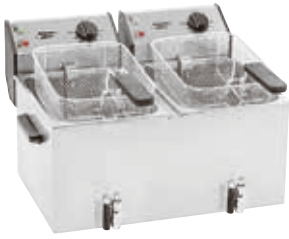

**Fryer, FD 80 DR**

Friggitrice  
Fritteuse  
Friteuse  
Freidora

art.	cm.	kg./H	Kg.	kW
49850-42	59x45x37	30	15	2x3,6



**Fryer, FD 50**

Friggitrice  
Fritteuse  
Friteuse  
Freidora

art.	cm.	kg./H	Kg.	kW
49850-37	21,5x42,5x32	10	5	3,2



**Fryer, FD 50 D**

Friggitrice  
Fritteuse  
Friteuse  
Freidora

art.	cm.	kg./H	Kg.	kW
49850-39	39x42,5x32	20	10	2x3,2



**Dish-warmer, DW106 / 110**

Scaldapiatti  
Rechaud  
Chauffe plats  
Calentador de platos

art.	cm.	Kg.	kW
49850-06	40x21,5x33,5	14	0,65
49850-10	40x21,5x47,5	25	1,3



**Ventilated warming display, WD 780 SI**

Espositore caldo ventilato  
Konvektion-Warme Theke  
Présentoir chaud à convection  
Expositor caliente con convección

art.	cm.	Kg.	kW
49850-69	78x49x48	30	1,2



**Ventilated warming display, WD 780 DI**

Espositore caldo ventilato  
Konvektion-Warme Theke  
Présentoir chaud à convection  
Expositor caliente con convección

art.	cm.	Kg.	kW
49850-70	78x49x64	35	1,8

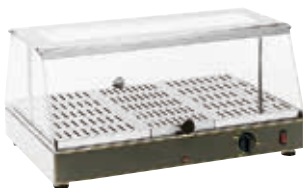

**Warming display**

Vetrina riscaldata  
Warmhalte-Vitrine  
Vitrine chauffante  
Vitrina caliente

art.	GN	cm.	Kg.	kW	range
49850-43	1/1	59x35x28,5	12	0,65	+20 +95°C



**Warming display**

Vetrina riscaldata  
Warmhalte-Vitrine  
Vitrine chauffante  
Vitrina caliente

art.	GN	cm.	Kg.	kW	range
49850-44	2x 1/1	59x35x39	15	0,65	+20 +95°C



**Tapas display**

Vetrina antipasti

Vorspeisen-Schaufenster

Vitrine tapas

Vitrina para tapas

art.	cm.	Kg.	W	range
49630-06	145x40x26	33	160	+2/+5°C
49630-08	180x40x26	40	160	+2/+5°C

**Ice cream maker**

Macchina per gelato

Eismaschine

Machine à glace

Maquinas helado

art.	cm.	lt.	kg./H	Kg.	kW
49949-19	51x31x35	1,5	3	30	0,4

**Dehydrator for fruits and vegetables**

Disidratatore per frutta e verdura

Dehydratisierapparat

Déshydrateur fruits et légumes

Deshidratador de frutas y verduras

art.	cm.	Kg.	kW	range
49953-02	43,5x29x21	3,6	0,53	+30 +80°C

**Supplied with 6 reversible trays. Timer up to 72 hours.**

6 vassoi reversibili. Timer fino a 72 ore.

**Smoker, 2 levels**

Affumicatoio a 2 piani

Räucherofen

Fumoir

Ahumador

art.	cm.	Kg.	kW
49850-63	45x45x35	25	1,5

**Table-top cutter**

Cutter da tavolo

Gemüseschneidmaschine

Cutter à légumes

Cortador verduras

art.	cm.	lt.	Kg.
49979-03	32x52x62	3	12

**Electric peeler**

Pelatrice elettrica

Elektr. Schälmachine

Eplucheur électrique

Pelador eléctrico

art.	cm.	Kg.
49750-00	25x16x21,5	2





**Dualit.**

**Waffle iron**

Macchina per cialde  
Waffeleisen  
Gufrier  
Gofrera

art.	cm.	Kg.	kW
49809-00	40x22x19	5,5	1,6



**Single waffle iron, GESIMPLE**

Macchina per cialde  
Waffeleisen mit 1 Platte  
Gaufrier simple  
Gofrera singular

art.	cm.	Kg.	kW
49850-24	30,5x44x23	22	1,6
49850-25	30,5x44x23	22	1,6
49850-26	30,5x44x23	22	1,6
49850-27	30,5x44x23	22	1,6



**Double waffle iron, GESDOUBLE**

Macchina per cialde doppia  
Waffeleisen mit 2 Platten  
Gaufrier double  
Gofrera doble

art.	cm.	Kg.	kW
49850-28	55x44x23	38	3,2
49850-29	55x44x23	38	3,2
49850-30	55x44x23	38	3,2
49850-31	55x44x23	38	3,2



-24 / -28



-25 / -29



-26 / -30



-27 / -31



**Single waffle iron, GES23**

Macchina per cialde  
Waffeleisen mit 1 Platte  
Gaufrier simple  
Gofrera singular

art.	cm.	Kg.	kW
49850-03	30,5x44x23	22	1,6



SS

**Infrared lamp with warming plate**

Lampada ad infrarossi con piano caldo  
Infrarot Wärmebrücke mit Wärmeplatte  
Lampe infrarouge avec plaque chauffante  
Lámpara infrarrojos y placa caliente

art.	GN	cm.	kW
49993-21	1/1	38x53x70	0,5
49993-22	2/1	70x53x71	1,0
49993-23	3/1	103x53x70	1,5

**Curved plexiglass fender. Separate switches for plate and lamps. Adjustable thermostat +30°C +90°C.** – Parafiato in plexiglass curvo. Interruttori di accensione separati per piano caldo e lampade. Termostato regolabile +30°C +90°C.



SS

**Infrared lamp**

Lampada ad infrarossi  
Infrarot Wärmebrücke  
Lampe infrarouge  
Lámpara infrarrojos

art.	GN	cm.	kW
49993-01	1/1	38x53x70	0,25
49993-02	2/1	70x53x71	0,50
49993-03	3/1	103x53x70	0,75

**Curved plexiglass fender.** – Parafiato in plexiglass curvo.



SS

**Warming plate**

Piano caldo  
Wärmeplatte  
Plaque chauffante  
Placa caliente

art.	GN	cm.	kW
49993-11	1/1	33x53x6	0,25
49993-12	2/1	66x53x6	0,50
49993-13	3/1	132x53x6	0,75

**Adjustable thermostat +30°C +90°C.** – Termostato regolabile +30°C +90°C.



SS

**Table with hot box**

Tavolino con box termico  
Tisch mit Hot Box  
Table avec hot box  
Carrito con hot box

art.	Ø cm.	h. cm.	W
44094-02	90/54,6	77	500

**Table with fold down flaps.** – Tavolo con flaps pieghevoli.





SS

**Table with hot box**

Tavolino con box termico  
Tisch mit Hot Box  
Table avec hot box  
Carrito con hot box

art.	Ø cm.	h. cm.	W
44094-04	90/54,6	78,6	500

**Table with fold down flaps. With capsizable top for stacking when not in use.**  
Tavolo con flaps pieghevoli. Ribaltabile e impilabile quando non in uso.



SS

**Table with hot box**

Tavolino con box termico  
Tisch mit Hot Box  
Table avec hot box  
Carrito con hot box

art.	Ø cm.	h. cm.	W
44094-06	90/73	76	500

**Table with fold down flaps. Foldable for saving space when not in use. – Tavolo con flaps pieghevoli. Pieghevole per ridurre l'ingombro quando non in uso.**



**Mixer/liquidiser combi unit**

Combi mixer/frusta  
Kombigerät  
Combiné mixeur-fouet  
Brazo triturador/batidor, unidad combinada

art.	h. cm.	Kg.	kW	rpm
49907-01	79	4,95	0,35	15000

**For containers up to 100 liters. – Per contenitori fino a 100 litri.**



**Liquidiser**

Mixer  
Stabmixer  
Mixeur  
Brazo triturador

art.	h. cm.	Kg.	kW	rpm
49907-06	55,5	1,45	0,25	15000

**For containers up to 30 liters. – Per contenitori fino a 30 litri.**



**Wall rack**

Supporto murale  
Wandständer  
Support mural  
Soporte mural

art.
49907-AA



**Liquidiser**

Mixer  
Stabmixer  
Mixeur  
Brazo triturador

art.	Kg.	kW	rpm
49807-00	1	0,2	0-13000





**Mini mixer**  
Mini mixer  
Mini-Stabmixer  
Mini mixeur  
Mini batidora

art.	h. cm.	Kg.	kW	rpm
49808-00	40	0,78	0,45	12500:14000



**Liquidiser**  
Mixer  
Stabmixer  
Mixeur  
Brazo triturador

art.	h. cm.	Kg.	kW	rpm
49911-24	24	1,4	0,27	2000:12500
49916-25	25	3,0	0,27	2300:9600
49916-35	35	3,3	0,35	2300:9600
49916-45	45	4,9	0,44	1500:9000
49916-55	55	5,2	0,75	9000



**Mixer/liquidiser combi unit**  
Combi mixer/frusta  
Kombigerät  
Combiné mixeur-fouet  
Brazo triturador/batidor, unidad combinada

art.	h. cm.	Kg.	kW	rpm
49911-19	19	1,9	0,25	2000:12500
49911-30	30	3,1	0,30	2300:9600
49911-35	35	5,9	0,44	1500:9000
49911-45	45	6,1	0,50	1500:9000



**Juice extractor J80 Ultra**  
Centrifuga  
Fruchtpresse  
Centrifugeur-presse agrumes  
Centrifugadora/exprimidor jugos

art.	cm.	kg./H	Kg.	kW	rpm
49949-20	23,5x42x50,5	60	11	0,7	3000



**Vegetable preparation machine CL 50 Ultra**  
Tagliaverdure  
Gemüseschneidmaschine  
Coupe-légumes  
Cortador verduras

art.	cm.	Kg.	kW	rpm
49940-01	30x36x55,5	15	0,55	375

**Suitable also for cutting mozzarella. For cutting discs contact our customer service.** – Ideale anche per tagliare mozzarella. Per i dischi di taglio contatta il ns customer service.



**Cutter & vegetable slicer R301 Ultra**  
Combinato cutter/tagliaverdure  
Gemüseschneid/- u. Schälmaschine  
Cutter/Coupe-légumes  
Cortador verduras

art.	cm.	lt.	Kg.	kW	rpm
49942-01	28,5x36x40	3,7	14	0,65	1500

**For cutting discs contact our customer service.** Per i dischi di taglio contatta il ns customer service.





**Cutter & vegetable slicer R502 VV**

Combinato cutter/tagliaverdure  
Gemüseschneid/- u. Schälmaschine  
Cutter/Coupe-légumes  
Cortador verduras

art.	cm.	lt.	Kg.	kW	rpm
49942-03	35,5x30x65,5	5,5	30	1,3	300-3500

**For cutting discs contact our customer service.**  
Per i dischi di taglio contatta il ns customer service.



**Table-top cutter R4**

Cutter da tavolo  
Gemüseschneidmaschine  
Cutter à légumes  
Cortador verduras

art.	cm.	lt.	Kg.	kW	rpm
49943-01	21x32x43	4,5	17	0,9	1500/3000



**Table-top cutter R5 plus**

Cutter da tavolo  
Gemüseschneidmaschine  
Cutter à légumes  
Cortador verduras

art.	cm.	lt.	Kg.	kW	rpm
49943-02	28x34x48	5,5	24	1,2	1500/3000



**Emulsifier-mixer Blixer 4**

Omogeneizzatore  
Mixergerät  
Emulsionneur-mixer  
Omogenizador/emulsificador

art.	cm.	lt.	Kg.	kW	rpm
49944-01	46x22,5x30,5	4,5	18	1	1500/3000



**Emulsifier-mixer Blixer 4 VV**

Omogeneizzatore  
Mixergerät  
Emulsionneur-mixer  
Omogenizador/emulsificador

art.	cm.	lt.	Kg.	kW	rpm
49944-02	46x22,5x30,5	4,5	18	1,1	300-3500



**Sieving juicer C80**

Centrifuga  
Passiermaschine  
Centrifugeuse  
Centrifugadora

art.	cm.	kg./H	Kg.	kW	rpm
49946-01	61x36x54	50	21	0,65	1500



**Citrus fruit squeezer**

Spremiagrumi  
Zitruspresse  
Presse agrumes  
Exprimidor cítricos

art.	cm.	Kg.	kW	rpm
49922-01	20x30x35	5	0,13	1500

**Citrus fruit squeezer**

Spremiagrumi  
Zitruspresse  
Presse agrumes  
Exprimidor cítricos

art.	cm.	Kg.	kW	rpm
49922-02	20,5x30,5x49	10	0,23	1500-1800

**Citrus fruit squeezer**

Spremiagrumi  
Zitruspresse  
Presse agrumes  
Exprimidor cítricos

art.	cm.	Kg.	kW	rpm
49922-03	20x30x38	10	0,23	1500-1800

**Citrus fruit squeezer**

Spremiagrumi  
Zitruspresse  
Presse agrumes  
Exprimidor cítricos

art.	cm.	Kg.	kW	rpm
49922-04	24x40x49	10	0,275	1500-1800

**Juice extractor**

Centrifuga, spremisucchi  
Fruchtpresse  
Centrifugeur-presse agrumes  
Centrifugadora/exprimidor jugos

art.	cm.	Kg.	kW	rpm
49922-06	26x47x45	16	0,8	3000-3300





**Ice crusher**

Spaccaggiaccio  
Eiszerstosser  
Broyeur à glace  
Triturador de hielo

art.	cm.	Kg.	kW	rpm
49922-08	24x35x47	10	0,13	73-89



**Drink Mixer**

Frullino  
Getränkemixer  
Shaker électrique  
Batidora para batidos

art.	cm.	Kg.	kW	rpm
49949-09	18x18x53	6	0,12	8000-16000



**Blender**

Frullatore  
Getränkemixer  
Mixeur  
Batidora de vaso

art.	cm.	lt.	Kg.	kW	rpm
49922-22	30x22x56,6	2	11	1,2	500-15000
49922-23	30x22x56,6	4	11	1,2	500-15000

**Stainless steel bowl. – Bicchiere inox.**



**BPA FREE**

**Blender**

Frullatore  
Getränkemixer  
Mixeur  
Batidora de vaso

art.	cm.	lt.	Kg.	kW	rpm
49922-20	30x22x56,6	2	11	1,2	500-15000
49922-21	30x22x56,6	4	11	1,2	500-15000

**Clear bowl BPA Free. – Bicchiere trasparente BPA Free.**



**BPA FREE**

**Blender**

Frullatore  
Getränkemixer  
Mixeur  
Batidora de vaso

art.	cm.	Kg.	kW
49922-09	20x47x44	9	3

**Clear bowl BPA Free. – Bicchiere trasparente BPA Free.**



**Citrus fruit squeezer**

Spremiagrumi  
Zitruspresse mit Spritzschutz  
Presse agrumes  
Exprimidora

art.	cm.	Kg.	kW	rpm
49958-00	31x22x34	8	0,3	1400



**Lever citrus fruit squeezer**

Spremiagrumi a leva  
 Zitruspresse mit Pressarm  
 Presse agrumes à levier  
 Exprimidora

art.	cm.	Kg.	kW	rpm
49959-00	31x22x35	9	0,34	1400

**Blender**

Frullatore  
 Getränkemixer  
 Mixeur  
 Batidora de vaso

art.	cm.	lt.	Kg.	kW	rpm
49956-01	20x20x46	1,7	4	0,4	10000:15000

**Plastic bowl. – Bicchieri plastica.**

**Blender**

Frullatore  
 Getränkemixer  
 Mixeur  
 Batidora de vaso

art.	cm.	lt.	Kg.	kW	rpm
49957-00	23x23x52	3	5,5	1	12000:22000

**Stainless steel bowl. – Bicchiere inox.**

**Automatic ice crusher**

Tritagiaccio automatico  
 Eiszerstosser  
 Broyeur à glace  
 Triturador de hielo automatico

art.	cm.	Kg.	kW	rpm
49960-00	42x21x29	11	0,34	1400

**Drink mixer**

Frullino  
 Getränkemixer  
 Shaker électrique  
 Batidora para batidos

art.	cm.	lt.	Kg.	kW	rpm
49955-01	20x22x50	0,8	2,8	0,12	15000

**Plastic bowl. – Bicchieri plastica.**

**Rice steamer**

Cuoci riso a vapore  
 Reiskocher  
 Cuit riz  
 Hervidor de arroz

art.	Ø cm.	h. cm.	lt.	kW
49954-21	5,0	35	21	3





SS

**Steamer**

Vaporiera  
Dampfer  
Cuit vapeur  
Olla para cocinar al vapor

art.	Ø cm.	h. cm.	lt.	kW
49954-18	3,8	46	15	2



SS

**Water boiler**

Bollitore per acqua  
Wasser-Kessel  
Chaufe-eau  
Caldera

art.	Ø cm.	h. cm.	lt.	Kg.	kW
49954-20	4,7	48	20	5,7	2,1



**Planetary mixer**

Impastatrice planetaria  
Knet- u. Schlagmaschine  
Batteur-mélangeur  
Batodira planetaria

art.	cm.	lt.	Kg.	kW	rpm
49947-08	30x40x58	7,6	27	0,18	1420

**3 speeds. Timer 0-15 min. – 3 velocità. Timer 0-15 min.**



**Planetary mixer**

Impastatrice planetaria  
Knet- u. Schlagmaschine  
Batteur-mélangeur  
Batodira planetaria

art.	cm.	lt.	Kg.	kW	rpm
49945-05	38x31x45,5	5	15	0,75	40>260

**10 speeds. – 10 velocità.**



SS

**Microwave oven - PROG**

Forno microonde  
Mikrowelle  
Four à micro-ondes  
Microonda

art.	cm.	lt.	Kg.	kW
49997-12	54,2x46,1x32,9	30	18	1,6

**5 power levels. Time key X2. Digital timer. 3 cooking stages, 5 power levels. 10 programmable keys. 20 programs. – 5 livelli di potenza, da 200 a 1000W. Tasto tempo X2. Timer digitale. 3 stadi cottura e 5 livelli di potenza. 10 tasti programmabili. 20 programmi.**



SS

**Microwave oven - SELF**

Forno microonde  
Mikrowelle  
Four à micro-ondes  
Microonda

art.	cm.	lt.	Kg.	kW
49997-13	54,2x46,1x32,9	30	18	1,6

**Time key X2. Digital timer. "START" button preprogrammed "1 minute" at full power. Parameters customizable. – Tasto tempo X2. Timer digitale. Tasto "START" pre-programmato "1 minuto" a piena potenza. Parametri pre-impostati personalizzabili.**



**Sous-vide cooking device**

Apparecchio per cottura sottovuoto

Sous-Vide Garer

Cuiseur bain marie - sous vide

Equipo para cocinar al vacío

art.	cm.	lt.	Kg.	kW
49954-22	36x29,2x29	11	5,9	0,85

**Cooks food in vacuum-sealed pouches submerged in a water bath held at a precisely-controlled temperature from 30°C to 100°C.** – Per cuocere a bagnomaria in buste sottovuoto. La temperatura è mantenuta precisamente costante e può essere regolata da 30°C a 100°C.

**Sous-vide water bath**

Apparecchio per cottura sottovuoto

Sous-Vide Garer

Cuiseur bain marie - sous vide

Equipo para cocinar al vacío

art.	cm.	lt.	Kg.	kW
49952-08	22x25x38	8	4	0,8

**LED touch screen controls. The temperature can be set between 30 and 90°C and time between 0 and 99 hours. Stainless steel lid and wire rack included.** Controlli touchscreen a LED. La temperatura può essere impostata tra 30 e 90°C, tempo tra 0 e 99 ore. Coperchio e griglia in acciaio inossidabile inclusi.

**Soft cooker**

Apparecchio per cottura sottovuoto

Sous-Vide-Garer

Thermoplongeur

Máquina para cocinar al vacío

art.	cm.	Kg.	kW
49851-10	16,4x22x41,5	8	0,2

**Stainless steel structure. Suitable for containers up to 60 liters. Min. height of the tank 180 mm, electronic temperature control with 1/10°C precision, adjustable temperature 0>95°C. Pump for water circulation. Acoustic timer. Possibility to memorize up to 20 programs. Level sensor for lack of water.**

Struttura in acciaio inox. Per recipienti fino a 60 litri. Altezza minima del recipiente 180 mm, controllo elettronico della temperatura con precisione al 1/10°C, temperatura regolabile 0>95°C. Pompa per la circolazione dell'acqua. Timer acustico. Possibilità di memorizzare fino a 20 programmi. Sensore di livello per mancanza acqua.





**Induction cooker TC 3500**

Piastra ad induzione  
Induktionsplatte  
Plaque à induction  
Placa de inducción

art.	cm.	Kg.	kW
49998-35	35,5x46x11	5,5	3,5

**Stainless steel body, Schott Ceran surface. Thermocontrol. 12 power levels. Temperature preselection 60-240°C. Timer 23 hours 59 min.**  
Corpo in acciaio inox, piano Schott Ceran. Thermocontrol. 12 livelli di potenza. Preselezione temperatura 60-240°C. Timer 23 ore 59'.



**Induction cooker**

Piastra ad induzione  
Induktionsplatte  
Plaque à induction  
Placa de inducción

art.	cm.	Kg.	kW
18162-RA	30x37x10	6	2,7

**Stainless steel body, Schott ceran surface. Timer 0-180 min. 10 power levels. Temperature range 60-240°C.** – Corpo inox, piano Schott ceran. Timer 0-180 min. 10 livelli di potenza. Temperatura 60-240°C.



**Induction cooker, to be built into counter**

Piastra ad induzione, da incasso  
Induktionsplatte, thekereinbau  
Plaque à induction, montage an comptoir  
Placa de inducción para emportar

art.	cm.	Kg.	kW
18162-RB	36X38x12,5	5,7	3,5

**Schott ceran surface. Timer 0-180 min. 10 power levels. Temperature range 60-240°C.** – Piano Schott ceran. Timer 0-180 min. 10 livelli di potenza. Temperatura 60-240°C.



**Induction cooker, to be built into counter**

Piastra ad induzione, da incasso  
Induktionsplatte, thekereinbau  
Plaque à induction, montage an comptoir  
Placa de inducción para emportar

art.	cm.	Kg.	kW
49998-20	35,5x35,5x6	3,4	2

**Schott ceran surface. 5 power levels. Temperature range 60-240°C.**  
Piano Schott ceran. 5 livelli di potenza. Temperatura 60-240°C.



SS

**Coffee percolator**

Percolatore per caffè  
Kaffee-Perkolator  
Percolateur à café  
Percolator de café

art.	Ø cm.	h. cm.	lt.	W
49846-05	28	38,5	4,5	950
49846-09	28	38,5	9,2	950
49846-15	33	54,0	15,0	1650



NEW

SS

**Samovar PYRAMID**

Samovar  
Samovar  
Samovar  
Samovar

art.	cm.	lt.	W
49856-04	35,5x30x45,2	4+1,2	2500

**Teapot with strainer. Cable length approx. 130 cm. With 2 heating elements 2000W and 500W.** – Teiera con colino. Lunghezza cavo circa 130 cm. Con 2 resistenze 2000W e 500W.



NEW

SS

**Samovar 2017**

Samovar  
Samovar  
Samovar  
Samovar

art.	cm.	lt.	W
49854-03	31x27,5x48,5	3+1,2	1500

**Teapot with strainer, cable length approx. 130 cm.**  
Teiera con colino. Lunghezza cavo circa 130 cm.



NEW

SS

**Samovar ROMANOV**

Samovar  
Samovar  
Samovar  
Samovar

art.	cm.	lt.	W
49855-05	34x27x59	5+1,3	1800

**Teapot with strainer. Cable length approx. 100 cm. With 2 heating elements 1300W and 500W.** – Teiera con colino. Lunghezza cavo circa 100 cm. Con 2 resistenze 1300W e 500W.



NEW

SS

**Samovar 3006C**

Samovar  
Samovar  
Samovar  
Samovar

art.	cm.	lt.	W
49854-06	35,5x30x45,2	6+1,5	2500

**Teapot with strainer. With 2 heating elements 2000W and 500W.**  
Teiera con colino. Con 2 resistenze 2000W e 500W.



NEW

SS

**Samovar SORAYA**

Samovar  
Samovar  
Samovar  
Samovar

art.	cm.	lt.	W
49855-10	35,2x44,5x69	10+1,6	3000

**Teapot with strainer. Cable length approx. 130 cm. With 2 heating elements 2300W and 700W.** – Teiera con colino. Lunghezza cavo circa 130 cm. Con 2 resistenze 2300W e 700W.



NEW

SS

**Samovar KATHARINA**

Samovar  
Samovar  
Samovar  
Samovar

art.	cm.	lt.	W
49855-15	39,5x44,5x74,5	15+2	3000

**Teapot with strainer. Cable length approx. 130 cm. With 2 heating elements 2300W and 700W.** – Teiera con colino. Lunghezza cavo circa 130 cm. Con 2 resistenze 2300W e 700W.



NEW

SS

**Chocolate fountain**

Fontana cioccolato  
Schokoladenbrunnen  
Fontaine à chocolat  
Fuente para chocolate

art.	Ø cm.	h. cm.	lt.	W
42982-08	38	80	3,5	370

**230V-50Hz-Amps 1,6A. Minimum quantity of chocolate necessary for operation is about 3.5 kg, the maximum is 8 kg.** – Quantità minima di cioccolata richiesta per funzionare è di circa 3,5 kg e può contenerne fino a 8 kg.





**Soup kettle**

Zuppiera  
Suppenwärmer  
Marmite à soupe  
Olla de sopa

art.	Ø cm.	h. cm.	lt.	W
49847-38	38	36,5	10	450-550



**Soup kettle**

Zuppiera  
Suppenwärmer  
Marmite à soupe  
Olla de sopa

art.	Ø cm.	h. cm.	lt.	W
49847-08	33	37	10	400



**Raclette maker**

Macchina per raclette  
Raclette Tischgerät  
Appareil à raclette  
Máquina raclette

art.	cm.	W
42420-06	44,5x21,5x30	850

**Foldable model with transport hook. 2 heating ramps, adjustable height. Suitable for cheese size 1/6 to 1/3 of a wheel. In stainless steel and painted steel. – Modello pieghevole con gancio di trasporto. 2 rampe di riscaldamento, altezza regolabile. Adatto per formaggi da 1/6 a 1/3 di una forma. In acciaio inossidabile e acciaio verniciato.**



**Raclette maker**

Macchina per raclette  
Raclette Tischgerät  
Appareil à raclette  
Máquina raclette

art.	cm.	W
42420-08	44,5x21,5x30	850

**Tiltable and easily removable cheese holder. Heating block adjustable height. Ideal for 6-8 people, 1/2 shape. Cheese holder in stainless steel and epoxy painted steel structure. – Porta formaggio inclinabile e facilmente rimovibile. Blocco riscaldante regolabile in altezza. Ideale per 6-8 persone, 1/2 forma. Porta formaggio in acciaio inossidabile e struttura in acciaio verniciato epossidico.**



**Raclette maker, 4 pans**

Macchina per raclette, 4 padelle  
Raclette Tischgerät, 4 Pfannen  
Appareil à raclette, 4 poêlons  
Máquina raclette

art.	cm.	W
41318-00	51x10x12	600

**Non-stick upper plate for all cooking (vegetables, meats, etc.). Piastra superiore antiaderente per tutte le cotture (verdure, carne, ecc.).**



**Sugar lamp**

Lampada per zucchero  
Zuckerlampe  
Lampe à sucre  
Lámpara para azúcar

art.	cm.	Kg.
47840-11	61x41x50	6,4

**Stainless steel. Infrared lamp, 3 selection powers 500-1000-1500W. Cable included. – Acciaio inox. Lampada infrarossi con 3 potenze selezionabili, 500-1000-1500W. Incl. cavo di alimentazione.**



**Spray gun**

Pistola  
Sprühpistole  
Pistolet  
Pistola

art.	ml.	Kg.	W	rpm
47848-07	700	1,1	60	280

**Usable for hot liquids max. 65 °C. Equipped with nozzle 0,6 mm.**  
Per liquidi caldi max. 65°C. Bocchetta in dotazione da 0,6 mm.



**NEW**  
**ABS**

**Tempering unit**

Temperatrice  
Temperiergerät  
Tempereuse  
Templadora

art.	Ø cm.	h. cm.	lt.
47698-01	20,5	21,2	1,7

**For ice cream parlours, ideal for chocolate coatings of ice creams on sticks. Can be used straight on the counter. Removable anodized aluminum tank.**  
Per gelaterie, ideale per coperture in cioccolato di gelati e semifreddi su stecco. Può essere utilizzato direttamente sul banco. Vasca estraibile in alluminio anodizzato.



**NEW**  
**ABS**

**Tempering unit**

Temperatrice  
Temperiergerät  
Tempereuse  
Templadora

art.	Ø cm.	h. cm.	lt.
47698-02	26	16	1,8

**Mini dry melter, allows to process tiny chocolate quantities without any waste. Practical removable tank.** – Mini scioglitore a secco, adatto per piccole produzioni senza sprechi. Pratica vasca estraibile.



**SS**  
**ABS**

**Tempering unit**

Temperatrice  
Temperiergerät  
Tempereuse  
Templadora

art.	cm.	lt.
47698-03	40x24x13,5	3,6
47698-06	40x33x13,5	6,0

**Analog tempering units. Housing made with heat-resistant plastic. Removable stainless steel tank. UK/US/JAPAN/AUSTRALIA/CHINA wirings upon request.**  
Temperatrici analogiche. In materiale plastico termoresistente. Vasca inox removibile. Su richiesta cablaggio GB/USA/GIAPPONE/AUSTRALIA/CINA.



**NEW**  
**SS**  
**ABS**

**Tempering unit, digital**

Temperatrice digitale  
Temperiergerät, digital  
Tempereuse digitale  
Templadora digital

art.	cm.	lt.
47698-07	40x33x13,5	6,0

**Made of heat-resistant plastic material, stainless steel tank and lid, thermal probe for chocolate temperature control. Tempering manually adjustable or following the 3 programs depending on the type of chocolate: white, milk and dark.** – In materiale plastico termoresistente, vasca e coperchio in acciaio inox, sonda termica per la regolazione della temperatura del cioccolato. Temperaggio regolabile manualmente o seguendo i 3 programmi in base al tipo di cioccolato: bianco, al latte e fondente.

**Airbrush compressor**

Compressore per penna aerografa  
Airbrush Kompressor  
Compresseur  
Compresor

art.	cm.	W
47844-06	16x30x23	200

**Cap. 4 bar.**





**Caramelizer**

Caramellizzatore  
Caramelisateur  
Carameliser-Eisen  
Carameliseur  
Quemador

art.	Ø cm.	W
47847-10	10	0,65
47847-12	12	1,00



**Caramelizer**

Caramellizzatore  
Caramelisateur  
Carameliser-Eisen  
Carameliseur  
Quemador

art.	l. cm.	W
47847-23	23	1,5



**Meat mincer**

Tritacarne  
Fleischwolf  
Hachoir  
Tritador de carne

art.	cm.	Kg.	kW
49921-00	18x42x43	6	0,35



**Slicer**

Affettatrice  
Aufschnitt-Maschine  
Trancheur  
Cortadora

art.	Ø cm.	cm.	Kg.	rpm
49975-19	19,5	52x36x31,5	10	300
49975U19*	19,5	52x36x31,5	10	300

\*Extra CE. Built-in blade sharpener. – Extra CE. Affilatoio fisso.



**Slicer**

Affettatrice  
Aufschnitt-Maschine  
Trancheur  
Cortadora

art.	Ø cm.	cm.	Kg.	rpm
49975-25	25	62x42,5x37	15,5	300
49975U25*	25	62x42,5x37	15,5	300

\*Extra CE. Built-in blade sharpener. – Extra CE. Affilatoio fisso.



**Slicer**

Affettatrice  
Aufschnitt-Maschine  
Trancheur  
Cortadora

art.	Ø cm.	cm.	Kg.	rpm
49975-22	22	58x40,5x34	10	300
49975U22*	22	58x40,5x34	10	300

\*Extra CE. Built-in blade sharpener. – Extra CE. Affilatoio fisso.







**Slicer**  
Affettatrice  
Aufschnitt-Maschine  
Trancheur  
Cortadora

art.	Ø cm.	cm.	Kg.	rpm
49975-30	30	65x49,5x44	23	300
49975U30*	30	65x49,5x44	23	300

\*Extra CE. Built-in blade sharpener. – Extra CE. Affilatoio fisso.



**Slicer**  
Affettatrice  
Aufschnitt-Maschine  
Trancheur  
Cortadora

art.	Ø cm.	cm.	Kg.	rpm
49975-35	35	89x58,5x48	36	260
49975U35*	35	89x58,5x48	36	260

\*Extra CE. Built-in blade sharpener. – Extra CE. Affilatoio fisso.

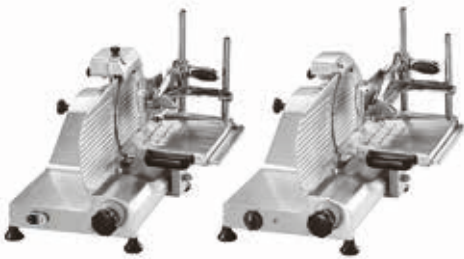

**Slicer**  
Affettatrice  
Aufschnitt-Maschine  
Trancheur  
Cortadora

art.	Ø cm.	cm.	Kg.	rpm
49974-25	25	53x52x50	24	300
49974U25*	25	53x52x50	24	300

\*Extra CE. – Extra CE.



**Slicer**  
Affettatrice  
Aufschnitt-Maschine  
Trancheur  
Cortadora

art.	Ø cm.	cm.	Kg.	rpm
49974-30	30	53x52x50	27	300
49974U30*	30	53x52x50	27	300

\*Extra CE. – Extra CE.





SS

**Sieve**

Passaverdura  
Passiergerät  
Moulin  
Molino

art.	Ø cm.	h. cm.	kg./H	Kg.	W
49879-37	37	108	300	23,5	600

**Threephase motor 380V. Disc 3 mm. – Motore trifase 380V. Griglia 3 mm.**



SS

**Can opener**

Apriscatole  
Dosenöffner  
Ouvre-boîte  
Abrelatas

art.	cm.	Kg.
49814-00	44x25x75	13

**Dual speed motor. Opens all can shapes from 50 to 270 mm height. Motore a 2 velocità. Per formati scatola da 50 a 270 mm di altezza.**



SS

**Knife sterilizer**

Sterilizzatore per coltelli  
Messerentkeimer  
Armoire de sterilisation  
Esterilizador para cuchillos

art.	cm.	W
49871-10	57,5x17x60	15

**Plexiglas door, magnetic lock. Timer setting from 0 up to 2 hours. Door with stop device when opening. Protection IP 24.**

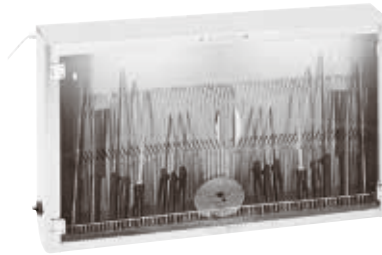

SS

**Knife sterilizer**

Sterilizzatore per coltelli  
Messerentkeimer  
Armoire de sterilisation  
Esterilizador para cuchillos

art.	cm.	W
49871-20	103x17x60	30

**Porta in plexiglas, chiusura magnetica. Programmabile da 0 a 2 ore. Dispositivo d'arresto all'apertura porta. Indice di protezione IP 24.**



**E**dlund

**Knife sharpener**

Affilacoltelli  
Messerschleifapparat  
Aiguiseur  
Afilador

art.	cm.	Kg.	W	rpm
49872-00	25x10x12	4	172	1550

**ABS knife guide. Pressure sensitive motor shuts down automatically. Guida in ABS estraibile. Motore con dispositivo autobloccante.**



**Knife sharpener**

Affilacoltelli  
Messerschleifapparat  
Aiguiseur  
Afilador

art.	cm.	Kg.
49741-15	23x33x16	6,4
49741-07	23x16x16	4,6



# CUCINA SENZA GLUTINE

FOR GLUTEN-FREE COOKING



UNA LINEA COMPLETA DI ARTICOLI E STRUMENTI  
PROFESSIONALI FACILMENTE IDENTIFICABILI PER:

- diminuire il rischio di accidentali contaminazioni crociate degli alimenti;
- facilitare il professionista nell'operare e nell'offrire un servizio a favore del cliente con intolleranza al glutine;
- sensibilizzare il settore sul tema "gluten free" di fronte alle nuove esigenze dei consumatori.

A FULL LINE OF HORECA TOOLS AND ITEMS,  
EASY TO IDENTIFY, AIMED AT:

- reducing the risk of accidental food cross-contamination;
- making it easier for professionals to work and to provide services to clients with gluten intolerance;
- raising awareness on the gluten-free diet issue in the industry so as to respond to the new needs of consumers.



**Frypan**  
Padella

art.	Ø cm.
11014F20	20
11014F24	24
11014F28	28
11014F32	32



**Cover**  
Coperchio

art.	Ø cm.
11161F16	16
11161F20	20
11161F24	24
11161F28	28



**Baking sheet alusteel**  
Teglia forno, acciaio alluminato

art.	Ø cm.
11739F20	20
11739F24	24
11739F28	28
11739F32	32



**Strainer with hook**  
Colapasta con manico e gancio

art.	Ø cm.
11924F20	20



**Conical colander**  
Colapasta tronco conico

art.	Ø cm.
11930F24	24





**One piece ladle**  
Mestolo unipezzo

art.	Ø cm.
11970F06	6,5
11970F08	8,0
11970F10	10



**One piece skimmer**  
Schiumarola unipezzo

art.	Ø cm.
11971F10	10
11971F12	12



**One piece perforated spatula**  
Paletta forata unipezzo

art.	Ø cm.
11973F10	10
11973F12	12



**One piece basting spoon**  
Cucchiaione unipezzo

art.	
11982F38	



**Stock pot**  
Pentola alta

art.	Ø cm.
12001F20	20
12001F24	24
12001F28	28



**Saucepot 2 handles**  
Casseruola alta 2 maniglie

art.	Ø cm.
12007F16	16
12007F24	24
12007F28	28



**Colander for low stock pot**  
Colapasta per pentola bassa

art.	Ø cm.
12123F20	20
12123F24	24
12123F28	28



**Wire whip, 8 wires**  
Frusta 8 fili

art.	l. cm.
12928F30	30
12928F35	35



**Egg whisk, 11 wires**  
Frusta 11 fili



art.	l. cm.
12929F30	30
12929F35	35



**Gastronorm Container**  
Bacinella gastronorm



art.	GN	dim. cm.
14102F02	1/1	53x32,5x2
14102F04	1/1	53x32,5x4
14102F06	1/1	53x32,5x6,5
14102F10	1/1	53x32,5x10
14102F15	1/1	53x32,5x15
14102F20	1/1	53x32,5x20
14103F02	2/3	35,3x32x2
14103F04	2/3	35,3x32x4
14103F06	2/3	35,3x32x6,5
14103F10	2/3	35,3x32x10
14103F15	2/3	35,3x32x15
14103F20	2/3	35,3x32x20
14104F06	2/4	53x16,2x6,5
14104F10	2/4	53x16,2x10
14104F15	2/4	53x16,2x15
14105F02	1/2	32x26,5x2
14105F04	1/2	32x26,5x4
14105F06	1/2	32x26,5x6,5
14105F10	1/2	32x26,5x10
14105F15	1/2	32x26,5x15
14105F20	1/2	32x26,5x20
14107F06	1/3	32,5x18x6,5
14107F10	1/3	32,5x18x10
14107F15	1/3	32,5x18x15
14107F20	1/3	32,5x18x20
14108F06	1/4	26,5x16x6,5
14108F10	1/4	26,5x16x10
14108F15	1/4	26,5x16x15
14108F20	1/4	26,5x16x20
14109F06	1/6	17,6x16x6,5
14109F10	1/6	17,6x16x10
14109F15	1/6	17,6x16x15
14109F20	1/6	17,6x16x20
14110F06	1/9	17,6x11x6,5
14110F10	1/9	17,6x11x10



**Gastronorm cover**  
Coperchio gastronorm



art.	GN
14502F00	1/1
14503F00	2/3
14504F00	2/4
14505F00	1/2
14507F00	1/3
14508F00	1/4
14509F00	1/6
14510F00	1/9



**Bread knife**  
Coltello pane



art.	l. cm.
18028F21	21
18028F25	25
18028F30	30
18028F36	36



**Pizza wheel**  
Rotella tagliapizza



art. 18324F10      Ø cm. 10



**Spatula perforated**  
Spatola pasticcio e pizza forata



art. 18510F07



**Pizza turner**  
Spatola per pasticcio e pizza



art. 18511F15



**Pastry spatula**  
Spatola per dolci



art. 18513F14



**Baking sheet alusteel**  
Teglia rettangolare, alluminata



art.	dim. cm.
41751F30	30x23x3
41751F40	40x30x3
41751F60	60x40x3



**Cutting board**  
Tagliere



art.	GN	dim. cm.	col.
42522F09	1/2	32x26,5x2	●



**Cutting board**  
Tagliere



art.	GN	dim. cm.	col.
42538F09	1/1	53x32,5x2	●



**Cutting board**  
Tagliere



art.	dim. cm.	col.
42539F09	60x40x2	●



**Bread tongs**  
Molla pane



art. 52550F63      l. cm. 23



**Spaghetti tongs**  
Molla spaghetti



art. l. cm.  
52550F73 21



**Toast-pastry tongs**  
Molla toast-dolci



art. l. cm.  
52550F78 24



**Cake pliers**  
Pinza torta



art. l. cm.  
52550F80 28



**Pastry pliers**  
Pinza dolci



art. l. cm.  
52550F88 18

**SPARE PARTS**  
RICAMBI



**Tap/Rubinetto : For/Per # 11102**

art.  
11102-99



**Roasting pan grid/Griglia brasiera : For/Per # 11965**

art. dim. cm.  
11966-50 50x30  
11966-60 60x35  
11966-61 61x43



**Clutch left, Asia rectangular/Frizione sx Asia rettangolare**

art.  
18132-KP



**Clutch right, Asia rectangular/Frizione dx Asia rettangolare**

art.  
18132-KQ



**Clutch right Asia /Frizione dx Asia**

art. Ø cm.  
18136-KQ 33-40



**Clutch left, Asia/Frizione sx Asia**

art.	Ø cm.
18136-KP	33
18136-KR	40



**Clutch spring for rect. ABS, long side opening/Frizione molla ABS rett., apertura lato lungo**

art.
18162-AF



**Clutch spring for rect. ABS, short side opening/Frizione molla ABS rett., apertura lato corto**

art.
18162-AG



**Spare parts/Ricambi : For/Per # 58166A**

art.	des	Ø cm.
18166-AD	Clutch/Frizione	24
18166-AE	Clutch/Frizione	36
18166-AF	Clutch/Frizione	40
18166-AH	Clutch/Frizione	30



**Spare parts/Ricambi : For/Per # 58172A54**

art.	des
18172-AF	Clutch spring/Frizione molla



**Spare parts/Ricambi : For/Per # 58172A56**

art.	des
18172-AG	Clutch spring/Frizione molla



**Spare parts/Ricambi : For/Per # 58176A**

art.	des
18176-AE	Clutch for ABS Ø cm 36/Frizione ABS Ø cm 36
18176-AF	Clutch for ABS Ø cm 40/Frizione ABS Ø cm 40
18176-AH	Clutch for ABS Ø cm 30/Frizione ABS Ø cm 30



**Cutlery bag  
Borsa porta coltelli**

art.
18190-AA





**Spare parts/Ricambi : For/Per # 18353-17**

art.	des
18353-AA	Juice container/Contenitore succhi
18353-BB	Tap/Rubinetto
18353-CA	Lid/Coperchio
18353-DB	Drip bowl/Ciotola raccogli gocce
18353-VA	Eutectic pad/Contenitore eutettico



**Spare parts/Ricambi : For/Per # 19810-00**

art.	des
19810-AA	Blade/Lama
19810-AB	Gear/Ruota dentata



**Spare porcelain/Ricambio porcellana : For/Per # 41311-00**

art.
41311-AA



**Spare stand/Ricambio supporto : For/Per # 41311-00**

art.
41311-AB



**Non slip feet/Piedini antiscivolo : For/Per # 41323**

art.	Pcs/Pz
41323-AA	6



**Folding lid/Coperchio a ribalta**

art.	Ø cm.
41400-AB	23,5
41405-AB	13,5



**Cereal-bar glass/Barattolo cereali, vetro : For/Per # 42460-43; 42470-43**

art.	lt.
41402-AA	2



**Eutectic pad/Eutettico : For/Per # 41488**

art.	Ø cm.	h. cm.
41443-AE	10,5	2



**Tray/Vassoio : For/Per # 41447-05**

art.  
41447-39



**Stoppers/Tappi pompa : For/Per # 41500-00**

art. Pcs/Pz  
41500-AA 2



**China cup/Porcellana : For/Per # 41563-07**

art.  
41563-AA



**China cup/Porcellana : For/Per # 41564-07,**

art.  
41564-AA



**Cheese jar/Vetro formaggiere : For/Per # 41638-01**

art.  
41638-91



**Spare parts/Ricambi : For/Per # 41638-02-04-12-13**

art.	des
41638-92	Oil/Winegar bottle/Ampolla olio/acetato
41638-93	Salt shaker/Vetro spargi sale
41638-94	Pepper shaker/Vetro spargi pepe
41638-95	Toothpick glass/Vetro porta stecchi



**Brush/Spazzola : For/Per # 41767-20**

art.  
41767-AA



**Euthetic pad/Eutettico tondo**

art.	Ø cm.	h. cm.
41910-AL	15	2,5

**Spare parts/Ricambi : For/Per # 41911**



art.	des
41911-AA	Canister/Contentitore
41911-AE	Slide SAN/Scivolo SAN

**Cover/Tappo : For/Per # 42401**



art.
42401-AA

**Cover/Tappo : For/Per # 42505**



art.
42405-AA

**Set 10 blades/Set 10 lame : For/Per # 42520-00**



art.
42520-AA

**Spare parts/Ricambi : For/Per # 42570-32**



art.	des	mm.
42570-91	Disc/Griglia	1,5
42570-92	Disc/Griglia	2,5
42570-94	Disc/Griglia	4,0
42570-99	Cranck/Manovella	

**Spare parts/Ricambi : For/Per # 42573-31**



art.	des	mm.
42573-91	Disc/Griglia	1,5
42573-92	Disc/Griglia	2,5
42573-94	Disc/Griglia	4,0
42573-99	Cranck/Manovella	

**Spare parts/Ricambi : For/Per # 42574-37**



art.	des	mm.
42574-90	Disc/Griglia	1,0
42574-91	Disc/Griglia	1,5
42574-92	Disc/Griglia	2,0
42574-93	Disc/Griglia	3,0
42574-94	Disc/Griglia	4,0
42574-99	Cranck/Manovella	

**Spare parts/Ricambi : For/Per # 42575-37**



art.	des	mm.
42575-90	Disc/Griglia	1,0
42575-91	Disc/Griglia	1,5
42575-92	Disc/Griglia	2,0
42575-93	Disc/Griglia	3,0
42575-94	Disc/Griglia	4,0
42575-99	Cranck/Manovella	



**Spare parts/Ricambi : For/Per # 42577-39**

art.	des	mm.
42577-90	Disc/Griglia	1,0
42577-91	Disc/Griglia	1,5
42577-92	Disc/Griglia	2,0
42577-93	Disc/Griglia	3,0
42577-94	Disc/Griglia	4,0
42577-99	Cranck/Manovella	



**Spare parts/Ricambi : For/Per # 42929-03**

art.	des
42929-AA	Salt shaker/Vetro spargisale
42929-AB	Pepper shaker/Vetro spargipepe
42929-AC	Oil/Winegar bottle/Ampolla olio/aceto



**Glass/Vetro : For/Per # 42939-15**

art.
42939-AA



**Glass/Vetro lampada : For/Per # 42941-22**

art.
42941-AA



**Wheel/Ruota : For/Per # 44023-00 # 44024-00**

art.
44023-AA



**Dish separation grid /Griglia divisoria : For/Per # 44027-00**

art.
44027-AA



**Eutectic pad/Piastra eutettica : For/Per # 44094R00**

art.	des	dim. cm.
44094-RE	Temp. -32°C	13X23X3,5

**Sponge/Spugna : For/Per # 44101-03**



art.  
44101-AA

**Container/Contenitore : For/Per # 44103**



art.	des
44103-AA	3 comp.
44103-AB	4 comp.
44103-AC	6 comp.

**Flat mop/Frangia mop : For/Per # 44160-03**



art.  
44160-AA

**Trolley bags/Sacchi carrello : For/Per # 44174-24**



art.  
44174-AA

**Burner/Portacombustibile : For/Per # 44225-22; 44227-30**



art.  
44220-AA

**Cream puff nozzle/Beccuccio riempi bigne' : For/Per # 47612-01**



art.  
47612-AA

**Bone-saw blade/Lama per sega : For/Per # 48231**



art.	mm.
48232-40	400
48232-45	450
48232-50	500

**Spare parts/Ricambi : For/Per # 49811-00**



art.	des
49811-01	Cutting knife kit/Kit lama
49811-02	Blade/Lama

**Spare parts/Ricambi : For/Per # 49812-00**



art.	des
49812-01	Blade and wheel/Lama e ruota dentata
49811-02	Blade/Lama

**Spare parts/Ricambi : For/Per # 49814-00**



art.	des
49811-02	Blade/Lama
49814-01	Blade and wheel/Lama e ruota dentata



**Set 7 blades/Set 7 lame : For/Per # 49829-11**

art.  
49829-BA



**Spare parts/Ricambi : For/Per # 49830-60**

art.	des
49830-00	Slicer/Mandolino
49830-02	Protective carriage/Carrello
49830-AA	38 Blades/Pettine 38 lame
49830-AB	44 Blades/Pettine 44 lame
49830-AC	60 Blades/Pettine 60 lame



**Spare parts/Ricambi : For/Per # 49832-10**

art.	des	mm.
49832-80	Pusher/Pressatore	10
49832-86	Pusher/Pressatore	6
49832-88	Pusher/Pressatore	8
49832-90	Blade/Lama	10
49832-96	Blade/Lama	6
49832-98	Blade/Lama	8
49832-99	Carriage/Guida di scorrimento	



**Spare parts/Ricambi : For/Per # 49834-00**

art.	des
49834-01	Peeling blade/Lama a pelare
49834-02	Slicing blade/Lama affettare



**Spare parts/Ricambi : For/Per # 49835-00**

art.	des
49835-01	Peeling blade/Lama a pelare
49835-02	Slicing blade/Lama affettare



**Blade assembly/Set lame : For/Per # 49837-05**

art.  
49837-AA



**Blade assembly/Set lame : For/Per # 49838-08**

art.  
49838-AB



**Corkscrew worm/Verme cavatappi : For/Per # 49858-00**

art.  
49858-AA

**Grinding wheel assembly/Set ruota molatrice : For/Per # 49872-00**

art.  
49870-AA

**Disc/Griglia : For/Per # 49879-37**

art.	mm.
49879-90	1,0
49879-91	1,5
49879-92	2,0
49879-93	3,0
49879-94	4,0

**Pedal & opening assembly/Pedaliere e movimento : For/Per # 49899-01**

art.  
49899-AA

**Glass/Bicchiere : For/Per # 49956-01**

art.  
49956-AA

**Display for fry pans/Espositore per padelle ferro**

art.  
XO1046

# **ALPHABETICAL INDEX**

## **INDICE ALFABETICO**



**A**

Absinthe spoon	310
Acetate sheets	206
Adaptor bar	60
Agemono pot and stand	266
Air pot	432
Airbrush	196
Airbrush compressor	196, 517
Airtight cover for bowls	424
Almont past knife	181
Angular spatula	79, 96
Apple corer/wedger	88, 91, 115
Apple peeler	115
Apron, LDPE	169, 489
Artichoke corer	116
Ash shovel	272
Ashtray	372
Asparagus peeler	87
Asparagus tong	390
Atomizer dash bottle	321
Automatic dispenser	488
Avocado peeler/slicer	117

**B**

Bag clip	112, 192
Baguette bread basket	416
Bain-marie pot	26, 31, 38
Baking beans	205
Baking mat, silicone	204
Baking paper	204
Baking sheet trolley	476-477
Baking tray, aluminum	194, 282
Baking tray, alusteel	194, 280-282
Baking tray, non stick coated	195, 282
Baking tray, perforated, aluminum	194, 282
Baking tray, perforated, non stick	282
Baking tray, perforated, silicone	195, 205
Baking tray, silicone coated	195, 205
Balti pan	266
Bar items	302-331
Bar liner	324
Bar organizer	320
Bar runner	324
Barbecue brush	103
Barman apron	325
Barman's set	325
Base for ganache & frames	199
Basket with wire stand	419
Baster tube	102
Basting spoon	100
Basting spoon, one piece	98
Beer glass	313
Bento box	259
Bento tray	259
Bike basket rack	277
Bird nest fryer	100
Biscuit spatula	198
Blender	510-511
Block brush	165
Board scraper	167
Bone-saw	163
Bordelais moulds	38
Boston shaker	313

Bottle cooler	367-368
Bottle opener	86, 90, 330
Bottle pourer	327-328
Bottle rack wall mounting	326
Bottles/cans press	125
Bouillon cloth	112
Bourguignonne fondue set	363
Bowl double wall	434-435
Bowl holder	424-426
Bowl, BPA Free	296-298
Bowl, glass	424
Bowl, MF257-258, 350-351, 394-396, 399-402, 424, 426	
Bowl, wood	337-338
Box with lid	286, 294
Bread basket	358, 414-420, 467
Bread basket cover	418
Bread basket stand	419
Bread box	414
Bread brush	255
Bread canvas bag	358-359, 420
Bread cutting board	414
Bread mould	195, 254
Bread proofing basket	255
Bread roll-dispenser	415
Bread slicer	415
Bread tong	80, 390
Breadstick basket	361
Breakfast tray with legs	455
Broom	483
Broom & dust pan	482
Brush for grill cleaning	273
Brussel sprout cutter	116
Bucket graduated	109, 485
Buffet box	413-414
Buffet display	405-406
Buffet display items	393-449
Buffet ladder	427-429
Buffet stand	425-426, 429-430
Butchers table	166
Butter churn	122
Butter cup	356
Butter curler	87, 92
Butter mould	122
Butter spreader	85, 90, 391

**C**

Cake cooling tray	194
Cake frames	207-209
Cake marker	201
Cake mould, non-stick	212-217
Cake peel	193
Cake plate, swivel base	193
Cake platter	289
Cake ring, microperforated	209
Cake server	390
Cake setting ring	207
Cake slicer	198
Cake stand	288-289
Cake tray	288
Can opener	86, 90-91, 124
Can opener electric	520
Candelabra	370
Candleholder	370-371
Candles led	411, 371

Candlestick	369-370
Canister	26
Canning jar set	333
Cap, TNT	169, 490
Cappuccino milk pot	286
Caps dispenser box	491
Caramelising rod	196
Caramelizer	518
Card holder	371
Cash tray	287
Caviar cooler	366
Caviar flatware	366
Ceddar/cheese grater	86
Cereal bar	430
Cereal dispenser	430-431
Cereal pitcher	430
Chafing dish stand	447
Chafing dishes	436-443
Chainmail apron	167
Chainmail glove	167
Chalkmarker	292, 420
Champagne glass	303, 314
Champagne saber	369
Champagne stopper	328
Champagne tong	369
Champagne waterfall	408
Changing table	480
Charlotte comb	217
Cheese cleaver	85, 89
Cheese fondue set	363
Cheese jar	361
Cheese knife	84, 85, 89
Cheese rotary grater	118
Cheese shaker	361
Cheese slicer	85, 89
Chef's hat, TNT	169
Chef's suitcase	158
Chef's torch	197
Cherry core stripper	119
Chestnut knife	84
Chinese colander	111
Chinese hot pot	267
Chinese kitchen scissors	268
Chinese spoon	261
Chocolate fountain	407, 515
Chocolate mould, PC	222-229
Chocolate mould, silicone	221
Chopstick rest	262
Chopsticks	262, 269
Christmas moulds	231
Cigar ashtray	373
Cigar humidor	373
Cigar scissors	373
Cinnamon shaker/mill	386
Citrus fruit squeezer	509-511
Citrus knife	87
Clay pot	267
Cleaning & safety items	479-496
Cleaning system, Pulse	482
Cleaning wand	483
Cleansing foam	488
Clips for lids	71
Cocktail fountain	407
Cocktail glass	316
Cocktail measuring cup	311

Cocktail picks	331			Ethnic cuisine items	256-269
Cocktail spoon	92, 309	<b>D</b>		Euronorm tray	475
Cocktail strainer	310	Dash bottle	321-322	Eutectic pad	423, 470
Cocoa dredger	285	Decorating combs	203	Expanding pastry cutter	200
Cocoa stencils	284	Decorating knife	88, 92	Extensible frame	207
Coffee measuring spoon	91	Decorating spoons	106, 181	External piping tip adapter	190
Coffee percolator	445, 514	Decorating tips, ISI	300		
Coffee set	287, 338	Decoration tools	121	<b>F</b>	
Coffee urn	443	Decorative scrapers	292	Face masks	489
Cognac warmer	369	Deep plate	260	Face shield	489
Cola cup	305	Dehydrator	503	Farinata knife	96
Colander	108-109	Dim Sum steam rack	265	Fast food tray	474
Collapsible frame	480	Dipping forks	181, 364	Finger-food, PR	343-344
Condiment holder	324	Dish	258	Fish bone remover	102
Condiment set	360-361	Dish dolly	463	Fish kettle	25, 31, 38
Cone holder	294-295	Dish warmer	502	Fish scaler	84-85, 89, 269
Confectionery funnel	195	Dispenser	105-106	Fish spatula, one piece	99
Conical colander	108	Display for ice cream cones	299	Fish/chips spatula	80
Conical strainer	82, 89	Display tray	163, 204	Flair bottle	320
Contact grill	499	Disposable baker's blades	255	Flat plate	260, 351
Cookie cutter frame	219	Disposable trolley covers	475	Flavour marker	293
Cookie press	192	Doilies	193	Flax seeds mill	386
Cooking tongs	102-103	Dolly	466	Floor sign 2-sided	484
Cookware, pots & pans 3-Ply	21-23, 434	Dolly for cases	478	Floor standing ashtray	488
Cookware, pots & pans aluminum	27-31, 39	Dolly for insulated ctns	470	Flour scoop	107
Cookware, pots & pans cast iron	41-48	Dome cover	288-289, 362	Flour sifter	203
Cookware, pots & pans copper	34-38	Double sided tray	259	Flower vase	369
Cookware, pots & pans s/steel	44-105	Dough box	279	Foil cutter	329
Cool bowl	425	Dough plunger cutters	180-181	Folding ladder	487
Cool showcase	423	Dough scrapers	278-279, 202-203	Fondue set	38
Cooler, PC	315	Drain tray	466	Food container	465-466
Cotton mop	483-484	Drainer	237	Food pans for chafing dishes	447-448
Counter ice cream cone holder	293	Drainer plate	60, 62, 64, 66, 69	Foodloops	113
Couscous pan	28	Draining rack	194, 463	Foot pedal gel dispenser	490
Cover for bowls	424, 426	Dressing spoon	392	Forehead infrared thermometer	489
Cream chargers, ISI	301	Drink mixer	510-511	Fork	93
Cream chargers, Kayser	300	Duck fur pincer	268	Forks, disposable	331
Cream dispenser	195	Dumplin maker	124	Four-ways grater	123
Cream horn moulds	191	Dunnage rack	487	Frames pastry, plastic	218-219
Cream injector	195	Dust beater V sweeper	482	Frames pastry, stainless steel	218
Cream roll moulds	191	Dust cover	463	French fry cutter	117
Cream whipper thermo, ISI	300	Dustpan	483	French fry scoop	101
Cream whipper, ISI	300			French press	354
Cream whipper, Kayser	300	<b>E</b>		Fruit basket	317, 357
Crème brûlée bowl	50	Easter moulds	231	Fruit cutter	114
Crème caramel mould	209	Egg basket	420	Fruit decorating knife	88
Crepe machine	500-501	Egg boiler	501	Fruit scoop	87
Crepe spreaders	101	Egg container	116	Fruit stand	407, 427
Crockery transport box	464	Egg cup	356	Fruit tong	389
Croissant cutter	201	Egg dish	50	Fry basket	60, 269
Cube cutter	114	Egg knocker	116	Fry dripping tray	25
Cup	296-298	Egg mould	230	Fry pan, non stick	12, 22, 29, 30, 40, 266
Cut resistant glove	168	Egg rings	116	Fry pan, steel	33, 265-267
Cutlery dispenser	361-362, 424	Egg separator	92	Fry wire basket	33, 266
Cutlery holder	461-462	Egg slicer	116	Fryer	501-502
Cutter turn'up	119	Egg wedger	115	Frying oil test strips	133
Cutter/corer	119	Electric appliances	497-520	Fuel Holder	448
Cutter/vegetable slicer	507-508	Electric heating units	449	Funnel	104-105
Cutting board	165-167	Electric peeler	115, 503	Funnel, ISI	301
Cutting board rack	167	Electric sieve	124		
Cutting roller	200	Emulsifier-mixer	508	<b>G</b>	
		Escargot dish	366	Ganache frames	199
		Escargot fork	392	Garlic press	90, 118
		Escargot picks	366	Gastronorm basket	467

Gastronorm tray	475	Ice cream server	291	Lanterns	410
Gel dispenser	490	Ice crusher	510-511	Larding needled	161
Glass cleaning brush	326	Ice crusher	318	Lasagne spatula	93, 96
Glass clip holder	330	Ice knife	121	Lemon squeezer	317
Glass rack	326	Ice pick	318	Lemon striper	88, 92
Glass rimmer	324	Ice scoop	318	Lever corkscrew	329
Glasses	296-298	Ice spoon	318, 392	Lid for ice cream container	291
Glasses, Weck	352-353	Ice tea spoon	310, 392	Lightning column	407
Gloves	169	Ice tong	320, 390	Liquidiser	506-507
Gloves dispenser box	490-491	Ice tube mould	298	Lobster cracker	365
Gloves disposable	489	Ice-box	422	Lobster fork	366
GN food pans aluminum	59	Ice-cream items	290-301	Lobster pick	365
GN food pans enamelled	60	Ice-dipper	291	Log mold	217
GN food pans melamine	72-73	Icing bag holder	193	<b>M</b>	
GN food pans non stick coated	55	Icing bags	191-192	Magic spoon whisks	310
GN food pans polycarbonate	61-62	Icing bags/nozzles wall rack	193	Magnetic chocolate mould	228
GN food pans polypropylene	65-71	Induction adapter	110	Maki roll mould	263
GN food pans porcelain	74-77	Induction cooker	438, 514	Mandoline	119
GN food pans stainless steel	52-60	Infrared lamp	505	Manual sharpener	160
GN food pans Tritan	63-64	Injector needles, ISI	301	Margarita cup	303
Gourmet bowl	296	Insulated beverage dispenser	472	Margarita glass	314, 317
Gourmet tray	296	Insulated beverage server	354	Marinating syringe	102
Grape scissor	389	Insulated containers	276, 469-472	Markers	71
Grapefruit knife	87, 91	Insulated dispenser	432	Martini cup	303
Grater	90, 118, 122-123	Insulated sauce boat	356	Martini glass	314, 316
Gravy boat	357	<b>J</b>		Marzipan tools	181
Grid enamelled	60	Jam bar	430	Masks dispenser box	491
Grill stone table barbecue	364	Japanese chopsticks	262	Measuring jug	105
Guitar	199	Japanese jigger	311	Measuring pourer	327-328
<b>H</b>		Japanese omelettes pan	266	Measuring spoons/cups	105
Ham stand	163-164	Jelly fuel	449	Meat ball plier	81
Ham tong	162	Juice dispenser	431-432	Meat cleaver	150-151
Hamburger press	164	Juice extractor	507-509	Meat fork	94, 100, 153, 391
Hamburger turner	96	Juice glass	313	Meat fork, one piece	98-99
Hand hygiene station	488	Juice pitcher	354-355	Meat hook	161
Hand roll stand	260	Julep mug	306	Meat mincer	518
Hangiri/sushi rice tub	264	Julep strainer	310	Meat pan	163
Hat pin for tickets	103	<b>K</b>		Meat tenderizer	162
Heat accumulator	470	Kaiser bread marker	255	Mechanical sweeper	482
Heated showcase	502	Kebab/Gyros grill	500	Melon baller	86, 91
Herb mill	124	Kettle for mixing machines	110	Melon peeler	87
Herb scissors	117	Kitchen bowl	108	Menu stand	371
Herb/chili mill	384-385	Kitchen scissors	154-155	Mesh skimmer	100
Holder for blast chiller	298	Kitchen tools wall rack	100	Microfibre cloths	484
Honey/cream dispenser	285	Kitchen utensils	78-136	Microfibre mops	482
Hors-d'oeuvres plier	389	Knife block	159-160	Microwave oven	512
Hot dog heater	500	Knife rack	160	Milk dispenser	431-432
Housekeeping cart	481-482	Knife roll-bag	159	Milk frothing thermometers	285
Hydrometer for brine/salt	132	Knife sanitizing system	160	Milk pot with lid	286
Hygienic cover	414-415	Knife sharpener electric	520	Mincing knife	152-153
<b>I</b>		Knife sterilizer	520	Mini push up pops	299
Ice bucket	320, 472	Knives forged	137-139	Minibar restocking cart	477
Ice cart	472	Knives Japanese	156-157	Mini-guitar	113
Ice chisel	121	Knives stamped	140-153	Mint julep cup	305
Ice cream basin	291	<b>L</b>		Mirror	409-410
Ice cream cake ring	206	Labels solvable	133-134	Mixer/liquidiser combi unit	506
Ice cream container	291	Ladle	80-81, 92, 94, 100, 269, 391	Mixing bowl	38, 108, 110
Ice cream counter display	298-299	Ladle perforated, one piece	98	Mixing glass	313
Ice cream cup	295	Ladle perforated, tube handle	98	Mixing spoon	101
Ice cream maker	503	Ladle, one piece	98-99	Mobile pedal bin	486-487
Ice cream mould	299	Ladle, tube handle	98	Mobile plate rack	473
Ice cream scoop	91, 292			Moisture bottle	203
				Monoportion fork /spoon	392

Monoportion tray	220	Pastry brush	85, 90, 202	Pumpkin mug	303
Mooncake mould	263	Pastry cutters, PA+	180	Punch bowl	408
Mop handles	apr-01	Pastry cutters, stainless steel	171-179	PVC ribbon	206
Mop holder	483	Pastry moulds, silicone	232-253	<b>QR</b>	
Mopping trolley w/press	484-485	Pastry plier	389	Quenelle plier	81
Mortar and pestle	268	Pastry spatula	96	Raclette maker	363, 516
Moscow mule mug	303-305	Pastry stand	287	Rake	272
Mould for ice-balls	318-319	Pastry tong	80	Ramekin	50
Mould for ice-cubes	319	Pastry tube brush	190	Rapid infusion kit, ISI	301
Mould for ice-diamonds	319	Pastry utensils	170-255	Reception bell	372
Mould for ice-skulls	319	Pastry wheel	84, 88, 200	Refrigerated box	457, 474
Mousse ring	206	Peel with handle	274	Refuse bag holder trolley	486
Mozzarella/tomato cutter	113	Peeler on stand	114	Resin spatula	103
Muddler	318	Peeling heads	114	Retractable belt stanchion	495
Multi rack	428-429	Pepper/salt mill	377-387	Revolving bottle rack	326
Multifunction oven	501	Perforated ladle	81	Revolving platter, AR	349
Multipurpose box	463	Perforated slice	99	Rice bowl, MF	257, 259
Multipurpose tong	389	Perforated spatula	81, 93-95	Rice ladle	391
Mushroom cutter	117	Perforated spoon	80, 93-94, 100	Rice scoop	112
Mussel pot	365	Petite marmite	440	Rice spoon	93-94, 263
Mustard cup	356	Peugeot mills	374-387	Rice steamer	511
<b>N</b>		Pie knife	85, 96	Rice steamer shelf	265
Napkin holder	287, 293, 362	Pie plier	389	Roast beef knife	391
Newspaper stick	372	Pie server	93	Roasting pan	25, 30-31, 38, 44
Nigiri mould	263	Piepens, aluminum	210	Roasting pan with lid	434
Nitro Whip, ISI	284	Pineapple cup	303	Roll holder	104, 475
Noshikushi skewers	262, 330	Pineapple peeler/corer	86, 114-115	Rolling dough cutter	202
Nozzles, PC	188-190	Pinneapple slicer	115	Rolling pin	201
Nozzles, PP	188	Pizza cutter	274	Roll-top cover	288, 421-423
Nozzles, s/steel one piece	182-189	Pizza delivery bag	277-278	Room service table	457-458
Nut cracker	365	Pizza items	270-282	Room service tray	455
Nutmeg grater	123	Pizza knife	84, 274	Room-service trolleys	455-458
Nutmeg mill	385-386	Pizza ladle, flat bottom	81, 279	Rubber comb wood effect	217
<b>O</b>		Pizza oven brush	272-273	Ruler	198
Octopus-press	113	Pizza pan rack	280	Runner	347
Oil pourer	268, 271	Pizza pan, blue steel	280-281	<b>S</b>	
Oil/vinegar sprayer	360	Pizza pan, non stick	280	Safety chain for floor signs	484
Oil/winegar stand	361	Pizza pan, perforated, non stick	280	Sake cup	261
Olive seed remover	118	Pizza peel	271-273	Sake jug	261
Orange juicer	317	Pizza peel rack	273	Sake warmer	261
Orange peeler	87, 91, 115	Pizza plate w/wooden platter	275	Salad bowl	357, 398
Oval dish	397	Pizza scissors	274	Salad fork	92
Oven mitts	167-168	Pizza screen	280	Salad spinner	111
Overshoes	169, 490	Pizza screen rack	280	Salad spoon	93
Oyster fork	392	Pizza turner	96	Salad tong	80
Oyster knife	84, 90	Pizza wheel	84, 88, 274	Salamander	500
Oyster plate	366-367, 407	Planetary mixer	512	Salami pricker	160
Oyster/fruit stand	366	Plate	398, 401	Salt spoon	391
<b>P</b>		Plate cover	104	Salt tester	133
Pallet	487	Plate spacer ring	104	Salt/pepper mills	374-387
Pan gripper	274	Plate warmer	364-365	Salt/pepper shaker	360-361
Panettone knife	390	Platform cart	478	Samovar	444-445
Paper cap	169, 489	Platter	400	Sanitizing detergent, floor	484
Paper Chef hat	169	Platter with porcelain surface	339	Sanitizing gel, hands	489
Paring knife	89	Pocket crumber	363	Sauce ladle	92, 391
Parmesan knife	85	Portioning ring	112	Sauce pot wooden platter	340
Parmesan spoon	391	Potato fork	91	Sauce pourer	260
Parsley knife	84	Potato masher	89-90	Sauce spoon	100
Party plate	395	Potato peeler	87, 91, 117	Sausage filler	164
Party spoon	397	Potato ricer	117	Sausage tongs	102
Party tub	408	Potato twist cutter	115	Scales	135-136
		Poultry shears	154	Scoop	267
		Presse canard	113		
		Pretzel stand	414		
		Product list Gluten Free #	521-525		

Scrubbing gloves	168	Spatula	79-81, 90, 93, 96, 101, 269	Sweet box	288
Sea urchin cutter	365	Spatula perforated, one piece	99	Swing table top waste bin	365
Seafood display rack	366	Spatula, one piece	99	Swivel cake stand	288
Segment colander	26	Spatzle sieve	123	Swivel peeler	91
Self-standing guard	493	Speed rack	103, 326	Swords	161
Serving basket sticky rice	264	Spiked roller	200	Syrup density meter	132, 198
Serving board, MF	400	Spiral vegetable slicer	120-121	Syrup density meter test tube	198
Serving board, wood	337-339	Spits, disposable	331	<b>T</b>	
Serving fork	390	Spoon	79-81	Table bag holder	367
Serving platter, MF	336-337	Spoon and cup holder	294	Table barbecue	46, 364
Serving platter, PL	335	Spoon case	294	Table caddy	362
Serving plier	389	Spoon crosswise, one piece	98	Table cigar cutter	373
Serving spoon	390-391	Spoon holder	286	Table crumbler	363
Serving stand	353, 394	Spoon perforated, one piece	98	Table mat	347
Serving stand 2-tier	339, 349, 429	Spoon, one piece	99	Table number stand	371
Serving stand 3-tier	339, 429	Spoons, disposable	331	Table sign	371
Serving tong	80, 102-103, 389	Spray gun	196, 517	Table top can opener	126
Serving trolley	476-477	Spraying bottle	203	Table top service items	345-387
Shaker	311	Spring closure hook	496	Table with hot box	474
Sharpening steel	153	Squeeze bottle	106	Table-cloth clips	362
Sharpening stone	153	Stackable containers	467-468	Table-top cutter	503, 508
Showcase	287, 421-422	Stanchion	496	Tamagoyaki pan	266
Side basting spoon	99	Stanchion sign holder	495	Tapas display	503
Side basting spoon, one piece	98	Stand	403	Tart ring	206
Sieve	107, 203	Stand/basket	405	Tasting bowl	341-342
Sieve electric	520	Steam rack	265	Tasting dish	341-342
Sieve on tripod	124	Steamer	264, 267, 512	Tasting glass	341-342
Sign holders	420	Stencil for grating pastry	201	Tasting/dessert set	333-334
Silicone sleeve	33, 44	Stencils	221	Tawa pan	267
Silicone spoon	94	Step on bin	485	Tea light led	371
Silicone turner	94	Stew pan with lid	434	Tea strainer	356
Sink trolley	466	Sticky rice cooking set	264	Tea-box	286
Sizzler platter	267	Sticky rice lao basket	264	Telescopic door sign	484
Skewers	161	Sticky rice lao pot	264	Telescopic rod	483
Skimmer	80-81, 93-94, 100, 269	Stirrers	308-309	Tempering unit	197, 299-300, 517
Skimmer, one piece	99-100	Stirring ladle	79	Tempura rack	265
Skull dash bottle	321	Stoneware	40	Tepokushi skewers	262, 331
Slicer	164, 518-519	Storage & transport	459-478	Thai knife	121
Slotted turner	100	Storage canister	323	Thermic hot box	457, 474
Small bowl, PR	260-261	Storage container	466	Thermo cover for plate rack	473
Small dish, PR	260	Store & pour container	322-323	Thermohygrometer	132
Smell-remover soap	92	Strainer	82, 111-112	Thermometers	127-133
Smoker	503	Strainer, giant	111	Thermoregulator	449
Smoking gun	321	Straw brush	307	Tickets-holder	103-104
Smoother	198	Straw holder	286	Tiki mug ceramic	307
Snack holder	332-333	Straws	307-308	Tiki skull glass	306
Snail tong	390	Straws case	294	Tilt truck	487
Sneeze guard	492-494	String holder	163	Timer	132
Soba choko cup	259	Sturdy chair	480	Toast rack	356
Soda chargers, ISI	318	Sugar bulb	197	Toast tong	389
Soda siphon, ISI	317	Sugar dredger	203	Toaster	498
Soufflé pot	47	Sugar gloves	168	Toban skillet	266
Soup bowl	357	Sugar lamp	196, 516	Tomato cutter	113
Soup kettle	445-446, 516	Sugar packet holder	286	Tomato juicer sieve	124
Soup plate	351	Sugar pourer	285	Tomato peeler	87
Soup spoon	260	Sugar saucepan	38	Toothpicks	331
Soup strainer	82, 89	Sugar thermometer holder	198	Tortillas cup	47
Sous vide foam tape	131	Sugar tong	390	Tortillas wedger	118
Sous-vide cooking device	513	Sugar/jam thermometer	197	Towel tray	259
Soy pot	261	Sushi geta board	259	Tray stand	411
Space saving box	467	Sushi mat	263	Tray with cover	299
Spaghetti server	93-94, 391	Sushi serving dish	259	Tray with dome cover	349
Spaghetti spoon	100	Sushi tray	396	Tray, AR	348-349
Spaghetti tong	80, 389	Sushi-sashimi boat	260		
Spare parts	525-533	Sushi-sashimi bridge	259		

Tray, MF	257-258, 350-351, 395-396, 399, 402-404	Wire cheese cutter	118
Tray, stainless steel	411-412	Wire dish rack	463
Trivet	44, 365	Wire grid	60
Trolley Quick Cart	480	Wire skimmer	101
Trolley, convertible	478	Wire stand	419-420
Trolleys, dining room	450-458	Wok	22, 33, 43, 264-265
Trolleys, room-service	455-458	Wok brush	269
Truffle jar	359	Wonton noodle skimmer	268
Truffle server	359	Wooden service platter	339-340
Truffle-slicer	359	Worktop	167
Tumbler	314-315		
Tweezer	309		
Twisted rope	496		

## U

Uncorking machine	329
Universal box	293
Universal tray collector trolley	475
Utility rack GN pans	475-477

## V

Vacuum pump wine preserver	330
Vegetable cutter	88, 114
Vegetable preparation machine	507
Vegetable sharpener	85
Vegetable sieve	111, 125
Vegetable slicer	117
Vegetables knife	84, 89
Vegetables serving plier	389
Vinyl bag	481
Visitor kit, TNT	169, 490
Visitor's kit dispenser box	491

## W

Waffle case	294
Waffle iron	504-505
Waiter's corkscrew	329
Wall clock	134
Wall film box	104
Warming plate	505
Wasabi grater	268
Wash racks	460-461
Wash racks dolly	462
Washable kraft paper bag	357
Waste container	485
Water boiler	512
Water jug	316, 354-355
Wedding cake stand	407
Wet sea salt mill	383-384
Whipper heat protector, ISI	301
Whisk	100, 103, 82, 88, 94
Whiskey glass	313-314
Whistling kettle	25
Wine bucket	367
Wine bucket table clip	367
Wine collar	369
Wine cooler stand	367
Wine glass	314
Wine holder	369
Wine pourer	369
Wine stopper	328
Wine taster	369
Winged corkscrew	329
Wire basket, cotton linen	358

## YZ

Y-shaped swivel peeler	87, 91
Zabaione bowl	38
Zaru soba tray	259
Zucchini corer	86, 91

**A**

Acciaino	153	Benna ribaltabile	487	Carrello ritiro vassoi universale	475
Accumulatore di caldo	470	Bicchiere acqua	314-315	Carrello teglie GN	475-477
Accumulatore di freddo	423, 470	Bicchiere cocktail	316	Carrello trasporto materiali	478
Acetato in fogli	206	Bicchiere margarita	314, 317	Carrello vasca	466
Adattatore bocchette	190	Bicchiere martini	314, 316	Carta da forno	204
Adattatore induzione	110	Bicchiere miscelatore	313	Cascata champagne	408
Affetta formaggio	85, 89	Bicchiere succo	313	Casseruola Agemono	266
Affetta mozzarella/pomodori	113	Bicchiere vino	314	Casseruola terracotta	267
Affettatrice	164, 518-519	Bicchiere whiskey	313-314	Casseruola zabaione	38
Affilacoltelli elettrico	520	Bicchierini	296-298, 341-342	Casseruola zucchero	38
Affilacoltelli manuale	160	Bilance	135-136	Catenella sicurezza x cavalletti	484
Affumicatoio	503	Boccale birra	313	Cavalletto di segnalazione	484
Affumicatore	321	Bocchette, inox unipezzo	182-189	Cavatappi cameriere	329
Ago da cucina	161	Bocchette, ISI	300	Cavatappi da parete	329
Alzata 2 piani	339, 349, 429	Bocchette, PC	188-190	Cavatappi doppia leva	329
Alzata 3 piani	339, 429	Bocchette, PP	188	Centrifuga manuale	111
Alzata buffet	403, 425-426, 429-430	Bollitore	25, 512	Centrifuga succhi	507-509
Alzata ceste pane	419	Bollitore uova	501	Ceppa	166
Alzata dolci	287	Bordatore bicchieri	324	Ceppo	167
Alzata frutta	407	Borsa isoterma per pizza	277-278	Ceppo porta coltelli	159-160
Alzata frutti di mare	366	Bottiglia angostura	321-322	Cesta baguettes	358, 416
Alzata torta	288-289, 407	Box buffet	413-414	Cestelli lava bicchieri	460-461
Alzata torta girevole	288	Box isoterma	470-471	Cestello per friggere	33, 60, 266
Alzata/cesto	405	Box portaghiaccio	422	Cestello porta posate	461-462
Anelli per uova	116	Box refrigerato	457, 474	Cestello portapacco bike	277
Anello distanziatore	104	Box termico	474, 457	Cestino agrumi	317
Anello mousse	206	Brasiera	25, 31	Cestino impasto	255
Anello per impiattare	112	Bruschino per bocchette	190	Cesto c/supporto in filo	419
Anello regolabile	207	Buffet e presentazione, articoli	393-449	Cesto frutta	357
Anello torte	206	Bustina carta	169, 489	Cesto gastronom	467
Apparecchi elettrici	497-520	<b>C</b>		Cesto in filo, fodera cotone	358
Apparecchio cottura sottovuoto	513	Caffettiera pressa filtro	354	Cesto pane	358, 414-420, 467
Apribottiglie	86, 90	Campanella reception	372	Cesto pane carta kraft	357
Apriscatole	86, 90-91, 124	Candelabro	370	Cesto pane cotone	420, 358-359
Apriscatole da banco	126	Candele led	371, 411	Cesto per riso dolce	264
Apriscatole elettrico	520	Candeliere	369-370	Cesto uova	420
Apriuova	116	Cannello	197	Chitarra	113, 199
Arricciaburro	87, 92	Cannoli	191	Ciotola doppia parete	434-435
Aspirapolvere meccanico	482	Cannucce	307-308	Ciotola refrigerata	425
Asta appendi mestoli	100	Cappello Chef	169	Ciotola tortillas	47
Asta porta scontrini	103-104	Caraffa	316, 354-355	Ciotola, legno	337-338
Aste delimita corsie	496	Caraffa cereali	430	Ciotola, MF257-258, 350-351, 394-396, 399-402, 424, 426	
		Caraffa graduata	105	Ciotola, vetro	424
		Caraffa sake	261	Ciotolina	296-298
		Caraffa termica	354, 432	Ciotolina degustazione	260-261, 341-342
		Caramellizzatore	196, 518	Ciotolina gourmet	296
		Carapina	291	Clip chiudi sacco	112, 192
		Carrelli room-service	455-458	Clip porta targhetta	420
		Carrelli sala	450-458	Clip reggibicchiere	330
		Carrello convertibile	478	Clips per coperchi	71
		Carrello di servizio	476-477	Cloche	288-289, 362
		Carrello ghiaccio	472	Cocotte per molluschi	365
		Carrello lavapavimenti	484-485	Colafritto	25, 100
		Carrello per ctn isoterma	470	Colapasta	108-109
		Carrello per derrate	466	Colapasta a spicchi	26
		Carrello porta biancheria	481-482	Colapasta conico	108
		Carrello porta cassette	478	Colatutto gigante	111
		Carrello porta cestelli	462	Colino	82, 89, 111-112
		Carrello porta piatti	463, 473	Colino cocktail	310
		Carrello porta sacco	486	Colino conico	82, 89
		Carrello porta teglie	476-477	Colino Julep	310
		Carrello Quick Cart	480	Collare salvagoccia	369
		Carrello rifornimento frigobar	477	Colonna luminosa	407
				Colonna portasecchiello	367
				Coltelleria forgiata	137-139

**B**

Bacchette cinesi	262, 269
Bacchette giapponesi	262
Bacinella carré	195
Bacinella conica	108
Bacinella gelato	291
Bacinella planetaria	110
Bacinella semisferica	108, 110
Bagnomaria	26, 31, 38
Bar, articoli	302-331
Barattoli degustazione	333
Barbecue da tavola	46, 364
Barca sushi/sashimi	260
Barra porta coltelli magnetica	160
Barriera autoportante	493
Barriera protettiva	492-494
Base per ganache & telai	199
Bastardella semisferica	38
Batticarne	162

Coltelleria stampata	140-153	Coppino salsa	391	<b>E</b>	
Coltelli Giapponesi	156-157	Coprimanico silicone	33, 44	Elenco prodotti Gluten Free	521-525
Coltello agrumi	87	Copripiatto	104	Erogatore automatico	488
Coltello apriostriche/cozze	84, 90	Copriscarpe	169, 490	Espositore buffet	427-429
Coltello arrosto	391	Cordone	496	Espositore cereali	430
Coltello castagne	84	Cornetti	191	Espositore marmellate	430
Coltello decoratore	88, 92	Cornetto cinese	111	Espositore mini cornetti	299
Coltello farinata	96	Couscoussiera	28	Espositore per vetrina gelato	298-299
Coltello formaggio	84, 85, 89	Crème caramel	209	Espositore porta frutta	427
Coltello ghiaccio	121	Crepiera	500-501	Espositore sacchetti/bocchette	193
Coltello grana	85	Cucchiaini decoratori	106, 181	Etichette dissolvibili	133-134
Coltello marzapane	181	Cucchiaini monouso	331		
Coltello panettone	390	Cucchiaino sale	391	<b>F</b>	
Coltello pizza	84	Cucchiaino a servire	390-391	Falcetta macellaio	150-151
Coltello pizzaiolo	274	Cucchiaino assenzio	310	Falcetta prezzemolo	84
Coltello pompelmo	87, 91	Cucchiaino bibita	310, 392	Falso fondo forato	60, 62, 64, 66, 69
Coltello torta	85, 96	Cucchiaino brodo	260	Fascia microforata	209
Coltello verdure	84, 89	Cucchiaino cinese	261	Fasciatoio	480
Combi mixer/frusta	506	Cucchiaino cocktail	92	Ferma prosciutto	163-164
Combinato cutter/tagliaverdure	507-508	Cucchiaino finger-food	397	Fermatovaglia	362
Compressore x penna aerografa	196, 517	Cucchiaino ghiaccio	318, 392	Finger-food	343-344
Cono boston	313	Cucchiaino insalata	93	Flacone dosatore	106
Contenitore cilindrico	26	Cucchiaino magico	310	Flacone nebulizzatore	203
Contenitore con coperchio	286, 294	Cucchiaino miscelatore	309	Flacone per bagne	203
Contenitore isoteramico	276	Cucchiaino monoporzione	392	Flair bottle	320
Contenitore per alimenti	465-466	Cucchiaino parmigiano	391	Fonduta bourguignonne	38, 363
Contenitore per cannucce	294	Cucchiaino riso	93-94, 263, 391	Fonduta formaggio	363
Contenitore per cialde	294	Cucchiaino salsa	392	Fontana cioccolato	407, 515
Contenitore per impasti	279	Cucchiaino silicone	94	Fontana cocktails	407
Contenitore per palette	294	Cucchiaino spaghetti	100	Forbice antipasti	389
Contenitore per riso dolce	264	Cucchiainone	79-81, 100-101	Forbice dolci	389
Contenitore per uova	116	Cucchiainone forato	80, 93-94, 100	Forbice erbe	117
Contenitore rifiuti	485	Cucchiainone forato unipezzo	98	Forbice pizza	274
Contenitore riserva	323	Cucchiainone obliquo unipezzo	98	Forbice polpette	81
Contenitore salvaspazio	467	Cucchiainone salse	100	Forbice quenelle	81
Contenitore universale	288, 293	Cucchiainone unipezzo	98-99	Forbice sigari	373
Contenitore versatore	322-323	Cucina etnica, articoli	256-269	Forbice torta	389
Contenitore x trasp stoviglie	464	Cuffia, TNT	169, 490	Forbice tutto servire	389
Contenitori isotermitici	469-470, 472	Cuoci riso a vapore	511	Forbice uva	389
Contenitori sovrapponibili	467-468	Cucivapore	264, 267	Forbice verdure	389
Coperchio bacinella gelato	291	Cutter da tavolo	503, 508	Forbici cucina	154-155
Coperchio cesto pane	418	<b>D</b>		Forbici cucina cinesi	268
Coperchio ciotole	424, 426	Densimetro x salamoia/sale	132	Forchetta a servire	390
Coperchio ermetico x ciotole	424	Detergente igienizzante	484	Forchetta insalata	92
Coperchio roll-top	288, 418, 421-423	Disidratatore	503	Forchetta lumache	392
Copertura igienica	414-415	Dispenser cuffie	491	Forchetta monoporzione	392
Copertura protettiva	463	Dispenser gel a pedale	490	Forchette fonduta	364
Copertura termica	473	Dispenser guanti	490-491	Forchettina 3 punte	91
Coperture monouso x carrelli	475	Dispenser kit visitatore	491	Forchettina ostriche	392
Coppa ananas	303	Dispenser mascherine	491	Forchettine aragosta	366
Coppa burro	356	Display per buffet	405-406	Forchettine lumache	366
Coppa caviale	366	Distributore bevande isoteramico	472	Forchettine monouso	331
Coppa champagne	303	Distributore cereali	430-431	Forchettine pralineria	181
Coppa crème brûlée	50	Distributore latte	431-432	Forchettone	93-94, 100, 153, 391
Coppa gelato	295	Distributore panini	415	Forchettone spaghetti	391
Coppa margarita	303	Distributore succhi	431-432	Forchettone unipezzo	98-99
Coppa martini	303	Distributore termico	432	Formaggiaria	361
Coppa mint julep	305	Dosa caffè	91	Forno microonde	512
Coppa punch	408	Dosa creme	195	Forno multifunzione	501
Coppa riso	257, 259	Dosatore	105-106	Friggitrice	501-502
Coppa soufflé	47	Dosatore miele/cremiera	285	Frullatore	510-511
Coppa spumante	314	Dosatrice per creme	195	Frullino	510-511
Coppa zucca	303			Frusta	100, 103, 82, 88, 94
Coppetta	296-298				
Coppetta sake	261				



**G**

Ganci macellaio	161
Gancio appendi borsa	367
Gastronorm acciaio inox	52-60
Gastronorm alluminio	59
Gastronorm antiaderenti	55
Gastronorm melamina	72-73
Gastronorm policarbonato	61-62
Gastronorm polipropilene	65-71
Gastronorm porcellana	74-77
Gastronorm smaltate	60
Gastronorm Tritan	63-64
Gel combustibile	449
Gel igienizzante	489
Gelateria, articoli	290-301
Girello	193
Glacette termica	367-368
Grattugia	90, 122-123
Grattugia 4 tagli	123
Grattugia automatica	118
Grattugia formaggio	86, 118
Grattugia noce moscata	123
Grattugia spatzie	123
Grattugia wasabi	268
Grembiule barman	325
Grembiule cotta di maglia	167
Grembiule LDPE	169, 489
Griglia di colaggio	194
Griglia di raffreddamento	194
Griglia Dim Sum	265
Griglia in filo	60
Griglia kebab/gyros	500
Griglia per cottura a vapore	265
Griglia per tempura	265
Griglia smaltata	60
Griglie pasticceria, inox	218
Griglie pasticceria, plastica	218-219
Grill a contatto	499
Guaina silicone, ISI	301
Guanti da forno	167-168
Guanti in lattice	168
Guanti monouso	489
Guanti scrub	168
Guanto anti taglio	168
Guanto in cotta di maglia	167

**I**

Imbuto	104-105
Imbuto colatore	195
Imbuto, ISI	301
Impastatrice planetaria	512
Iniettori/siringhe, ISI	301
Insacatrice	164
Insalatiera	357, 398
Inserti scaldavivande	447-448
Intaglia verdure	119

**JK**

Japanese jigger	311
Kit infusione rapida, ISI	301
Kit visitatore, TNT	169, 490

**L**

Laccetti da cucina	113
Lame panettiere	255
Lampada infrarossi	505
Lampada zucchero	196, 516
Lanterne	410
Lattiera cappuccino	286
Lattiera con coperchio	286
Legatovagliolo	362
Levacapsule	330
Levatorsoli	88, 91
Lira per formaggi	118
Lira per pan di Spagna	198

**M**

Macchina per cialde	504-505
Macchina per gelato	503
Macchina per raclette	363, 516
Macina erbe/peperoncino	384-385
Macina noce moscata	385-386
Macina pepe/sale	377-387
Macina per sale umido	383-384
Macina semi lino/sesamo	386
Macina/spargi cannella	386
Macinaerbe	124
Mandolino	119
Manico mop	483
Manico telescopico	483
Mannaietta formaggio	85, 89
Mantecatore burro	122
Marcatore pane Kaiser	255
Mascherine cacao	284
Mascherine monouso	489
Mestolino salsa	92
Mestolo	80-81, 92, 94, 100, 269, 391
Mestolo c/becco	99
Mestolo c/becco, unipezzo	98
Mestolo forato	81
Mestolo forato manico tubo	98
Mestolo forato unipezzo	98
Mestolo manico tubo	98
Mestolo pizza, fondo piatto	81, 279
Mestolo unipezzo	98-99
Mezzaluna	152-153
Miscelatori cocktail	308-309
Misurini	105
Misurino cocktail	311
Mixer	506-507
Molla asparagi	390
Molla frutta	389
Molla ghiaccio	320, 390
Molla insalata	80
Molla lumache	390
Molla pane	80, 390
Molla pasticceria	80
Molla spaghetti	80, 389
Molla toast	389
Molla tutto servire	389
Molla universale	389
Molla zucchero	390
Mop cotone	483-484
Mop microfibra	482
Mortaino c/pestello	268

Multi-distributore	428-429
--------------------	---------

**NO**

Nastro adesivo x sottovuoto	131
Nastro PVC	206
Nebulizzatore olio/acetato	360
Noccioli ceramica	205
Oliera	268, 271
Omogeneizzatore	508
Orologio da parete	134

**P**

Padella antiaderente	12, 22, 29, 30, 40, 266
Padella balti/karahi	266
Padella ferro	33, 265, -267
Padella giapponese	266
Padella Tamagoyaki	266
Padella Tawa	267
Padella Toban	266
Pala a ridurre	99
Pala manicata	274
Pala pasticcio	93, 96
Pala per patate fritte	101
Pala pizza	271-273
Pala torta	93, 193, 390
Paletta	269
Paletta angolare	79, 96
Paletta cenere	272
Paletta dolci	96
Paletta forata	81, 93-95, 100
Paletta forata unipezzo	99
Paletta fritti	80
Paletta liscia unipezzo	99
Paletta manico lungo	483
Paletta pesce unipezzo, forata	99
Paletta silicone	94
Pallet	487
Panni microfibra	484
Panno passabrodolo	112
Passapomodoro	124
Passathé	356
Passaverdura	111, 125
Passaverdura elettrico	124, 520
Passaverdura su supporto	124
Pasticceria, articoli	170-255
Pattumiera a pedale	485-487
Pedana	487
Pela arance	115
Pela mele	115
Pela verdure su supporto	114
Pela/svuota ananas	114
Pela/taglia avocado	117
Pelapatate	87, 91, 117
Pelapomodori	87
Pelarance	87, 91
Pelasparagi	87
Pelatrice elettrica	115, 503
Pelaverdure	117
Penna aerografa	196
Penna gesso liquido	292, 420
Pennarelli	71
Pennello	85, 90, 202
Pennello per wok	269
Pentola cinese	267

Pentola per riso dolce	264	Porta piatti	463	Runner	347
Pentolame 3-Ply	21-23, 434	Porta rotolo	104, 475	<b>S</b>	
Pentolame acciaio inox	ott-20	Porta snack	332-333	Sacchetto per decorare	191-192
Pentolame alluminio	27-31, 39	Porta tovaglioli	293	Sacco vinile	481
Pentolame ghisa smaltata	41-48	Portacandela	370-371	Salamandra	500
Pentolame rame	34-38	Portaciotole	424-426	Salinometro/termometro	133
Percolatore per caffè	445, 514	Portacombustibile	448	Salsiera	260, 356-357
Pesa sciropo/densimetro	132, 198	Portacondimenti	324, 362	Samovar	444-445, 514-515
Pesciera	25, 31, 38	Portagiornale	372	Saponetta togli odori	92
Pestaghiaccio	318	Portagrissini	361	Sbuccia melone	87
Petite marmite	440	Portaposate	361-362, 424	Sbucciatore a Y	87, 91
Pettine Charlotte	217	Portarifiuti da tavola	365	Sbucciatore lama mobile	91
Pettini decoratori	203	Portasigaro con piattino	373	Scalda wüstel	500
Peugeot	374-387	Portaspago	163	Scaldacaffè	443
Piano caldo	505	Portataglieri	167	Scaldacognac	369
Piastra induzione	438, 514	Portatoast	356	Scaldapiatti	502
Piastre elettriche	449	Portatovaglioli	287	Scaldavivande	436-443
Piattino degustazione	341-342	Portauovo	356	Scaletta pieghevole	487
Piattino fingerfood	395	Porzionatore	87, 91, 267, 292	Scalpellino ghiaccio	121
Piattino fondo	260, 351	Porzionatore riso	112	Scatola bento	259
Piattino piano	260, 366	Posacenero	372	Scatola portabustine thè	286
Piatto	258, 398, 401	Posacenero a colonna	488	Scavazucchine	86, 91
Piatto con campana	349	Posate caviale	366	Scavino	86, 91
Piatto frittura ghisa	267	Pressa bottiglie/lattine	125	Schiaccianoci	365
Piatto frutti di mare	366-367, 407	Pressa hamburger	164	Schiacciapate	117
Piatto lumache	366	Pressapatate	89-90	Schiuma detergente	488
Piatto pizza c/tagliere legno	275	Pressapolipo	113	Schiumarola	80-81, 93-94, 100, 269
Piatto servire sushi	259	Presse canard	113	Schiumarola a filo	101
Piatto torta	288-289	Provetta alimentare	198	Schiumarola a rete	100
Pietra per affilare	153	Pulizia & sicurezza, articoli	479-496	Schiumarola fritto	269
Pinza affettati	162	Pungisalame	160	Schiumarola unipezzo	99-100
Pinza aragosta	365	Puntale c/moschettone	496	Schiumarola Wonton	268
Pinza bar	309	<b>QR</b>		Sciabola per Sommelier	369
Pinza champagne	369	Quadri per ganache	199	Scolapiatti a muro	463
Pinza cucina	102-103	Raccoglibriciole	363	Scopa	483
Pinza grill	102	Raschia/tagliapasta	278-279	Scopa + alza immondizia	482
Pinza per anatra	268	Raschietti	202-203	Scopa a forbice	482
Pinza per mop	483	Raschietti decorativi	292	Scopa spingiacqua	483
Pinza servire	80, 102-103	Raschietto ceppa	167	Scovolini per cannuce	307
Pinza teglie	274	Rastelliera teglie pizza	280	Secchio ghiaccio	320, 472
Pinza togli lische	102	Rastrelliera	103, 326	Secchio graduato	109, 485
Pirofila ovale	397	Rastrelliera porta bicchieri	326	Secchio portabottiglie	408
Pistola elettrica	196, 517	Rastrelliera retine pizza	280	Secchio vino	367
Pizza, articoli	270-282	Rastrello	272	Sega per ossa	163
Pizzi sottotorta	193	Rechaud	364-365	Seggiolone	480
Placca biscotti	219	Recipiente multiuso	463	Segnagusto	293
Plancia	348-349, 400	Reggi caramellometro	198	Segnalatore telescopico	484
Plancia a servire	335-337	Retina pizza	280	Segnaporzioni	201
Pompa sottovuoto per vino	330	Ricambi	525-533	Senapiera	356
Pompetta per sugo	102	Ricariche sifone panna, ISI	301	Separatore GN	60
Pompetta terminale in rame	197	Ricariche sifone panna, Kayser	300	Separauova	92
Ponte sushi/sashimi	259	Ricariche sifone soda, ISI	318	Servispaghetti	93-94
Porta Brezel	414	Riga	198	Servitartufi	359
Porta bustine zucchero	286	Rigalimoni	88, 92	Servizio caffè	287, 338
Porta cannuce	286	Riscaldi sake	261	Servizio oliera	360-361
Porta coltelli	160	Rompighiaccio	318	Sessola	107
Porta coni	294-295	Rotella taglia pasta	84, 88, 200	Sessola ghiaccio	318
Porta coni da banco	293	Rotella taglia pizza	84, 88, 274	Set aperitivo/degustazione	333-334
Porta coppette	340	Rotolo portacoltelli	159	Set cottura riso dolce	264
Porta cucchiaini	286	Rullo	201	Setaccio	107, 203
Porta menù	371	Rullo bucasfoglia	200	Sgocciolatore	237
Porta oggetti bar	320	Rullo losanghe	200	Shaker	311
Porta olio/acetato	361	Rullo tagliapasta	200, 202	Sifone nitro, ISI	284
Porta pale	273				
Porta palette/coppette	294				

Sifone panna, ISI	300	Stiletto aragosta	365	Targhetta tavola	371
Sifone panna, Kayser	300	Stiletto thailandese	121	Tastevin	369
Sifone soda, ISI	317	Stoccaggio & trasporto, articoli	459-478	Tavola, articoli	345-387
Sifone termico, ISI	300	Stoneware	40	Tavolino con box termico	474
Siringa per marinata	102	Stuoietta sushi	263	Tavolino room service	457-458
Siringa per pasticceria	192	Stuzzicadenti	331	Tazza Cola	305
Sistema di pulizia, kit Pulse	482	Supporto bacchette cinesi	262	Tazza julep	306
Sottopentola	44, 365	Supporto bottiglie a parete	326	Tazza moscow mule	303-305
Souffl�	50	Supporto bottiglie rotante	326	Tazza soba choko	259
Spade	161	Supporto buffet	394	Tea light led	371
Spalmaburro	85, 90	Supporto chafing dish	447	Tegame rettangolare	25, 30-31, 38, 44
Spargicacao	285	Supporto girevole	349	Tegamino uova	50
Spargiformaggio	361	Supporto in filo	419-420	Teglia forata, alluminio	194, 282
Spargisale/pepe	360-361	Supporto mobile	466	Teglia forata, antiaderente	280, 282
Spargizucchero	203, 285	Supporto murale pellicola	104	Teglia forata, siliconata	195
Spatola	79-81, 90, 93, 96, 101	Supporto murale per gel	490	Teglia monoporzioni	220
Spatola gelato	291	Supporto numero tavola	371	Teglia pizza, antiaderente	280
Spatola hamburger	96	Supporto per abbattitore	298	Teglia pizza, ferro blu	280-281
Spatola pasticcio e pizza	96	Supporto per cottura a vapore	265	Teglia, all siliconato	205
Spatola per biscuit	198	Supporto per temaki	260	Teglia, all siliconato, forato	205
Spatola per stemperare	79	Supporto piatto frutti mare	366	Teglia, alluminio	194, 280-282
Spatola resina	103	Supporto porta vasetti	353	Teglia, alluminio	194, 282
Spatole cr�pes	101	Supporto secchio da tavola	367	Teglia, antiaderente	195, 282
Spatolina burro	391	Supporto targhetta	371	Teglia, siliconata	195
Spazzola forno pizza	272-273	Svuota ananas	86, 115	Telai torte	207-209
Spazzola grill	103	Svuota carciofi	116	Telaio pieghevole	480
Spazzola pane	255			Telaio regolabile	207
Spazzola per ceppa	165	<b>T</b>		Temperatrice	197, 299-300, 517
Spazzola per griglia	273	Tabella x aste separa corsie	495	Temperino verdure	85
Spazzola per wok	269	Taglia ananas	115	Termoigrometro	132
Spazzole lavabicchieri	326	Taglia capsula	329	Termometri	127-133, 285
Specchio buffet	409-410	Taglia cavolini di Bruxelles	116	Termometro IR frontale	489
Spelucchino	89	Taglia croissants	201	Termometro zucchero	197
Spiedini	161, 262, 330	Taglia cubi	114	Termoregolatore	449
Spiedini cocktail	331	Taglia funghi	117	Testate pela verdure	114
Spillone portascontrini	103	Taglia pane	415	Tester oli di frittura	133
Spremiaglio	90, 118	Taglia patate	117	Tiki mug in ceramica	307
Spremiagrumi elettrico	509-511	Taglia ricci di mare	365	Tiki mug teschio in vetro	306
Spremiagrumi manuale	317	Taglia tortillas	118	Timer	132
Spremilimone	317	Taglia uova	115-116	Tortiere, alluminio	210
Squamapesce	84-85, 89, 269	Tagliapasta con espulsore	180-181	Tortiere, antiaderenti	212-217
Stampi mini push up pops	299	Tagliapasta estensibile	200	Tostapane	498
Stampi natalizi	231	Tagliapasta, inox	171-179	Tovaglietta	347
Stampi pasquali	231	Tagliapasta, PA+	180	Trancia spicchi	114-115
Stampi, silicone	232-253	Tagliasigari da tavola	373	Trincipollo	154
Stampo Bordelais	38	Tagliatartufi	359	Tritacarne	518
Stampo burro	122	Tagliaverdura turn'up	119	Tritaghiaccio	318
Stampo cioccolato magnetico	228	Tagliaverdure	88, 114	Tritaghiaccio automatico	510-511
Stampo cioccolato, PC	222-229	Tagliaverdure elettrico	507	Tronchetto tagliapizza	274
Stampo cioccolato, silicone	221	Tagliaverdure ghirlanda	115		
Stampo decora crostate	201	Tagliaverdure spiralizzatore	120-121	<b>UV</b>	
Stampo gelato	298-299	Tagliere a servire	400	Utensili da cucina	78-136
Stampo ghiaccio	318-319	Tagliere con vasca	165-167	Utensili decoro	121
Stampo mooncake	263	Tagliere pane	414	Utensili marzapane	181
Stampo nigiri/maki	263	Tagliere servizio, legno	337-340	Valigia barman	325
Stampo pane	254	Tagliere sup porcellanata	339	Valigia cuoco	158
Stampo panzerotti	124	Tagliere sushi	259	Vaporiera	512
Stampo per tronco	217	Tampone finto legno	217	Vasca di drenaggio	466
Stampo uovo	230	Tappetino bar	324	Vasca riso hangiri	264
Stand per vassoio	411	Tappeto silicone	204	Vasetti con coperchio	352-353
Stand porta gel/guanti	490	Tappeto sottobicchieri	324	Vaso conserva tartufo	359
Stazione igiene mani	488	Tappo spumante	328	Vaso fiori	369
Stencils	221	Tappo versatore dosatore	327-328	Vaso porta sacchetto	193
Stendipasta	198	Tappo vino	328	Vaso soia	261
Sterilizzatore	160, 520				

Vassoio bento	259
Vassoio con coperchio	299
Vassoio con gambe	455
Vassoio conto	287
Vassoio espositore	163, 204
Vassoio Euronorm	475
Vassoio fast food	474
Vassoio Gastronorm	475
Vassoio Gourmet	296
Vassoio macelleria	163
Vassoio portatovagliolo	259
Vassoio rettangolare	163
Vassoio reversibile	259
Vassoio room service	455
Vassoio sushi	396
Vassoio zarusoba	259
Vassoio, inox	411-412
Vassoio, MF	257-258, 350-351, 395-396, 399, 402-404
Versatore vino	369
Versavino	369
Vetrina	421-422
Vetrina antipasti	503
Vetrina brioches	287
Vetrina refrigerata	423
Vetrina riscaldata	502
Vetrina sigari	373
Visiera facciale	489

## WZ

Wok	22, 33, 43, 264-265
Zuppiera	445-446, 516
Zuppiera testa di leone	357

**NUMERICAL INDEX**

INDICE NUMERICO

NUMERISCH INDEX

INDEX NUMERIQUE

INDICE NUMERICO

Cod.	pag.	Cod.	pag.	Cod.	pag.	Cod.	pag.	Cod.	pag.	Cod.	pag.	Cod.	pag.
11001-16	15	11009-45	15	11101-50	11	11112-24	12	11161-50	12	11716-36	33	11742-60	281
11001-18	15	11009-50	15	11102-28	11	11113-18	12	11161-60	12	11716-40	33	11744-20	280
11001-20	15	11009-60	15	11102-32	11	11113-20	12	11617-20	29	11716-45	33	11744-24	280
11001-22	15	11010-16	15	11102-36	11	11113-24	12	11617-24	29	11717-34	33	11744-28	280
11001-24	15	11010-18	15	11102-40	11	11113-26	12	11617-28	29	11717-37	33	11744-32	280
11001-28	15	11010-20	15	11102-45	11	11114-20	12	11617-32	29	11717-42	33	11750-11	60
11001-32	15	11010-24	15	11102-50	11	11114-24	12	11701-02	271	11717-47	33	11760-11	60
11001-36	15	11011-16	16	11102-99	525	11114-28	12	11701-06	271	11718-20	33	11910-12	26
11001-40	15	11011-18	16	11105-16	11	11114-32	12	11701-10	271	11718-22	33	11910-14	26
11001-45	15	11011-20	16	11105-20	11	11114-36	12	11701-13	271	11718-24	33	11910-16	26
11001-50	15	11011-24	16	11105-24	11	11114-40	12	11701-16	271	11721-28	33	11910-18	26
11001-60	15	11012-16	15	11105-28	11	11114-45	12	11702-02	271	11739-20	280	11910-20	26
11006-12	16	11012-18	15	11105-32	11	11115-20	12	11702-06	271	11739F20	521	11911-12	26
11006-14	16	11012-20	15	11105-36	11	11115-24	12	11702-10	271	11739-24	280	11911-14	26
11006-16	16	11012-24	15	11105-40	11	11115-28	12	11702-16	271	11739F24	521	11911-16	26
11006-18	16	11013-18	15	11106-14	11	11115-32	12	11704-02	271	11739-28	280	11911-18	26
11006-20	16	11013-20	15	11106-16	11	11115-36	12	11704-06	271	11739F28	521	11911-20	26
11006-22	16	11013-24	15	11106-20	11	11115-40	12	11704-13	271	11739-32	280	11913-16	26
11006-24	16	11013-26	15	11106-24	11	11115-45	12	11704-16	271	11739F32	521	11913-20	26
11006-28	16	11014-20	16	11106-28	11	11115-50	12	11705-02	271	11740-14	281	11913-24	26
11006-32	16	11014F20	521	11106-32	11	11117-20	12	11705-06	271	11740-16	281	11913-28	26
11006-36	16	11014-24	16	11106-36	11	11117-24	12	11705-10	271	11740-18	281	11922-36	26
11007-16	15	11014F24	521	11107-16	11	11117-28	12	11705-14	271	11740-20	281	11922-40	26
11007-18	15	11014-28	16	11107-20	11	11117-32	12	11706-02	271	11740-22	281	11924-18	109
11007-20	15	11014F28	521	11107-24	11	11117-36	12	11706-06	271	11740-24	281	11924-20	109
11007-22	15	11014-32	16	11107-28	11	11117-40	12	11706-10	271	11740-26	281	11924F20	521
11007-24	15	11014F32	521	11107-32	11	11119-20	11	11706-14	271	11740-28	281	11924-22	109
11007-28	15	11014-36	16	11107-36	11	11119-24	11	11710-AA	33	11740-30	281	11924-24	109
11007-32	15	11014-40	16	11107-40	11	11119-28	11	11710-AB	33	11740-32	281	11924-28	109
11007-36	15	11061-12	16	11107-45	11	11119-32	11	11713-32	33	11740-36	281	11926-22	109
11007-40	15	11061-16	16	11107-50	11	11123-20	11	11713-40	33	11740-40	281	11926-26	109
11007-45	15	11061-18	16	11108-16	12	11123-24	11	11714-20	33	11741-20	280	11927-24	108
11007-50	15	11061-20	16	11108-20	12	11123-28	11	11714-22	33	11741-24	280	11927-28	108
11007-60	15	11061-22	16	11108-24	12	11161-12	12	11714-24	33	11741-26	280	11927-32	108
11008-16	16	11061-24	16	11108-28	12	11161-14	12	11714-26	33	11741-28	280	11927-36	108
11008-18	16	11061-28	16	11108-32	12	11161-16	12	11714-28	33	11741-32	280	11927-40	108
11008-20	16	11061-32	16	11108-36	12	11161F16	521	11714-32	33	11742-16	281	11927-45	108
11008-24	16	11061-36	16	11109-16	11	11161-18	12	11714-36	33	11742-18	281	11927-50	108
11008-28	16	11061-40	16	11109-20	11	11161-20	12	11714-40	33	11742-20	281	11928-32	108
11008-32	16	11061-45	16	11109-24	11	11161F20	521	11714-45	33	11742-22	281	11928-36	108
11008-36	16	11061-50	16	11109-28	11	11161-22	12	11714-50	33	11742-24	281	11928-40	108
11009-16	15	11101-16	11	11109-32	11	11161-24	12	11715-12	33	11742-26	281	11929-20	112
11009-18	15	11101-20	11	11109-36	11	11161F24	521	11716-16	33	11742-28	281	11929-24	112
11009-20	15	11101-24	11	11109-40	11	11161-28	12	11716-20	33	11742-30	281	11930-24	108
11009-24	15	11101-28	11	11109-45	11	11161F28	521	11716-22	33	11742-32	281	11930F24	521
11009-28	15	11101-32	11	11109-50	11	11161-32	12	11716-24	33	11742-36	281	11930-28	108
11009-32	15	11101-36	11	11112-16	12	11161-36	12	11716-26	33	11742-40	281	11930-32	108
11009-36	15	11101-40	11	11112-18	12	11161-40	12	11716-28	33	11742-45	281	11930-36	108
11009-40	15	11101-45	11	11112-20	12	11161-45	12	11716-32	33	11742-50	281	11930-40	108

**NUMERICAL INDEX INDICE NUMERICO NUMERISCH INDEX INDEX NUMERIQUE INDICE NUMERICO**

Cod.	pag.	Cod.	pag.	Cod.	pag.	Cod.	pag.	Cod.	pag.	Cod.	pag.	Cod.	pag.
11930-45	108	11957-20	108	11971-20	99	12007-32	18	12123F20	522	12511-24	22	12550-54	390
11930-50	108	11957-25	108	11971-25	99	12007-36	18	12123F24	522	12513-16	22	12550-55	325
11932-20	112	11957-30	108	11972-10	99	12007-40	18	12123F28	522	12513-18	22	12550-56	390
11932-24	112	11957-35	108	11972-12	99	12007-45	18	12300-18	434	12513-20	22	12550-58	389
11941-35	25	11957-40	108	11973-01	99	12007-50	18	12300B18	435	12513-24	22	12550-60	390
11941-40	25	11963-99	25	11973-10	99	12007-60	18	12300G18	435	12514-20	23	12550-62	390
11941-45	25	11965-50	25	11973F10	522	12009-16	18	12300O18	435	12514-24	22	12550-63	390
11941-50	25	11965-60	25	11973-12	99	12009-18	18	12300W18	434	12514-26	22	12550-64	390
11941-60	25	11965-61	25	11973F12	522	12009-20	18	12300Y18	435	12514-28	22	12550-66	390
11943-40	25	11966-50	525	11974-50	98	12009-24	18	12300-24	434	12514-32	22	12550-68	389
11943-45	25	11966-60	525	11974-70	98	12009-28	18	12300B24	435	12514-36	22	12550-69	389
11943-50	25	11966-61	525	11975-01	99	12009-32	18	12300G24	435	12517-24	22	12550-70	389
11943-60	25	11967-06	98	11975-50	99	12009-36	18	12300O24	435	12517-26	22	12550-73	389
11943-61	25	11967-08	98	11975-99	99	12009-40	18	12300W24	434	12517-28	22	12550-74	389
11944-40	25	11967-09	98	11976-50	99	12009-45	18	12300Y24	435	12517-32	22	12550-77	389
11944-45	25	11967-10	98	11976-99	99	12009-50	18	12303B16	434	12517-36	22	12550-78	389
11944-50	25	11967-12	98	11982-01	99	12009-60	18	12303G16	434	12529-32	22	12550-79	389
11944-60	25	11967-14	98	11982-38	98	12037-16	18	12303O16	434	12550-01	391	12550-80	389
11944-61	25	11967-16	98	11982F38	522	12101-16	13	12303W16	434	12550-02	390	12550-81	389
11948-40	25	11967-18	98	11983-37	98	12101-20	13	12303Y16	434	12550-03	392	12550-83	389
11948-45	25	11967-20	98	11983-38	98	12101-24	13	12303B20	434	12550-04	318	12550-84	389
11948-50	25	11967-24	98	11984-38	98	12101-28	13	12303G20	434	12550-05	392	12550-85	389
11948-60	25	11968-18	98	11985-34	99	12101-32	13	12303O20	434	12550-06	392	12550-87	389
11948-61	25	11968-20	98	11990-16	100	12101-36	13	12303W20	434	12550-07	392	12550-88	389
11951-22	110	11968-24	98	11991-16	100	12101-40	13	12303Y20	434	12550-09	392	12550-89	389
11951-26	110	11969-02	99	12001-16	18	12101-45	13	12303B24	434	12550-11	390	12550-91	389
11951-32	110	11969-06	98	12001-18	18	12101-50	13	12303G24	434	12550-12	390	12561-12	23
11951-36	110	11969-37	98	12001-20	18	12107-16	13	12303O24	434	12550-13	390	12561-16	23
11951-40	110	11970-01	99	12001F20	522	12107-20	13	12303W24	434	12550-14	390	12561-18	23
11952-22	110	11970-06	98	12001-22	18	12107-24	13	12303Y24	434	12550-15	391	12561-20	23
11952-26	110	11970F06	522	12001-24	18	12107-28	13	12304B26	434	12550-16	391	12561-24	23
11952-32	110	11970-08	98	12001F24	522	12107-32	13	12304G26	434	12550-17	391	12561-26	23
11952-36	110	11970F08	522	12001-28	18	12107-36	13	12304O26	434	12550-18	391	12561-28	23
11952-40	110	11970-09	98	12001F28	522	12107-40	13	12304W26	434	12550-19	392	12580-11	108
11953-16	110	11970-10	98	12001-32	18	12107-45	13	12304Y26	434	12550-20	391	12580-17	108
11953-22	110	11970F10	522	12001-36	18	12107-50	13	12504-20	103	12550-21	391	12580-21	108
11954-26	110	11970-11	98	12001-40	18	12109-16	13	12507-24	22	12550-22	390	12580-24	108
11954-30	110	11970-12	98	12001-45	18	12109-20	13	12507-28	22	12550-23	390	12580-29	108
11954-32	110	11970-14	98	12001-50	18	12109-24	13	12508-24	22	12550-24	391	12580-30	108
11954-36	110	11970-16	98	12001-60	18	12109-28	13	12509-12	23	12550-25	391	12580-31	108
11954-37	110	11971-01	100	12007-16	18	12109-32	13	12509-20	22	12550-26	391	12580-36	108
11954-40	110	11971-08	99	12007F16	522	12109-36	13	12509-24	22	12550-30	391	12580-40	108
11955-32	108	11971-10	99	12007-18	18	12109-40	13	12509-28	22	12550-33	391	12580-45	108
11955-36	108	11971F10	522	12007-20	18	12109-45	13	12511-10	23	12550-34	390	12580-50	108
11955-40	108	11971-12	99	12007-22	18	12109-50	13	12511-12	23	12550-36	325	12582-13	108
11955-45	108	11971F12	522	12007-24	18	12119-20	18	12511-14	23	12550-37	391	12582-17	108
11955-50	108	11971-14	99	12007F24	522	12119-24	18	12511-16	22	12550-43	392	12582-22	108
11956-37	408	11971-16	99	12007-28	18	12119-28	18	12511-18	22	12550-50	389	12582-24	108
11956-42	408	11971-18	99	12007F28	522	12119-32	18	12511-20	22	12550-53	390	12582-32	108

Cod.	pag.	Cod.	pag.	Cod.	pag.	Cod.	pag.	Cod.	pag.	Cod.	pag.	Cod.	pag.
12582-34	108	12642-28	101	12929-30	82	12947-04	180	14101-20	52	14107-20	53	14151-15	55
12582-38	108	12903-30	79	12929F30	523	12947-05	180	14102-02	52	14107F20	523	14151-20	55
12582-40	108	12903-40	79	12929-35	82	12947-06	180	14102F02	523	14108-06	53	14152-06	55
12604-22	107	12903-45	79	12929F35	523	12947-07	180	14102-04	52	14108F06	523	14152-10	55
12604-30	107	12905-25	79	12929-40	82	12947-13	180	14102F04	523	14108-10	53	14152-15	55
12604-34	107	12905-30	79	12929-45	82	12950-32	82	14102-06	52	14108F10	523	14152-20	55
12604-40	107	12905-35	79	12930-51	80	12950-40	82	14102F06	523	14108-15	53	14155-10	55
12605-22	107	12905-40	79	12930-52	80	12967-06	81	14102-10	52	14108F15	523	14155-15	55
12605-30	107	12905-45	79	12930-62	80	12967-10	81	14102F10	523	14108-20	53	14155-20	55
12605-34	107	12905-50	79	12930-63	80	12968-10	81	14102-15	52	14108F20	523	14157-10	55
12605-40	107	12906-35	79	12930-68	80	12969-06	81	14102F15	523	14109-06	53	14157-15	55
12606-30	107	12907-07	79	12930-69	80	12969-10	81	14102-20	52	14109F06	523	14157-20	55
12606-34	107	12907-08	79	12930-74	80	12970-06	81	14102F20	523	14109-10	53	14158-10	55
12607-22	107	12908-30	79	12930-77	80	12970-08	81	14103-02	53	14109F10	523	14158-15	55
12607-30	107	12908-35	79	12930-78	80	12970-10	81	14103F02	523	14109-15	53	14158-20	55
12607-34	107	12908-40	79	12931-51	81	12970-12	81	14103-04	53	14109F15	523	14159-10	55
12622-07	111	12909-12	79	12931-53	81	12971-10	81	14103F04	523	14109-20	53	14159-15	55
12622-10	111	12909-23	79	12932-22	82	12971-12	81	14103-06	53	14109F20	523	14159-20	55
12622-12	111	12915-25	79	12932-26	82	12972-10	81	14103F06	523	14110-06	53	14162-02	55
12622-14	111	12915-26	79	12940-02	107	12972-12	81	14103-10	53	14110F06	523	14162-04	55
12622-16	111	12915-35	79	12940-05	107	12973-10	81	14103F10	523	14110-10	53	14162-06	55
12622-18	111	12915-45	79	12940-10	107	12973-12	81	14103-15	53	14110F10	523	14165-02	55
12622-20	111	12916-25	79	12940-20	107	12986-01	81	14103F15	523	14112-10	53	14165-04	55
12622-23	111	12916-33	79	12940-25	107	12986-38	81	14103-20	53	14112-15	53	14165-06	55
12622-26	111	12917-25	79	12941-07	82	12992-36	26	14103F20	523	14112-20	53	14201-02	56
12630-22	111	12920-01	80	12941-10	82	12992-40	26	14104-06	53	14115-10	54	14201-04	56
12633-16	111	12920-05	80	12941-12	82	14001-09	460	14104F06	523	14115-15	54	14201-06	56
12633-18	111	12920-10	80	12941-14	82	14001-16	460	14104-10	53	14115-20	54	14201-10	56
12633-20	111	12920-11	80	12941-16	82	14001-25	460	14104F10	523	14117-10	54	14201-15	56
12633-23	111	12920-15	80	12941-18	82	14001-36	460	14104-15	53	14117-15	54	14201-20	56
12633-26	111	12920-16	80	12941-20	82	14001-49	460	14104F15	523	14117-20	54	14202-02	56
12635-23	111	12921-01	79	12941-23	82	14003-09	460	14105-02	53	14118-10	54	14202-04	56
12635-26	111	12921-05	79	12941-26	82	14003-16	460	14105F02	523	14118-15	54	14202-06	56
12635-30	111	12921-10	79	12943-03	112	14003-25	460	14105-04	53	14118-20	54	14202-10	56
12635-35	111	12921-15	80	12943-05	112	14003-36	460	14105F04	523	14119-10	54	14202-15	56
12636-32	111	12926-35	82	12943-07	112	14003-49	461	14105-06	53	14119-15	54	14202-20	56
12638-20	111	12927-35	82	12943-08	112	14004-00	461	14105F06	523	14142-10	54	14203-06	56
12640-14	101	12927-45	82	12943-10	112	14006-00	461	14105-10	53	14142-15	54	14203-10	56
12640-16	101	12928-25	82	12943-12	112	14007-00	461	14105F10	523	14142-20	54	14203-15	56
12640-18	101	12928-30	82	12943-13	180	14008-00	461	14105-15	53	14145-10	54	14203-20	56
12640-20	101	12928F30	522	12944-03	112	14010-00	461	14105F15	523	14145-15	54	14205-02	56
12640-24	101	12928-35	82	12944-05	112	14011-00	461	14105-20	53	14145-20	54	14205-04	56
12640-28	101	12928F35	522	12944-07	112	14013-00	461	14105F20	523	14147-10	54	14205-06	56
12641-14	101	12928-40	82	12944-08	112	14015-08	461	14107-06	53	14147-15	54	14205-10	56
12641-16	101	12928-45	82	12944-10	112	14101-02	52	14107F06	523	14147-20	54	14205-15	56
12641-18	101	12928-50	82	12944-12	112	14101-04	52	14107-10	53	14148-10	54	14205-20	56
12641-20	101	12928-55	82	12944-13	180	14101-06	52	14107F10	523	14148-15	54	14252-06	56
12641-24	101	12928-60	82	12947-02	180	14101-10	52	14107-15	53	14148-20	54	14252-10	56
12641-28	101	12929-25	82	12947-03	180	14101-15	52	14107F15	523	14151-10	55	14252-15	56



**NUMERICAL INDEX INDICE NUMERICO NUMERISCH INDEX INDEX NUMERIQUE INDICE NUMERICO**

Cod.	pag.	Cod.	pag.	Cod.	pag.	Cod.	pag.	Cod.	pag.	Cod.	pag.	Cod.	pag.
14252-20	56	14519-00	57	14579-00	62	14702-10	66	14729-33	67	14958-02	318	15343-36	38
14255-06	56	14522-00	57	14580-00	62	14702-15	66	14729-99	67	15100-01	71	15401-51	38
14255-10	56	14523-00	57	14585-00	62	14702-20	66	14730-00	67	15100-02	71	15403-16	38
14255-15	56	14525-00	57	14591-00	62	14705-06	66	14730-11	67	15100-03	71	15406-16	38
14255-20	56	14527-00	57	14592-00	62	14705-10	66	14730-22	67	15100-04	71	15406-20	38
14301-02	58	14528-00	57	14595-00	62	14705-15	66	14730-33	67	15100-07	71	15407-16	38
14301-04	58	14529-00	57	14597-00	62	14705-20	66	14730-99	67	15100-AA	71	15407-20	38
14301-06	58	14532-00	57	14598-00	62	14707-06	66	14912-00	69	15101-06	69	15409-26	38
14302-02	58	14535-00	57	14599-00	62	14707-10	66	14915-00	69	15101-10	69	15409-30	38
14302-04	58	14537-00	57	14661-20	63	14707-15	66	14922-00	70	15101-15	69	15409-36	38
14302-06	58	14538-00	57	14662-06	63	14707-20	66	14922-11	70	15101-20	69	15415-03	38
14303-02	58	14539-00	57	14662-10	63	14708-06	66	14922-22	70	15105-06	69	15428-06	364
14303-04	58	14542-00	57	14662-15	63	14708-10	66	14922-33	70	15105-10	69	15430-11	38
14303-06	58	14543-00	57	14662-20	63	14708-15	66	14922-77	70	15105-15	69	15438-50	38
14305-02	58	14545-00	57	14665-06	63	14708-20	66	14922-99	70	15105-20	69	15506-16	35
14305-04	58	14547-00	57	14665-10	63	14709-06	66	14925-00	70	15107-06	69	15506-20	35
14305-06	58	14548-00	57	14665-15	63	14709-10	66	14925-11	70	15107-10	69	15506-24	35
14362-02	58	14549-00	57	14665-20	63	14709-15	66	14925-22	70	15107-15	69	15506-28	35
14362-04	58	14552-00	58	14667-06	64	14709-20	66	14925-33	70	15107-20	69	15507-16	35
14362-06	58	14555-00	58	14667-10	64	14710-06	66	14925-77	70	15108-06	69	15507-20	35
14365-02	58	14561-15	61	14667-15	64	14710-10	66	14925-99	70	15108-10	69	15507-24	35
14365-04	58	14561-20	61	14667-20	64	14712-00	66	14927-00	70	15108-15	69	15507-28	35
14365-06	58	14562-06	61	14668-06	64	14715-00	66	14927-11	70	15108-20	69	15508-20	35
14402-00	60	14562-10	61	14668-10	64	14717-00	66	14927-22	70	15109-06	69	15508-24	35
14405-00	60	14562-15	61	14668-15	64	14718-00	66	14927-33	70	15109-10	69	15508-28	35
14407-00	60	14562-20	61	14668-20	64	14719-00	66	14927-77	70	15109-15	69	15509-20	35
14409-01	60	14565-06	61	14669-06	64	14722-00	67	14927-99	70	15109-20	69	15509-24	35
14409-02	60	14565-10	61	14669-10	64	14722-11	67	14928-00	70	15110-06	69	15509-28	35
14480-20	325	14565-15	61	14669-15	64	14722-22	67	14928-11	70	15110-10	69	15514-20	35
14502-00	57	14565-20	61	14669-20	64	14722-33	67	14928-22	70	15224-10	36	15514-24	35
14502F00	523	14567-06	62	14670-06	64	14722-99	67	14928-33	70	15224-12	36	15514-28	35
14503-00	57	14567-10	62	14670-10	64	14725-00	67	14928-77	70	15224-14	36	15514-32	35
14503F00	523	14567-15	62	14671-00	64	14725-11	67	14928-99	70	15225-10	36	15515-20	35
14504-00	57	14567-20	62	14672-00	64	14725-22	67	14929-00	70	15225-12	36	15515-24	35
14504F00	523	14568-06	62	14675-00	64	14725-33	67	14929-11	70	15225-14	36	15515-28	35
14505-00	57	14568-10	62	14677-00	64	14725-99	67	14929-22	70	15226-07	36	15515-32	35
14505F00	523	14568-15	62	14678-00	64	14727-00	67	14929-33	70	15226-10	36	15561-20	35
14507-00	57	14568-20	62	14679-00	64	14727-11	67	14929-77	70	15226-12	36	15561-24	35
14507F00	523	14569-06	62	14680-00	64	14727-22	67	14929-99	70	15226-14	36	15561-28	35
14508-00	57	14569-10	62	14682-00	64	14727-33	67	14930-00	70	15227-10	36	16101-16	28
14508F00	523	14569-15	62	14685-00	64	14727-99	67	14930-11	70	15227-12	36	16101-20	28
14509-00	57	14569-20	62	14687-00	64	14728-00	67	14930-22	70	15227-14	36	16101-24	28
14509F00	523	14570-06	62	14688-00	64	14728-11	67	14930-33	70	15228-10	36	16101-28	28
14510-00	57	14570-10	62	14689-00	64	14728-22	67	14930-77	70	15229-10	36	16101-32	28
14510F00	523	14571-00	62	14690-00	64	14728-33	67	14930-99	70	15261-10	36	16101-36	28
14512-00	57	14572-00	62	14691-00	64	14728-99	67	14942-99	69	15261-12	36	16101-40	28
14515-00	57	14575-00	62	14692-00	64	14729-00	67	14945-99	69	15261-14	36	16101-45	28
14517-00	57	14577-00	62	14695-00	64	14729-11	67	14947-99	69	15338-38	38	16101-50	28
14518-00	57	14578-00	62	14702-06	66	14729-22	67	14958-01	318	15339-36	38	16106-16	28

Cod.	pag.	Cod.	pag.	Cod.	pag.	Cod.	pag.	Cod.	pag.	Cod.	pag.	Cod.	pag.
16106-20	28	16117-36	29	16910-14	31	16948-40	30	18000B30	141	18006R30	143	18015-27	145
16106-24	28	16117-40	29	16910-16	31	16948-45	30	18000G30	141	18006Y30	143	18015Y27	145
16106-28	28	16118-24	30	16910-18	31	16948-50	30	18000R30	141	18006-36	143	18016-14	145
16107-16	28	16120-24	29	16910-20	31	16948-60	30	18000W30	141	18007-25	143	18016B14	145
16107-20	28	16120-28	29	16923-32	28	16948-61	30	18000-36	141	18007-30	143	18016R14	145
16107-24	28	16120-32	29	16923-36	28	16961-16	29	18002-18	142	18007G30	143	18016Y14	146
16107-28	28	16120-36	29	16923-40	28	16961-20	29	18002R18	142	18007-36	143	18016-16	145
16107-32	28	16120-40	29	16924-20	109	16961-24	29	18002Y18	142	18008-20	143	18016B16	145
16107-36	28	16127-16	29	16924-24	109	16961-28	29	18002-20	142	18008-26	143	18016R16	145
16107-40	28	16127-20	29	16924-28	109	16961-32	29	18002R20	142	18008R26	143	18016W16	146
16107-45	28	16127-24	29	16926-32	28	16961-36	29	18002-22	142	18008-30	143	18016Y16	146
16107-50	28	16127-28	29	16926-36	28	16961-40	29	18002R22	142	18008B30	143	18017-14	146
16108-20	28	16127-32	29	16926-40	28	16961-45	29	18002-26	142	18008R30	143	18017-16	146
16108-24	28	16127-36	29	16927-32	108	16961-50	29	18002B26	142	18008Y30	144	18017B16	146
16108-28	28	16127-40	29	16927-36	108	16961-60	29	18002R26	142	18008-36	143	18017R16	146
16109-24	28	16134-12	39	16927-40	108	16965-40	31	18002Y26	142	18008R36	143	18017Y16	146
16109-28	28	16135-12	39	16927-45	108	16965-50	31	18002-30	142	18009-25	144	18017-18	146
16109-32	28	16136-10	39	16927-50	108	16965-60	31	18002R30	142	18009B25	144	18018-11	146
16109-36	28	16137-10	39	16929-36	31	17610-01	107	18002Y30	142	18009G25	144	18018R11	146
16109-40	28	16138-10	39	16929-40	31	17610-02	107	18002-36	142	18009M25	144	18018Y11	146
16109-45	28	16139-10	39	16938-36	28	17610-05	107	18002R36	142	18009R25	144	18019-12	146
16109-50	28	16302-02	59	16938-40	28	17610-10	107	18002Y36	142	18009W25	144	18019R12	146
16109-60	28	16302-04	59	16938-45	28	18000-16	141	18005-22	141	18009Y25	144	18019-14	146
16113-20	30	16302-06	59	16939-50	31	18000B16	141	18005B22	142	18009-30	144	18019-16	146
16113-24	30	16303-02	59	16939-60	31	18000G16	141	18005G22	142	18009B30	144	18019R16	146
16113-28	30	16303-04	59	16939-70	31	18000M16	141	18005R22	142	18009G30	144	18019-18	146
16113-32	30	16303-06	59	16939-80	31	18000R16	141	18005Y22	142	18009R30	144	18019R18	146
16113-36	30	16305-02	59	16940-28	210	18000Y16	141	18005-27	141	18009W30	144	18019-20	146
16113-40	30	16305-04	59	16940-32	210	18000-20	141	18005B27	142	18009Y30	144	18019R20	146
16114-20	29	16305-06	59	16940-36	210	18000B20	141	18005G27	142	18009-36	144	18020-23	146
16114-24	29	16362-02	59	16940-40	210	18000G20	141	18005R27	142	18010-25	144	18020B23	146
16114-28	29	16362-04	59	16941-40	30	18000M20	141	18005Y27	142	18010-30	144	18020R23	146
16114-32	29	16362-06	59	16941-45	30	18000R20	141	18005-32	141	18010Y30	145	18021-18	146
16114-36	29	16363-02	59	16941-50	30	18000W20	141	18005B32	142	18010-36	144	18021B18	146
16114-40	29	16363-04	59	16941-60	30	18000Y20	141	18005G32	142	18011-32	144	18021R18	146
16115-24	29	16363-06	59	16941-61	30	18000-23	141	18005R32	142	18012-32	145	18022-12	146
16115-28	29	16365-02	59	16943-40	30	18000B23	141	18005Y32	142	18012B32	145	18023-11	147
16115-32	29	16365-04	59	16943-45	30	18000G23	141	18006-20	143	18013-30	145	18024-08	147
16115-36	29	16365-06	59	16943-50	30	18000M23	141	18006B20	143	18013W30	145	18024B08	147
16115-40	29	16712-22	30	16943-60	30	18000R23	141	18006G20	143	18013-36	145	18024G08	147
16115-45	29	16712-26	30	16943-61	30	18000Y23	141	18006R20	143	18013G36	145	18024M08	147
16116-28	29	16712-30	30	16944-45	31	18000-26	141	18006Y20	143	18013W36	145	18024R08	147
16116-32	29	16717-20	30	16944-50	31	18000B26	141	18006-25	143	18015-18	145	18024W08	147
16116-36	29	16717-24	30	16944-60	31	18000G26	141	18006B25	143	18015B18	145	18024Y08	147
16116-40	29	16717-28	30	16947-40	30	18000M26	141	18006G25	143	18015R18	145	18024-11	147
16117-20	29	16717-32	30	16947-45	30	18000R26	141	18006R25	143	18015Y18	145	18024B11	147
16117-24	29	16717-36	30	16947-50	30	18000W26	141	18006Y25	143	18015-22	145	18024G11	147
16117-28	29	16717-40	30	16947-60	30	18000Y26	141	18006-30	143	18015B22	145	18024M11	147
16117-32	29	16719-12	30	16947-61	30	18000-30	141	18006B30	143	18015R22	145	18024R11	147

**NUMERICAL INDEX INDICE NUMERICO NUMERISCH INDEX INDEX NUMERIQUE INDICE NUMERICO**

Cod.	pag.	Cod.	pag.	Cod.	pag.	Cod.	pag.	Cod.	pag.	Cod.	pag.	Cod.	pag.
18024W11	147	18109-26	138	18136-EB	447	18166U36	440	18176I30	437	18221R17	150	18275-00	154
18026-07	147	18109-30	138	18136-KA	448	18166-40	437	18176-36	437	18221Y17	150	18276-00	155
18026B07	147	18109-36	138	18136-KE	449	18166A40	440	18176A36	440	18221-19	150	18277-00	117
18026G07	147	18110-26	138	18136-KP	526	18166E40	440	18176E36	440	18221B19	150	18278-00	154
18026M07	147	18110-30	138	18136-KQ	525	18166I40	437	18176I36	437	18221G19	150	18279-14	154
18028-21	148	18110-36	138	18136-KR	526	18166U40	440	18176U36	440	18221M19	150	18280-10	157
18028F21	523	18111-30	138	18136-KU	449	18166-AA	447	18176-40	437	18221R19	150	18280-16	157
18028W21	148	18112-30	138	18152A54	443	18166-AB	447	18176A40	440	18221Y19	150	18280-22	157
18028-25	148	18114-20	138	18152E54	443	18166-AC	447	18176E40	440	18221-21	150	18281-24	157
18028F25	523	18115-20	139	18152U54	443	18166-AD	526	18176I40	437	18221B21	150	18282-18	157
18028M25	148	18115-25	139	18156A33	443	18166-AE	526	18176U40	440	18221G21	150	18282-19	157
18028W25	148	18116-14	139	18156E33	443	18166-AF	526	18176-AE	526	18221M21	150	18282-22	157
18028Y25	148	18116-18	139	18156U33	443	18166-AH	526	18176-AF	526	18221R21	150	18283-27	157
18028-30	148	18122-12	139	18156A40	443	18166-AM	447	18176-AH	526	18221Y21	150	18283-33	157
18028B30	148	18123-11	139	18156E40	443	18166-EB	448	18190-09	159	18222-18	152	18284-21	157
18028F30	523	18124-09	139	18156U40	443	18166-EC	448	18190-AA	526	18224-28	151	18284-27	157
18028W30	148	18125-07	139	18162-54	438	18166-ED	448	18191-22	159	18224B28	151	18284-30	157
18028Y30	148	18125-10	139	18162A54	441	18166-EG	447	18192-09	159	18224R28	151	18284-33	157
18028-36	148	18126-07	139	18162E54	441	18166-EH	447	18199-19	158	18224Y28	151	18301-01	274
18028F36	523	18128-20	139	18162U54	441	18166-EI	447	18201-36	151	18225-28	151	18301-02	274
18028W36	148	18128-24	139	18162A55	439	18166-EJ	448	18203-26	152	18225R28	151	18302-01	274
18029-25	148	18128-30	139	18162E55	439	18166-EL	448	18205-10	151	18226-17	153	18302-02	275
18029W25	148	18132A54	442	18162U55	439	18166-EM	447	18205-12	151	18226B17	153	18323-00	274
18029-30	147	18132E54	442	18162-56	438	18166-KE	449	18206-09	151	18226G17	153	18324-00	274
18029W30	148	18132U54	442	18162A56	441	18166-KP	449	18207-15	151	18226R17	153	18324-10	84
18029-36	147	18132A55	442	18162E56	441	18166-KU	449	18209-06	151	18226W17	153	18324F10	524
18029W36	148	18132E55	442	18162U56	441	18168A24	440	18215-13	152	18226Y17	153	18325-01	200
18030-26	148	18132U55	442	18162A57	439	18168E24	440	18215-21	152	18230-13	139	18325-02	200
18030W26	148	18132-AE	449	18162E57	439	18168U24	440	18217-12	147	18230-17	139	18325-03	200
18030-31	148	18132-AU	449	18162U57	439	18168-GA	449	18220-18	150	18231-13	139	18341-KE	449
18030W31	148	18132-FB	448	18162-AA	447	18172-54	437	18220B18	150	18235-26	153	18341-KU	449
18030-36	148	18132-KA	448	18162-AF	526	18172A54	441	18220R18	151	18235-30	153	18353-17	431
18030W36	148	18132-KE	449	18162-AG	526	18172E54	441	18220Y18	151	18235B30	153	18353-AA	527
18099-15	158	18132-KP	525	18162-KE	449	18172U54	441	18220-20	150	18235G30	153	18353-BB	527
18100-16	138	18132-KQ	525	18162-KU	449	18172A55	439	18220B20	150	18235R30	153	18353-CA	527
18100-20	138	18132-KU	449	18162-RA	438	18172E55	439	18220R20	151	18235W30	153	18353-DB	527
18100-24	138	18136A33	442	18162-RB	438	18172U55	439	18220Y20	151	18235Y30	153	18353-VA	527
18100-30	138	18136E33	442	18166-24	437	18172-56	437	18220-22	150	18236-30	153	18501-01	278
18100-36	138	18136U33	442	18166A24	440	18172A56	441	18220B22	150	18237-26	153	18501-02	278
18102-16	138	18136A34	442	18166E24	440	18172E56	441	18220R22	151	18251-01	153	18501-03	278
18102-20	138	18136E34	442	18166U24	440	18172U56	441	18220Y22	151	18251-02	153	18501-04	278
18102-26	138	18136U34	442	18166-30	437	18172A57	439	18220-26	150	18255-00	158	18501-05	278
18102-30	138	18136A40	442	18166A30	440	18172E57	439	18220B26	150	18261-00	154	18502-18	279
18103-18	138	18136E40	442	18166E30	440	18172U57	439	18220R26	151	18263-00	154	18503-12	279
18104-18	138	18136U40	442	18166I30	437	18172-AF	526	18220Y26	151	18270-22	154	18504-15	279
18106-15	138	18136A41	442	18166-36	437	18172-AG	526	18221-17	150	18271-00	155	18509-01	95
18106-20	138	18136E41	442	18166A36	440	18176-30	437	18221B17	150	18272-00	155	18509-02	95
18106-25	138	18136U41	442	18166E36	440	18176A30	440	18221G17	150	18273-00	155	18509-03	95
18106-30	138	18136-EA	447	18166I36	437	18176E30	440	18221M17	150	18274-00	155	18510-07	95

Cod.	pag.	Cod.	pag.	Cod.	pag.	Cod.	pag.	Cod.	pag.	Cod.	pag.	Cod.	pag.
18510F07	524	18878-00	452	18897M00	454	41200-48	344	41220-07	420	41327-02	337	41442-23	426
18511-15	96	18878M00	452	18897N00	454	41200-49	344	41311-00	363	41327-03	337	41443-AE	527
18511F15	524	18878N00	452	18897R00	454	41200-50	344	41311-AA	527	41327-04	337	41445-01	430
18512-15	96	18878R00	452	19701-00	129	41200-51	344	41311-AB	527	41327-05	337	41445-02	430
18513-14	96	18879-00	453	19702-00	129	41200-52	344	41312-00	363	41327-06	338	41445-22	402
18513F14	524	18879M00	453	19705-00	128	41200-53	344	41313-00	364	41327-07	338	41445-26	402
18514-17	96	18879N00	453	19706-00	128	41200-54	344	41314-00	364	41327-08	338	41445-30	402
18514-18	96	18879R00	453	19709-00	128	41200-55	344	41315-02	364	41327-09	338	41446-18	402
18515-16	96	18880-00	453	19810-00	126	41200-56	344	41315-04	364	41327-10	338	41446-23	402
18516-24	96	18880M00	453	19810-AA	527	41200-57	344	41317-20	364	41380-01	134	41447-02	421
18517-24	96	18880N00	453	19810-AB	527	41200-58	344	41318-00	363	41380-02	134	41447-05	421
18518-22	96	18880R00	453	19901-35	455	41200-59	344	41320-25	338	41390-00	372	41447-38	288
18518-26	96	18882-00	453	19901-40	455	41200-60	344	41320-30	338	41394-02	420	41447-39	528
18518-30	96	18882M00	453	19901-47	455	41200-61	344	41320-35	338	41400-AA	424	41448-06	425
18519-15	96	18882N00	453	19902-38	455	41200-62	344	41321-40	338	41400-AB	527	41448-10	425
18519-22	96	18882R00	453	32931-02	369	41200-63	344	41321-44	338	41402-AA	527	41448-25	425
18519-26	96	18884-00	453	32931-03	370	41200-64	344	41322-19	338	41403-01	427	41448-40	425
18519-30	96	18884M00	453	32931-05	370	41205-01	334	41322-25	338	41403-02	428	41449-27	427
18519-35	96	18884N00	453	32935-03	370	41205-02	334	41322-31	338	41403-03	428	41449-32	427
18520-04	96	18884R00	453	32935-05	370	41205-03	334	41323-01	335	41403-04	428	41450-AA	300
18520-06	96	18886-00	451	32935-10	370	41205-04	334	41323-02	335	41405-AA	424	41451-05	300
18520-08	96	18886M00	451	32935-22	370	41205-05	334	41323-03	335	41405-AB	527	41451-10	300
18520-10	96	18886N00	451	32936-03	370	41205-06	334	41323-04	335	41412-11	422	41452N10	284
18520-12	96	18886R00	451	32936-05	370	41205-07	333	41323-06	335	41414-30	288	41452N16	284
18520-15	279	18887-00	451	41200-01	343	41205-08	333	41323-07	335	41414-31	289	41453-11	317
18874-11	451	18887M00	451	41200-02	343	41205-09	333	41323-08	335	41415-10	422	41453-AA	318
18874M11	451	18887N00	451	41200-03	343	41205-10	334	41323-11	335	41415-11	418	41454-01	317
18874N11	451	18887R00	451	41200-04	343	41206-01	338	41323-12	335	41418-11	418	41454-99	318
18874R11	451	18888-00	455	41200-05	343	41206-02	338	41323-13	335	41418-12	418	41455T55	300
18874-22	451	18888M00	455	41200-06	343	41206-03	287	41323-14	335	41419-12	418	41455-BC	300
18874M22	451	18888N00	455	41200-07	343	41206-04	334	41323-16	335	41425-AA	424	41455-CA	301
18874N22	451	18888R00	455	41200-08	343	41206-05	430	41323-17	335	41427-40	424	41455-CB	301
18874R22	451	18889-00	454	41200-09	343	41207-02	339	41323-18	335	41428-03	422	41456-02	317
18875-00	452	18889M00	454	41200-10	343	41207-03	339	41323-21	335	41429-04	421	41457-00	318
18875M00	452	18889N00	454	41200-11	343	41210-01	40	41323-22	335	41430-11	411	41458-02	300
18875N00	452	18889R00	454	41200-13	343	41210-03	40	41323-23	335	41431-08	291	41458-05	300
18875R00	452	18891-00	454	41200-14	343	41210-05	40	41323-24	335	41431-12	291	41458-10	300
18876-00	451	18891M00	454	41200-15	343	41210-07	40	41323-26	335	41436-11	411	41458-11	301
18876M00	451	18891N00	454	41200-16	343	41210-08	40	41323-27	335	41436-12	411	41458-21	301
18876N00	451	18891R00	454	41200-17	343	41210-10	40	41323-28	335	41437-11	411	41458-23	300
18876R00	451	18893-00	455	41200-18	344	41210-12	40	41323-99	336	41437-12	411	41458-24	301
18876-01	452	18893M00	455	41200-32	344	41210-13	40	41323-AA	527	41438-50	412	41458-25	301
18876M01	452	18893N00	455	41200-33	344	41210-14	40	41325-20	338	41438-60	412	41458-50	301
18876N01	452	18893R00	455	41200-34	344	41220-01	420	41325-30	338	41438-70	412	41458-51	301
18876R01	452	18895-00	454	41200-36	344	41220-02	419	41325-40	338	41439-32	411	41459-10	300
18877-00	452	18895M00	454	41200-40	344	41220-03	419	41326-30	339	41439-38	411	41460-05	300
18877M00	452	18895N00	454	41200-41	344	41220-04	420	41326-36	339	41439-48	411	41460-10	300
18877N00	452	18895R00	454	41200-46	344	41220-05	420	41326-42	339	41442-03	425	41461-07	312
18877R00	452	18897-00	454	41200-47	344	41220-06	419	41327-01	337	41442-14	426	41461B07	312

**NUMERICAL INDEX INDICE NUMERICO NUMERISCH INDEX INDEX NUMERIQUE INDICE NUMERICO**

Cod.	pag.	Cod.	pag.	Cod.	pag.	Cod.	pag.	Cod.	pag.	Cod.	pag.	Cod.	pag.
41461C07	312	41472-23	295	41479-15	313	41491G05	309	41512-50	320	41526-G2	106	41585-37	348
41461G07	312	41472-24	294	41479-AA	313	41491C06	309	41513-13	320	41526-G3	106	41585-45	349
41463A00	305	41472-25	286	41480-03	312	41491G06	309	41513B20	320	41526-R1	106	41585-51	349
41463C00	305	41472-26	294	41480-05	312	41492-00	331	41513C20	320	41526-R2	106	41585-52	349
41463-01	303	41472-27	294	41480B05	312	41492B00	331	41513G20	320	41526-R3	106	41585-53	349
41463-02	304	41472-28	294	41480C05	312	41492C00	331	41514-05	313	41527-10	332	41585-54	349
41463A05	304	41472-29	294	41480G05	312	41492G00	331	41514-10	313	41527G10	333	41586-22	349
41463B05	304	41472-32	287	41480-07	312	41493B00	303	41515-03	318	41527-11	332	41586-28	349
41463G05	304	41472-33	298	41481-02	312	41493C00	303	41515-05	319	41527G11	333	41586-33	349
41463M05	304	41472-34	298	41481-03	312	41493G00	303	41515-07	319	41527-12	332	41586-38	349
41463A30	304	41472-35	298	41483-04	312	41494B00	303	41515-08	318	41527G12	333	41587-25	349
41463C30	304	41472-36	298	41483-06	312	41494C00	303	41515-09	319	41527-13	332	41587-32	349
41463A50	304	41472-37	299	41484-05	311	41494G00	303	41515-10	318	41527G13	333	41589-08	352
41463C50	304	41472-38	299	41484B05	311	41495-08	308	41515-20	319	41528-21	105	41589C08	353
41464-09	312	41472-39	299	41484C05	311	41495-10	308	41515-21	319	41528-22	105	41589-14	352
41464B09	312	41472-40	299	41484G05	311	41496-40	369	41515-22	319	41529-05	356	41589-16	352
41464C09	312	41472-41	299	41486-00	291	41497-05	305	41518-00	366	41530-05	356	41589C16	353
41464G09	312	41472-42	299	41486-01	291	41497B05	305	41518-01	366	41530-07	356	41589-20	353
41465-10	317	41472-43	292	41486-08	291	41497C05	305	41518-02	366	41530-11	356	41589-22	352
41467B08	312	41472-44	292	41486-12	291	41497G05	305	41518B12	320	41538-30	288	41589-25	353
41467C08	312	41472-45	293	41486-15	291	41498B00	303	41518C12	320	41541-44	408	41589-37	353
41467G08	312	41472-46	292	41487-12	291	41498C00	303	41518G12	320	41558-00	367	41589-50	353
41468-20	291	41472-47	299	41487-15	291	41498G00	303	41520-08	106	41559-04	367	41589-58	353
41468-24	291	41472-48	299	41487-17	291	41499-08	369	41520-12	106	41560-28	362	41589-99	353
41469-20	291	41472-50	299	41488-45	292	41500-00	330	41520-16	106	41561-09	356	41589-AA	353
41469-24	291	41473-31	292	41488-47	292	41500-AA	330	41520-24	106	41562-18	366	41589-AB	353
41470A00	306	41473-39	292	41488-50	292	41501-20	367	41522-14	332	41563-07	356	41589-AC	353
41470C00	306	41473-44	292	41488-53	292	41502-20	367	41523-08	332	41563-AA	528	41589-BB	353
41470A03	306	41473-50	292	41489-20	291	41503-00	318	41523G08	333	41564-07	356	41589-CC	353
41470C03	306	41473-56	292	41490-00	307	41503-21	318	41523-09	332	41564-AA	528	41591-32	367
41471-00	291	41473-62	292	41490B00	307	41503-22	318	41523G09	333	41569-33	364	41591-36	367
41471-12	291	41473-66	292	41490C00	307	41504-09	368	41524-04	332	41570-10	111	41591-40	367
41471-15	291	41474-00	292	41490G00	307	41504-10	368	41524-09	332	41570B10	310	41591-45	367
41471-17	291	41474-02	292	41490-01	307	41504-11	368	41524-10	333	41570C10	310	41591-90	366
41472-01	293	41475-00	291	41490B01	307	41504-12	368	41524C10	333	41570G10	310	41592-36	367
41472-04	293	41475-01	291	41490C01	307	41504-19	368	41524-11	333	41582-00	163	41592-45	367
41472-07	293	41475-03	291	41490G01	307	41505-17	368	41524C11	333	41583-00	164	41593-20	366
41472-08	293	41475-04	291	41490-AA	307	41505-19	368	41524-12	333	41585-00	349	41594-12	366
41472-12	287	41475-05	291	41491C00	308	41505-20	367	41524C12	333	41585-01	349	41594-18	366
41472-13	287	41475-20	291	41491G00	308	41507-01	368	41525-00	285	41585-02	349	41595-20	310
41472-14	295	41476-50	292	41491C01	308	41508-10	368	41525-01	285	41585-03	349	41595B44	113
41472-15	295	41477-50	313	41491G01	308	41508C12	368	41526-01	106	41585-10	349	41595B45	113
41472-16	294	41478-35	313	41491C02	308	41510-05	320	41526-02	106	41585-11	348	41597-04	356
41472-17	294	41478-50	313	41491G02	308	41510-08	369	41526-05	106	41585-12	348	41598-00	356
41472-18	294	41479-05	313	41491C03	309	41511-00	369	41526-06	106	41585-13	348	41599-08	356
41472-19	295	41479-11	313	41491G03	309	41511-20	369	41526-B1	106	41585-23	348	41600-00	310
41472-20	294	41479-12	313	41491C04	309	41511-30	369	41526-B2	106	41585-24	348	41600C00	310
41472-21	294	41479-13	313	41491G04	309	41512-15	320	41526-B3	106	41585-25	348	41600G00	310
41472-22	294	41479-14	313	41491C05	309	41512-30	320	41526-G1	106	41585-30	348	41601-17	287

Cod.	pag.	Cod.	pag.	Cod.	pag.	Cod.	pag.	Cod.	pag.	Cod.	pag.	Cod.	pag.
41602-00	287	41615-05	357	41659-06	210	41699-03	330	41735-29	271	41752-12	282	41766-16	272
41603-00	310	41617-05	287	41659-07	210	41699-04	330	41736-32	272	41752-24	282	41766-27	272
41603B00	310	41617-15	287	41659-08	210	41699-06	325	41737-17	272	41753-30	195	41767-20	272
41603C00	310	41618-14	287	41660-10	209	41699-10	329	41737-20	272	41753D30	205	41767G20	273
41603G00	310	41620-04	356	41660-15	209	41699-11	329	41737G20	274	41753-32	195	41767-AA	528
41603-07	310	41628-15	369	41670-06	100	41699-12	330	41737-23	272	41753D32	205	41768-21	272
41603B07	310	41629-17	357	41670-09	100	41699-13	330	41737G23	274	41753-53	195	41768-22	272
41603C07	310	41629-20	357	41670-AA	100	41699-18	330	41738-17	272	41753D53	205	41769-00	273
41603G07	310	41629-25	357	41670-AB	100	41699B18	330	41738-20	272	41753-60	195	41769G00	273
41604-00	311	41635-02	360	41671-11	100	41699C18	330	41738-23	272	41753D60	205	41769-01	273
41604B00	311	41636-25	361	41672-00	100	41699G18	330	41739-20	272	41755-11	282	41769-02	273
41604C00	311	41638-01	361	41673-00	100	41699-20	329	41740-00	273	41756-30	194	41769-36	273
41604G00	311	41638-02	361	41674-00	100	41703-38	33	41743-32	195	41756-32	194	41769-50	273
41604-01	311	41638-04	361	41675-00	100	41704G33	273	41743D32	205	41756-53	194	41770-15	280
41604B01	311	41638-12	361	41676-00	100	41704G36	273	41743-53	195	41756-60	194	41771-96	280
41604C01	311	41638-13	361	41677-00	100	41707-32	33	41743D53	205	41758-53	254	41773-00	103
41604G01	311	41638-91	528	41678-00	100	41707-36	33	41743-60	195	41758-60	254	41774-33	275
41605-00	309	41638-92	528	41678-14	369	41707-40	33	41743D60	205	41758-65	254	41775-34	275
41605-01	309	41638-93	528	41679-23	363	41707-45	33	41744-32	194	41758-85	254	41780-05	268
41605-03	309	41638-94	528	41680-03	321	41707-50	33	41744-53	194	41759-01	252	41780-07	268
41605B03	309	41638-95	528	41680-06	321	41708-32	33	41744-60	194	41759-02	253	41780-09	268
41605C03	309	41639-11	362	41680-12	321	41708-36	33	41745-30	281	41759-03	253	41781-05	271
41605G03	309	41639-17	362	41681-01	322	41708-40	33	41745-35	281	41759-05	253	41781-10	271
41605-25	310	41639-30	362	41681-02	322	41708-45	33	41745-40	281	41759-09	253	41781-15	271
41605B27	309	41639-31	362	41681-03	322	41708-50	33	41745-50	281	41760-02	253	41782-04	324
41605G27	309	41639-32	362	41681-04	322	41717-60	33	41745-60	281	41760-05	253	41782-05	324
41606-00	317	41639-40	362	41681-06	321	41717-80	33	41745-65	281	41760-06	253	41782-06	324
41606-01	317	41639-41	362	41681-10	321	41719-32	33	41746-60	194	41760-08	253	41800-05	431
41606-02	317	41639-42	362	41681-11	321	41719-36	33	41747-60	195	41760-09	253	41800-10	431
41606-22	317	41645-00	285	41681-12	321	41719-40	33	41748-20	195	41760-20	252	41801-05	431
41607-00	285	41646-06	354	41681-99	322	41720-18	29	41748-30	195	41760-21	252	41806-00	430
41608-00	328	41646-10	354	41683-26	104	41720-20	29	41748-35	195	41760-22	252	41806-03	430
41608-03	328	41646-15	354	41686-12	366	41720-24	29	41748-40	195	41760-26	252	41807-12	431
41608-04	325	41646-20	354	41687-06	366	41720-28	29	41748-50	195	41760-27	252	41808-04	431
41608-08	328	41650-06	354	41687-12	366	41720-30	29	41750-20	195	41761-02	273	41809-09	448
41608-20	328	41650-10	354	41690A11	443	41720-32	29	41750-30	195	41762-07	279	41810-04	430
41609-36	311	41650-13	354	41690E11	443	41727-28	280	41750-40	195	41762-09	279	41810-09	430
41609B36	311	41651-20	412	41690U11	443	41727-30	280	41750-41	195	41762-13	279	41820-03	366
41609C36	311	41651-25	412	41691A11	443	41727-33	280	41750-50	195	41763-00	279	41860-36	474
41609G36	311	41651-30	412	41691E11	443	41727-36	280	41751-30	194	41763-30	468	41860-43	474
41609-75	311	41651-35	412	41691U11	443	41727-40	280	41751F30	524	41764-28	272	41860-47	474
41611-20	317	41651-40	412	41695-10	449	41727-45	280	41751-35	194	41764-33	272	41861-44	475
41614-22	286	41651-45	412	41695-15	449	41727-50	280	41751-40	194	41764-40	272	41862B11	475
41614-33	286	41651-50	412	41695-50	449	41727-55	280	41751F40	524	41765-32	271	41862C11	475
41614-34	286	41651-55	412	41695-90	449	41727-60	280	41751-50	194	41765-37	271	41862G11	475
41614-35	286	41651-60	412	41697-00	102	41729-30	212	41751-60	194	41765-41	271	41862B53	475
41614-36	286	41651-65	412	41698-22	102	41729-34	212	41751F60	524	41765-45	271	41862C53	475
41615-01	357	41654-80	412	41698-30	102	41734-60	280	41751-65	194	41765-50	271	41862G53	475
41615-03	357	41654-99	412	41698-40	102	41735-20	272	41752-08	282	41766-14	272	41870-01	406

**NUMERICAL INDEX INDICE NUMERICO NUMERISCH INDEX INDEX NUMERIQUE INDICE NUMERICO**

Cod.	pag.	Cod.	pag.	Cod.	pag.	Cod.	pag.	Cod.	pag.	Cod.	pag.	Cod.	pag.
41870-02	406	41908-00	428	41961-10	109	42452-53	418	42501-15	162	42521-16	165	42537-80	165
41870-03	406	41908-01	428	41961-12	109	42453-23	424	42501-20	162	42521-24	165	42538-00	165
41870-04	406	41909-08	430	41961-15	109	42460-00	423	42502-11	162	42522-00	165	42538-01	165
41875-40	410	41910-AL	528	41962-10	109	42460-06	423	42503-10	162	42522-01	165	42538-02	165
41875-61	410	41911-02	428	41962-12	109	42460-26	425	42504-09	103	42522-02	165	42538-03	165
41876-30	410	41911-03	429	41962-15	109	42460-27	425	42505-21	162	42522-03	165	42538-04	165
41876-38	410	41911-04	429	41964-45	25	42460-43	430	42505-24	162	42522-04	165	42538-05	165
41876-45	410	41911-AA	529	41964-60	25	42460-45	431	42505-27	162	42522-05	165	42538-07	165
41876-58	410	41911-AE	529	41980-99	103	42460-53	429	42505-50	162	42522-07	165	42538-09	165
41877-45	409	41912-03	427	42400-19	432	42460-63	423	42506-08	162	42522-09	165	42538F09	524
41877-61	409	41912-04	427	42400-25	432	42460-64	424	42506-10	162	42522F09	524	42539-00	165
41877-81	409	41913-03	427	42400-30	432	42460-74	432	42506-12	162	42523-00	160	42539-01	165
41877-99	409	41913-04	427	42401-10	354	42460-76	432	42506-14	162	42524-06	162	42539-02	165
41878-45	409	41914-03	25	42401-15	354	42461-11	418	42506-16	162	42524-08	162	42539-03	165
41878-61	409	41916-10	110	42401-20	354	42461-35	418	42506-18	162	42524-10	162	42539-04	165
41878-81	409	41916-15	110	42401-AA	529	42462-11	415	42507-12	161	42524-12	162	42539-05	165
41878-99	409	41916-20	110	42403-01	354	42462-12	415	42508-00	163	42524-14	162	42539-07	165
41879-30	410	41919-03	405	42403B01	354	42462-13	415	42508-01	163	42524-16	162	42539-09	165
41879-40	410	41920-03	432	42405-10	354	42462-14	415	42509-25	103	42524-18	162	42539F09	524
41879-50	410	41920-05	432	42405-20	354	42462-16	415	42509-50	103	42524-20	162	42540-40	166
41879-61	410	41922-16	110	42405-AA	529	42462-23	415	42509-60	104	42524-22	162	42540-50	166
41880-38	410	41922-22	110	42406-35	432	42463A00	429	42509-99	104	42524-30	162	42540-80	166
41880-61	410	41925-14	111	42406-40	432	42463B00	429	42510-00	162	42525-27	162	42541-06	166
41881-30	410	41925-16	111	42407-03	354	42463A02	413	42511-20	161	42526-12	162	42542-00	167
41881-40	410	41925-18	111	42407-06	354	42463B02	413	42511-25	161	42526-14	162	42543-00	166
41882-15	410	41925-20	111	42413-24	365	42463A04	413	42511-30	161	42529-06	161	42543-01	166
41882-20	410	41925-22	111	42414-05	365	42463B04	413	42511-35	161	42530-26	163	42543-02	166
41882-25	410	41925-24	111	42414-10	365	42463A05	413	42511-40	161	42530-32	163	42543-03	166
41882-30	410	41925-26	111	42414-15	365	42463B05	414	42511-56	161	42530-41	163	42543-04	166
41885-30	409	41929-00	101	42414-20	365	42463A08	413	42511-60	161	42530-50	163	42543-05	166
41885-40	409	41929-02	101	42417-22	365	42463B08	414	42511-70	161	42531-26	163	42544-00	166
41885-45	409	41930-39	25	42420-06	363	42463-11	415	42512-35	104	42531-32	163	42544-01	166
41885-50	409	41931-08	112	42420-08	363	42463-12	415	42512-90	475	42531-41	163	42544-02	166
41885-60	409	41931-14	112	42440-30	410	42463-13	415	42512-91	475	42531-50	163	42544-03	166
41900-04	432	41931-16	112	42441-25	410	42463-14	415	42512-92	475	42532-29	163	42544-04	166
41900-10	432	41931-18	112	42442-24	410	42463-16	415	42512-93	475	42532-58	163	42544-05	166
41901-08	431	41932-05	112	42443-06	370	42463-23	415	42513-30	104	42533-23	204	42546-00	165
41901-16	431	41933-18	112	42443-08	370	42470-00	423	42513-45	104	42533-26	204	42546-01	165
41903A10	443	41940-06	422	42445-03	371	42470-06	423	42514-20	161	42533-31	204	42546-02	165
41903E10	443	41940B06	422	42445-04	371	42470-07	423	42515-18	161	42533-36	204	42546-03	165
41903U10	443	41941-43	423	42445-05	371	42470-26	425	42515-20	161	42533-40	204	42546-04	165
41904-10	432	41941-44	422	42446-04	371	42470-27	425	42516-18	161	42534-26	163	42546-05	165
41905-03	421	41944-06	421	42450-00	423	42470-43	430	42516-20	161	42534-32	163	42555-11	268
41905-38	421	41944B06	421	42450-AD	423	42470-45	431	42517-06	161	42534-41	163	42556-00	123
41906-60	422	41945-38	422	42451-11	423	42470-53	429	42518-01	165	42535-24	166	42558-00	124
41907-02	432	41960-08	109	42451-12	423	42470-63	423	42518-50	166	42535-32	166	42560-01	122
41907-04	432	41960-10	109	42452-14	424	42470-64	424	42519-01	167	42535-49	166	42560-02	122
41907-06	432	41960-12	109	42452-23	424	42470-74	432	42520-00	167	42537-40	165	42560-03	122
41907-56	422	41960-15	109	42452-35	418	42470-76	432	42520-AA	529	42537-50	165	42560-04	123

Cod.	pag.	Cod.	pag.	Cod.	pag.	Cod.	pag.	Cod.	pag.	Cod.	pag.	Cod.	pag.
42560-05	123	42577-94	530	42616-04	105	42666S22	378	42683P18	380	42727-18	383	42798S11	383
42560-06	123	42577-99	530	42617-04	356	42666P27	378	42683S18	380	42727-22	383	42800P20	387
42560-07	123	42579-00	163	42617-05	356	42666S27	378	42684P08	382	42727-30	383	42800S20	387
42560-08	123	42581-01	105	42617-06	356	42666P30	378	42684S08	382	42727-38	383	42801P14	387
42560-09	123	42581-03	105	42617-07	356	42666S30	378	42685P14	381	42728-09	383	42801S14	387
42562-12	104	42581-05	105	42620P01	382	42666P40	378	42685S14	381	42728-12	383	42822-00	274
42562-14	104	42581-10	105	42620P02	382	42666S40	378	42685-22	386	42728-18	383	42826-32	274
42562-16	104	42581-15	105	42620P03	382	42667P12	379	42686P21	377	42728S18	383	42826-37	274
42562-18	104	42581-20	105	42620P04	382	42667S12	379	42686S21	377	42728-22	383	42830-08	96
42562-20	104	42584-01	361	42623-10	100	42667P18	379	42687P18	377	42728-30	383	42854B25	102
42562-25	104	42584-02	361	42624P10	379	42667S18	379	42687S18	377	42728-38	383	42854C25	102
42562-30	104	42584-04	361	42624S10	379	42667P22	379	42687P22	377	42741-22	380	42854G25	103
42563-00	118	42584-05	361	42650-10	116	42667S22	379	42687S22	377	42742-22	380	42854K25	103
42563-44	119	42584-06	362	42650-11	116	42667P30	379	42687P30	377	42746P12	378	42854R25	103
42565-00	118	42584-07	362	42653-04	112	42667S30	379	42687S30	377	42746P18	378	42854Y25	103
42566-03	117	42585-00	462	42660-02	387	42668P12	378	42688P18	377	42746S18	378	42854B30	102
42569-04	123	42585-04	462	42661-02	382	42668S12	378	42688S18	377	42746P22	378	42854C30	102
42570-32	125	42585-06	462	42661-03	382	42668P18	378	42688P22	377	42746S22	378	42854G30	103
42570-91	529	42586-09	462	42661-06	382	42668S18	378	42688S22	377	42746P30	378	42854K30	103
42570-92	529	42586-10	462	42662C14	384	42668P22	378	42688P30	377	42746S30	378	42854R30	103
42570-94	529	42587-04	462	42662P14	384	42668S22	378	42688S30	377	42746P40	378	42854Y30	103
42570-99	529	42588-00	116	42662S14	384	42668P30	378	42692B14	387	42746P50	378	42862-00	102
42571-20	125	42588-01	116	42663C14	385	42668S30	378	42693B14	387	42746P80	378	42863-00	102
42572-24	125	42589-00	117	42663P14	385	42668P40	378	42701-10	379	42747P12	378	42864-10	164
42573-31	125	42590-02	107	42663S14	385	42669C14	385	42701P10	379	42747S12	378	42870-50	414
42573-91	529	42590R02	107	42664P12	379	42669P14	385	42702-10	380	42747P18	378	42870-51	414
42573-92	529	42590-03	107	42664S12	379	42669S14	385	42702P10	380	42747S18	378	42870-59	419
42573-94	529	42590R03	107	42664P18	379	42670B14	384	42703-10	379	42749P18	377	42872-02	419
42573-99	529	42592-01	102	42664S18	379	42670N14	384	42703S10	379	42749S18	377	42873-01	359
42574-37	125	42592-02	102	42664P22	379	42670W14	384	42704-10	380	42749P22	377	42873-02	420
42574-90	529	42593-00	363	42664S22	379	42674P18	379	42704S10	380	42749S22	377	42873-65	415
42574-91	529	42595-01	116	42664P30	379	42674S18	379	42705P10	377	42764M15	385	42874-01	414
42574-92	529	42596-02	116	42664S30	379	42674P22	379	42705S10	377	42764P16	383	42874-02	414
42574-93	529	42597-00	115	42664P40	379	42674S22	379	42705M15	385	42764S16	383	42874-03	414
42574-94	529	42598-00	117	42665P12	378	42674P30	379	42705P16	383	42764P21	383	42874-04	414
42574-99	529	42599-06	118	42665S12	378	42674S30	379	42705S16	383	42764S21	383	42875-17	358
42575-37	125	42599-08	118	42665P18	378	42676P15	381	42705P21	383	42767P12	381	42875B17	358
42575-90	529	42607-05	203	42665S18	378	42676S15	381	42705S21	383	42767S12	381	42875-20	358
42575-91	529	42609-10	107	42665P22	378	42676P20	381	42707P21	380	42767P15	381	42875B20	358
42575-92	529	42609-15	107	42665S22	378	42676S20	381	42707S21	380	42767S15	381	42876-20	359
42575-93	529	42609-20	107	42665P30	378	42677P14	381	42710-11	381	42767P20	381	42876B20	359
42575-94	529	42609-23	107	42665S30	378	42677S14	381	42720-00	385	42767S20	381	42876-25	359
42575-99	529	42609-25	107	42665P40	378	42678P14	384	42720-01	386	42785S20	387	42876B25	359
42576-00	124	42614-04	255	42665S40	378	42678S14	384	42723P10	386	42786S20	387	42877-17	358
42577-39	124	42614-05	255	42666P12	378	42678W14	384	42723S10	386	42796P16	383	42877-25	358
42577-90	530	42614-06	255	42666S12	378	42680-13	386	42725P10	386	42796S16	383	42878-17	358
42577-91	530	42614-07	255	42666P18	378	42681-16	387	42725S10	386	42796P23	383	42878-25	358
42577-92	530	42614-21	203	42666S18	378	42682P18	380	42727-09	383	42796S23	383	42879K12	358
42577-93	530	42615-04	105	42666P22	378	42682S18	380	42727-12	383	42798P11	383	42879M12	357



**NUMERICAL INDEX INDICE NUMERICO NUMERISCH INDEX INDEX NUMERIQUE INDICE NUMERICO**

Cod.	pag.	Cod.	pag.	Cod.	pag.	Cod.	pag.	Cod.	pag.	Cod.	pag.	Cod.	pag.
42879K15	358	42935-19	358	42956-28	357	42972-04	417	44030-03	476	44060-50	103	44103-04	324
42879M15	357	42935-26	358	42959-12	365	42972-28	416	44031-01	477	44060-51	326	44103-06	324
42879K22	358	42936-23	417	42959-13	365	42973-30	416	44031-02	477	44060-80	103	44103-AA	531
42879M22	357	42936-24	417	42962-04	426	42973-45	416	44031-04	463	44060-99	326	44103-AB	531
42879K25	358	42936-28	417	42962-26	426	42973-60	416	44031-05	463	44061-08	103	44103-AC	531
42879M25	357	42939-15	370	42962C26	426	42973-61	416	44033-23	467	44061-09	103	44104-01	286
42900-15	101	42939-AA	530	42962-30	426	42974B13	358	44033-38	467	44061-12	103	44104-02	286
42900-24	101	42940-03	407	42962-44	426	42974C13	358	44034-11	467	44061-14	103	44104-15	286
42901-20	101	42941-22	371	42962C44	426	42974M13	358	44040-40	464	44077-00	484	44105-00	318
42901-25	101	42941-AA	530	42963-55	415	42974N13	358	44041-00	464	44077-06	484	44106B05	323
42901-30	101	42942-16	369	42964-53	167	42979-00	407	44041-01	464	44077-10	484	44106G05	322
42901-35	101	42944-23	358	42964-60	167	42979-36	407	44041-03	464	44077-CC	484	44106O05	323
42901-40	101	42945-18	358	42965-12	417	42979-45	407	44041-04	464	44089-12	486	44106R05	323
42902-30	102	42945-23	358	42967-03	416	42980-01	408	44041-05	464	44093-00	411	44106W05	322
42902B30	309	42945-27	358	42967-04	416	42980-02	408	44042-00	464	44093-01	411	44106Y05	322
42902C30	309	42946-23	417	42967-05	416	42981-73	407	44043-00	464	44094-00	457	44106B10	323
42902G30	309	42946-37	417	42967-06	416	42982-08	407	44044-00	464	44094R00	457	44106G10	322
42902-31	102	42947-23	417	42967-07	416	42988-99	397	44047-17	463	44094-01	457	44106O10	323
42903-29	103	42947-30	417	42967-08	416	42988C99	397	44047-19	463	44094-02	457	44106R10	323
42904-01	102	42947-40	417	42967-11	418	42988G99	397	44047-22	463	44094-03	458	44106W10	322
42904-02	102	42948-18	358	42967-13	416	42990-16	419	44047-25	463	44094-04	458	44106Y10	322
42904-03	102	42948-20	358	42967-14	416	42990M16	419	44047-28	463	44094-05	458	44106-12	324
42907-01	101	42948-23	358	42967-15	416	42990N16	419	44048-99	330	44094-06	458	44106B20	323
42907-02	101	42948-25	358	42967-16	416	42990-20	419	44055-10	327	44094-RE	530	44106G20	322
42907-03	101	42949-26	420	42967-17	416	42990M20	419	44055-20	327	44095-12	486	44106O20	323
42907-04	101	42950-01	347	42967-18	416	42990N20	419	44055-25	327	44095-18	486	44106R20	323
42907-06	101	42950-02	347	42967-35	416	42990-29	419	44055-30	327	44095-30	477	44106W20	322
42907-07	101	42950-03	347	42967-43	417	42990M29	419	44055C30	327	44095-32	477	44106Y20	322
42907-08	101	42950-04	347	42967-53	417	42990N29	419	44055G30	327	44096-01	481	44106B25	323
42907-09	101	42950-05	347	42967-63	415	42991-25	418	44055-35	327	44096-02	481	44106G25	322
42907-10	101	42950-06	347	42967-64	415	42991M25	418	44055-40	327	44096-03	481	44106O25	323
42907-30	101	42950-07	347	42967-65	415	42991N25	418	44055C40	327	44096-80	486	44106R25	323
42907-35	101	42950-08	347	42967-66	415	42991-32	418	44055G40	327	44096B80	486	44106W25	322
42907-40	101	42950-09	347	42967-67	415	42991M32	418	44055-50	327	44096G80	486	44106Y25	322
42908-24	112	42950-92	347	42967-68	415	42991N32	418	44056-01	327	44096R80	486	44107B05	323
42920-02	285	42950-93	347	42967-73	415	42993-40	419	44056-04	326	44096Y80	486	44107G05	323
42921-00	361	42950-94	347	42967-74	415	42993M40	419	44056-06	326	44097-00	485	44107O05	323
42923-07	285	42951-08	371	42967-75	415	42993N40	419	44056-11	327	44098-03	486	44107R05	323
42924-02	359	42951-57	371	42967-76	415	44009-00	463	44056-21	327	44098-08	486	44107W05	323
42926-12	360	42951-59	372	42967-77	415	44020-21	463	44057-04	326	44098-12	486	44107Y05	323
42927-02	360	42952-05	371	42967-78	415	44023-00	462	44057-06	326	44098-24	486	44107B10	323
42928-00	360	42953-04	362	42968-38	416	44023-AA	530	44058-10	325	44099-03	324	44107G10	323
42929-01	360	42954-04	371	42968-42	417	44024-00	462	44058-20	327	44100-01	324	44107O10	323
42929-02	360	42954-18	371	42969-11	417	44025-50	463	44058-25	327	44100-02	324	44107R10	323
42929-03	360	42954-29	371	42969-31	417	44026-60	478	44058-30	327	44100-04	324	44107W10	323
42929-AA	530	42954-46	371	42969-36	417	44027-00	463	44058-40	327	44101-03	324	44107Y10	323
42929-AB	530	42955-00	362	42972-01	417	44027-AA	530	44058-50	327	44101-AA	531	44107B20	323
42929-AC	530	42956-19	357	42972-02	417	44028-19	466	44060-01	326	44102-24	320	44107G20	323
42931-19	359	42956-24	357	42972-03	417	44029-00	463	44060-02	326	44103-03	324	44107O20	323

Cod.	pag.	Cod.	pag.	Cod.	pag.	Cod.	pag.	Cod.	pag.	Cod.	pag.	Cod.	pag.
44107R20	323	44150-19	482	44183-01	495	44205-28	43	44233-20	46	44262-42	340	44337B06	75
44107W20	323	44151-00	482	44183-A3	495	44207-16	44	44234-12	46	44263-36	340	44338-03	75
44107Y20	323	44151-AA	482	44183-A4	495	44207-20	44	44234S12	47	44264-35	340	44338-06	75
44107B25	323	44151-AB	482	44184-01	495	44207-24	44	44234-16	46	44265-35	340	44339-03	75
44107G25	323	44151-AC	482	44184-A3	495	44207-28	44	44234S16	47	44312A06	77	44339-06	75
44107O25	323	44160-03	482	44184-A4	495	44208G00	44	44235-16	47	44312B06	77	44342-06	77
44107R25	323	44160-AA	531	44201-01	42	44208R00	44	44236S28	47	44312G06	77	44343-06	77
44107W25	323	44161-00	483	44201-03	42	44209R26	44	44236S34	47	44312O06	77	44344-06	77
44107Y25	323	44164-00	483	44201-10	42	44209R32	44	44237S15	47	44312R06	77	44345-06	77
44108-01	320	44165-35	484	44201B10	42	44210-26	44	44238-15	47	44312Y06	77	44346-06	77
44108-02	320	44165-40	484	44201N10	42	44210S26	44	44239R16	43	44313B06	77	44347-06	77
44110-00	328	44165-50	484	44201O10	42	44210-32	44	44240-08	47	44313G06	77	44352-30	447
44110-01	327	44166-28	483	44201R10	42	44210S32	44	44240S08	42	44313O06	77	44352-40	447
44110-02	327	44167-13	483	44201V10	42	44210-42	44	44241-19	47	44313R06	77	44355-30	447
44110-03	327	44168-12	485	44201B12	42	44210S42	44	44242-00	47	44313Y06	77	44355-40	447
44110-04	327	44169B06	485	44201N12	42	44212-30	45	44243-00	47	44314A06	77	44357-10	357
44110-05	327	44169R06	485	44201O12	42	44213-24	45	44244S30	48	44314B06	77	44357B10	357
44110-06	327	44169B14	485	44201R12	42	44213-36	45	44244S36	48	44314G06	77	44357-15	357
44111-02	327	44169R25	485	44201V12	42	44214-25	45	44245S32	47	44314O06	77	44357B15	357
44112-01	328	44170-00	483	44201N16	42	44215S16	45	44246S11	48	44314R06	77	44366-10	372
44112-02	328	44170-01	483	44201R16	42	44216S16	44	44246S14	48	44314Y06	77	44371-24	50
44114-01	328	44171-24	484	44201N20	42	44217-45	45	44246S17	48	44315A06	77	44371-28	50
44114-02	328	44171-50	484	44201R20	42	44218R30	44	44247S16	48	44315B06	77	44371-32	50
44114-03	328	44172-30	485	44201N24	42	44218R40	44	44247-38	43	44315G06	77	44371-36	50
44118-10	328	44173-00	484	44201R24	42	44219R26	44	44248S60	339	44315O06	77	44371-40	50
44118-20	328	44174-24	481	44201N28	42	44220S24	45	44249S30	339	44315R06	77	44371-44	50
44118-25	328	44174-AA	531	44201R28	42	44220S32	48	44249S35	339	44315Y06	77	44371-48	50
44118-30	328	44175-15	482	44201N32	42	44220S38	48	44250S30	339	44317A06	77	44372-26	50
44118-35	328	44176-30	482	44201R32	42	44220-AA	531	44250S35	339	44317B06	77	44372-32	50
44118-40	328	44177-12	482	44202-10	42	44221S30	45	44251-01	365	44317G06	77	44372-36	50
44118-50	328	44178-01	480	44202B12	42	44222-20	45	44251-03	365	44317O06	77	44372-40	50
44119-01	328	44178-02	480	44202N12	42	44222S20	45	44254-30	339	44317R06	77	44374-22	50
44119-02	328	44178-15	480	44202O12	42	44222-28	45	44255-08	48	44317Y06	77	44374-25	50
44119-03	328	44178-16	480	44202R12	42	44222S28	45	44255-10	47	44322-02	60	44374-32	50
44119-04	328	44178-17	481	44202V12	42	44223S19	47	44255-12	48	44322-04	60	44374-36	50
44119-06	328	44178-18	481	44202N25	43	44224-22	45	44255-14	48	44322-06	60	44374-40	50
44130-01	326	44178-19	481	44202R25	42	44224S22	46	44255-15	48	44332-03	74	44374-44	50
44130-02	326	44178-20	481	44202N27	43	44225-22	46	44255-16	48	44332-06	74	44375-25	50
44130-03	326	44178-66	488	44202R27	42	44226S30	46	44255-21	48	44332B06	74	44376-40	50
44135-02	326	44178-67	488	44202N29	43	44227-30	46	44255-22	48	44333-03	75	44379-05	357
44141-01	483	44178-69	488	44202R29	42	44228S23	46	44256-01	340	44333-06	75	44382A06	74
44141-03	483	44180-01	496	44203R20	42	44229S20	46	44256-02	340	44333B06	75	44382B06	74
44142-40	483	44180-02	496	44203R24	42	44230S10	46	44256-03	340	44334-03	75	44382G06	74
44147-00	484	44181-01	496	44203R28	42	44230S14	46	44256-04	340	44334-06	75	44382O06	74
44147-01	484	44181-02	496	44204R24	43	44231-14	46	44258-60	339	44335-03	75	44382Y06	74
44147-02	484	44182-01	496	44204R28	43	44232S12	46	44259-29	340	44335-06	75	44383O06	75
44147-03	484	44182-02	496	44205-16	43	44232S16	46	44260-30	275	44335B06	75	44383Y06	75
44148-01	483	44182-03	496	44205-20	43	44232S20	46	44260-34	275	44337-03	75	44384A06	75
44149-03	482	44182-04	496	44205-24	43	44233-16	46	44261-46	340	44337-06	75	44384O06	75

**NUMERICAL INDEX INDICE NUMERICO NUMERISCH INDEX INDEX NUMERIQUE INDICE NUMERICO**

Cod.	pag.	Cod.	pag.	Cod.	pag.	Cod.	pag.	Cod.	pag.	Cod.	pag.	Cod.	pag.
44384R06	75	44450-13	258	44470-40	400	44477-55	401	44480-10	350	44513-90	468	44820-99	476
44384Y06	75	44450B13	258	44470-73	400	44477-64	401	44480-11	350	44521E10	468	44822-80	476
44385A06	75	44450-15	258	44470-74	400	44477-65	401	44480-12	350	44521-16	468	44822-99	476
44385B06	75	44450B15	258	44470-75	400	44477-66	401	44480-13	350	44521-21	468	44825-20	477
44385G06	75	44450-17	258	44471-11	337	44477-67	401	44480-14	350	44521-31	468	44825-40	477
44385O06	75	44450B17	258	44471-12	337	44477-68	401	44480-15	351	44522E10	468	44826-00	476
44385R06	75	44450-21	258	44471-13	337	44477-69	401	44480-16	351	44522-16	468	44826-20	477
44385Y06	75	44450B21	258	44471-14	337	44477-76	402	44480-17	351	44522-21	468	44830-52	473
44387A06	75	44450-23	258	44471-24	337	44477-77	402	44480-18	351	44522-31	468	44830-72	473
44387B06	75	44450B23	258	44473-02	275	44477-78	402	44480-19	351	44620-01	465	44830-99	473
44387G06	75	44451-22	258	44473-03	275	44477-79	402	44480-20	351	44620-02	465	44831-52	473
44387O06	75	44451B22	258	44473-05	336	44477-80	402	44501-01	26	44620-03	465	44832-99	473
44387R06	75	44452-31	257	44473-07	337	44477-81	402	44501-02	26	44620-04	465	44833-99	473
44387Y06	75	44452B31	257	44473-08	337	44478-20	351	44501-03	26	44620-05	465	44834-00	398
44389-32	50	44453-14	257	44473-31	336	44478-21	351	44501-04	26	44620-06	465	44834G00	398
44390-07	50	44453B14	257	44473-32	336	44478-22	351	44502-01	26	44620-07	465	44834-01	398
44390-09	50	44454-11	257	44473-33	336	44478-23	351	44502-02	26	44620-14	465	44834G01	398
44390-11	50	44454B11	257	44473-34	336	44478-24	351	44502-03	26	44620-17	465	44834-02	398
44390-15	50	44455-09	257	44475-76	289	44478-25	351	44502-04	26	44625-03	465	44834G02	398
44390-18	50	44455B09	257	44475-77	289	44478-26	351	44503-01	26	44625-04	465	44834-03	398
44390-23	50	44456-14	257	44475-78	289	44478-27	351	44503-02	26	44625-05	465	44834G03	398
44391-12	50	44456B14	257	44475-79	289	44478-28	351	44503-03	26	44625-06	465	44835-36	398
44394-18	50	44457-32	257	44475-80	289	44478-29	351	44503-04	26	44625-07	465	44835G36	398
44394-21	50	44457B32	257	44475-81	289	44478-30	351	44505-10	472	44625-08	465	44835-45	398
44395-18	50	44459-28	258	44475-82	289	44478-31	351	44505-15	472	44625-26	465	44835G45	398
44397-18	50	44459B28	258	44475-83	289	44478-32	351	44505-20	472	44625-34	465	44835-53	398
44412-00	60	44461-20	258	44476-20	405	44478-33	351	44505-25	472	44630-01	133	44835G53	398
44421-00	60	44461B20	258	44476-26	405	44478-34	351	44506-09	472	44630-02	134	44836-30	398
44422-00	60	44462-25	258	44476-27	405	44478-35	351	44511E21	467	44630-03	134	44836G30	398
44423-00	60	44462B25	258	44476-28	405	44478-70	403	44511-27	468	44630-04	134	44837-05	424
44430-60	194	44463-11	257	44476-29	405	44478-71	403	44511-34	468	44630-05	134	44837B05	424
44430-61	194	44464-23	257	44476-30	405	44478-72	403	44511-38	468	44630-06	134	44837-20	424
44431-46	194	44465-24	257	44476-31	405	44478-73	404	44511-42	468	44630-07	134	44837B20	424
44431-60	194	44466-07	296	44476-32	405	44478-74	404	44511-63	468	44801-09	476	44837C20	424
44432-21	60	44466-11	396	44476-33	405	44478-75	404	44511E63	467	44801-18	477	44837-25	424
44446-10	399	44466-12	396	44476-51	405	44478-76	404	44511-90	468	44803-10	475	44837B25	424
44446B10	399	44466-13	396	44476-52	405	44478-77	403	44511E90	467	44803-20	475	44840-01	394
44446-14	399	44466-14	396	44476-53	405	44478-78	403	44512E12	467	44803-30	475	44840-02	394
44446B14	399	44466-15	396	44477-24	401	44478-79	403	44512E21	467	44807-18	476	44840-03	394
44446-18	399	44466-16	396	44477-25	401	44478-80	403	44512-34	468	44807-28	475	44840-04	394
44446B18	399	44466-30	296	44477-26	401	44480-00	350	44512-42	468	44807-36	475	44840-05	394
44449-30	399	44470-03	400	44477-27	401	44480-01	350	44512-63	468	44818-11	73	44840-06	425
44449B30	399	44470-04	400	44477-28	401	44480-03	350	44512-90	468	44818-12	73	44840-07	425
44449-32	399	44470-11	400	44477-40	401	44480-04	350	44513E12	467	44818-13	73	44840-08	405
44449B32	399	44470-12	400	44477-41	401	44480-05	350	44513E21	467	44818-14	73	44840-10	405
44450-11	258	44470-13	400	44477-44	401	44480-06	350	44513-34	468	44818-16	73	44840-18	405
44450B11	258	44470-14	400	44477-52	401	44480-07	350	44513-38	468	44819-02	476	44840-27	353
44450-12	258	44470-24	400	44477-53	401	44480-08	350	44513-54	468	44819-03	476	44840-28	353
44450B12	258	44470-30	400	44477-54	401	44480-09	350	44513-63	468	44820-80	476	44840-30	404

Cod.	pag.	Cod.	pag.	Cod.	pag.	Cod.	pag.	Cod.	pag.	Cod.	pag.	Cod.	pag.
44840-31	404	44847-09	395	44877B12	73	44940-10	314	44960-02	277	44982-10	255	47020-35	191
44840-32	404	44847B09	394	44877-13	73	44940-11	314	44960-03	277	44986-12	469	47021-30	191
44840-40	404	44847-13	395	44877B13	73	44940-12	314	44960-04	277	44986-17	469	47021-35	191
44840-41	404	44847B13	394	44877-14	73	44940-13	314	44960-06	277	44986-21	469	47021-45	191
44840-42	404	44847-20	395	44877B14	73	44940-14	314	44960-07	277	44986-28	469	47022-12	203
44840-50	403	44847B20	394	44877-16	73	44940-16	314	44960-10	277	44987-11	470	47023-01	285
44840-51	403	44849-27	397	44877B16	73	44940-17	314	44960K10	278	44987C11	470	47023-02	285
44840-52	403	44849-34	397	44877-24	72	44940-18	315	44960-11	277	44987-60	470	47023-03	285
44840-55	403	44849-47	397	44877B24	72	44940-19	315	44960K11	278	44987C60	470	47023-04	285
44840-56	403	44850-00	397	44878-11	72	44940-24	315	44960-13	277	44987C62	469	47024-06	200
44840-57	403	44850B00	397	44878B11	72	44940-25	315	44961-02	470	44990-15	315	47024-10	200
44841-18	395	44850W00	397	44878-12	73	44940-26	315	44961-03	276	44990-24	315	47025-06	200
44841-21	395	44850-11	397	44878B12	73	44940-32	315	44961M03	276	44990-29	315	47025-10	200
44841-26	395	44850B11	397	44878-13	73	44940-33	315	44961-04	469	44990-36	315	47026-06	200
44841-37	395	44850-12	397	44878B13	73	44940-34	315	44961-05	469	44990-48	315	47027-11	201
44841-51	395	44850B12	397	44878-14	73	44941B05	305	44961-06	469	44992-02	355	47027-12	201
44841B51	395	44850G12	397	44878B14	73	44941C05	305	44962-01	277	44992-03	354	47027-13	201
44842-30	396	44850-13	260	44878-16	73	44941G05	305	44962-05	278	44993-01	355	47027-14	201
44842-31	396	44850B13	260	44878B16	73	44942-01	316	44968-00	470	44994-00	355	47027-15	201
44842B31	396	44851-01	397	44878-24	72	44942-02	316	44970-10	469	44995-10	355	47027-16	201
44842-35	396	44851-02	397	44878B24	72	44942-03	316	44970-15	469	44995-14	355	47028-12	200
44842-53	396	44851-03	397	44882-35	401	44942-04	316	44970-20	469	44995-15	355	47029-12	200
44842B53	396	44871-20	315	44882-46	401	44942-05	317	44970-34	469	44997-22	104	47030-30	201
44843-11	396	44871B20	315	44884-12	426	44942-06	295	44972-20	469	44997-24	104	47031-44	198
44843B11	396	44871G20	315	44884B12	426	44942-07	295	44972-25	469	44997-26	104	47031-46	198
44843-12	396	44871L20	315	44884-19	426	44942-10	295	44972-33	469	44997-28	104	47032-10	201
44843B12	396	44871R20	315	44884B19	426	44942-11	295	44973-10	469	44998-31	104	47032-20	201
44843-13	396	44871-21	315	44884-25	426	44942-12	295	44973-20	469	44999-09	354	47033-08	201
44843B13	396	44871B21	316	44884B25	426	44944C07	303	44974-21	469	44999-16	354	47033-12	201
44843-14	396	44871G21	316	44885-19	426	44944G07	303	44974-27	469	46116-15	320	47033-14	201
44843B14	396	44871L21	316	44885-25	426	44945C05	303	44974-31	469	46118-20	367	47033-50	198
44843-24	396	44871R21	316	44888-32	401	44945G05	303	44975-35	276	46120-18	367	47034-23	201
44843B24	396	44871-22	315	44888-35	401	44946-04	408	44975H35	276	46120-22	367	47034-50	201
44844-01	395	44871-23	315	44888-40	401	44946B05	408	44975-50	276	46120-24	367	47034-51	201
44844B01	395	44871-28	316	44889-32	401	44947-00	165	44975C50	462	46123-00	369	47034-52	201
44844-11	395	44871-29	316	44889-35	401	44947-07	116	44975H50	276	46796-00	328	47035-40	201
44845-30	396	44871-30	316	44889-40	401	44948-07	306	44976-01	471	46970-18	28	47035-48	201
44845-31	288	44871-31	316	44930-10	472	44949-01	307	44976-02	471	46970-25	28	47036-30	201
44845-38	288	44871-32	316	44930-20	472	44949-02	307	44976-03	471	47005-24	212	47036-35	201
44845-41	396	44871-33	316	44932-15	472	44949-03	307	44976-04	470	47006-25	212	47036-40	201
44845-51	396	44871-34	316	44932-20	472	44949-04	307	44977-12	472	47007-26	217	47036-45	201
44846-05	395	44871-35	316	44934-30	472	44949-05	307	44978-10	469	47010-20	192	47036-50	201
44846B05	395	44873-08	288	44936-02	472	44949-06	307	44978-20	469	47011-01	205	47036-60	201
44846-09	395	44873-16	288	44936-20	472	44950-15	357	44979-02	470	47014-35	214	47037-30	201
44846B09	395	44874-08	289	44936-57	472	44950-20	357	44979-04	470	47018-30	214	47037-40	201
44846-13	395	44874-16	289	44940-01	313	44950-25	357	44979-05	470	47018-50	214	47038-50	201
44846B13	395	44877-11	72	44940-02	313	44950-30	357	44979-06	470	47020-15	191	47038-60	201
44846-15	395	44877B11	72	44940-06	313	44950-38	357	44982-04	255	47020-20	191	47039-05	202
44846B15	395	44877-12	73	44940-08	313	44960-01	277	44982-06	255	47020-30	191	47039-10	202

**NUMERICAL INDEX INDICE NUMERICO NUMERISCH INDEX INDEX NUMERIQUE INDICE NUMERICO**

Cod.	pag.	Cod.	pag.	Cod.	pag.	Cod.	pag.	Cod.	pag.	Cod.	pag.	Cod.	pag.
47039-15	202	47068-15	210	47105-60	191	47130-60	206	47302-10	171	47354-04	187	47357-44	188
47040-00	255	47069-10	210	47105-65	191	47131-30	206	47303-10	171	47354-06	187	47357-50	188
47041-01	254	47069-12	210	47105-70	191	47131-60	206	47304-06	171	47354-08	187	47357-51	188
47041-02	254	47069-14	210	47105-75	191	47200-01	190	47304-10	171	47354-10	187	47370-01	178
47041-03	254	47069-16	210	47106-28	191	47200-02	190	47304-12	171	47354-12	187	47370-02	178
47041-04	254	47069-18	210	47106-34	191	47207-20	187	47305-12	171	47354-14	187	47370-03	178
47041-05	254	47069-20	210	47106-40	191	47207-25	187	47306-10	171	47354-16	187	47370-08	173
47041-06	254	47070-37	204	47106-46	191	47207-30	187	47307-10	171	47354-18	187	47371-08	177
47041-07	254	47070-48	204	47106-50	191	47208-01	186	47308-10	171	47355-02	187	47372-08	174
47041-08	254	47070-60	204	47106-55	191	47208-02	186	47310-10	171	47355-04	187	47373-01	175
47041-15	254	47074-01	204	47106-60	191	47208-03	186	47312-10	171	47355-06	187	47373-02	178
47042-19	255	47074-02	204	47106-65	191	47208-04	186	47314-10	171	47355-08	187	47373-08	175
47042-22	255	47074-03	204	47106-70	191	47208-05	186	47315-10	171	47355-10	187	47374-01	178
47042-25	255	47074-04	204	47106-75	191	47208-06	186	47316-10	171	47355-12	187	47374-02	178
47043-27	255	47074-05	204	47107-00	193	47208-07	186	47316-12	171	47356-02	187	47374-08	178
47043-35	255	47074-06	204	47108-00	193	47208-08	186	47316-20	171	47356-04	187	47375-01	177
47043-42	255	47074-07	204	47110-23	193	47208-09	186	47317-10	171	47356-06	187	47375-08	177
47060-06	210	47074-08	204	47111-30	192	47208-10	186	47317-12	172	47356-08	187	47376-08	175
47060-07	210	47075-20	204	47111-40	192	47208-11	186	47317-20	172	47356-10	187	47377-01	176
47060-09	210	47075-30	204	47111-46	192	47208-12	186	47321-12	172	47356-12	187	47377-02	176
47060-10	210	47075-45	204	47111-55	192	47208-13	186	47322-12	172	47356-14	187	47377-03	176
47060-12	210	47090-23	288	47112-34	192	47208-14	186	47323-12	172	47356-16	187	47377-04	176
47060-14	210	47091-01	288	47112-45	192	47208-15	186	47324-12	172	47356-18	187	47377-05	176
47060-16	210	47091-02	288	47112-50	192	47208-16	186	47325-10	172	47357-01	185	47377-06	176
47060-18	210	47093-24	116	47113-03	193	47208-17	187	47326-10	172	47357-02	185	47377-07	176
47060-20	210	47094-30	193	47114-40	192	47208-18	187	47327-12	172	47357-03	185	47377-08	173
47060-22	210	47098-18	194	47114-55	192	47208-19	187	47328-15	172	47357-06	184	47377-09	175
47060-24	210	47098-22	194	47118-30	192	47208-20	187	47331-15	172	47357-07	184	47377-10	175
47060-26	210	47098-26	194	47118-40	192	47208-21	187	47332-12	172	47357-08	184	47377-11	176
47060-30	210	47098-30	194	47118-55	192	47208-22	187	47333-15	172	47357-09	184	47377-12	179
47062-18	210	47099-30	288	47118-65	192	47208-23	187	47334-12	172	47357-10	185	47377-15	179
47062-20	210	47100-03	407	47119-30	192	47208-24	187	47335-12	172	47357-11	185	47378-01	178
47062-22	210	47100-04	407	47119-35	192	47212-01	190	47336-42	172	47357-20	182	47378-02	178
47063-01	210	47100-05	407	47119-40	192	47212-02	190	47350-01	186	47357-21	182	47378-08	173
47063-02	210	47100-06	407	47119-45	192	47212-03	190	47351-01	186	47357-22	182	47379-08	173
47063-05	210	47100-07	407	47119-50	192	47212-05	190	47352-01	186	47357-23	183	47380-08	177
47063-07	210	47100-08	407	47119-60	192	47214-86	188	47353-02	187	47357-24	182	47381-08	178
47063-10	210	47101-30	193	47120-01	191	47215-86	188	47353-04	187	47357-25	183	47382-06	177
47064-18	210	47101-31	288	47120-02	191	47216-88	188	47353-06	187	47357-26	183	47382-08	175
47064-22	210	47101-40	193	47127-04	187	47219-29	189	47353-08	187	47357-27	183	47383-08	177
47064-26	210	47103-30	193	47127-06	187	47219-38	189	47353-10	187	47357-28	183	47384-01	177
47064-30	210	47103-32	193	47127-08	187	47219-55	189	47353-12	187	47357-29	183	47384-08	177
47066-03	210	47104-45	192	47130-25	206	47250-12	188	47353-14	187	47357-30	184	47385-01	178
47066-04	210	47105-28	191	47130-30	206	47250-24	188	47353-16	187	47357-31	184	47385-08	178
47066-05	210	47105-34	191	47130-35	206	47251-00	189	47353-18	187	47357-38	189	47386-08	177
47066-06	210	47105-40	191	47130-40	206	47251-01	189	47353-20	187	47357-40	188	47387-01	174
47066-07	210	47105-46	191	47130-45	206	47251-02	190	47353-22	187	47357-41	188	47387-02	175
47066-08	210	47105-50	191	47130-50	206	47251-03	190	47353-24	187	47357-42	188	47388-06	179
47068-12	210	47105-55	191	47130-55	206	47301-12	171	47354-02	187	47357-43	188	47388-07	179

Cod.	pag.	Cod.	pag.	Cod.	pag.	Cod.	pag.	Cod.	pag.	Cod.	pag.	Cod.	pag.
47388-08	179	47510-21	209	47532-14	206	47540-02	208	47604-20	105	47621-07	203	47655-04	220
47401-08	177	47510-23	209	47532-16	206	47540-03	208	47604-24	105	47621-08	203	47655-05	220
47402-01	174	47510-25	209	47532-18	206	47540-04	208	47604-30	105	47621-11	279	47655-07	220
47402-02	175	47510-27	209	47532-20	206	47540-05	208	47605-23	104	47621-12	279	47656-01	220
47402-08	174	47510-29	209	47532-22	206	47541-02	208	47606-02	105	47622-01	181	47656-02	220
47404-01	177	47510-31	209	47532-24	206	47541-03	208	47606-05	105	47622-02	181	47656-03	220
47404-02	177	47511-07	209	47532-26	206	47541-04	208	47606-10	105	47622-03	181	47656-04	220
47404-03	177	47511-09	209	47533-07	206	47542-00	207	47606-20	105	47622-04	180	47656-05	220
47404-04	177	47511-11	209	47533-08	206	47542-18	208	47606-30	105	47622-26	180	47656-07	220
47404-05	177	47511-13	209	47533-09	206	47542-20	208	47606-50	105	47625-03	203	47657-01	220
47404-08	177	47511-15	209	47533-10	206	47542-22	208	47607-10	105	47626-55	198	47657-02	220
47411-01	174	47511-17	209	47533-12	206	47542-24	208	47607-20	105	47627-01	198	47657-03	220
47411-02	174	47511-19	209	47533-14	206	47542-26	208	47608-02	105	47630-28	181	47657-04	220
47411-03	174	47511-21	209	47533-16	206	47544-20	208	47609-02	105	47631-08	181	47657-05	220
47411-08	173	47511-23	209	47533-18	206	47544-25	208	47609-03	105	47631-12	181	47657-07	220
47412-08	173	47511-25	209	47533-20	206	47544-30	208	47609-04	106	47640-25	202	47658-01	220
47413-01	174	47511-27	209	47533-22	206	47546-18	207	47609-07	106	47640-35	202	47658-02	220
47413-08	174	47511-29	209	47533-24	206	47546-21	208	47609-09	105	47642-30	202	47658-03	220
47414-03	172	47511-31	209	47533-26	206	47546-22	208	47609-12	106	47642-40	202	47658-04	220
47415-03	172	47512-07	209	47533-28	206	47546-23	208	47609-13	105	47642-50	202	47658-05	220
47416-06	172	47512-09	209	47533-30	206	47546-30	207	47609-16	106	47642-60	202	47658-07	220
47417-06	173	47512-11	209	47533-32	206	47546-40	207	47610-18	109	47642-70	202	47659-01	217
47418-00	173	47512-13	209	47534-00	207	47546-41	208	47610-22	109	47643-30	202	47659-02	217
47419-10	172	47512-15	209	47534-01	207	47546-42	208	47610-26	109	47643-40	202	47659-03	217
47421-09	179	47512-17	209	47534-06	207	47546-43	208	47610-30	109	47643-50	202	47659-04	217
47422-26	179	47512-19	209	47534-07	206	47546-51	208	47611-01	110	47643-60	202	47670-02	217
47425-01	179	47512-21	209	47534-08	206	47546-52	208	47611-03	110	47643-70	202	47672-05	217
47425-02	179	47512-23	209	47534-09	206	47546-53	208	47611-05	110	47644-15	202	47674-01	218
47425-03	179	47512-25	209	47534-10	206	47547-22	208	47611-06	110	47645-40	202	47674-02	218
47425-04	179	47512-27	209	47534-16	207	47547-26	208	47611-09	110	47645-60	202	47674-03	218
47425-05	179	47512-29	209	47534-18	207	47547-30	208	47611-11	110	47645-75	202	47674-04	218
47425-06	179	47512-31	209	47534-20	207	47548-02	207	47611-13	110	47646-40	202	47674-05	218
47425-08	179	47526-05	207	47534-22	207	47548-03	207	47611-14	110	47646-60	202	47674-06	218
47425-09	179	47527-55	207	47534-24	207	47548-04	207	47611-15	110	47646-75	202	47674-07	218
47425-10	179	47528-05	207	47534-26	207	47548-05	207	47611-16	110	47651-01	220	47674-08	218
47425-11	179	47529-07	207	47534-28	207	47600-16	110	47611-19	110	47651-02	220	47675-01	219
47425-26	179	47530-14	206	47535-09	209	47600-20	110	47611-23	110	47651-03	220	47675-02	219
47425-29	179	47530-16	206	47535-12	209	47600-24	110	47612-01	195	47651-04	220	47675-03	219
47425-30	179	47530-18	206	47535-15	209	47600-28	110	47612-AA	531	47651-05	220	47675-04	219
47425-32	179	47530-20	206	47535-17	209	47600-32	110	47614-25	203	47651-07	220	47675-05	219
47426-01	179	47530-22	206	47535-19	209	47600-36	110	47615-25	203	47652-01	220	47675-06	219
47426-07	179	47530-24	206	47536-12	209	47600-40	110	47618-10	188	47652-02	220	47675-07	219
47510-07	209	47530-26	206	47536-14	209	47603-25	104	47618-20	188	47652-03	220	47675-08	219
47510-09	209	47530-28	206	47536-16	209	47603-27	104	47621-01	202	47652-04	220	47675-09	219
47510-11	209	47530-30	206	47536-18	209	47604-08	105	47621-02	202	47652-05	220	47677-01	218
47510-13	209	47532-06	206	47536-20	209	47604-10	105	47621-03	202	47652-07	220	47677-02	218
47510-15	209	47532-07	206	47538-20	208	47604-12	105	47621-04	202	47655-01	220	47677-03	218
47510-17	209	47532-08	206	47538-23	208	47604-15	105	47621-05	203	47655-02	220	47677-04	218
47510-19	209	47532-12	206	47538-26	208	47604-18	105	47621-06	203	47655-03	220	47677-05	218

**NUMERICAL INDEX INDICE NUMERICO NUMERISCH INDEX INDEX NUMERIQUE INDICE NUMERICO**

Cod.	pag.	Cod.	pag.	Cod.	pag.	Cod.	pag.	Cod.	pag.	Cod.	pag.	Cod.	pag.
47677-06	218	47698-02	197	47723-10	215	47740-20	245	47740-74	240	47740127	241	47742-27	234
47677-07	218	47698-03	197	47723-12	215	47740-23	239	47740-75	240	47740128	239	47742-29	236
47677-08	218	47698-06	197	47724-06	215	47740-24	245	47740-77	242	47740129	248	47742-30	234
47677-09	219	47698-07	197	47724-08	215	47740-25	245	47740-79	246	47740130	242	47742-31	234
47677-10	219	47705-22	213	47724-10	215	47740-26	239	47740-80	239	47740131	243	47742-33	236
47677-11	219	47709-20	212	47724-11	215	47740-27	239	47740-81	243	47740132	241	47742-34	235
47677-12	219	47709-24	212	47725-09	215	47740-28	239	47740-82	243	47740133	243	47742-37	235
47677-14	219	47709-28	212	47726-07	214	47740-29	239	47740-83	240	47740134	248	47742-41	234
47677-18	219	47709-32	212	47727-07	214	47740-30	244	47740-84	247	47740135	240	47742-42	235
47677-19	219	47710-12	212	47728-06	214	47740-31	246	47740-85	244	47740137	239	47742-47	236
47677-20	219	47710-16	212	47730-24	215	47740-32	243	47740-86	247	47740138	239	47742-48	236
47679-10	203	47710-20	212	47730-36	215	47740-33	247	47740-87	246	47740140	241	47742-51	235
47679-11	203	47710-24	212	47730-60	215	47740-34	243	47740-88	248	47740141	239	47742-56	235
47680-40	205	47710-28	212	47731-12	216	47740-35	248	47740-89	241	47740142	243	47742-61	236
47680-53	205	47710-32	212	47732-20	216	47740-36	245	47740-90	247	47740143	243	47743-03	249
47680-60	205	47711-08	212	47733-18	213	47740-37	241	47740-91	247	47740144	242	47743-05	249
47681-60	204	47711-12	212	47733-24	213	47740-38	241	47740-92	244	47740145	245	47743-10	249
47682-53	204	47711-22	212	47733-30	213	47740-39	244	47740-93	239	47741-00	249	47743-13	249
47682-60	204	47711-24	212	47733-36	213	47740-41	242	47740-94	242	47741-01	250	47743-15	249
47684-15	217	47711-26	212	47734-18	213	47740-43	240	47740-95	241	47741-02	250	47743-16	249
47685-53	205	47712-20	212	47735-18	213	47740-44	243	47740-96	248	47741-05	250	47743-65	249
47685-60	205	47712-24	212	47736-30	214	47740-45	244	47740-97	242	47741-37	250	47744-10	251
47686-10	193	47712-28	212	47736-35	214	47740-46	244	47740-98	246	47741-38	250	47744-19	251
47686-12	193	47712-32	212	47736-40	214	47740-47	244	47740-99	246	47741-76	249	47744-21	251
47686-14	193	47713-22	213	47736-50	214	47740-48	244	47740100	246	47741-77	249	47744-30	250
47686-17	193	47714-26	213	47738-23	213	47740-49	244	47740101	242	47741-78	249	47744-31	250
47686-22	193	47714-28	213	47739-12	212	47740-50	242	47740102	240	47742-00	237	47744-32	250
47686-24	193	47715-30	213	47739-24	212	47740-51	246	47740103	240	47742-01	236	47744-33	250
47686-26	193	47716-37	214	47739-28	212	47740-52	240	47740104	244	47742-02	234	47744-34	250
47686-30	193	47717-35	213	47739-32	212	47740-53	248	47740105	239	47742-03	236	47744-36	251
47686-33	193	47718-20	213	47740-01	246	47740-55	244	47740106	243	47742-04	236	47744-37	251
47686-36	193	47719-10	213	47740-02	241	47740-56	245	47740107	247	47742-05	236	47744-48	251
47686-42	193	47719-24	213	47740-03	241	47740-57	241	47740108	248	47742-06	236	47744-58	251
47687-24	193	47720-06	215	47740-04	244	47740-58	241	47740109	247	47742-07	236	47744-59	251
47688-60	205	47720-08	215	47740-05	245	47740-59	241	47740110	248	47742-08	236	47744-60	251
47689-53	204	47720-10	215	47740-06	240	47740-60	240	47740111	243	47742-09	235	47744-62	251
47689-60	204	47720-12	215	47740-07	247	47740-61	240	47740112	248	47742-10	236	47744-63	251
47691-53	204	47721-08	215	47740-08	247	47740-62	245	47740113	249	47742-12	234	47744-70	251
47691-64	204	47721-10	215	47740-09	246	47740-63	245	47740114	245	47742-13	235	47744-71	251
47692-01	199	47721-12	215	47740-10	240	47740-64	245	47740115	246	47742-14	235	47744-80	250
47692-02	199	47722-05	215	47740-11	246	47740-65	245	47740116	247	47742-15	236	47744-81	250
47692-03	199	47722-06	215	47740-12	247	47740-66	245	47740117	248	47742-16	236	47745-02	233
47693-00	199	47722-07	215	47740-13	244	47740-67	246	47740118	248	47742-17	235	47745-03	233
47693-03	199	47722-08	215	47740-14	247	47740-68	243	47740119	240	47742-19	235	47745-04	233
47693-05	199	47722-10	215	47740-15	245	47740-69	240	47740121	242	47742-20	235	47745-05	233
47693-10	199	47723-05	215	47740-16	241	47740-70	240	47740122	242	47742-21	235	47745-06	232
47693-15	199	47723-06	215	47740-17	242	47740-71	245	47740123	242	47742-23	235	47745-07	232
47694-03	195	47723-07	215	47740-18	240	47740-72	245	47740124	242	47742-24	236	47745-08	232
47698-01	197	47723-08	215	47740-19	243	47740-73	248	47740125	241	47742-25	235	47745-09	232

Cod.	pag.	Cod.	pag.	Cod.	pag.	Cod.	pag.	Cod.	pag.	Cod.	pag.	Cod.	pag.
47745-10	232	47770-21	237	47832-14	421	47860-63	224	47862-31	225	47870-18	229	48238-00	365
47746-01	233	47771-28	237	47832-15	421	47860-66	224	47862-32	225	47870-19	229	48239-00	365
47746-02	233	47773-24	237	47833-04	181	47860-67	224	47862-33	225	47875-11	221	48240-00	365
47746-03	233	47773-28	237	47833-10	181	47860-68	224	47862-34	225	47875-13	221	48241-14	373
47746-04	233	47783-01	221	47837-09	181	47860-69	224	47862-35	225	47875-14	221	48242-09	373
47747-01	215	47783-02	221	47838-00	197	47860-70	224	47862-36	225	47876-11	230	48244-04	373
47747-03	215	47783-03	221	47840-11	196	47860-71	224	47862-38	225	47876-12	230	48244-07	373
47747-04	216	47783-04	221	47841-03	197	47860-73	224	47862-39	225	47876-13	230	48245-10	373
47747-05	216	47783-11	221	47841-04	197	47860-74	224	47862-64	226	47876-14	230	48245-75	373
47747-06	215	47783-12	221	47842-00	198	47860-75	225	47862-65	226	47876-15	230	48247-10	372
47747-07	216	47783-13	221	47843-00	128	47860-76	228	47862-66	226	47876-16	230	48249-13	372
47747-09	216	47783-14	221	47843-05	128	47860-77	228	47862-67	226	47876-17	230	48250-10	372
47747-10	215	47793-11	231	47844-01	196	47860-78	228	47862-70	227	47876-18	230	48250-12	372
47747-11	215	47793-12	231	47844-02	196	47860-81	225	47862-71	227	47885-01	121	48251-03	372
47748-35	216	47793-13	231	47844-06	196	47860-83	225	47862-72	227	47885-02	121	48252-10	372
47749-35	217	47793-15	231	47846-10	196	47860-84	225	47862-73	227	47885-03	121	48252B10	372
47750-06	216	47793-16	231	47847-10	196	47860-85	225	47862-74	227	47885-04	121	48252-12	372
47751-23	212	47793-18	231	47847-12	196	47860-86	228	47862-75	227	47885-05	122	48252B12	372
47752-09	214	47793-20	231	47847-23	196	47860-90	229	47862-76	227	48017-14	152	48253-09	372
47752-16	214	47793-23	231	47848-07	196	47860-91	229	47862-77	227	48017-25	152	48253B09	372
47752-21	214	47793-26	231	47859-01	284	47860-92	229	47862-80	230	48021-21	152	48278-01	90
47753-31	214	47793-32	231	47859-02	284	47860-93	229	47862-81	230	48032-30	160	48278-02	90
47754-20	217	47793-33	231	47859-03	284	47860-94	229	47862-82	230	48032-45	160	48278-03	91
47754-24	217	47793-40	231	47860-17	222	47860-95	225	47862-83	230	48032-60	160	48278-11	92
47754-26	217	47793-43	231	47860-18	223	47860-96	225	47862-84	230	48039-06	160	48278-12	89
47754-28	217	47793-45	231	47860-21	223	47861-02	222	47862-85	230	48040-00	160	48278-13	89
47755-26	217	47793-52	231	47860-24	223	47861-03	222	47862-86	230	48040-10	160	48278-14	94
47756-20	217	47793-55	231	47860-27	223	47861-04	222	47862-87	230	48040-50	160	48278-15	92
47756-24	217	47800-22	195	47860-31	223	47861-05	222	47862-88	230	48040-AA	160	48278-16	91
47756-26	217	47801-20	195	47860-35	223	47861-06	222	47862-89	230	48210-00	365	48278-17	91
47756-28	217	47820-05	200	47860-36	223	47861-07	222	47863-01	228	48211-00	365	48278-18	94
47757-65	215	47820-07	200	47860-37	223	47861-08	222	47863-02	228	48215-14	153	48278-19	94
47757-80	215	47821-05	200	47860-38	223	47861-09	222	47863-03	228	48215-30	153	48278-20	90
47758-10	213	47821-07	200	47860-39	223	47861-10	222	47863-04	228	48218-00	115	48278-21	90
47758-12	213	47822-05	200	47860-40	223	47861-11	222	47865-23	230	48220-00	124	48278-24	88
47759-12	214	47822-07	200	47860-42	223	47861-12	222	47865-44	230	48222-01	124	48278-25	91
47760-12	214	47830-05	200	47860-43	223	47861-13	222	47865-66	230	48223-00	330	48278-27	93
47761-23	216	47830-07	200	47860-44	223	47861-14	222	47865-71	230	48231-40	163	48278-28	94
47762-23	216	47831-02	106	47860-46	223	47861-15	222	47865-72	230	48231-45	163	48278-31	90
47763-31	216	47832-00	420	47860-48	223	47861-16	228	47865-73	230	48231-50	163	48278-32	88
47764-12	217	47832-01	292	47860-49	223	47862-03	226	47865-74	230	48232-40	531	48278-33	88
47764-28	217	47832-02	420	47860-50	223	47862-04	226	47865-75	230	48232-45	531	48278-34	91
47765-24	236	47832-03	292	47860-53	224	47862-05	226	47865-76	230	48232-50	531	48278-35	91
47765-26	236	47832-04	292	47860-55	224	47862-06	227	47865-77	230	48236-00	359	48278-36	92
47765-28	236	47832-05	292	47860-56	224	47862-07	227	47865-80	230	48236-01	359	48278-37	90
47766-26	236	47832-10	421	47860-58	224	47862-08	227	47865-81	230	48237-00	359	48278-38	89
47766-28	236	47832-11	421	47860-60	224	47862-09	227	47865-82	230	48237-01	359	48278-39	88
47766-30	236	47832-12	421	47860-61	224	47862-10	227	47865-83	230	48237-35	359	48278-41	89
47769-28	237	47832-13	421	47860-62	224	47862C10	227	47870-17	229	48237-99	359	48278-42	89



**NUMERICAL INDEX INDICE NUMERICO NUMERISCH INDEX INDEX NUMERIQUE INDICE NUMERICO**

Cod.	pag.	Cod.	pag.	Cod.	pag.	Cod.	pag.	Cod.	pag.	Cod.	pag.	Cod.	pag.
48278-45	90	48280-15	87	48286-62	117	48362-01	331	48520-30	169	49336-00	480	49605-61	265
48278-46	89	48280-20	84	48286-64	117	48363-01	331	48522-24	169	49336-02	480	49605-71	265
48278-47	91	48280-21	84	48286-67	86	48364-09	331	48523-01	168	49337-00	480	49606-00	267
48278-48	89	48280-22	85	48286-68	365	48364-12	331	48523-02	168	49337-01	480	49606-01	267
48278-49	89	48280-23	88	48286-70	119	48365-09	297	48523-03	168	49371-09	487	49606-51	267
48278-52	91	48280-24	86	48287-18	372	48366-09	297	48523-04	168	49371-12	487	49607-15	269
48278-53	91	48280-25	88	48287-19	372	48367-10	296	48524-75	169	49373-01	466	49607-20	269
48278-54	91	48280-26	86	48288-02	116	48368-05	341	48525-03	169	49373-02	466	49607-25	269
48278-55	89	48280-27	158	48288-03	116	48368-12	341	48526-44	169	49373-03	466	49607-30	269
48278-61	93	48280-30	86	48289-10	115	48368-20	341	48527-00	169	49373-04	466	49608-15	269
48278-62	93	48280-31	86	48290-10	255	48369-08	341	48528-00	169	49373-05	487	49608-20	269
48278-63	93	48280-32	84	48294-01	122	48369-14	341	48529-00	169	49373-11	466	49608-25	269
48278-64	92	48280-34	87	48294-02	122	48369-20	341	48543-01	325	49373-12	466	49608-30	269
48278-65	93	48280-35	86	48294-03	122	48370-10	297	48543-02	325	49373-13	466	49608-35	269
48278-66	92	48280-36	86	48294-04	122	48370-11	297	48550-00	489	49373-14	466	49609-12	269
48278-68	92	48280-37	85	48295-10	118	48371-10	296	48551-00	489	49373-90	466	49609-14	269
48278-69	92	48280-38	84	48300-29	262	48371-11	296	48601-05	489	49378-00	478	49610-11	269
48278-71	93	48280-39	84	48300-33	262	48372-08	341	48610-50	484	49378-48	487	49610-14	269
48278-73	93	48280-41	85	48300-42	262	48373-06	296	48701-08	494	49379-00	478	49612-30	265
48278-74	93	48280-45	84	48300-43	262	48373-09	296	48701-12	494	49381-01	466	49612-33	265
48278-75	90	48280-46	85	48306-01	331	48373-12	296	48710-01	492	49381-02	466	49613-30	265
48278-76	93	48280-47	87	48307-01	161	48373-17	296	48710-02	492	49381-03	466	49613-33	265
48278-77	90	48280-48	84	48307-02	161	48501-76	167	48710-03	492	49382-10	466	49613-35	265
48278-81	94	48280-49	85	48307-03	161	48505-01	167	48710-04	492	49382-23	466	49614-28	267
48278-82	94	48280-52	87	48310-14	308	48505-02	167	48710-05	492	49382-47	466	49615-01	267
48278-83	94	48280-53	87	48310-20	308	48505-03	167	48710-06	492	49384-03	466	49616B01	267
48278-84	94	48280-54	86	48311-20	308	48506-01	167	48710-07	492	49384-04	466	49616S01	267
48278-85	94	48280-59	85	48311-25	308	48506-02	167	48710-08	492	49384-05	466	49616-22	267
48278-87	89	48280-60	87	48312-25	308	48506-03	167	48710-09	492	49384-06	466	49616-24	267
48278-88	94	48280-61	87	48313-14	308	48510-00	167	48711-01	493	49384-07	466	49616-26	267
48278-89	94	48280-62	87	48313-18	308	48511-02	168	48711-02	493	49384-11	466	49617-23	269
48278-91	92	48280-63	87	48313-20	308	48512-02	168	48711-03	493	49384-14	466	49617-25	269
48278-92	92	48280-75	85	48350-01	297	48513-02	168	48711-04	493	49384-15	466	49617-30	269
48278-93	93	48280-85	87	48350-02	297	48514-00	167	48711-05	493	49600-00	265	49618-12	268
48278-94	90	48280-90	88	48350-03	297	48515-09	168	48711-06	493	49601-14	268	49618-15	268
48278-95	91	48280-91	88	48350-04	297	48515-11	168	48711-07	493	49602-25	265	49618-18	268
48278-96	91	48280-92	88	48351-01	298	48515-12	168	48711-08	493	49602-30	265	49626-00	263
48278-99	92	48280-94	85	48351-02	298	48516-07	168	48711-09	493	49602-33	265	49626-02	263
48280-02	86	48280-95	88	48351-03	298	48516-08	168	48712-08	493	49602-35	265	49627-22	262
48280-03	86	48280-96	87	48352-01	298	48516-09	168	48712-10	493	49603-15	264	49628-00	262
48280-04	84	48280-97	87	48352-02	298	48517-03	168	48713-08	493	49603-20	264	49629-45	269
48280-05	84	48281-22	118	48352-03	298	48518-01	168	48713-10	493	49603-25	264	49630-06	503
48280-06	86	48281-23	118	48353-01	297	48518-02	168	48713-15	493	49603-30	264	49630-08	503
48280-08	87	48282-21	118	48354-01	297	48519-01	169	48714-19	493	49603-40	264	49632-24	267
48280-09	85	48285-04	119	48355-01	342	48519-02	169	48715-07	494	49603-50	264	49632-32	267
48280-10	86	48285-05	119	48356-01	342	48519-03	169	48716-07	494	49604-31	265	49633-22	267
48280-11	87	48286-03	121	48357-01	342	48519-04	169	49304-06	463	49604-36	265	49633-24	267
48280-12	85	48286-08	121	48358-01	342	48520-20	169	49335-01	480	49604-41	265	49634-00	269
48280-13	85	48286-13	121	48359-01	342	48520-23	169	49335-02	480	49605-46	265	49635-00	269

Cod.	pag.	Cod.	pag.	Cod.	pag.	Cod.	pag.	Cod.	pag.	Cod.	pag.	Cod.	pag.
49636-00	155	49655-51	262	49719-00	132	49814-00	126	49838-08	114	49850-71	500	49884-08	130
49637-00	268	49655-52	261	49720-00	132	49814-01	531	49838-98	114	49850-73	501	49885-02	129
49638-00	269	49655-53	262	49721-03	132	49815-00	125	49838-AB	532	49850-75	501	49887-00	129
49652-10	265	49655-54	261	49723-00	133	49817-00	115	49839-00	113	49850-76	501	49887-02	129
49652-12	265	49655-55	261	49726-00	489	49818-00	114	49842-00	114	49851-10	513	49888-10	111
49652-15	265	49655-56	261	49729-00	131	49818-AC	114	49843-00	115	49854-03	444	49888-20	111
49652-17	265	49655-57	261	49730-00	133	49818-AD	114	49843-05	124	49854-06	444	49889-09	109
49652-20	265	49655-58	261	49730-20	132	49818-AE	114	49844-01	123	49855-05	444	49889-12	109
49653-10	265	49655-60	261	49731-10	133	49818-AF	114	49845-01	113	49855-10	445	49889-15	109
49653-12	265	49655-61	262	49731-99	133	49819-00	114	49846-05	445	49855-15	445	49892-40	488
49653-15	265	49655-64	266	49733-00	132	49819-01	114	49846-09	445	49856-04	444	49897-09	488
49653-17	265	49655-66	266	49734-00	132	49819-02	114	49846-15	445	49858-00	329	49898-30	488
49653-20	265	49656-02	266	49735-00	132	49820-05	113	49847-08	446	49858-01	329	49899-01	487
49654-15	265	49656-15	264	49739-00	160	49821-08	114	49847-38	445	49858-06	329	49899-91	487
49654-20	265	49656-16	264	49741-07	520	49823-00	120	49850-03	505	49858-07	329	49899-92	487
49654-25	265	49656-20	264	49741-15	520	49823-89	120	49850-06	502	49858-AA	532	49899-93	487
49655-02	263	49657-15	266	49750-00	115	49823-99	121	49850-10	502	49859-00	329	49899-94	487
49655-03	263	49657-20	266	49752-00	119	49825-05	120	49850-11	500	49860-00	330	49899-95	487
49655-10	263	49657-25	266	49753-06	119	49827-03	121	49850-12	501	49864-03	135	49899-AA	533
49655-16	263	49658-01	262	49753-09	119	49827-77	120	49850-13	500	49864-05	135	49907-01	506
49655-20	259	49658-02	262	49755-10	119	49827-99	120	49850-14	500	49864-20	135	49907-06	506
49655-21	259	49659-24	265	49760-00	113	49829-11	119	49850-18	499	49865-06	135	49907-AA	506
49655-22	259	49659-26	265	49771-00	135	49829-BA	532	49850-19	499	49865-70	135	49911-19	507
49655-23	259	49660-09	264	49772-01	135	49830-00	532	49850-20	498	49867-01	126	49911-24	507
49655-24	259	49660-13	264	49773-05	135	49830-02	532	49850-21	499	49867-02	126	49911-30	507
49655-25	261	49661-22	264	49774-05	135	49830-60	119	49850-22	499	49870-AA	533	49911-35	507
49655-26	261	49661-24	264	49775-05	136	49830-AA	532	49850-23	499	49871-10	520	49911-45	507
49655-27	262	49662-40	264	49775-10	136	49830-AB	532	49850-24	504	49871-20	520	49916-25	507
49655-28	262	49662-50	264	49776-15	136	49830-AC	532	49850-25	504	49872-00	520	49916-35	507
49655-29	260	49663-22	264	49776-30	136	49831-10	117	49850-26	504	49875-06	160	49916-45	507
49655-30	262	49663-24	264	49777-50	136	49832-02	117	49850-27	504	49876-03	164	49916-55	507
49655-31	260	49664-01	263	49779-15	136	49832-10	117	49850-28	504	49879-37	124	49921-00	518
49655-32	260	49664-02	263	49779-30	136	49832-80	532	49850-29	504	49879-90	533	49922-01	509
49655-34	259	49664-03	263	49790-09	446	49832-86	532	49850-30	504	49879-91	533	49922-02	509
49655-35	260	49664-04	263	49801-04	498	49832-88	532	49850-31	504	49879-92	533	49922-03	509
49655-36	259	49664-05	263	49801-06	498	49832-90	532	49850-33	500	49879-93	533	49922-04	509
49655-37	259	49701-00	129	49802-04	498	49832-96	532	49850-36	501	49879-94	533	49922-06	509
49655-38	266	49702-00	129	49802-06	498	49832-98	532	49850-37	502	49880-10	131	49922-08	510
49655-40	266	49703-00	132	49803-02	498	49832-99	532	49850-39	502	49880-11	131	49922-09	510
49655-41	259	49703-01	198	49804-11	445	49833-00	415	49850-41	501	49880-12	131	49922-20	510
49655-42	261	49705-00	128	49806-00	499	49834-00	115	49850-42	502	49880-13	131	49922-21	510
49655-43	261	49709-03	128	49807-00	506	49834-01	532	49850-43	502	49880-14	131	49922-22	510
49655-44	259	49710-00	129	49808-00	507	49834-02	532	49850-44	502	49880-15	131	49922-23	510
49655-45	260	49711-00	130	49809-00	504	49835-00	115	49850-61	500	49881-01	131	49923-00	321
49655-46	259	49712-00	128	49811-00	126	49835-01	532	49850-63	503	49881-02	131	49923-01	321
49655-47	259	49715-00	130	49811-01	531	49835-02	532	49850-65	498	49881-11	131	49923-02	321
49655-48	259	49716-00	130	49811-02	531	49836-00	115	49850-66	498	49881-12	131	49931-00	485
49655-49	264	49717-00	130	49812-00	126	49837-05	113	49850-69	502	49881-99	131	49931A00	486
49655-50	264	49718-00	132	49812-01	531	49837-AA	532	49850-70	502	49883-00	130	49931B01	486

**NUMERICAL INDEX INDICE NUMERICO NUMERISCH INDEX INDEX NUMERIQUE INDICE NUMERICO**

Cod.	pag.	Cod.	pag.	Cod.	pag.	Cod.	pag.	Cod.	pag.	Cod.	pag.
49931B02	486	49963-08	491	49996-05	456	66374-00	286				
49931B03	486	49963-09	491	49997-12	512	66391-00	287				
49931C04	486	49963-11	491	49997-13	512	67303M01	260				
49931B05	486	49963-13	491	49998-20	514	67303M02	261				
49931-60	485	49963-15	491	49998-35	514	67303M03	261				
49931-64	486	49963-17	491	52550F63	524	67303M04	260				
49931-87	485	49963-19	491	52550F73	525	67303M05	261				
49933-30	485	49963-21	491	52550F78	525	67303M06	261				
49933-50	485	49971R00	164	52550F80	525	67303M07	261				
49933-68	485	49971-25	164	52550F88	525	67303-64	286				
49934-04	487	49971M25	164	66303-01	286	67303Q80	260				
49934-06	487	49971P25	164	66303-03	286	67303Q81	260				
49934-08	487	49971R25	164	66303-06	286	67303Q82	260				
49934-14	487	49972-30	164	66307-06	286	67303Q83	260				
49934-16	487	49972M30	164	66307-09	286	67305-57	260				
49934-18	487	49972P30	164	66307-12	286	67308-57	260				
49940-01	507	49972R30	164	66313-03	286	XO1046	533				
49942-01	507	49974-25	519	66313-06	286						
49942-03	508	49974U25	519	66318-19	287						
49943-01	508	49974-30	519	66318-22	287						
49943-02	508	49974U30	519	66320-28	412						
49944-01	508	49975-19	518	66320-35	412						
49944-02	508	49975U19	518	66320-40	412						
49945-05	512	49975-22	518	66320-50	412						
49946-01	508	49975U22	518	66320-65	412						
49947-08	512	49975-25	518	66320-85	412						
49949-09	510	49975U25	518	66320-99	412						
49949-19	503	49975-30	519	66324-40	412						
49949-20	507	49975U30	519	66324-50	412						
49952-08	513	49975-35	519	66324-65	412						
49953-02	503	49975U35	519	66324-85	412						
49954-18	512	49978-10	164	66324-99	412						
49954-20	512	49978-13	164	66325-30	412						
49954-21	511	49979-03	503	66325-35	412						
49954-22	513	49986-00	130	66325-41	412						
49955-01	511	49987-00	130	66325-46	412						
49956-01	511	49988-00	130	66325-54	412						
49956-AA	533	49993-01	505	66325-85	412						
49957-00	511	49993-02	505	66325-99	412						
49958-00	510	49993-03	505	66326-30	412						
49959-00	511	49993-11	505	66326-35	412						
49960-00	511	49993-12	505	66326-40	412						
49961-01	490	49993-13	505	66326-60	412						
49961-02	490	49993-21	505	66326-80	412						
49961-10	490	49993-22	505	66339-02	287						
49963-01	490	49993-23	505	66345-55	412						
49963-03	491	49995-04	455	66345-65	412						
49963-04	491	49996-00	456	66345-74	412						
49963-06	491	49996-01	456	66362-02	361						

# SALES CONDITIONS

CONDIZIONI DI VENDITA

LIEFERBEDINGUNGEN

CONDITIONS DE VENTE

CONDICIONES DE VENTA



## General Sales Terms & Conditions

- All orders are subject to approval and acceptance by Sambonet Paderno Industrie S.p.A.
- Minimum order € 250,00 net.
- Standard packaging included in the price.
- These general sales terms & conditions may be modified only by an agreement in writing.

## Ownership & Payment Terms

- All goods remain the sole property of the Sambonet Paderno Industrie S.p.A. until payment has been made in full.
- Title to the ownership of any delivered good shall be transferred to the client upon full payment of the price set forth in the invoice. Payment becomes due within the payment term agreed upon by the parties. Should any amount to be paid by the client become overdue, the client shall pay a late payment interest pursuant to art. 5 D.LGS. 231/2002, as subsequently amended pursuant D.LGS. 192/2012, plus an 8% interest rate.

## Offers/Orders

- Any offer of Sambonet Paderno Industrie S.p.A shall not be binding.
- The written acceptance of any offer, or the order confirmation (according to the sales conditions included in it), constitutes a valid purchase order in accordance with the general sales terms & conditions, for all the purposes thereof.

## Returns/Complaints

- Goods must be inspected at the time of delivery.
- Should any good be damaged or defected, the waybill shall be signed with reserve, specifying the relevant reason (pictures of the good displaying the batch number, the courier and a description of the defect must be presented).
- Product returns must be made within 15 days of invoice date, subject to the following conditions:
  - claims and complaints must be made through the guided procedure available on our website, [www.agenti.sambonet.it](http://www.agenti.sambonet.it), under the user section;
  - Goods are delivered ex works - at our premises in Orfengo;
  - In case of customer liability, Sambonet Paderno Industrie S.p.A. will charge 15% of the net value of the goods, with a minimum of € 25.00 for handling charges;
  - In case goods are returned due to our fault, Sambonet Paderno Industrie S.p.A. will replace them free of charge;
  - client will be responsible for all shipping costs for products purchased out of warranty that need to be returned for repairs;
  - customized (not included in our catalogue), Tailor Made engraved, with extra personalization and discontinued items cannot be returned.

## Order Cancellation

- Cancellation is not allowed in case of discontinued, custom designed, and non-stock items.
- Catalogue items can be cancelled only if the purchase order has not yet been confirmed.

## Delivery Terms in the following EU Countries:

### Belgium, Netherlands, Luxembourg, France, Spain, Germany

- Goods are delivered **ex works** for orders having a net invoice value under € 500,00;
- Goods are **delivered at client's place**:
  - with a charge of € 60,00 for orders with a net value between € 500,00 and € 1,000,00;
  - free of charge for orders with a net value over € 1,000,00.
- Above delivery terms are valid only for shipments executed through our fixed forwarding agent.

### Delivery Terms in other EU Countries (islands excluded):

- Goods are delivered ex works for orders having an invoice value under € 500,00;
- Goods are delivered at client's place:
  - with a charge of € 60,00 for orders with net value between € 500,00 and € 1,500,00;
  - free of charge for orders with a net value over € 1,500,00.
- Above delivery terms are valid only for shipments executed through our fixed forwarding agent.

### Delivery Terms for Extra EU Countries (islands excluded):

- Goods are delivered ex works.

## Personalisations (The costs indicated are net)

- Sambonet Paderno Industrie S.p.A. makes customizations and special executions at the customer's request under the following conditions:
  - advance payment of 30%** on the value of the order;
  - delivery to be agreed after approval of the executive design and/or the sample;
  - Sambonet Paderno Industrie S.p.A. reserves the right to apply a **tolerance** in quantity of +/- 10% (rounded up) for each item ordered;
  - Sambonet Paderno Industrie S.p.A. shall provide the Customer with a form indicating all the necessary parameters (design, position, dimensions, etc.) and shall proceed with the supply only upon receipt of the same signed for acceptance.
- Sawing of fruit knife blades: if not standard, € 0.65 per piece will be charged.
- Pantograph/Laser engraving:
  - plant cost: € 70,00;
  - engraving cost: cutlery € 0.50 per piece - holloware € 1.00 per piece.
  - minimum quantities: cutlery 100 pcs - holloware 10 pcs.
- Stamping:
  - die costs: € 300,00 for the first die - additional dies € 150,00 each;
  - stamping costs: cutlery € 0.50 per piece - holloware will be quoted upon request;
  - minimum quantities:
    - first order: cutlery 1,000 pieces per item - hollow handle knives 800 pieces per item;
    - for further orders: cutlery 100 pieces per item - hollow handle knives 800 pieces per item.

## Sambonet Tailor Made personalizations (The costs indicated are net)

- Type of standard Tailor Made engravings:
  - On the front terminal: one of the standard logos, or the monogram (two letters) using one of the standard characters;
  - On the rear terminal: the date in the standard format, using one of the standard characters;
- Tailor Made engraving cost:
  - € 19.90 for engravings on the front terminal;
  - € 19.90 for engravings on the rear terminal;
  - € 39.80 for engraving on both the front and rear terminals.
- Minimum purchase order for Tailor Made loose items:
  - 6 pcs for nickel-silver items, multiples of 6 pcs;
  - 12 pcs for all other items, multiples of 12 pcs.
- Application of the Tailor Made engraving cost on the single purchase order:
  - A single cost per type of engraving, as set out in point 2;
  - A single cost regardless of the number of pcs, if higher than the minimum purchase indicated in point 3;
  - One cost regardless of the number of pcs up to 150 pcs.
  - Above 150 pcs and at multiples of 150 pcs the cost of engraving will be applied again.

## Special conditions for personalisations

- The Company reserves the right not to carry out the customization if it considers it not technically executable.
- Customized orders and special executions cannot be cancelled.
- Customized products cannot be returned for replacement.
- Requests for specific packaging will be charged to the Customer.

## Marketing

- The goods are intended for marketing in the Country where the customer is based. If the goods are sold in a different Country, the client shall undertake to verify the regulations applicable to the goods in such Country, including customs and import rules, as well as the risk of disputes by third parties for an reason whatsoever. It being understood that the client shall hold Sambonet Paderno Industrie S.p.A. harmless of any claim and/or legal action from third parties arising by the sale of the goods in such different Country.
- Sambonet Paderno Industrie S.p.A. does not provide any guarantee regarding possible infringement of intellectual property rights of third parties, in particular in the event of resale of the goods over the internet.
- It is prohibited to publish prices lower than the price lists in force on websites without authentication.

## Retention of title and payment terms

- Any complaints shall not in any case have the effect of deferring or suspending payments.
- Any payment delays shall therefore render the Customer a debtor by law to Sambonet Paderno Industrie S.p.A. of a lump sum indemnity for reminder costs of € 40,00. If the reminder costs exceed the aforementioned amount, Sambonet Paderno Industrie S.p.A. will have the right to claim a further indemnity.
- In the event of non-payment of all or part of the invoice, or of any deterioration in the Customer's financial situation, Sambonet Paderno Industrie S.p.A. will also have the right to:
  - suspend or cancel the orders and deliveries in progress;
  - request advance payment for further orders and/or payment guarantees.

## Delivery

- The delivery deadlines are indicated as accurately as possible but they depend upon the procurement and transportation conditions of Sambonet Paderno Industrie S.p.A., which undertakes to apply the utmost diligence in order to respect the deliveries, subject to causes of force majeure.
- If the planned delivery deadlines are exceeded, Sambonet Paderno Industrie S.p.A. shall not be required to pay any penalty, damages compensation or interest.
- Any change to the order will lead to a consequent change to the delivery date.
- The following are considered to be causes of force majeure, which release Sambonet Paderno Industrie S.p.A. from the delivery obligation: war, revolt, fire, strikes, impossibility of procurement, particularly significant incidents involving equipment, machine breakdowns, interruption or delay in transportation.
- Sambonet Paderno Industrie S.p.A. will keep the Customer informed of any delay. In any case, the delivery within the deadlines may only be made if the Customer has precisely fulfilled all its obligations towards Sambonet Paderno Industrie S.p.A., whatever the cause.
- It is, moreover, agreed between the parties that if the Customer does not take possession of the ordered products under the established conditions, Sambonet Paderno Industrie S.p.A. will invoice to the Customer:
  - any additional transportation and/or storage cost;
  - custody costs equivalent to 5% of the order amount, excluding taxes, for each month of delay.

## Important notice

- Considering that different operations are processed manually, some slight differences between same products of different lots may be noticed.
- Products undergone PVD processing may be subject to slight colour and shade variations between different models or between different references. These variations are not to be considered as defects as they are within the established tolerance limits and they are closely monitored.
- Errors may occur during the printing stage. Sambonet Paderno Industrie S.p.A. reserves the right to correct printing or calculation errors.
- The pictures illustrated and data are representatives. Sambonet Paderno Industrie S.p.A. reserves the right to alter at any time the specifications stated without notice.
- The shapes of cutlery illustrated in this publication are representatives and are not to be considered as the real shape.

## COPYRIGHT

© This catalogue may not be reproduced in whole or in part unless specific prior written authorization of Sambonet Paderno Industrie S.p.A.

## ITA

### Condizioni Generali e Termini di Vendita

1. Gli ordini sono soggetti ad approvazione di Sambonet Paderno Industrie S.p.A.
2. Ordine minimo € 250,00 netto merce.
3. Imballo standard gratuito.
4. Qualsiasi variazione delle presenti condizioni richiede la forma scritta.

### Diritto di Proprietà e Condizioni di Pagamento

1. La merce fornita rimane di proprietà di Sambonet Paderno Industrie S.p.A. fino all'integrale pagamento della fattura da parte del cliente.
2. Il pagamento della fattura è dovuto entro il termine di pagamento preventivamente concordato tra le parti. Allo scadere di tale termine, saranno dovuti gli interessi di mora al saggio di cui all'art.5 D.LGS. 231/2002 e succ. modifiche come da D.LGS. 192/2012, maggiorato dell'8%.

### Offerte/Ordini

1. Le offerte di Sambonet Paderno Industrie S.p.A. sono libere e non vincolanti all'ordine.
2. Con l'accettazione dell'offerta in forma scritta o della conferma d'ordine (con le modalità in essa contenute), si genera a tutti gli effetti un ordine che comporta l'esecuzione di un contratto conforme alle condizioni generali e termini di vendita.

### Resi/Reclami

1. La merce deve essere controllata al ricevimento.
2. In caso di colli difettosi/danneggiati, il documento di trasporto dovrà essere firmato con riserva, specificando i motivi (vale come prova la foto del collo con evidenza del segnacollo e nastro del corriere e descrizione del difetto).
3. I reclami saranno accettati entro **15 giorni** dalla data fattura, termine ultimo non negoziabile, alle seguenti condizioni:
  - a) la segnalazione di reclamo / richiesta di reso merce deve essere fatta attraverso la procedura guidata all'indirizzo [www.agenti.sambonet.it](http://www.agenti.sambonet.it) nell'area utente;
  - b) la merce dovrà essere resa franco nostra fabbrica;
  - c) In caso di responsabilità del cliente, Sambonet Paderno Industrie S.p.A. provvederà all'addebito del 15% del prezzo netto, con un minimo di € 25,00, per costi di gestione;
  - d) in caso di accertata responsabilità di Sambonet Paderno Industrie S.p.A., la merce verrà sostituita, e resa franco domicilio cliente;
  - e) per prodotti resi per riparazione non in garanzia, le spese di spedizione e rispeditura, sono a carico del cliente;
  - f) Non saranno accettati resi per articoli speciali (non a catalogo), incisi Tailor Made, con altre personalizzazioni o fuori produzione.

### Annullamento dell'ordine

1. Per i prodotti fuori catalogo, personalizzati o speciali NON è possibile annullare l'ordine.
2. Per i prodotti a catalogo, l'annullamento è possibile solo se l'ordine non è ancora stato confermato.

### Condizioni di Resa Italia

1. La merce è resa franco domicilio Cliente tramite corriere convenzionato con Sambonet Paderno Industrie S.p.A.:
  - a) con addebito forfettario di € 15,00 (spese di gestione ordine) per ordini da € 250,00 a € 500,00 netto merce;
  - b) senza alcun addebito per ordini superiori a € 500,00 netto merce.
2. Qualora il Cliente richieda che le spedizioni vengano effettuate tramite Suo corriere di fiducia, le merci verranno inoltrate automaticamente in **franco fabbrica**:
  - a) con addebito forfettario di € 15,00 (spese di gestione ordine) per ordini da € 250,00 a € 500,00 netto merce;
  - b) senza alcun addebito per ordini superiori a € 500,00 netto merce.
3. Per ogni contestazione o controversia è applicabile la legge Italiana e competente il Foro di Novara.

### Condizioni di Resa nei seguenti Paesi UE (isole escluse):

- Belgio, Olanda, Lussemburgo, Francia, Spagna, Germania**
1. La merce è resa **franco fabbrica** per ordini inferiori a € 500,00;
  2. La merce è resa **franco domicilio Cliente**:
    - a) con addebito di € 60,00 per ordini da € 500,00 a € 1.000,00 netto merce;
    - b) senza alcun addebito per ordini superiori a € 1.000,00 netto merce.
  3. Le condizioni sopra indicate sono valide solo per spedizioni tramite corriere convenzionato con Sambonet Paderno Industrie S.p.A.

### Condizioni di Resa nei restanti Paesi UE (isole escluse):

1. La merce è resa franco fabbrica per ordini inferiori a € 500,00;
2. La merce è resa franco domicilio Cliente:
  - a) con addebito di € 60,00 per ordini da € 500,00 a € 1.500,00 netto merce;
  - b) senza alcun addebito per ordini superiori a € 1.500,00 netto merce.
3. Le condizioni sopra indicate sono valide solo per spedizioni tramite corriere convenzionato con Sambonet Paderno Industrie S.p.A.

### Condizioni di Resa Paesi extra-UE

1. La merce è resa franco fabbrica.

### Personalizzazioni (I costi indicati sono da intendersi netti)

1. Sambonet Paderno Industrie S.p.A. effettua su richiesta del Cliente personalizzazioni ed esecuzioni particolari alle seguenti condizioni:
  - a) versamento di **acconto del 30%** sul valore dell'ordine;
  - b) consegna da convenire dopo l'approvazione disegno esecutivo e/o campione;
  - c) Sambonet Paderno Industrie S.p.A. si riserva la facoltà di applicare, per ogni singolo articolo, una **tolleranza pari a +/- 10%**, con arrotondamento all'unità superiore, nella spedizione dei quantitativi ordinati;
  - d) Sambonet Paderno Industrie S.p.A. provvederà a fornire al Cliente una scheda con l'indicazione di tutti i parametri necessari (disegno, posizione, dimensioni, ecc.) e procederà alla fornitura solo al ricevimento della stessa firmata per accettazione.
2. Seghettatura lame coltelli frutta: ove non prevista di serie, con addebito di € 0,65 al pezzo.
3. Incisione al Pantografo/Laser:
  - a) costo impianto: € 70,00;
  - b) costo incisione: posateria € 0,50 al pezzo - vasellame, incisione ove possibile, € 1,00 al pezzo;
  - c) quantità minime: posateria 100 pezzi per articolo - vasellame 10 pezzi per articolo.
4. Punzonatura:
  - a) costo punzoni: il primo punzone € 300,00 - i successivi € 150,00 cad.;
  - b) costo punzonatura: posateria € 0,50 al pezzo - vasellame preventivo su richiesta;
  - c) quantità minime:
    - nuovi impianti: posateria 1.000 pezzi per articolo - coltelli manico cavo 800 pezzi per articolo;
    - riordini: posateria 100 pezzi per articolo - coltelli manico cavo 800 pezzi per articolo.

### Personalizzazioni Sambonet Tailor Made (I costi indicati sono da intendersi netti)

1. Tipologia di incisioni Tailor Made standard:
  - a) Sul terminale frontale: uno dei loghi standard, oppure il monogramma (due lettere) utilizzando uno dei caratteri standard;
  - b) Sul terminale posteriore: la data in formato standard, utilizzando uno dei caratteri standard;
2. Costo di incisione Tailor Made:
  - a) € 19,90 per incisioni sul terminale frontale;
  - b) € 19,90 per incisioni sul terminale posteriore;
  - c) € 39,80 per incisioni sul terminale frontale e sul terminale posteriore.
3. Ordine minimo di acquisto per articoli sfusi Tailor Made:
  - a) 6 pz per le referenze realizzate in alpaca, a multipli di 6 pz;
  - b) 12 pz per tutte le altre referenze, a multipli di 12 pz;
4. Applicazione del costo di incisione Tailor Made sul singolo ordine di acquisto:
  - a) Un solo costo per ogni tipologia di incisione - indicate al punto 2;
  - b) Un solo costo a prescindere dal numero di referenze - se superiori al minimo di acquisto indicato al punto 3;
  - c) Un solo costo a prescindere dal numero di pz fino a 150 pz.
  - d) Oltre i 150 pz e a multipli di 150 pz verrà nuovamente applicato il costo di incisione.

### Condizioni speciali per le personalizzazioni

1. L'Azienda si riserva il diritto di non eseguire la personalizzazione qualora tecnicamente non eseguibile.
2. Ordini personalizzati e/o esecuzioni particolari non possono essere annullati.
3. I prodotti personalizzati non possono essere resi per sostituzione.
4. Le richieste di imballaggi specifici saranno a carico del Cliente.

### Commercializzazione

1. La merce è destinata alla commercializzazione nel Paese in cui ha sede il Cliente. Qualora la merce sia commercializzata in un Paese differente, sarà onere del Cliente verificare le normative applicabili in tale Paese incluse le normative doganali e di importazione, nonché il rischio di contestazioni da parte di terzi a qualunque titolo, restando inteso che Sambonet Paderno Industrie S.p.A. sarà manlevata e tenuta indenne dal Cliente per quanto causato dalla vendita della merce in tale diverso Paese.
2. Sambonet Paderno Industrie S.p.A. non fornisce alcuna garanzia in ordine a possibili contestazioni di violazione di diritti di proprietà industriale ed intellettuale di terzi, in particolare nell'ipotesi di rivendita della merce a mezzo Internet.
3. È vietato pubblicare prezzi inferiori ai listini vigenti in siti web senza autenticazione.

### Riserva di proprietà e condizioni di pagamento

1. Eventuali reclami non potranno in alcun caso avere come effetto il differimento o la sospensione dei pagamenti.
2. Il Cliente in situazioni di ritardo di pagamento sarà peraltro debitore di diritto, nei confronti di Sambonet Paderno Industrie S.p.A. di un indennizzo forfettario per spese di sollecito pari a € 40,00. Qualora le spese di sollecito siano superiori al suddetto importo, Sambonet Paderno Industrie S.p.A. avrà il diritto di richiedere un ulteriore indennizzo.
3. In caso di mancato pagamento di tutta o parte della fattura, o di aggravio della situazione finanziaria del Cliente, Sambonet Paderno Industrie S.p.A. avrà anche la facoltà di:
  - a) sospendere o annullare gli ordini e le consegne in corso;
  - b) esigere un pagamento anticipato per gli ulteriori ordini e/o garanzie di pagamento.

### Consegna

1. Le scadenze di consegna sono indicate il più esattamente possibile, ma dipendono dalle condizioni di approvvigionamento e trasporto di Sambonet Paderno Industrie S.p.A., la quale si impegna a porre la massima diligenza ai fini del rispetto delle consegne salvo cause di forza maggiore.
2. Il superamento dei tempi di consegna previsti, non potrà vincolare Sambonet Paderno Industrie S.p.A. al versamento di penalità, risarcimenti per danni e interessi.
3. Qualsiasi modifica di ordine darà luogo a una conseguente modifica della data di consegna.
4. Sono considerate come cause di forza maggiore, che svincolano Sambonet Paderno Industrie S.p.A. dall'obbligo di consegna: guerra, rivolta, incendio, scioperi, impossibilità di approvvigionamento, incidenti particolarmente rilevanti all'attrezzatura, la rottura di macchine, l'interruzione o il ritardo nel trasporto.
5. Sambonet Paderno Industrie S.p.A. terrà il Cliente tempestivamente informato di qualsiasi ritardo. In ogni caso, la consegna entro i termini potrà essere effettuata soltanto se il Cliente avrà puntualmente ottemperato a tutti i suoi obblighi nei confronti di Sambonet Paderno Industrie S.p.A., qualsiasi sia la causa.
6. Viene peraltro convenuto tra le parti che se il Cliente non prenderà possesso dei prodotti ordinati alle condizioni stabilite, Sambonet Paderno Industrie S.p.A. fatturerà al Cliente:
  - a) qualsiasi ulteriore spesa di trasporto e/o giacenza;
  - b) spese di custodia equivalenti al 5% dell'importo dell'ordine, tasse escluse, per ogni mese di ritardo.

### Avvertenze importanti

1. In considerazione del fatto che la produzione è artigianale, potrebbero rilevarsi lievi differenze tra partite diverse dello stesso prodotto.
2. I prodotti sottoposti a lavorazione PVD potrebbero essere soggetti a leggere variazioni cromatiche e di tonalità tra diversi modelli o tra le diverse referenze. Tali variazioni non sono da considerarsi difetti poiché compresi entro limiti di tolleranza prestabiliti e strettamente monitorati.
3. In fase di stampa sono possibili errori e/o omissioni. Sambonet Paderno Industrie S.p.A. si riserva il diritto di rettifica di eventuali errori di stampa o calcolo.
4. Le immagini, le caratteristiche e le misure espresse sono indicative e soggette a variazioni senza preavviso.
5. Le sagome delle posate illustrate di questa pubblicazione sono puramente indicative e non si riferiscono alle sagome reali.

### COPYRIGHT

© Ogni riproduzione anche parziale del presente catalogo è vietata se non espressamente autorizzata per iscritto da Sambonet Paderno Industrie S.p.A.

## Allgemeine Verkaufsbedingungen

- Bestellungen sind erst nach Bestätigung durch Sambonet Paderno Industrie S.p.A. gültig.
- Mindestwarenbestellwert € 250,00 netto.**
- Standardverpackung kostenlos.
- Änderungen dieser Bedingungen bedürfen der Schriftform.

## Eigentumsrecht und Zahlungsbedingungen

- Die gelieferte Ware bleibt bis zur vollständigen Bezahlung der Rechnung durch den Kunden Eigentum der Sambonet Paderno Industrie S.p.A.
- Die Bezahlung der Rechnung muss innerhalb der zwischen den Parteien zuvor vereinbarten Zahlungsfrist erfolgen. Nach Ablauf dieser Frist werden Verzugszinsen in der in Art. 5 der [italienischen gesetzesvertretenden Verordnung] D. Lgs. 231/2002 (in der durch D. Lgs. 192/2012 geänderten Fassung) vorgesehenen Höhe zuzüglich 8 % fällig.

## Angebote/Bestellungen

- Angebote von Sambonet Paderno Industrie S.p.A. sind freibleibend.
- Mit der schriftlichen Annahme des Angebots oder der Auftragsbestätigung (mit allen enthaltenen Bedingungen) wird eine in jeder Hinsicht wirksame Bestellung aufgegeben, die mit der Ausführung eines Vertrags gemäß den allgemeinen Verkaufsbedingungen verbunden ist.

## Rückgaben/Reklamationen

- Die Ware ist bei Erhalt zu kontrollieren.
- Sollten Pakete defekt/beschädigt sein, so ist das Transportdokument unter Vorbehalt und mit Angabe der Gründe (z. B. ein Foto der Ware, auf der die Kennzeichnung der Ware und die Spedition erkennbar sind, und eine Beschreibung des Defekts) zu unterschreiben.

Reklamationen werden innerhalb von 15 Tagen nach Rechnungsdatum als letzte nicht verhandelbare Frist unter folgenden Bedingungen angenommen:

- Die Reklamation/der Antrag auf Rücknahme der Ware erfolgt über das angeleitete Verfahren im Benutzerbereich der Website [www.agenti.sambonet.it](http://www.agenti.sambonet.it);
- Die Lieferung erfolgt frei unserem Werk;
- Liegt die Verantwortung für die Rückgabe beim Kunden, Sambonet Paderno Industrie S.p.A. stellt 15% des Nettopreises, jedoch mindestens € 25,00 als Bearbeitungskosten in Rechnung;
- Liegt die Verantwortung nachgewiesenermaßen bei Sambonet Paderno Industrie S.p.A., wird die Ware ersetzt und dem Kunden frei Haus zugestellt;
- Im Falle von Produkten, die zur Reparatur zurückgegeben werden und keiner Gewährleistung unterliegen, gehen die Kosten für Zu- und Rücksendung zu Lasten des Kunden;
- Nicht angenommen werden Rücksendungen von Sonderartikeln (nicht im Katalog), kundenindividuellen Artikeln und Artikeln, deren Produktion eingestellt wurde.

## Stornierung der Bestellung

- Bestellungen von Produkten, die nicht im Katalog enthalten oder die kundenindividuell gefertigt sind, oder Bestellungen von Sonderartikeln können NICHT storniert werden.
- Bei Produkten aus dem Katalog ist eine Stornierung nur möglich, wenn die Bestellung noch nicht bestätigt wurde.

## Lieferbedingungen für die folgenden EU-Länder (Inseln ausgeschlossen):

### Belgien, Niederlande, Luxemburg, Frankreich, Spanien, Deutschland

- Die Lieferung der Ware erfolgt frei Werk bei Bestellungen unter einem Wert von € 500,00.
- Die Lieferung zum Kunden erfolgt frei Haus, wobei:
  - bei einem Warenbestellwert zwischen € 500,00 und € 1.000,00 netto eine Pauschale von € 60,00 in Rechnung gestellt wird;
  - bei einem Warenbestellwert von über € 1.000,00 netto keine Versandkosten in Rechnung gestellt werden.
- Die vorstehenden Bedingungen gelten nur für den Versand mit dem Vertragsspediteur von Sambonet Paderno Industrie S.p.A.

## Lieferbedingungen für die übrigen EU-Länder (Inseln ausgeschlossen)

- Die Lieferung der Ware erfolgt **frei Werk** bei Bestellungen unter einem Wert von € 500,00.
- Die Lieferung **zum Kunden** erfolgt **frei Haus**, wobei:
  - bei einem Warenbestellwert zwischen € 500,00 und € 1.500,00 netto eine Pauschale von € 60,00 in Rechnung gestellt wird;
  - bei einem Warenbestellwert von über € 1.500,00 netto keine Versandkosten in Rechnung gestellt werden.
- Die vorstehenden Bedingungen gelten nur für den Versand mit dem Vertragsspediteur von Sambonet Paderno Industrie S.p.A.

## Lieferbedingungen für Länder außerhalb der EU

- Die Lieferung erfolgt frei Werk.

## Kundenindividuelle Anfertigungen (die angegebenen Kosten verstehen sich als Nettobeträge)

- Auf Wunsch des Kunden stellt Sambonet Paderno Industrie S.p.A. kundenindividuelle und Sonderanfertigungen her. Es gelten die folgenden Bedingungen:
  - Es wird eine **Anzahlung in Höhe von 30 %** des Bestellwertes geleistet;
  - Die Lieferung wird nach der Freigabe der endgültigen Gestaltung und/oder des Musters vereinbart;
  - Sambonet Paderno Industrie S.p.A. behält sich in Bezug auf den Versand der bestellten Mengen für jeden einzelnen Artikel einen **Toleranzwert** von +/- 10 % mit Aufrundung auf die nächsthöhere Einheit vor;
  - Sambonet Paderno Industrie S.p.A. legt dem Kunden ein Beschreibungsblatt mit allen erforderlichen Parametern (Zeichnung, Platzierung, Abmessungen usw.) vor. Die Lieferung erfolgt erst, nachdem der Kunde dieses zum Zeichen der Annahme unterschrieben und zurückgesendet hat.
- Wellenschliff Obstmesser, wenn nicht serienmäßig vorgesehen, Aufpreis von € 0,65 pro Stück.
- Gravur mit Pantograf/Laser
  - Einrichtungskosten: € 70,00;
  - Gravurkosten: Besteck € 0,50 pro Stück – Geschirr, sofern Gravur möglich, € 1,00 pro Stück;
  - Mindestmengen: Besteck 100 Stück je Artikel – Geschirr 10 Stück je Artikel.
- Stanzungen:
  - Punzen: erste Punze € 300,00 – jede weitere € 150,00;
  - Stanzkosten: Besteck € 0,50 pro Stück – Geschirr: bitte Kostenvoranschlag anfordern;
  - Mindestmengen:
    - Erstbestellung: Besteck 1.000 Stück je Artikel – Messer mit Hohlheftgriff 800 Stück je Artikel;
    - Folgebestellungen: Besteck 100 Stück je Artikel – Messer mit Hohlheftgriff 800 Stück je Artikel.

## Personalisierungen Sambonet Tailor Made (die angegebenen Beträge sind Nettobeträge)

- Arten Standardgravuren Tailor-Made:
  - Auf dem vorderen Ende des Besteckgriffs: eines der Standardlogos, oder das Monogramm (zwei Buchstaben) mit Standardschriftarten;
  - Auf dem hinteren Ende des Besteckgriffs: Datum im Standardformat, mit einer Standardschriftart;
- Kosten der Gravur Tailor-Made:
  - € 19,90 für Gravuren auf dem Ende des Besteckgriffs / Vorderseite;
  - € 19,90 für Gravuren auf dem Ende des Besteckgriffs / Hinterseite;
  - € 39,80 für Gravuren auf dem Ende des Besteckgriffs / Vorder- und Hinterseite.
- Mindestbestellung für lose Artikel Tailor-Made:
  - 6 St. für die Bezugsprofile in Alpacca, in Vielfachstückelungen von 6 St.;
  - 12 St. für alle anderen Bezugsprofile, in Vielfachstückelungen von 12 St.;
- Anwendung der Preise für die Gravur Tailor-Made auf die einzelne Bestellung:
  - Nur einmalige Zahlung für jede Art von Gravur – wie in Punkt 2 angeführt;
  - Nur einmalige Zahlung unabhängig von der Zahl der Artikel – bei Überschreitung der Mindestbestellung wie in Punkt 3 angeführt;
  - Nur einmalige Zahlung unabhängig von der Stückzahl bis zu 150 St.
  - Bei mehr als 150 St. und Vielfachen von 150 St. werden die Kosten für die Gravur erneut veranschlagt.

## Sonderkonditionen für Personalisierungen

- Die Firma behält sich das Recht vor die Personalisierung nicht auszuführen, wenn diese technisch nicht durchführbar ist.
- Bestellungen von kundenindividuellen und/oder nicht standardmäßigen Sonderanfertigungen können nicht storniert werden.
- Kundenindividuell gefertigte Artikel können nicht umgetauscht werden.
- Besondere Verpackungsanfragen gehen zu Lasten des Kunden.

## Vertrieb

- Die Ware ist für die Vermarktung in dem Land, in dem der Kunde ansässig ist, bestimmt. Wenn die Ware in einem anderen Land vermarktet wird, liegt es in der Verantwortung des Kunden, die in diesem Land geltenden Vorschriften einschließlich Zoll- und Einfuhrbestimmungen sowie das Risiko von Streitigkeiten durch Dritte aus irgendeinem Grund zu überprüfen. Es versteht sich, dass Sambonet Paderno Industrie S.p.A. für jede mögliche Streitigkeit, die durch den Verkauf der Ware in diesem anderen Land entstehen kann, schadlos gehalten wird.
- Sambonet Paderno Industrie S.p.A. übernimmt keine Garantie für eventuelle Ansprüche wegen Verletzung von gewerblichen Schutzrechten und Rechten des geistigen Eigentums Dritter, insbesondere im Falle des Weiterverkaufs der Ware über Internet.
- Die Veröffentlichung von Preisen, die unter denen der geltenden Preislisten liegen, ist auf Webseiten ohne Authentifizierung verboten.

## Eigentumsvorbehalt und Zahlungskonditionen

- Eventuelle Beanstandungen können in keinem Fall den Aufschub oder die Unterbrechung der Zahlungen zur Folge haben.
- Bei Zahlungsverzögerungen ist der Kunde im Übrigen gegenüber Sambonet Paderno Industrie S.p.A. rechtmäßiger Schuldner einer pauschalen Erstattung für Mahnaufwendungen, die sich auf € 40,00 beläuft. Wenn die Mahnaufwendungen den oben genannten Betrag überschreiten, hat Sambonet Paderno Industrie S.p.A. das Recht eine weitere Erstattung einzufordern.
- Im Falle der Nichtzahlung des vollständigen oder teilweisen Rechnungsbetrags oder einer Verschlechterung der finanziellen Lage des Kunden hat Sambonet Paderno Industrie S.p.A. auch die Befugnis:
  - laufende Bestellungen und Lieferungen zu unterbrechen oder zu annullieren;
  - eine Vorauszahlung für weitere Bestellungen und/oder Zahlungsverpflichtungen zu verlangen.

## Lieferung

- Die Liefertermine sind so genau wie möglich angegeben, hängen aber von den Materialbeschaffungs- und Transportbedingungen ab. Sambonet Paderno Industrie S.p.A. bemüht sich aufs Äußerste die Auslieferungstermine einzuhalten. Ausgenommen davon sind Fälle von höherer Gewalt.
- Die Überschreitung der vorgesehenen Lieferzeiten verpflichtet Sambonet Paderno Industrie S.p.A. nicht zur Zahlung von Straf-, Schadensersatz- und Zinszahlungen.
- Jede Änderung einer Bestellung hat eine Änderung des Liefertermins zur Folge.
- Als Fälle von höherer Gewalt und somit als Bedingungen, die Sambonet Paderno Industrie S.p.A. von der Lieferpflicht entbinden, gelten: Krieg, Aufruhr, Brand, Streiks, Unmöglichkeit der Materialbeschaffung, erhebliche Unfälle an den Geräten, der Bruch einer Maschine, die Unterbrechung oder Verspätung des Transports.
- Sambonet Paderno Industrie S.p.A. informiert den Kunden rechtzeitig über jede Art von Verspätung. In jedem Fall kann die vereinbarte Lieferung nur erfolgen wenn der Kunde alle seine Verpflichtungen gegenüber Sambonet Paderno Industrie S.p.A. pünktlich erfüllt hat und zwar aus welchem Grund auch immer.
- Darüberhinaus wird zwischen den Parteien vereinbart, dass, wenn der Kunde die bestellten Produkte nicht zu den festgelegten Konditionen entgegen nimmt, Sambonet Paderno Industrie S.p.A. dem Kunden:
  - jede weitere Ausgabe für Transport und/oder Einlagerung;
  - Aufbewahrungskosten in Höhe von 5% des Betrags der Bestellung, ausschließlich Steuer, für jeden Monat Verspätung in Rechnung stellt.

## Wichtige Hinweise

- Da verschiedene Bearbeitungsschritte handwerksmäßig ausgeführt werden, könnten leichte Abweichungen bei unterschiedlichen Warenpartien des selben Produktes auftreten.
- Die Produkte, die mit PVD-Verfahren hergestellt werden, können leichte chromatische Variationen und Farbtöne je nach den verschiedenen Modellen und Bezugsprofilen aufweisen. Diese Variationen sind nicht als Fehler anzusehen, da sie sich innerhalb der vorgesehenen Toleranzwerte bewegen und sorgfältig überwacht werden.
- Beim Druck kann es zu Fehlern und/oder Auslassungen kommen. Sambonet Paderno Industrie S.p.A. behält sich die Korrektur von Druck- oder Rechenfehlern vor.
- Fotos und Abmessungen sind nur als Information zu verstehen. Wir behalten uns das Recht vor, die angegebenen Spezifikationen jederzeit zu ändern.
- Das Profil der Bestecke ist nur als Informationskizze zu verstehen. Es stellt nicht dar die wirklichen Profile.

## COPYRIGHT

© Die Vielfältigkeit dieses Katalogs -auch wenn partial- ohne unsere ausdrückliche schriftliche Erlaubnis ist untersagt.

## FRA

### Termes et conditions générales de vente

1. Toute commande est soumise à l'acceptation de Sambonet Paderno Industrie S.p.A.
2. Le montant minimum de commande est de € 250,00 net HT.
3. Emballage standard gratuit.
4. Toute modification de ces conditions doit se faire par écrit.

### Droit de propriété et conditions de paiement

1. Les marchandises fournies restent la propriété de Sambonet Paderno Industrie S.p.A. jusqu'au paiement intégral de la facture par le client.
2. La facture doit être réglée dans le délai préalablement convenu entre les parties. Tout retard de paiement entraînera l'application d'intérêts calculés au taux fixé par l'article 5 du décret législatif italien 231/2002 tel que modifié par le décret législatif italien 192/2012, majoré de 8%.

### Offres/ Commandes

1. Les offres de Sambonet Paderno Industrie S.p.A. sont libres et n'engagent pas à passer une commande.
2. L'acceptation d'une offre par écrit, ou la confirmation de la commande (et les manières qui sont contenu), sera réputée une véritable commande, qui entraîne l'exécution d'un contrat conforme aux termes et aux conditions générales de vente.

### Retours/Réclamations

1. Les marchandises doivent être contrôlées à la réception.
2. En cas de colis défectueux / endommagés, le document de transport devra être signé sous réserve, en spécifiant les raisons (la photo du colis avec l'étiquette logistique et le ruban du transporteur bien en évidence, accompagnée de la description du défaut, vaut réserve).
3. Les réclamations doivent être soumises dans un délai maximum non négociable de 15 jours à compter de la date de la facture, aux conditions suivantes:
  - a) la réclamation / la demande de retour de marchandises doit être soumise en suivant la procédure assistée disponible à l'adresse [www.agenti.sambonet.it](http://www.agenti.sambonet.it) dans l'espace utilisateur;
  - b) Tous les retours de marchandises sont départ notre usine;
  - c) en cas de responsabilité du client, Sambonet Paderno Industrie S.p.A. facturera 15% du prix net, avec un montant minimum de € 25,00, pour les frais de gestion;
  - d) en cas de responsabilité avérée de Sambonet Paderno Industrie S.p.A., les marchandises seront remplacées et retournées franco domicile client;
  - e) pour les produits retournés pour réparation hors garantie, les frais de transport aller-retour sont à la charge du client;
  - f) les retours d'articles spéciaux (hors catalogue), personnalisés ou hors production ne sont pas acceptés.

### Annulation des commandes

1. Les commandes de produits hors catalogue, personnalisés ou spéciaux ne peuvent pas être annulées.
2. Les commandes de produits sur catalogue ne peuvent être annulées que si la commande n'a pas encore été confirmée.

### Conditions de livraison pour les suivants Pays de l'UE (îles exclues) :

#### Belgique, Pays Bas, Luxembourg, France, Espagne, Allemagne

1. Les envois de marchandises sont **départ usine** pour tout montant de commande inférieur à € 500,00.
2. Les envois de marchandises sont **franco domicile client**:
  - a) avec € 60,00 à la charge du client pour tout montant net HT de commande de € 500,00 à € 1.000,00;
  - b) sans aucune charge pour tout montant net HT de commande supérieur à € 1.000,00.
3. Les conditions susmentionnées ne sont valables que pour les envois effectués par le transporteur conventionné avec Sambonet Paderno Industrie S.p.A.

### Conditions de livraison pour les autres Pays de l'UE (îles exclues)

1. Les envois de marchandises sont **départ usine** pour tout montant de commande inférieur à € 500,00.
2. Les envois de marchandises sont **franco domicile client**:
  - a) avec € 60,00 à la charge du client pour tout montant net HT de commande de € 500,00 à € 1.500,00;
  - b) sans aucune charge pour tout montant net HT de commande supérieur à € 1.500,00.
3. Les conditions susmentionnées ne sont valables que pour les envois effectués par le transporteur conventionné avec Sambonet Paderno Industrie S.p.A.

### Conditions de livraison pour les Pays n'appartenant pas à l'UE

1. Tous les envois de marchandises sont départ usine.

### Produits personnalisés (les prix indiqués sont nets)

1. Sambonet Paderno Industrie S.p.A. est en mesure de réaliser des produits personnalisés à la demande du client aux conditions suivantes:
  - a) paiement d'un **acompte de 30%** sur le montant de la commande;
  - b) livraison à convenir après l'approbation du dessin exécutif et/ou de l'échantillon;
  - c) Sambonet Paderno Industrie S.p.A. se réserve le droit d'appliquer à chaque référence une **tolérance** de livraison sur les quantités commandées de +/- 10% arrondie à l'unité supérieure;
  - d) Sambonet Paderno Industrie S.p.A. enverra au client une fiche avec toutes les données techniques nécessaires (dessin, position, dimensions, etc.) et n'exécutera la commande qu'à la réception de la fiche signée pour autorisation.
2. Couteaux à dessert exécutés avec lame dentelée (si cette lame n'est pas la lame standard): € 0,65 par pièce.
3. Gravure pantographe/laser:
  - a) frais de commande: € 70,00;
  - b) frais de gravure: couverts € 0,50 par pièce - plats et articles de table, si gravure faisable, € 1,00 par pièce;
  - c) quantité minimum de commande: couverts 100 pièces pour chaque référence - plats et articles de table 10 pièces pour chaque référence.
4. Poinçonnage:
  - a) frais de poinçon: € 300,00 pour le premier poinçon - € 150,00 pour chaque poinçon supplémentaire;
  - b) frais de poinçonnage: couverts € 0,50 par pièce - plats et articles de table: devis sur demande;
  - c) quantité minimum de commande:
    - première commande: couverts 1.000 pièces par référence - couteaux poignée creuse 800 pièces par référence;
    - commandes suivantes: couverts 100 pièces par référence - couteaux poignée creuse 800 pièces par référence.

### Personnalisations Sambonet Tailor Made (Les prix indiqués sont nets)

1. Types de gravures Tailor Made standard :
  - a) Au recto du manche : un des logos standard ou un monogramme (deux lettres) en utilisant l'une des polices standard ;
  - b) Au verso du manche : la date au format standard en utilisant l'une des polices standard ;
2. Coût de la gravure Tailor Made :
  - a) 19,90 € pour les gravures au recto du manche ;
  - b) 19,90 € pour les gravures au verso du manche ;
  - c) 39,80 € pour les gravures au recto et au verso du manche.
3. Minimum d'achat pour des articles en vrac Tailor Made :
  - a) 6 pièces pour les références en maillechort, par multiple de 6 pièces ;
  - b) 12 pièces pour toutes les autres références, par multiple de 12 pièces ;
4. Application du coût de la gravure Tailor Made sur chaque commande :
  - a) Un coût unique pour chaque type de gravure - indiqués au point 2 ;
  - b) Un coût unique quel que soit le nombre de références - à condition qu'il soit supérieur au minimum d'achat indiqué au point 3 ;
  - c) Un coût unique quel que soit le nombre de pièces jusqu'à 150 pièces.
  - d) Au-delà de 150 pièces et par multiple de 150 pièces, le coût de la gravure sera à nouveau appliqué.

### Conditions spéciales pour les personnalisations

1. L'Entreprise se réserve le droit de ne pas procéder à la personnalisation pour des raisons de faisabilité technique.
2. Les commandes de produits personnalisés e/o spéciaux ne peuvent pas être annulées.
3. Les produits personnalisés ne peuvent pas être retournés pour remplacement.
4. Toute demande d'emballage spécifique est à la charge du Client.

### Commercialisation

1. Les produits sont destinés à la commercialisation dans le Pays où le client est basé. Si les produits sont vendus dans un autre Pays, il est de la responsabilité du client de vérifier les réglementations applicables dans ce Pays, y compris les réglementations douanières et d'importation, ainsi que le risque de litiges par des tiers pour quelque motif que ce soit, étant entendu que Sambonet Paderno Industrie S.p.A. sera déchargé de tout litige qui pourrait survenir dans ce Pays différent.
2. Sambonet Paderno Industrie S.p.A. ne fournit aucune garantie quant à d'éventuelles actions pour violation des droits de propriété industrielle et intellectuelle par des tiers, en particulier en cas de revente du produit sur Internet.
3. Il est interdit de publier des prix inférieurs aux tarifs en vigueur sur des sites Web sans authentification.

### Réserve de propriété et conditions de paiement

1. Toute réclamation du Client ne peut en aucun cas avoir pour effet de différer ou de suspendre le paiement.
2. En cas de retard de paiement, le Client est redevable de plein droit, envers Sambonet Paderno Industrie S.p.A., d'une indemnité forfaitaire de 40,00 € pour frais de recouvrement. Si les frais de recouvrement sont supérieurs à ce montant, Sambonet Paderno Industrie S.p.A. est en droit de réclamer une indemnisation complémentaire.
3. En cas de non-paiement de tout ou partie de la facture, ou en cas de dégradation de la situation financière du Client, Sambonet Paderno Industrie S.p.A. a également le droit de :
  - a) suspendre ou annuler toute commande et livraison en cours ;
  - b) exiger un acompte pour toute nouvelle commande et/ou des garanties de paiement.

### Livraison

1. Les délais de livraison sont indiqués aussi exactement que possible, mais sont fonction des possibilités d'approvisionnement et de transport de Sambonet Paderno Industrie S.p.A., qui s'engage à respecter les délais de livraison avec la plus grande rigueur sauf cas de force majeure.
2. Les dépassements de délai de livraison ne peuvent donner lieu au paiement de pénalités et de dommages-intérêts par Sambonet Paderno Industrie S.p.A.
3. Toute modification de la commande entraînera une modification de la date de livraison.
4. Son considérés comme cas de force majeure déchargeant Sambonet Paderno Industrie S.p.A. de son obligation de livrer : la guerre, l'émeute, l'incendie, les grèves, l'impossibilité d'être approvisionné, les accidents graves de matériel, les pannes de machines, l'interruption ou le retard dans les transports.
5. Sambonet Paderno Industrie S.p.A. s'engage à informer le Client sans délai de tout retard. En toute hypothèse, la livraison dans les délais ne peut intervenir que si le Client est à jour de ses obligations envers Sambonet Paderno Industrie S.p.A., quelle qu'en soit la cause.
6. Les parties conviennent également que si le Client ne prend pas possession des produits commandés selon les conditions fixées, Sambonet Paderno Industrie S.p.A. lui facturera :
  - a) les frais supplémentaires de transport et/ou de stockage ;
  - b) les frais de garde équivalents à 5 % du montant de la commande, hors taxes, pour chaque mois de retard.

### Avertissements importants

1. Car différents cycles de production sont effectués artisanalement, on pourrait remarquer des légères différences entre différents lots du même produit.
2. Les produits soumis à un traitement PVD peuvent présenter de légères variations de couleurs et de teintes entre les différents modèles ou entre les différentes références. Ces variations ne doivent pas être considérées comme des défauts car elles se situent dans des limites de tolérance définies et font l'objet d'un contrôle strict.
3. Des fautes et/ou des omissions peuvent survenir lors de l'impression. Sambonet Paderno Industrie S.p.A. se réserve le droit de corriger toute faute d'impression ou de calcul.
4. Les photos et dimensions indiquées sont indicatives. Sambonet Paderno Industrie S.p.A. se réserve le droit de modifier à tout moment les spécifications techniques.
5. Les silhouettes des couverts de ce tarif sont uniquement indicatives et elles ne se réfèrent pas à la silhouette réelle des couverts.

### COPYRIGHT

© Toute reproduction ou reproduction partielle de ce catalogue est interdite sauf expressément autorisée par Sambonet Paderno Industrie S.p.A.



## Condiciones generales y de venta

1. Los pedidos deben ser aprobados por Sambonet Paderno Industrie S.p.A.
2. Pedido mínimo de **€ 250,00 en factura**.
3. Embalaje estándar incluido.
4. Cualquier variación de las presentes condiciones debe realizarse por escrito.

## Derecho de propiedad y condiciones de pago

1. La mercancía queda de propiedad de Sambonet Paderno Industrie S.p.A. hasta que el cliente realice el pago total de la factura.
2. El plazo de pago de la factura debe realizarse dentro de los términos establecidos previamente por las partes. Al caducar dicho plazo, deberán considerarse los intereses de demora según lo dispuesto por el art. 5 D.LGS 231/2002 y siguientes modificaciones, como previsto en el D.LGS. 192/2012, con aumento del 8%.

## Ofertas/Pedidos

1. Las ofertas de Sambonet Paderno Industrie S.p.A. son libres y no vinculantes al pedido.
2. Aceptando por escrito la oferta, o de la confirmación del pedido (con la modalidad en ella incluidas) se produce a todos los efectos un pedido que implica un contrato conforme a las condiciones generales y de venta.

## Restituciones/Reclamaciones

1. La mercancía debe controlarse en el momento de la entrega.
2. En caso de embalajes defectuosos/deteriorados, el documento de transporte se deberá firmar bajo reserva especificando las razones (como reserva se debe presentar la foto del embalaje y su código de barra, la cinta del servicio de transporte y la descripción de la avería).
3. Las reclamaciones se aceptarán dentro de **15 días** a partir de la fecha de emisión de la factura, plazo no negociable, bajo las condiciones que se citan a continuación:
  - a) La reclamación/solicitud de restitución de mercancía debe realizarse a través del procedimiento guiado en la página web: [www.agenti.sambonet.it](http://www.agenti.sambonet.it) en el área de usuarios;
  - b) La mercancía se entrega franco nuestra fábrica;
  - c) En caso de que el cliente sea responsable, Sambonet Paderno Industrie S.p.A. le cargará el 15% del precio neto, con un mínimo de € 25,00 de coste de gestión;
  - d) en caso de responsabilidad comprobada de Sambonet Paderno Industrie S.p.A., la mercancía será reemplazada y entregada al cliente con porte pagado;
  - e) los gastos de transporte para la reparación de productos sin garantía, corren a cargo del cliente;
  - f) para los artículos especiales (no incluidos en el catálogo), personalizados o fuera de producción no será posible restituir la mercancía.

## Cancelación del pedido

- a) para los productos no incluidos en el catálogo, personalizados o especiales NO es posible cancelar el pedido.
- b) para los productos incluidos en el catálogo, es posible cancelar el pedido sólo en caso de que aún no haya sido confirmado.

## Condiciones de entrega en los demás Países UE (islas excluidas)

### Bélgica, Holanda, Luxemburgo, Francia, España, Alemania

1. Los pedidos cuyo importe no alcance los € 500,00 se remiten **franco fábrica**.
2. La mercancía se remite a **porte pagado**:
  - a) cargando € 60,00 para pedidos de entre € 500,00 y € 1.000,00 netos;
  - b) sin cargo alguno si el pedido neto sobrepasa los € 1.000,00.
3. Las condiciones mencionadas arriba deben considerarse válidas sólo para los servicios de transporte elegidos por Sambonet Paderno Industrie S.p.A.

## Condiciones de entrega en los Países extra UE (islas excluidas)

1. Los pedidos cuyo importe no alcance los € 500,00 se remiten **franco fábrica**.
2. La mercancía se remite a **porte pagado**:
  - a) cargando € 60,00 para pedidos de entre € 500,00 y € 1.500,00 netos;
  - b) sin cargo alguno si el pedido neto sobrepasa los € 1.500,00.
3. Las condiciones mencionadas arriba deben considerarse válidas sólo para los servicios de transporte elegidos por Sambonet Paderno Industrie S.p.A.

## Condiciones de entrega en los Países extra UE

1. La mercancía se entrega **franco fábrica**.

## Personalizaciones (Los precios indicados deben considerarse netos)

1. Bajo solicitud del cliente, Sambonet Paderno Industrie S.p.A. realiza personalizaciones y acabados particulares según las siguientes condiciones:
  - a) **pago de un anticipo del 30%** del valor del pedido;
  - b) La entrega será establecida tras aprobar el diseño ejecutivo y/o la muestra;
  - c) Sambonet Paderno Industrie S.p.A. se reserva el derecho de aplicar, en cada artículo, una **tolerancia del +/- 10%**, redondeando por exceso, para el envío de las cantidades solicitadas;
  - d) Sambonet Paderno Industrie S.p.A. enviará al cliente una ficha con toda la información necesaria (diseño, posición, medidas, ecc). La entrega se efectuará sólo después de haber recibido la ficha firmada por el cliente.
2. Endentado de hojas cuchillos poste: si no previsto de serie, con cargo de € 0,65 / pieza.
3. Grabado por Pantógrafo/Láser:
  - a) coste instalación: € 70,00;
  - b) coste grabado: cubiertos € 0,50 / pieza – vajilla, grabado (si es posible) € 1,00 / pieza;
  - c) cantidades mínimas. Cubiertos: 100 piezas por modelo - vajilla: 10 piezas por modelo.
4. Punzonado:
  - a) coste punzones: € 300,00 para el primer punzón - € 150,00 para los siguientes (cada uno);
  - b) coste punzonado: cubiertos € 0,50 / pieza - vajilla: solicitando un presupuesto;
  - c) pedidos mínimos:
    - nuevas instalaciones. Cubiertos: 1.000 piezas por modelo - cuchillos de mango hueco: 800 piezas por modelo;
    - pedidos adicionales. Cubiertos: 100 piezas por modelo - cuchillos de mango hueco: 800 piezas por modelo.

## Personalizaciones Sambonet Tailor Made (Los costes indicados son netos)

1. Tipos de grabados Tailor Made estándar:
  - a) En el terminal frontal: uno de los logotipos estándar, o el monograma (dos letras) usando uno de los caracteres estándar;
  - b) En el terminal trasero: la fecha en formato estándar, utilizando uno de los caracteres estándar;
2. Coste de grabado Tailor Made:
  - a) € 19,90 para grabados en el terminal frontal;
  - b) € 19,90 para grabados en el terminal trasero;
  - c) € 39,80 para grabados en el terminal delantero y en el terminal trasero.
3. Pedido mínimo de compra para artículos sueltos Tailor Made:
  - a) 6 pzas para las referencias hechas en alpaca, con múltiples de 6 pzas;
  - b) 12 pzas para todas las otras referencias, con múltiples de 12 pzas;
4. Aplicación del coste de grabado Tailor Made en un único pedido de compra:
  - a) Un solo coste para cada tipo de grabado - indicados en el punto 2;
  - b) Un solo coste independientemente del número de referencias - si superiores al mínimo de compra indicado en el punto 3;
  - c) Un solo coste independientemente del número de pzas hasta 150 pzas.
  - d) Con más de 150 pzas y múltiples de 150 pzas se aplicará otra vez el coste de grabado.

## Condiciones especiales para las personalizaciones

1. La Empresa se reserva el derecho de no llevar a cabo la personalización si no fuera técnicamente realizable.
2. Pedidos personalizados y/o acabados particulares no se pueden cancelar.
3. No se pueden devolver, para su reemplazo, los productos personalizados.
4. Las solicitudes de embalajes específicos correrán a cargo del Cliente.

## Comercialización

1. Los productos están destinados a la comercialización en el País donde se encuentra el cliente. Si los productos se comercializan en un País diferente, será responsabilidad del cliente verificar las regulaciones aplicables en ese País, incluidas las regulaciones de aduanas e importación, así como el riesgo de disputas por parte de terceros por cualquier motivo, entendiéndose que Sambonet Paderno Industrie SpA estará libre de cualquier disputa que pueda surgir en este País diferente.
2. Sambonet Paderno Industrie S.p.A. no ofrece ninguna garantía con respecto a posibles reclamos de violación de derechos de propiedad industrial e intelectual de terceros, en particular en el caso de reventa de los productos a través de Internet.
3. Está prohibido publicar precios inferiores a las listas de precios vigentes en sitios web sin autenticación.

## Reserva de propiedad y condiciones de pago

1. Cualquier reclamación no podrá, en ningún caso, tener como efecto el retraso o la suspensión de los pagos.
2. Además, en situaciones de retraso en el pago, el Cliente será deudor de derecho, para con Sambonet Paderno Industrie S.p.A. de una indemnización a tanto alzado por los gastos de requerimiento igual a € 40,00. Si los gastos de requerimiento son más altos que la cantidad mencionada anteriormente, Sambonet Paderno Industrie S.p.A. tendrá derecho a solicitar una compensación adicional.
3. En caso de falta de pago de toda o parte de la factura, o de empeoramiento de la situación financiera del Cliente, Sambonet Paderno Industrie S.p.A. también tendrá el derecho de:
  - a) suspender o cancelar los pedidos y las entregas en curso;
  - b) exigir un pago por adelantado para los pedidos y/o garantías de pago sucesivos.

## Entrega

1. Los plazos de entrega se indican lo más exactamente posible, pero dependen de las condiciones de abastecimiento y transporte de Sambonet Paderno Industrie S.p.A., que se compromete a poner la máxima diligencia para cumplir con las entregas, excepto en casos de fuerza mayor.
2. Exceder los tiempos de entrega previstos no puede vincular Sambonet Paderno Industrie S.p.A. al pago de sanciones o indemnizaciones por daños e intereses.
3. Cualquier modificación del pedido dará lugar a una consecuente modificación de la fecha de entrega.
4. Se consideran causas de fuerza mayor que liberan Sambonet Paderno Industrie S.p.A. de la obligación de la entrega: guerra, revuelta, incendio, huelgas, imposibilidad de abastecimiento, accidentes especialmente relevantes al equipo de fabricación, la rotura de máquinas, la interrupción o el retraso en el transporte.
5. Sambonet Paderno Industrie S.p.A. informará al Cliente de forma tempestiva sobre cualquier retraso. En cualquier caso, la entrega dentro de los plazos solo se puede realizar si el Cliente ha cumplido debidamente con todas sus obligaciones para con Sambonet Paderno Industrie S.p.A., cualquiera sea la causa.
6. También se acuerda entre las partes que si el Cliente no toma posesión de los productos pedidos bajo las condiciones establecidas, Sambonet Paderno Industrie S.p.A. facturará al Cliente:
  - a) cualquier costo adicional de transporte y/o almacenamiento;
  - b) gastos de custodia equivalentes al 5% del monto del pedido, excluidos los impuestos, para cada mes de retraso.

## Advertencias importantes

1. Puesto que diferentes fases del mecanizado se efectúan con un cuidado artesanal, podrían manifestarse pequeñas diferencias entre distintos lotes del mismo artículo.
2. Los productos sujetos al procesamiento PVD pueden estar sujetos a ligeras variaciones de color y tono entre diferentes modelos o entre diferentes referencias. Estas variaciones no deben considerarse defectos, ya que están dentro de los límites de tolerancia preestablecidos y se controlan estrictamente.
3. Al imprimir puede que surjan errores y/o omisiones. Sambonet Paderno Industrie S.p.A. se reserva el derecho a rectificar eventuales errores de impresión o de cálculo.
4. Fotos, datos y medidas que aparecen en este catálogo son indicativos y susceptibles, sin previo aviso, de modificación.
5. Los perfiles de los cubiertos de la lista de precios son meramente simbólicos y no corresponden a los perfiles reales.

## COPYRIGHT

© Queda prohibida la reproducción total o parcial de este catálogo sin autorización de forma expresa y por escrito de Sambonet Paderno Industrie S.p.A.

**FOTO - PHOTO**

**Riccardo Bianchi**  
**Felice Scoccimarro**

**STAMPA - PRINT**

**Graphicscalve S.p.A.**

MEMBER  
OF 

**ARCTURUS GROUP**

**© COPYRIGHT**

- Ogni riproduzione anche parziale del presente catalogo è vietata se non espressamente autorizzata per iscritto da Sambonet Paderno Industrie S.p.A.
- This catalogue may not be reproduced in whole or in part unless specific prior written authorization of Sambonet Paderno Industrie S.p.A.
- Die Vervielfältigung dieses Katalogs -auch wenn partial- ohne unsere ausdrückliche schriftliche Erlaubnis ist untersagt.
- Toute reproduction ou reproduction partielle de ce catalogue est interdite sauf expressément autorisée par Sambonet Paderno Industrie S.p.A.
- Queda prohibida la reproducción total o parcial de este catálogo sin autorización de forma expresa y por escrito de Sambonet Paderno Industrie S.p.A.

**NOTE - NOTES**

- Le misure, caratteristiche ed illustrazioni dei prodotti sono indicative e soggette a variazioni senza preavviso qualora esigenze tecnico produttive lo richiedessero.
- The pictures illustrated and data are representatives. We reserve the right to alter at any time the specifications stated without notice, whenever technical requirements shall so demand.
- Fotos und Abmessungen sind nur als information zu verstehen. Wir behalten uns das Recht vor, die angegebenen Spezifikationen jederzeit zu ändern, sofern es aus produktionstechnischen Gründen erforderlich ist.
- Les photos et dimensions indiquées sont indicatives. Nous nous réservons le droit de modifier à tout moment les spécifications techniques, si la situation l'exige.
- Fotos, datos y medidas que aparecen en este catálogo son indicativos y susceptibles, sin previo aviso, de modificación por exigencias técnicas o de producción.



# PADERNO<sup>®</sup>

## WORLD CUISINE

PARTNER OF THE BEST CUISINE

**SAMBONET PADERNO INDUSTRIE S.P.A.**

Via Giovanni Coppo 1,C - 28060 Orfengo (NO) - Italy

Ph. +39 0321 1916 601

Fax +39 0321 1916 890

[horeca@paderno.it](mailto:horeca@paderno.it)

[www.hotel.paderno.it](http://www.hotel.paderno.it)

**ROSENTHAL SAMBONET USA LTD.**

685 Route 10 - Randolph NJ 07869 - USA

Ph. +1 201 804 8000

Fax +1 201 842 9195

[info@rosenthalusa.com](mailto:info@rosenthalusa.com)

[www.rosenthal-hotel-restaurant.com](http://www.rosenthal-hotel-restaurant.com)

MEMBER  
OF   
ARCTURUS GROUP

XA9084 - Ed. 7/2020

