

A chef with a beard and tattoos, wearing a white chef's coat, is plating a dish. He is using a small stainless steel saucepan to pour a vibrant red sauce onto a white plate. He also uses a spoon to drizzle the sauce. In the background, there are stainless steel pots and pans on a stove, and a whisk lies on the wooden countertop in the foreground.

PADERNO[®]

WORLD CUISINE

Partner
of the Best
Cuisine

2018—19





Factory

Fondata nel 1925 come "Alluminio Paderno" e specializzata nella produzione di pentole in alluminio per il settore casalingo, Paderno è attualmente un marchio leader a livello mondiale nella fabbricazione e commercializzazione di pentolame professionale e articoli da cucina per la ristorazione e per l'industria dell'ospitalità.

Nel 1997, in seguito all'acquisizione di Sambonet da parte di Paderno s.r.l. nasce Sambonet Paderno Industrie S.p.A.. Sambonet rappresenta dalla metà dell'ottocento l'eccellenza italiana, a livello internazionale, nella produzione di posateria e vasellame argentato e in acciaio inox dagli stili più classici fino alle sperimentazioni di design.

Paderno e Sambonet approdano nel 2001 a Orfengo (Novara), costituendo il proprio quartier generale in un nuovo e moderno stabilimento firmato dall'Architetto Enrico Frigerio. Nell'azienda si concentrano non solo le attività produttive, il magazzino, un moderno laboratorio, ma anche gli uffici, lo showroom, l'outlet e un'area ricreativa dedicata ai dipendenti. Nel 2009, con l'acquisto della prestigiosa società tedesca Rosenthal, Sambonet Paderno Industrie S.p.A. arricchisce il proprio portafoglio marchi (Sambonet, Paderno e Arthur Krupp) integrandolo con prestigiosi brand tedeschi del settore della porcellana come Rosenthal, Thomas e Hutschenreuther e, nel 2013, Arzberg. Il Gruppo italiano si completa nel 2015 con Ercuis - prestigiosa argenteria francese - e la nota azienda produttrice di porcellana di Limoges Raynaud, del quale possiede il 55% delle quote. Forte della propria offerta e leader nella produzione di articoli di design d'alta qualità per la tavola e la cucina, Arcturus Group è oggi in grado di soddisfare tutte le esigenze dei canali Ho.Re.Ca, contract e dettaglio.

I prodotti Paderno sono distribuiti attraverso rivenditori specializzati in tutti i comparti della ristorazione (come ristoranti, fastfood, alberghi e comunità, ospedali, navi da crociera ed enti militari). Grazie a oltre 90 anni di storia e della presenza capillare in tutto il mondo, Paderno si propone internazionalmente come un punto di riferimento indispensabile per tutti i professionisti della ristorazione. Gli articoli di produzione sono inoltre affiancati da un'importante gamma di prodotti complementari e affini accuratamente selezionati e realizzati da ditte altamente qualificate.

Founded in 1925 under the name of "Alluminio Paderno" and specialised in the production of aluminium pots and pans for the household, today Paderno is a leading international brand in the manufacture and sale of professional cookware and kitchen items for the restaurant and hospitality industry.

The 1997 saw the set-up of Sambonet Paderno Industrie S.p.A., following the acquisition of Sambonet by Paderno s.r.l.. Since the mid-nineteenth century, Sambonet has been a standard-bearer for Italian excellence throughout the world, producing flatware and holloware in silver-plated and stainless steel, from a classic to a modern and design-driven style. In 2001, Paderno and Sambonet arrived in Orfengo (Novara), where the headquarters of the Group were set up in a new and modern plant designed by architect Enrico Frigerio. This facility houses not only the factory, the warehouse and a modern laboratory, but also the showroom, the outlet store and a recreation area for staff.

In 2009, the acquisition of the prestigious German company Rosenthal allowed Sambonet Paderno Industrie S.p.A. to enhance its brand portfolio (Sambonet, Paderno and Arthur Krupp) with the addition of leading names in the porcelain sector, including Rosenthal, Thomas and Hutschenreuther, in 2013, Arzberg. In 2015, the Italian Group acquires Ercuis - prestigious french silverware industry - and Raynaud, famous Limoges porcelain producer, of which it owns the 55% of the share. Leader in the production of high-quality design articles for the table and the kitchen, today Arcturus Group is able to satisfy every need of Ho.Re.Ca channels, both contract and retail. Paderno products are distributed through specialised distributors in all segments of the hospitality industry (such as restaurants, fast food outlets, hotels and community facilities, hospitals, cruise ships and military bodies). Thanks to more than 90 years history and the worldwide widespread presence, Paderno an indispensable international benchmark for all professionals in the catering sector. A remarkable range of complementary articles, carefully selected and crafted by highly qualified companies, completes the Paderno produced collection.

Ho.Re.Ca.

T 0321 19 16 601
T 0321 879 601
F 0321 19 16 890
F 0321 879 890

horeca@paderno.it
horeca@sambonet.it

Retail

T 0321 19 16 701
T 0321 879 701
F 0321 19 16 830
F 0321 879 830

retail@paderno.it
retail@sambonet.it

Customer Service

T 0321 19 16 630
T 0321 879 630
F 0321 19 16 847
F 0321 879 847

resi@paderno.it
resi@sambonet.it

www.paderno.it
www.hotel.paderno.it



PADERNO

Green & Human

Il rispetto dell'ambiente e della persona sono temi rilevanti all'interno della responsabilità d'impresa di Sambonet Paderno Industrie S.p.A. Il Gruppo ha impostato e sviluppa tutt'oggi la propria evoluzione con un impegno di crescita sostenibile garantendo condizioni lavorative che possano soddisfare i bisogni delle persone nei differenti momenti della loro vita aziendale e applicando soluzioni volte a diminuire l'impronta ecologica. In quest'ottica, la gestione dei consumi energetici, elettrici e idrici è orientata a:

- impiegare energia elettrica pulita e rinnovabile;
- utilizzare il metano come unica fonte di combustibile;
- servirsi, per la produzione, di acqua di falda da restituire all'ambiente completamente depurata;
- usare tecnologia di risparmio energetico avanzata.

The respect for the environment and for the people is a relevant issue for Sambonet Paderno Industrie S.p.A. Corporate Responsibility. The commitment to sustainable growth on which the Group was founded has been maintained and permits both to guarantee adequate working conditions in order to satisfy the changing needs of the staff and to apply solutions aimed at reducing the environmental impact. From this perspective, the management of energy, electricity and water consumption focuses on:

- the use of electrical energy: clean, renewable and in harmony with the environment;
- the use of methane as the sole fuel source;
- the use of ground water for the manufacturing process, to be fully purified before being released into the environment;
- the use of an advanced energy-saving technology.

Sustainability Report

Sambonet Paderno Industrie S.p.A. lavora per attuare forme di misurazione che siano in grado di documentare la puntualità, la trasparenza e l'impegno messo in atto per uno sviluppo sostenibile. Da qui la creazione della propria carta dei principi, 10 principi, 10 impegni su cui, attraverso un approccio preventivo e una gestione responsabile, l'Azienda costruisce il proprio futuro industriale.

Bilancio di Sostenibilità dell'Azienda
corporate.sambonet.it/csr.html

UNI EN ISO 14001:2004

La certificazione ambientale garantisce i risultati di una politica ambientale volta al continuo miglioramento delle proprie performance minimizzando ogni impatto negativo delle sue attività verso l'ambiente.

UNI EN ISO 50001:2011

L'adesione volontaria alla norma UNI EN ISO 50001:2011 testimonia l'impegno e la visione dell'azienda verso l'ottimizzazione del consumo responsabile dell'energia, sia in termini economici auspicando a una riduzione dei consumi, e soprattutto verso una crescente attenzione ambientale diminuendo le emissioni di gas serra.

OHSAS 18001:2007

La certificazione ha l'obiettivo di tutelare la sicurezza e la salute dei propri lavoratori e dell'ambiente lavorativo. Sambonet Paderno Industrie S.p.A. è la prima Azienda appartenente al settore metalmeccanico ad ottenere l'attestazione.

Sambonet Paderno Industrie S.p.A. strives to implement forms of measurement to assess the punctuality, the transparency and the efforts made for sustainable development. This has led to the preparation of the corporate charter of principles, 10 principles, 10 commitments, on which the Company builds its industrial future from a perspective based on preventive approach and stewardship.

Corporate Sustainability Report
corporate.sambonet.it/csr.html

The UNI EN ISO 14001:2004 environmental certification is the recognition that the environmental policy results in a continuous improvement of environmental performance by minimising the negative impact of its operations on the environment.

The voluntary compliance with the standard UNI EN ISO 50001:2011 demonstrates the company's commitment and vision towards responsible energy consumption, factoring in both the economic hope of reducing consumption and, above all, the desire to increase environmental awareness about reducing greenhouse gas emissions.

The OHSAS 18001:2007 safety certification has the objective of protecting the safety of the workplace and the health of workers. Sambonet Paderno Industrie S.p.A. is the first Italian company in its sector that has obtained this certification.

Social Responsibility

Sostenibilità, trasparenza e interazione con gli stakeholder sono le parole chiave della politica di Sambonet Paderno industrie S.p.A.. L'azienda prosegue la sua tradizione di impresa socialmente responsabile acquisendo – per prima nel settore - l'importante **certificazione SR10**. Questo traguardo rappresenta una garanzia in fatto di trasparenza e attenzione nell'interazione con i portatori d'interessi quali dipendenti, clienti, fornitori, comunità locali e associazioni sul territorio.

Rilasciata da Certquality, il più grande network mondiale di enti certificatori, la SR10 definisce i requisiti oggettivi di una Corporate Responsibility. Un sistema di gestione che rende tangibile l'impegno aziendale nella promozione della responsabilità e della rendicontazione verso gli stakeholder del proprio operato, nel rispetto dei loro interessi e in considerazione dei principi di legalità e tutela dei diritti umani.

Sustainability, transparency and interaction with stakeholders are the key words of Sambonet Paderno Industrie S.p.A. policy. The company continues its tradition as a socially responsible company achieving, as the first one in the sector, the important **SR10 certification**. This goal represents a guarantee in terms of transparency and attention in the interaction with stakeholders like employees, clients, suppliers, local communities and associations.

The SR10, issued by Certquality - the largest global network of management system certifications - determines Corporate Responsibility objective requirements. A system that makes visible the company commitment in the promotion of responsibility and the reporting to the stakeholders, respecting their interests and considering legality's principles and human rights.

Certifications

UNI EN ISO 22000

Prima nel suo settore Sambonet Paderno Industrie S.p.A. ha ottenuto la certificazione EN UNI ISO 22000:2005. Così come per l'intero comparto food and beverage, anche per il Gruppo la UNI EN ISO 22000:2005 rappresenta lo standard di più alto livello su scala internazionale. L'applicazione dei suoi requisiti, congiuntamente all'applicazione dell'HACCP (Hazard Analysis and Critical Control Points, sistema di autocontrollo igienico che previene i pericoli di contaminazione), garantisce alla clientela un servizio sicuro ed impeccabile attraverso una valutazione puntuale e scrupolosa delle condizioni igieniche e sanitarie delle attività e dei prodotti. Una garanzia di tutela non solo per il personale del canale professionale ma anche, e soprattutto, per il consumatore finale.

UNI EN ISO 9001:2015

La certificazione di qualità conforme ai requisiti della normativa internazionale garantisce la produzione e la commercializzazione di prodotti di qualità, che soddisfino pienamente i requisiti e le aspettative del cliente.

NSF

La certificazione è stata conseguita per alcuni prodotti grazie al superamento delle rigorose norme applicate negli USA circa i materiali a contatto con gli alimenti. Il marchio NSF (National Sanitation Foundation) è sinonimo di garanzia per i costruttori, ispettori ed utilizzatori.

AEO

La certificazione comunitaria AEO Semplificazioni doganali e Sicurezza, conseguita nel 2008, garantisce un'attività disciplinata della regolamentazione doganale dell'azienda qualificandola in fatto di affidabilità e sicurezza nella catena di approvvigionamento internazionale. Nel 2011, inoltre, Sambonet Paderno Industrie S.p.A. ha ottenuto il mutuo riconoscimento del programma AEO con l'amministrazione doganale giapponese, condizione che favorisce ulteriormente i rapporti con il paese.

MITTENTE CONOSCIUTO

L'approvazione "Mittente Conosciuto" rilasciata da ENAC (Ente Nazionale Aviazione Civile) riconosce l'Azienda come sito d'origine di merce idonea al trasporto su aeromobili di qualsiasi tipo, in conformità alle procedure e disposizioni comuni di sicurezza.

ECCELLENZA 2006

Certiquality ha attribuito a Sambonet Paderno Industrie S.p.A. il Certificato di Eccellenza per aver implementato un sistema di gestione integrata di Qualità, Ambiente e Sicurezza. L'ambito riconoscimento è ottenuto da poche aziende in Italia certificate ISO 9001, ISO 140001 e BS OHSAS 18001.

AWARD FOR EXCELLENCE

Nel 2006 Sambonet Paderno Industrie S.p.A. è stata insignita dell'Award for Excellence per l'innovazione, rilasciato da Confindustria in riferimento al framework per l'innovazione dell'EFQM-European Foundation for Quality Management.

UNI EN ISO 22000

Sambonet Paderno Industrie is the first company in its industry that has been awarded the EN UNI ISO 22000:2005 certification. This certification attests to the highest international standard both for the Group and for the whole food and beverage industry. The implementation of its requirements, along with the implementation of HACCP (Hazard Analysis and Critical Control Points, a hygiene system that prevents contamination hazards), ensures the provision of a safe and impeccable service to customers by meticulously and scrupulously assessing the hygienic and safety conditions of activities and products. This is a guarantee not only for HoReCa professionals, but also, and foremost, for final consumers.

UNI EN ISO 9001:2015

This quality certification ensures compliance with the requirements of the international UNI EN ISO 9001:2008 standard, which guarantees the production and sale of quality products that fully meet customers' needs and expectations.

NSF

Some products by Sambonet Paderno Industrie S.p.A. have obtained the prestigious NSF (National Sanitation Foundation) certification for compliance with the strict standards applied in the USA to materials in contact with foodstuffs. The NSF mark is a guarantee for manufacturers, inspectors and users.

AEO

In 2008 Sambonet Paderno Industrie S.p.A. obtained the AEO Certification for Customs Simplifications and Security and Safety, valid for the EU. This programme provides a framework for governing customs regulations, guaranteeing that the company provides a reliable and secure service within the international supply chain. In addition, in 2011, Sambonet Paderno Industrie S.p.A. obtained the mutual recognition of the AEO programme with the Japanese customs administration, thus further improving customs relations with Japan.

KNOWN CONSIGNOR

The "Known Consignor" approval issued by ENAC (Italian Civil Aviation Authority) certifies that the company is an originator of cargo suitable for carriage on any aircraft, in compliance with common safety procedures and provisions.

ECCELLENZA 2006

This prestigious certificate of Excellence, awarded by Certiquality to Sambonet Paderno Industrie S.p.A. for the implementation of an integrated Quality, Environmental and Safety management system, has been granted only to few companies in Italy that have obtained the ISO 9001, ISO 140001 and BS OHSAS 18001 certifications.

AWARD FOR EXCELLENCE

In 2006 Sambonet Paderno Industrie S.p.A. received the Award for Excellence for Innovation by Confindustria (the main organization representing Italian manufacturing and services companies) with reference to the framework for innovation of the EFQM-European Foundation for Quality Management.

UNI EN ISO 22000



SISTEMA DI GESTIONE
PER LA SICUREZZA
ALIMENTARE CERTIFICATO
CERTIFICATO N° 18888

UNI EN ISO 9001



SISTEMA DI GESTIONE
QUALITÀ CERTIFICATO
CERTIFICATO N° 10571

UNI EN ISO 14001



SISTEMA DI GESTIONE
AMBIENTALE CERTIFICATO
CERTIFICATO N° 8728

BS OHSAS 18001



SISTEMA DI GESTIONE
SICUREZZA CERTIFICATO
CERTIFICATO N° 10573

UNI CEI EN ISO 50001



SISTEMA DI GESTIONE
DELL'ENERGIA CERTIFICATO
CERTIFICATO N° 21636

UNI EN ISO 9001
UNI EN ISO 14001
BS OHSAS 18001



SISTEMI DI GESTIONE
CERTIFICATI
CERTIFICATO N° 093



ASEC LAB

ALIMENTARY
SECURITY
CONTROL
LABORATORY



ASECLAB1@SAMBONET.IT



LABORATORIO DI ANALISI
INTERNO CERTIFICATO



LAB N°1407

Oltre alla conformità rispetto alle norme vigenti, gli articoli prodotti e commercializzati da Sambonet Paderno Industrie S.p.A. sono controllati in maniera sistematica. Grazie alla costituzione di un gruppo di lavoro e del laboratorio interno ASEC Lab (Alimentary Security Control), specializzato nell'analisi di materiali destinati al contatto con gli alimenti, l'Azienda è in grado di garantire l'idoneità e la sicurezza dei propri prodotti. Il laboratorio è oggi accreditato per realizzare internamente test di migrazione su acciaio, alluminio, porcellana, vetro, materiali plastici e coloranti per il rilascio di dichiarazioni di conformità, riconosciute da qualsiasi ente nazionale e internazionale. ASEC Lab è inoltre accreditato per la determinazione di pH, solventi e metalli nelle acque di scarico, una garanzia per le analisi interne sulla qualità delle proprie acque di scarico.

The items produced and sold by Sambonet Paderno Industrie S.p.A. not only comply with applicable regulations, but are also systematically tested. The Company can guarantee the suitability and safety of its products as it has established a specific workgroup and the ASEC Lab (Alimentary Security Control) internal laboratory, which analyses the materials intended to come into contact with foodstuffs. The laboratory is now accredited to carry out migration testing on steel, aluminum, porcelain, glass, entirely plastic materials and coloring in order to issue declarations of compliance, recognized by both national and international governments. The ASEC Lab is also accredited to determine pH levels, solvents and metals in water discharge, a guarantee for the internal analysis of the wastewater quality.



index

Pentolame
Cookware, pots & pans
Kochgeschirr
Batteries de cuisine
Baterías de cocina

8



Utensili da cucina
Kitchen utensils
Küchenzubehöre
Ustensiles de cuisine
Utensilios de cocina

65



Coltelleria
Knives
Kochmesser
Coutellerie
Cuchillería

184



Stoccaggio e trasporto
Storage & transport
Lagerung und Transport
Stockage & transport
Almacenamiento y transporte

214



Tavola
Table top service
Tischservice
Service de table
Servicio de mesa

249



Accessori tavola
Table accessories
Tischzubehör
Accessoires de table
Accesorios de mesa

314



Gelateria, bar, buffet
Ice-Cream, bar, buffet
Eis-artikel, Bar, Buffet
Glace, bar, buffet
Heladería, bar, buffet

324



Pasticceria
Pastry utensils
Konditorei-Artikel
La pâtisserie
Pastelería

420



COOKWARE

PENTOLAME
COOKWARE, POTS & PANS
KOCHEGESHIRR
BATTERIES DE CUISINE
BATERÍAS DE COCINA

SERIE 1100



Finitura esterna ed interna satinata, bordo lucido.
Manicatura tubolare in acciaio inox, anatomica, resistente al calore.
Bordo rinforzato.
Doppio spessore del fondo.
Fondo termodiffusore sandwich (inox-alluminio-inox).
Concavo a freddo e piano a caldo (sfruttamento del calore al 100%).
Ideali per ogni tipo di cottura, gas, elettrica, vetroceramica e induzione.
Tutti gli articoli sono dotati di speciale fondo termodiffusore adatto anche per piastre ad induzione.

Outside and inside satin polished. Top edges mirror polished.
Hollow tubular stay cool handles in stainless steel, ergonomically shaped.
Extra thick edges.
Double thick bottom.
Sandwich thermoradiant bottom (stainless steel-aluminum-stainless steel).
Concave bottom when cold and flat when hot (100% heat exploiting).
Perfect for use on any type of stove, whether gas, electric, glass ceramic cooking surface or induction stove. All items have an induction-suited sandwich bottom.



NSF

Pentola
Stock pot
Hoher Suppentopf
Marmite traiteur
Olla recta

art.	Ø cm.	h.	lt.
11101-16	16	16	3,2
11101-20	20	20	6,2
11101-24	24	24	10,0
11101-28	28	28	16,5
11101-32	32	32	24,0
11101-36	36	36	36,0
11101-40	40	40	50,0
11101-45	45	45	70,0
11101-50	50	50	100,0



NSF

Pentola bassa
Low stock pot
Gemüsetopf
Faitout
Olla recta baja

art.	Ø cm.	h.	lt.
11105-16	16	14	2,7
11105-20	20	17	5,0
11105-24	24	21	8,5
11105-28	28	23	14,5
11105-32	32	26	22,0
11105-36	36	28	29,0
11105-40	40	32	40,0



NSF

Casseruola alta
Saucepot
Fleischtopf
Brasière
Cacerola alta

art.	Ø cm.	h.	lt.
11107-16	16	11,0	2,1
11107-20	20	13,0	4,0
11107-24	24	15,0	6,5
11107-28	28	17,5	10,8
11107-32	32	19,5	15,7
11107-36	36	21,5	22,0
11107-40	40	24,5	30,8
11107-45	45	27,5	44,0
11107-50	50	32,0	63,0



NSF

Casseruola bassa
Casserole pot
Bratentopf
Sautoir
Cacerola baja

art.	Ø cm.	h.	lt.
11109-16	16	7,5	1,3
11109-20	20	8,0	2,5
11109-24	24	9,5	4,3
11109-28	28	11,0	6,7
11109-32	32	12,5	10,0
11109-36	36	14,0	14,2
11109-40	40	15,5	19,5
11109-45	45	17,0	27,0
11109-50	50	19,0	37,0



NSF

Colapasta per pentola
Colander for stock pot
Seiher für Suppentopf
Passoire pour marmite
Colador para olla recta

art.	Ø cm.	h.
11123-20	20	22,0
11123-24	24	26,5
11123-28	28	29,5

Per art. 11105 e art. 11101.
Suitable for both item 11105 and 11101.



Pentola con rubinetto
Stock pot with tap
Hochtopf mit Hahn
Marmite avec robinet
Olla con grifo

art.	Ø cm.	h.	lt.
11102-28	28	28	16,5
11102-32	32	32	24,0
11102-36	36	36	36,0
11102-40	40	40	50,0
11102-45	45	45	70,0
11102-50	50	50	100,0



NSF

Inserto a vapore, fondo forato
Steamer pot, perforated bottom
Dampf-Siebeinsatz
Casserole à vapeur, perforée
Cacerola base perforada

art.	Ø cm.	h.
11119-20	20	12,5
11119-24	24	15,0
11119-28	28	17,0
11119-32	32	19,0



11161

11119

11105



NSF

Casseruola alta
Saucepan
Stielkasserolle, hoch
Casserole haute
Cazo recto alto

art.	Ø cm.	h.	lt.
11106-14	14	8,0	1,2
11106-16	16	11,0	2,1
11106-20	20	13,0	4,0
11106-24	24	15,0	6,5
11106-28*	28	17,5	10,8
11106-32*	32	19,5	15,7
11106-36*	36	21,5	22,0

* Con contromaniglia. - With loop handle.



Casseruola bassa
Sauté pan
Stielkasserolle, niedrig
Plat à sauter
Cazo recto bajo

art.	Ø cm.	h.	lt.
11108-16	16	6,5	1,3
11108-20	20	8,0	2,5
11108-24	24	9,5	4,3
11108-28*	28	11,0	6,7
11108-32*	32	12,5	10,0
11108-36*	36	14,0	14,2

* Con contromaniglia. - With loop handle.



Casseruola conica
Sauté pan
Sauteuse
Sauteuse
Cazo cónico

art.	Ø cm.	h.	lt.
11112-16	16	6,0	1,0
11112-18	18	6,0	1,2
11112-20	20	6,5	1,6
11112-24	24	7,5	2,7



Casseruola "bombé"
Curved sauté pan
Sauteuse mit Schüttrand
Sauteuse bombé
Cazo bombeado

art.	Ø cm.	h.	lt.
11113-18	18	7,0	1,7
11113-20	20	7,5	2,2
11113-24	24	8,5	3,3
11113-26	26	9,0	4,2



Padella
Frypan
Bratpfanne
Poêle à frire
Sartén

art.	Ø cm.	h.
11114-20	20	5,0
11114-24	24	5,0
11114-28	28	5,5
11114-32	32	6,0
11114-36*	36	6,0
11114-40*	40	6,0
11114-45*	45	6,5

* Con contromaniglia. - With loop handle.



Padella, antiaderente
Frypan, non stick coating
Bratpfanne mit Antihafbeschichtung
Poêle avec revêtement anti-adhésif
Sartén antiaderente

art.	Ø cm.	h.
11117-20	20	5,0
11117-24	24	5,0
11117-28	28	5,5
11117-32	32	6,0
11117-36	36	6,0
11117-40	40	6,0



Tegame
French omelet pan
Servierpfanne
Poêle à paella
Paellera

art.	Ø cm.	h.
11115-20	20	5,0
11115-24	24	5,0
11115-28	28	5,5
11115-32	32	6,0
11115-36	36	6,0
11115-40	40	6,0
11115-45	45	6,5
11115-50	50	8,0



Coperchio, bordo rinforzato
Cover, reinforced edge
Deckel mit Randverstärkung
Couvercle, bord renforcé
Tapa, borde reforzado

art.	Ø cm.
11161-12	12
11161-14	14
11161-16	16
11161-20	20
11161-24	24
11161-28	28
11161-32	32
11161-36	36
11161-40	40
11161-45	45
11161-50	50
11161-60	60



SERIE 2100

**INDUCTION
READY!**



La serie 2100 ha le stesse caratteristiche della serie 1100.
Differisce solo per una diversa manicatura sugli articoli a 2 maniglie.
Ideali per ogni tipo di cottura, gas, elettrica, vetroceramica e induzione.
Tutti gli articoli sono dotati di speciale fondo termodiffusore adatto anche per piastre ad induzione.

The serie 2100 has the same characteristics of the serie 1100.
It varies only for the shape of the handles of 2 handles items.
Perfect for use on any type of stove, whether gas, electric, glass ceramic cooking surface or induction stove. All items have an induction-suited sandwich bottom.



NSF

Pentola
Stock pot
Hoher Suppentopf
Marmite traiteur
Olla recta

art.	Ø cm.	h.	lt.
12101-16	16	16	3,2
12101-20	20	20	6,2
12101-24	24	24	10,0
12101-28	28	28	16,5
12101-32	32	32	24,0
12101-36	36	36	36,0
12101-40	40	40	50,0
12101-45	45	45	70,0
12101-50	50	50	100,0



NSF

Casseruola alta
Saucepot
Fleischtopf
Brasière
Cacerola alta

art.	Ø cm.	h.	lt.
12107-16	16	11,0	2,1
12107-20	20	13,0	4,0
12107-24	24	15,0	6,5
12107-28	28	17,5	10,8
12107-32	32	19,5	15,7
12107-36	36	21,5	22,0
12107-40	40	24,5	30,8
12107-45	45	27,5	44,0
12107-50	50	32,0	63,0



NSF

Casseruola bassa
Casserole pot
Bratentopf
Sautoir
Cacerola baja

art.	Ø cm.	h.	lt.
12109-16	16	7,5	1,3
12109-20	20	8,0	2,5
12109-24	24	9,5	4,3
12109-28	28	11,0	6,7
12109-32	32	12,5	10,0
12109-36	36	14,0	14,2
12109-40	40	15,5	19,5
12109-45	45	17,0	27,0
12109-50	50	19,0	37,0

SERIE 1000



Finitura esterna ed interna satinata.
Bordo a versare.
Manicatura tubolare in acciaio inox, anatomica, resistente al calore.
Parete e fondo a spessore uniforme.
Fondo termodiffusore sandwich (inox-alluminio-inox).
Concavo a freddo e piano a caldo (sfruttamento del calore al 100%).
Ideali per ogni tipo di cottura, gas, elettrica, vetroceramica e induzione.
Tutti gli articoli sono dotati di speciale fondo termodiffusore adatto anche per piastre ad induzione.

Outside and inside satin polished.
Non-drip edge.
Hollow tubular stay cool handles in stainless steel, ergonomically shaped.
Uniform thickness in sides and bottoms.
Sandwich thermoradiant bottom (stainless steel-aluminum-stainless steel).
Concave bottom when cold and flat when hot (100% heat exploiting).
Perfect for use on any type of stove, whether gas, electric, glass ceramic cooking surface or induction stove. All items have an induction-suited sandwich bottom.



Casseruola mezza alta
Saucepan
Bratentopf, mittelhoch
Casserole
Cacerola francés

art.	Ø cm.	h.	lt.
11010-16	16	8	1,6
11010-18	18	9	2,3
11010-20	20	10	3,1
11010-24	24	12	5,4



Casseruola mezza alta
Saucepan
Stielkasserolle, mittelhoch
Casserole
Cazo recto francés

art.	Ø cm.	h.	lt.
11011-16	16	8	1,6
11011-18	18	9	2,3
11011-20	20	10	3,1
11011-24	24	12	5,4



Casseruola conica
Sauté pan
Sauteuse
Sauteuse
Cazo cónico

art.	Ø cm.	h.	lt.
11012-16	16	6,0	1,0
11012-18	18	6,0	1,2
11012-20	20	6,5	1,6
11012-24	24	7,5	2,7



Casseruola bombé
Curved sauté pan
Sauteuse mit Schüttrand
Sauteuse bombé
Cazo bombeado

art.	Ø cm.	h.	lt.
11013-18	18	7,0	1,7
11013-20	20	7,5	2,2
11013-24	24	8,5	3,3
11013-26	26	9,0	4,2



Pentola
Stock pot
Hoher Suppentopf
Marmite traiteur
Olla recta

art.	Ø cm.	h.	lt.
11001-16	16	16	3,2
11001-18	18	16	4,0
11001-20	20	18	5,5
11001-22	22	22	8,3
11001-24	24	24	10,5
11001-28	28	28	17,0
11001-32	32	32	25,5
11001-36	36	36	36,5
11001-40	40	40	50,0
11001-45	45	40	63,5
11001-50	50	50	98,0
11001-60	60	55	150,0



Casseruola alta
Saucepot
Fleischtopf
Brasière
Cacerola alta

art.	Ø cm.	h.	lt.
11007-16	16	9,5	1,9
11007-18	18	10,8	2,7
11007-20	20	12,0	3,8
11007-22	22	13,0	5,0
11007-24	24	14,5	6,5
11007-28	28	16,0	9,8
11007-32	32	19,5	15,4
11007-36	36	21,5	20,5
11007-40	40	24,0	30,1
11007-45	45	27,0	42,9
11007-50	50	30,0	58,0
11007-60	60	35,0	99,0



Casseruola bassa
Casserole pot
Bratentopf
Sautoir
Cacerola baja

art.	Ø cm.	h.	lt.
11009-16	16	6,5	1,3
11009-18	18	7,0	1,8
11009-20	20	7,5	2,5
11009-24	24	8,0	3,7
11009-28	28	9,5	5,8
11009-32	32	11,0	9,2
11009-36	36	13,0	13,0
11009-40	40	14,5	18,0
11009-45	45	15,5	24,6
11009-50	50	19,0	37,0
11009-60	60	25,0	70,7



Padella
Frypan
Bratpfanne
Poêle à frire
Sartén

art.	Ø cm.	h.
11014-20	20	5,0
11014-24	24	5,0
11014-28	28	5,5
11014-32	32	6,0
11014-36*	36	6,0
11014-40*	40	6,0
11114-45*	45	6,5

* Con contromaniglia. - With loop handle.



Padella, antiaderente
Frypan, non stick
Bratpfanne, nichttaftend
Poêle, anti-adhérente
Sartén antiaderente

art.	Ø cm.	h.
11117-20	20	5,0
11117-24	24	5,0
11117-28	28	5,5
11117-32	32	6,0
11117-36	36	6,0
11117-40	40	6,0



Tegame
French omelet pan
Servierpfanne
Poêle à paella
Paellera

art.	Ø cm.	h.
11115-20	20	5,0
11115-24	24	5,0
11115-28	28	5,5
11115-32	32	6,0
11115-36	36	6,0
11115-40	40	6,0
11115-45	45	6,5
11115-50	50	8,0



Casseruola alta
Saucepan
Stielkasserolle, hoch
Casserole haute
Cazo recto alto

art.	Ø cm.	h.	lt.
11006-12	12	7,0	0,8
11006-14	14	8,0	1,2
11006-16	16	9,5	1,9
11006-18	18	10,8	2,7
11006-20	20	12,0	3,8
11006-22	22	13,0	5,0
11006-24	24	14,5	6,5
11006-28*	28	16,0	9,8
11006-32*	32	19,5	15,4
11006-36*	36	21,5	20,5

* Con contromaniglia. - With loop handle.



Casseruola bassa
Sauté pan
Stielkasserolle, niedrig
Plat à sauter
Cazo recto bajo

art.	Ø cm.	h.	lt.
11008-16	16	6,5	1,3
11008-18	18	7,0	1,8
11008-20	20	7,5	2,5
11008-24	24	8,0	3,7
11008-28*	28	9,5	5,8
11008-32*	32	11,0	9,2
11008-36*	36	13,0	13,0

* Con contromaniglia. - With loop handle.



Coperchio, bordo rinforzato
Cover, reinforced edge
Deckel mit Randverstärkung
Couvercle, bord renforcé
Tapa, borde reforzado

art.	Ø cm.
11061-16	16
11061-18	18
11061-20	20
11061-22	22
11061-24	24
11061-28	28
11061-32	32
11061-36	36
11061-40	40
11061-45	45
11061-50	50
11161-60	60

SERIE 2000



La serie 2000 ha le stesse caratteristiche della serie 1000. Differisce solo per una diversa manicatura sugli articoli a 2 maniglie. Ideali per ogni tipo di cottura, gas, elettrica, vetroceramica e induzione. Tutti gli articoli sono dotati di speciale fondo termodiffusore adatto anche per piastre ad induzione.

The serie 2000 has the same characteristics of the serie 1000. It varies only for the shape of the handles of 2 handles items. Perfect for use on any type of stove, whether gas, electric, glass ceramic cooking surface or induction stove. All items have an induction-suited sandwich bottom.



Pentola
Stock pot
Hoher Suppentopf
Marmite traiteur
Olla recta

art.	Ø cm.	h.	lt.
12001-16	16	16	3,2
12001-18	18	16	4,0
12001-20	20	18	5,5
12001-22	22	22	8,3
12001-24	24	24	10,5
12001-28	28	28	17,0
12001-32	32	32	25,5
12001-36	36	36	36,5
12001-40	40	40	50,0
12001-45	45	40	63,5
12001-50	50	50	98,0
12001-60	60	55	150,0



Casseruola alta
Saucepot
Fleischtopf
Brasière
Cacerola alta

art.	Ø cm.	h.	lt.
12007-16	16	9,5	1,9
12007-18	18	10,8	2,7
12007-20	20	12,0	3,8
12007-22	22	13,0	5,0
12007-24	24	14,5	6,5
12007-28	28	16,0	9,8
12007-32	32	19,5	15,4
12007-36	36	21,5	20,5
12007-40	40	24,0	30,1
12007-45	45	27,0	42,9
12007-50	50	30,0	58,0
12007-60	60	35,0	99,0



Casseruola bassa
Casserole pot
Bratentopf
Sautoir
Cacerola baja

art.	Ø cm.	h.	lt.
12009-16	16	6,5	1,3
12009-18	18	7,0	1,8
12009-20	20	7,5	2,5
12009-24	24	8,0	3,7
12009-28	28	9,5	5,8
12009-32	32	11,0	9,2
12009-36	36	13,0	13,0
12009-40	40	14,5	18,0
12009-45	45	15,5	24,6
12009-50	50	19,0	37,0
12009-60	60	25,0	70,7



Inserto a vapore, fondo forato
Steamer pot, perforated bottom
Dampf-Siebeinsatz
Casserole à vapeur, perforée
Cacerola base perforada

art.	Ø cm.	h.
12119-20	20	12,5
12119-24	24	15,0
12119-28	28	17,0
12119-32	32	19,0



Pentola cuociasparagi con coperchio
Asparagus-pot with lid
Spargeltopf mit Deckel
Cuit-asperges avec couvercle
Olla espárragos con tapa

art.	Ø cm.	h.	lt.
12037-16	16	24	4,8



Casseruola mezza alta
Saucepan
Stielkasserolle, mittelhoch
Casserole
Cazo recto francés

art.	Ø cm.	h.	lt.
11011-16	16	8	1,6
11011-18	18	9	2,3
11011-20	20	10	3,1
11011-24	24	12	5,4



Casseruola conica
Sauté pan
Sauteuse
Sauteuse
Cazo cónico

art.	Ø cm.	h.	lt.
11012-16	16	6,0	1,0
11012-18	18	6,0	1,2
11012-20	20	6,5	1,6
11012-24	24	7,5	2,7



Casseruola "bombé"
Curved sauté pan
Sauteuse mit Schüttertrand
Sauteuse bombé
Cazo bombeado

art.	Ø cm.	h.	lt.
11013-18	18	7,0	1,7
11013-20	20	7,5	2,2
11013-24	24	8,5	3,3
11013-26	26	9,0	4,2



Casseruola alta
Saucepan
Stielkasserolle, hoch
Casserole haute
Cazo recto alto

art.	Ø cm.	h.	lt.
11006-12	12	7,0	0,8
11006-14	14	8,0	1,2
11006-16	16	9,5	1,9
11006-18	18	10,8	2,7
11006-20	20	12,0	3,8
11006-22	22	13,0	5,0
11006-24	24	14,5	6,5
11006-28*	28	16,0	9,8
11006-32*	32	19,5	15,4
11006-36*	36	21,5	20,5

* Con contromaniglia. - With loop handle.



Casseruola bassa
Sauté pan
Stielkasserolle, niedrig
Plat à sauter
Cazo recto bajo

art.	Ø cm.	h.	lt.
11008-16	16	6,5	1,3
11008-18	18	7,0	1,8
11008-20	20	7,5	2,5
11008-24	24	8,0	3,7
11008-28*	28	9,5	5,8
11008-32*	32	11,0	9,2
11008-36*	36	13,0	13,0

* Con contromaniglia. - With loop handle.



Padella
Frypan
Bratpfanne
Poêle à frire
Sartén

art.	Ø cm.	h.
11014-20	20	5,0
11014-24	24	5,0
11014-28	28	5,5
11014-32	32	6,0
11014-36*	36	6,0
11014-40*	40	6,0
11114-45*	45	6,5

* Con contromaniglia. - With loop handle.



Padella, antiaderente
Frypan, non stick coating
Bratpfanne mit Antihafbeschichtung
Poêle avec revêtement anti-adhésif
Sartén antiadherente

art.	Ø cm.	h.
11117-20	20	5,0
11117-24	24	5,0
11117-28	28	5,5
11117-32	32	6,0
11117-36	36	6,0
11117-40	40	6,0



Tegame
French omelet pan
Servierpfanne
Poêle à paella
Paellera

art.	Ø cm.	h.
11115-20	20	5,0
11115-24	24	5,0
11115-28	28	5,5
11115-32	32	6,0
11115-36	36	6,0
11115-40	40	6,0
11115-45	45	6,5
11115-50	50	8,0



Coperchio, bordo rinforzato
Cover, reinforced edge
Deckel mit Randverstärkung
Couvercle, bord renforcé
Tapa, borde reforzado

art.	Ø cm.
11061-16	16
11061-18	18
11061-20	20
11061-22	22
11061-24	24
11061-28	28
11061-32	32
11061-36	36
11061-40	40
11061-45	45
11061-50	50
11161-60	60



Pentola a pressione
Pressure cooker
Schnellkochtopf
Autocuiseur
Olla de presión

art.	Ø cm.	h.	lt.
49800-15	32	19	15

Valvola di sicurezza - Safety valve



- 4 valvole di sicurezza indipendenti
- Coperchio con sistema di chiusura facile da usare
- Fondo Sandwich Impact Bonded
- Distribuzione del calore rapida ed efficiente
- Acciaio inox 18/10
- Facile da pulire con attacchi coperchio rimovibili

Valvola rilascio vapore - Steam release



- 4 independent safety valves
- Lid with easy to use locking system
- Impact Bonded Sandwich Bottom
- Fast and efficient heat distribution
- 18/10 stainless steel
- Easy cleaning with removable lid attachments

FOR **GLUTEN-FREE** **COOKING**



AL SERVIZIO DELLA CUCINA SENZA GLUTINE

PADERNO[®]

WORLD CUISINE



Coerentemente all'ottica di servizio che contraddistingue da sempre il marchio, Paderno propone una linea completa di articoli e strumenti professionali facilmente identificabili in cucina, in grado di abbattere eventuali errori durante il loro utilizzo a salvaguardia del cliente celiaco e di tutti gli intolleranti. Sviluppato e concretizzato nel 2013 in collaborazione con l'Associazione Italiana Celiachia Lombardia ONLUS, questo progetto colloca Sambonet Paderno Industrie come prima azienda del settore a offrire al canale Ho.Re.Ca una linea completa di articoli da destinare alla preparazione di pietanze senza glutine.

Attraverso alcuni elementi distintivi e differenzianti, come manici in PVD oro per pentole e padelle e personalizzazione con un logo specifico per utensili, tutti gli strumenti saranno facilmente identificabili in cucina. Questa gamma contribuisce a:

- Diminuire il rischio di accidentali contaminazioni crociate degli alimenti;
- Facilitare il professionista nell'operare e nell'offrire un servizio a favore del cliente con intolleranze alimentari;
- Sensibilizzare il settore sul tema "gluten free" di fronte alle nuove esigenze dei consumatori.

Consistently with the functional approach, which has always marked the brand, Paderno offers a complete product line and professional tools, easily recognizable in the kitchen, which can reduce possible mistakes during their use to protect people affected by celiac disease. Developed and realized in 2013 in collaboration with Associazione Italiana Celiachia Lombardia ONLUS (Italian Society for the Celiac Disease – Lombardy Section), this project makes Sambonet Paderno Industrie S.p.A. the first company in its market that offers to the HoReCa channel a complete line of items intended for gluten-free cooking.

Some distinguished special features, such as golden PVD handles for pans and pots and a special customised logo for utensils, will allow professionals to easily identify all these items in the kitchen.

This product line aims at:

- Reducing the risk of accidental food cross-contamination;
- Making it easier for professionals to work and provide services to clients with food intolerances;
- Raising awareness on the gluten-free diet issue in the industry so as to respond to the new needs of consumers.

SERIE 2500 3-PLY

INDUCTION
READY!



La serie Paderno 2500 3-ply concepita per l'utilizzo nelle cucine professionali è costruita in materiale multistrato che assicura una distribuzione rapida ed uniforme del calore su tutta la superficie dell'utensile.

Finitura esterna ed interna satinata.

Bordo a versare.

Manicatura anatomica in acciaio inox.

Parete e fondo a spessore uniforme.

Risparmio di energia su tutti i piani di cottura.

Ideali per ogni tipo di cottura inclusa l'induzione.

Paderno serie 2500 3-ply is especially designed for professional kitchens, features super heat-conductive multi-layer construction that distributes heat from bottom to rim quickly and evenly.

Outside and inside satin polished.

Non-drip edge.

Stainless steel handles, ergonomically shaped.

Uniform thickness in sides and bottoms.

Energy saving on all types of cookers.

Suitable for all cooking ranges, induction hobs included.



Casseruola alta
Saucepot
Fleischtopf
Brasière
Cacerola alta

art.	Ø cm.	h.	lt.
12507-24	24	11,5	5,0
12507-28	28	14,0	8,5



Casseruola bassa
Casserole pot
Bratentopf
Sautoir
Cacerola baja

art.	Ø cm.	h.	lt.
12509-20	20	9,5	2,8
12509-24	24	10,5	4,7
12509-28	28	11,0	6,5



Casseruola mezza alta
Saucepan
Stielkasserolle, mittelhoch
Casserole
Cazo recto francés

art.	Ø cm.	h.	lt.
12511-16	16	7,5	1,5
12511-18	18	8,0	2,0
12511-20	20	8,8	2,5
12511-24	24	10,5	4,6



Casseruola bassa
Sauté pan
Stielkasserolle, niedrig
Plat à sauter
Cazo recto bajo

art.	Ø cm.	h.	lt.
12508-24	24	5,0	2,0



Casseruola bombé
Curved sauté pan
Sauteuse mit Schüttrand
Sauteuse bombé
Cazo bombeado

art.	Ø cm.	h.	lt.
12513-16	16	6,0	1,2
12513-18	18	6,5	1,6
12513-20	20	7,0	2,0
12513-24	24	8,5	3,8



Padella
Frypan
Bratpfanne
Poêle à frire
Sartén

art.	Ø cm.	h.
12514-20*	20	3,0
12514-24	24	5,5
12514-26	26	5,5
12514-28	28	5,5
12514-32	32	4,0
12514-36	36	4,0

* Finitura lucida. - Mirror finishing.



Wok c/griglia e coperchio
Wok with grid and cover
Wok mit Rost und Deckel
Wok avec grille et couvercle
Wok con rejilla y tapa

art.	Ø cm.	h.
12529-32	32	8



Padella, antiaderente
Frypan, non stick coating
Bratpfanne mit Antihftbeschichtung
Poêle avec revêtement anti-adhésif
Sartén antiadherente

art.	Ø cm.	h.
12517-24	24	5,5
12517-26	26	5,5
12517-28	28	5,5
12517-32	32	5,5
12517-36	36	5,5



Coperchio
Cover
Deckel
Couvercle
Tapa

art.	Ø cm.
12561-16	16
12561-18	18
12561-20	20
12561-24	24
12561-26	26
12561-28	28



Casseruola alta, con coperchio
Saucepot with lid
Fleischtopf mit Deckel
Brasière avec couvercle
Cacerola alta con tapa

art.	Ø cm.	h.	lt.
12509-12*	12	6	0,7



Casseruola bassa
Sauté pan
Stielkasserolle, niedrig
Plat à sauter
Cazo recto bajo

art.	Ø cm.	h.	lt.
12511-12*	12	6	0,7
12511-14*	14	7	1,0



Casseruola bassa con doppio becco
Sauté pan with double spouts
Stielkasserolle, niedrig, 2 Schnabel
Plat à sauter, 2 becs
Cazo recto bajo, 2 picos

art.	Ø cm.	h.	lt.
12511-10*	10	5,0	0,4

* Finitura lucida. - Mirror finishing.

COMPLEMENTI *BAKING PANS*

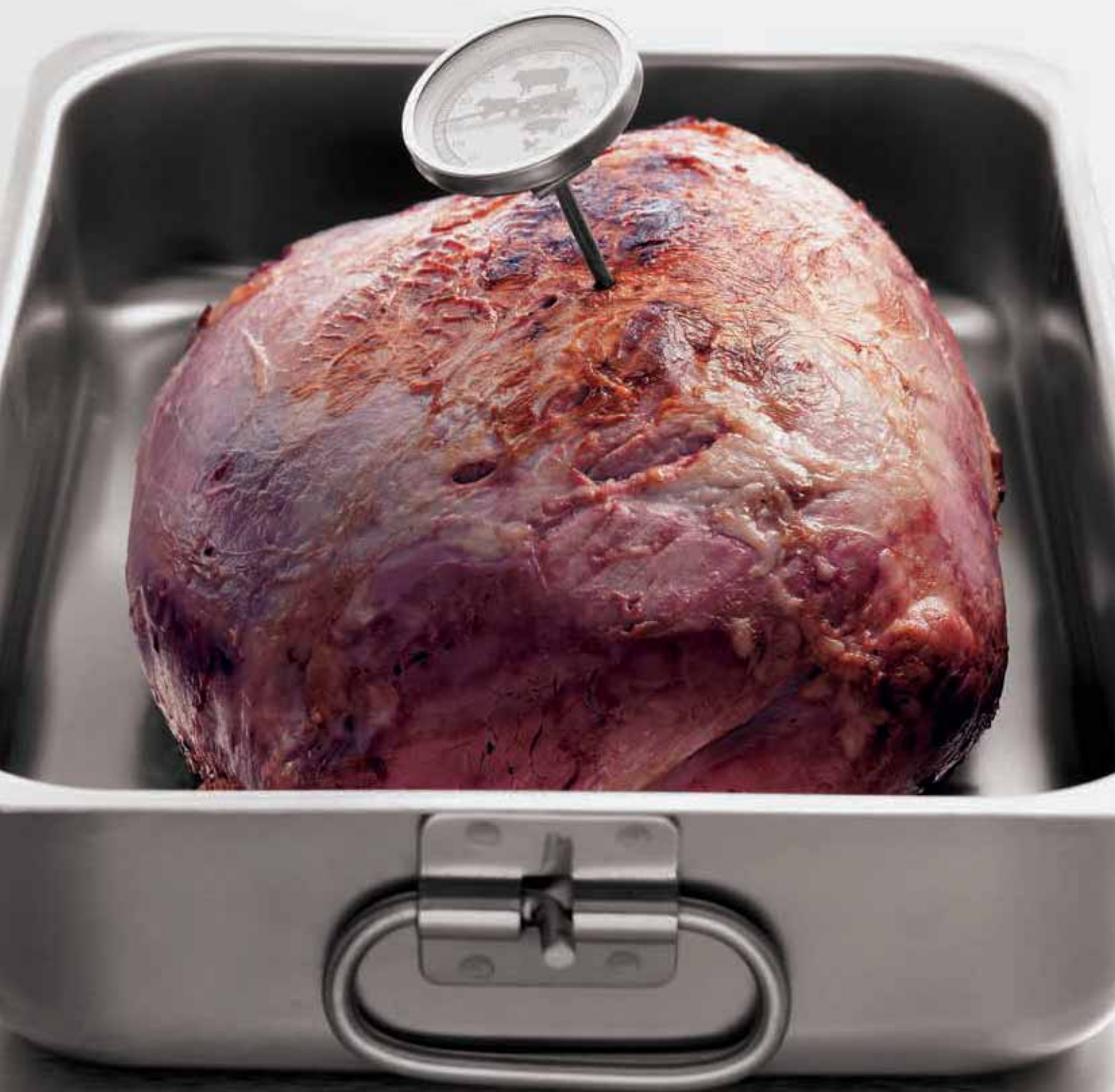



Tegame
Roasting pan
Bräter
Plaque à rôtir
Rustidera

art.	dim. cm.	h.
11941-35	35x25	8
11941-40	40x26	9
11941-45	45x30	9
11941-50	50x30	9
11941-60*	60x35	9

*Per forno GN 2/1. - For 2/1 GN ovens.



Tegame pesante
Heavy roasting pan
Bräter, Schwerausführung
Plaque à rôtir lourde
Rustidera pesada

art.	dim. cm.	h.
11943-40	40x26	9
11943-45	45x30	9
11943-50	50x30	9
11943-60	60x35	9
11943-61*	61x43	9

*Per forno GN 2/1. - For 2/1 GN ovens.



Tegame pesante
Heavy roasting pan
Bräter, Schwerausführung
Plaque à rôtir lourde
Rustidera pesada

art.	dim. cm.	h.
11944-40	40x26	9
11944-45	45x30	9
11944-50	50x30	9
11944-60	60x35	9
11944-61*	61x43	9

*Per forno GN 2/1. - For 2/1 GN ovens.



Coperchio
Lid
Deckel
Couvercle
Tapa

art.	dim. cm.
11948-40	40x26
11948-45	45x30
11948-50	50x30
11948-60	60x35
11948-61*	61x43

*Per forno GN 2/1. - For 2/1 GN ovens.



Brasiera con coperchio
Roasting pan with cover
Brasiere mit Deckel
Braisière avec couvercle
Rustidera alta con tapa

art.	dim. cm.	h.
11965-50	50x30	15
11965-60	60x35	15
11965-61*	61x43	15

*Per forno GN 2/1. - For 2/1 GN ovens.



Pesciera
Fish kettle
Fischkochkessel
Poissonnière
Hervidor pescado

art.	dim. cm.	h.	lt.
11963-60	60x20	14	14
11963-99	100x25	20	44

Fornita completa di griglia e coperchio.
Equipped with grid and cover.



Pesciera
Fish kettle
Fischkochkessel
Poissonnière
Hervidor pescado

art.	dim. cm.	h.
41964-45	47x16	11,5
41964-60	61x19	12,5

Fornita completa di griglia e coperchio.
Equipped with grid and cover.



Bollitore
Whistling kettle
Kocher
Bouilloire à sifflet
Pava

art.	lt.
41914-03	2,8



Rete paraspruzzi
Splatter screen
Pfannenspritzschutz
Écran anti-éclaboussures
Red antisalpicadura

art.	ø. cm.
11917-28	28
11917-34	34

Manico ABS. - ABS handle.



Contenitore cilindrico
Canister
Behälter
Bahut
Contenedor cilíndrico

art.	Ø cm.	h.	lt.
11913-16	16	12	2,4
11913-20	20	16	5,0
11913-24	24	20	9,0
11913-28	28	24	14,5



Casseruola bagnomaria
Bain-marie pot
Wasserbadkasserolle
Casserole bain-marie
Baño maria

art.	Ø cm.	h.	lt.
11910-12	12	14	1,4
11910-14	14	16	2,5
11910-16	16	18	3,6
11910-18	18	20	5,0
11910-20	20	22	7,0



Bagnomaria
Bain-marie pot
Behälter
Casserole bain-marie
Baño maria

art.	Ø cm.	h.	lt.
11911-12	12	14	1,4
11911-14	14	16	2,5
11911-16	16	18	3,6
11911-18	18	20	5,0
11911-20	20	22	7,0



Bagno-maria impilabili
Bain-marie, stackable
Bain-Marie, stapelbar
Bain-marie, empilables
Baño maria, apilable

art.	dim. cm.	h.	lt.
44501-01	24x24	23,5	13
44501-02	24x24	16,0	9
44501-03	24x24	7,5	4



Bagno-maria impilabili
Bain-marie, stackable
Bain-Marie, stapelbar
Bain-marie, empilables
Baño maria, apilable

art.	dim. cm.	h.	lt.
44502-01	15,5x15,5	23,5	5,0
44502-02	15,5x15,5	16,0	3,5
44502-03	15,5x15,5	7,5	1,5



Bagno-maria impilabili
Bain-marie, stackable
Bain-Marie, stapelbar
Bain-marie, empilables
Baño maria, apilable

art.	dim. cm.	h.	lt.
44503-01	15,5x10,5	16,0	2,5
44503-02	15,5x10,5	7,5	1,0
44503-03	15,5x10,5	5,5	0,5

Robusti e maneggevoli, non scottano.
Efficienti, la rete aumenta la velocità di colatura e consente di colare anche il riso senza disperdere i chicchi.
Strong and handy, stay cool grip, efficient, the gauze improves the speed of strain and also perfect for rice.



Coperchio bagnomaria
Bain-marie lid
Wasserbadkasserolle-Deckel
Couverte pour bain-marie
Tapa para baño maria

art.	dim. cm.
44501-04	24x24
44502-04	15,5x15,5
44503-04	15,5x10,5



Colapasta 1/4
1/4-Segment colander
1/4 Seiher-Einsatz
Passoire cuit-pâtes, 1/4
Colador 1/4

art.	Ø cm.	h.	lt.
11922-36	36	23	5,5
11922-40	40	26	7,5



Colapasta 1/4 a rete
1/4-Segment wire colander
1/4 Netzseiher-Einsatz
Passoire cuit-pâtes à gaze, 1/4
Colador red 1/4

art.	Ø cm.	h. cm.
12992-36	36	23
12992-40	40	26



Adatti alle casseruole - art. - Suit sauce-pots items: 11007-11107-12007-12107-16929.

SERIE 6100 CRUDALLUMINIO

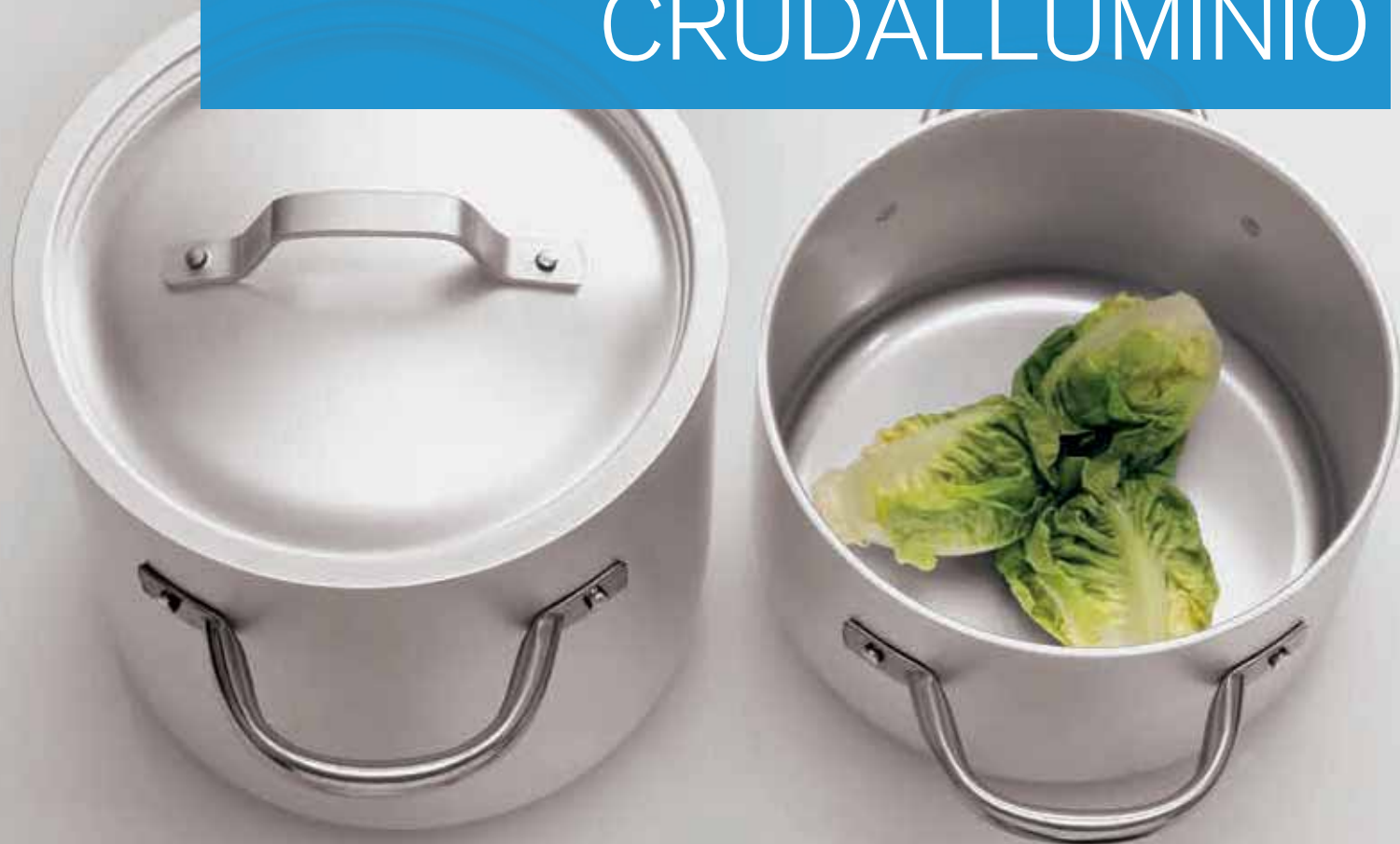

Esecuzione in alluminio pesante, per cucine elettriche e a gas.
Manicatura tubolare in acciaio inossidabile 18/10, resistente al calore.
Ampio raggio di raccordo fondo-parete, igienico e facile da pulire.
Spessore da mm 2 a mm 5,5.

Made in heavy duty aluminum, suitable both for electric and gas stoves.
Hollow tubular handles in stainless steel 18/10, stay cool.
Rounded corners provide easy cleanup.
Thickness from mm 2 to mm 5,5.



Pentola
Stock pot
Hoher Suppentopf
Marmite traiteur
Olla recta

art.	Ø cm.	h.	lt.
16101-16	16	16	3,2
16101-20	20	20	6,2
16101-24	24	24	10,0
16101-28	28	28	16,5
16101-32	32	28	21,0
16101-36	36	36	36,0
16101-40	40	40	50,0
16101-45	45	45	70,0
16101-50	50	50	100,0



Casseruola alta
Saucepot
Fleischtopf
Brasière
Cacerola alta

art.	Ø cm.	h.	lt.
16107-16	16	11,0	2,1
16107-20	20	13,0	4,0
16107-24	24	15,0	6,5
16107-28	28	17,5	10,8
16107-32	32	19,5	15,7
16107-36	36	21,0	21,5
16107-40	40	24,0	30,0
16107-45	45	27,0	43,0
16107-50	50	30,0	59,0



Casseruola bassa
Casserole pot
Bratentopf
Sautoir
Cacerola baja

art.	Ø cm.	h.	lt.
16109-24	24	9,5	4,3
16109-28	28	11,0	6,7
16109-32	32	12,5	10,0
16109-36	36	14,0	14,0
16109-40	40	16,0	20,0
16109-45	45	18,0	28,5
16109-50	50	19,0	37,0
16109-60	60	21,5	60,0



Colapasta per pentola
Colander for stock pot
Seiher für Suppentopf
Passoire pour marmite
Colador para olla recta

art.	Ø cm.	h.
16926-32	32	31
16926-36	36	37
16926-40	40	40



Couscoussiera
Couscous pan
Couscoustopf
Couscoussier
Cuscusera

art.	Ø cm.	h.	lt.
46970-18	36	22+17	18
46970-25	40	25+20	25



Casseruola a vapore con coperchio
Potato steamer pot with cover
Kartoffeldämpfer mit Deckel
Marmite à pommes-de-terre avec couvercle
Cuscusera con tapa

art.	Ø cm.	h.	lt.
16923-32	32	21+15	12
16923-36	36	23+17	18
16923-40	40	25+20	25



Casseruola ovale con coperchio
Oval saucepan with cover
Ovale Kasserolle mit Deckel
Casserole ovale avec couvercle
Cacerola oval con tapa

art.	Ø cm.	h.	lt.
16938-36	36	14,5	10
16938-40	40	16,0	14
16938-45	45	17,0	19



Casseruola alta
Saucepan
Stielkasserolle, hoch
Casserole haute
Cazo recto alto

art.	Ø cm.	h.	lt.
16106-16	16	11,0	2,1
16106-20	20	13,0	4,0
16106-24	24	15,0	6,5
16106-28	28	17,5	10,8



Casseruola bassa
Casserole pot
Stielkasserolle, niedrig
Sautoir
Cacerola baja

art.	Ø cm.	h.	lt.
16108-20	20	8,0	2,5
16108-24	24	9,5	4,3
16108-28	28	11,0	6,7



Padella
Frypan
Bratpfanne
Poêle à frire
Sartén

art.	Ø cm.	h.
16114-20	20	4,0
16114-24	24	5,0
16114-28	28	5,0
16114-32	32	5,3
16114-36	36	6,0
16114-40	40	7,0



Tegame
French omelet pan
Servierpfanne
Poêle à paella
Paellera

art.	Ø cm.	h.
16115-24	24	5,5
16115-28	28	6,0
16115-32	32	6,5
16115-36	36	7,0
16115-40	40	7,5
16115-45	45	7,5



Coperchio
Cover
Deckel
Couvercle
Tapa

art.	Ø cm.
16961-16	16
16961-20	20
16961-24	24
16961-28	28
16961-32	32
16961-36	36
16961-40	40
16961-45	45
16961-50	50
16961-60	60



Casseruola alta, antiaderente
Casserole pot, non stick
Fleischtopf, nichttaftend
Brasière, anti-adhérente
Cacerola alta, antiadherente

art.	Ø cm.	h.	lt.
16127-16	16	11,0	2,1
16127-20	20	13,0	4,0
16127-24	24	15,0	6,5
16127-28	28	17,5	10,8
16127-32	32	19,5	15,7
16127-36	36	21,0	21,5
16127-40	40	24,0	30,0



Casseruola bassa, antiaderente
Casserole pot, non stick
Bratentopf, nichttaftend
Sautoir, anti-adhérente
Cacerola baja, antiadherente

art.	Ø cm.	h.	lt.
16120-24	24	9,5	4,3
16120-28	28	11,0	6,7
16120-32	32	12,5	10,0
16120-36	36	14,0	14,0
16120-40	40	16,0	20,0



Tegame, antiaderente
French omelet pan, non stick
Servierpfanne, nichttaftend
Poêle à paella, anti-adhérente
Paellera antiadherente

art.	Ø cm.	h.
16116-28	28	6,5
16116-32	32	6,5
16116-36	36	7,0
16116-40	40	7,5



Padella, antiaderente
Frypan, non stick
Bratpfanne, nichttaftend
Poêle, anti-adhérente
Sartén antiadherente

art.	Ø cm.	h.
41720-18	18	3,8
41720-20	20	3,8
41720-24	24	4,5
41720-28	28	5,4
41720-30	30	5,4
41720-32	32	5,6



Padella, rivestimento in ceramica
Frypan, ceramic coating
Bratpfanne, keramische Beschichtung
Poêle, revêtement céramique
Sartén cobertura en ceramica

art.	Ø cm.	h.
11720-18	18	3,8
11720-20	20	3,8
11720-24	24	4,5
11720-28	28	5,4
11720-30	30	5,4
11720-32	32	5,6



Padella, antiaderente
Frypan, non stick
Bratpfanne, nichttaftend
Poêle, anti-adhérente
Sartén antiadherente

art.	Ø cm.	h.
16117-20	20	4,0
16117-24	24	5,0
16117-28	28	5,0
16117-32	32	5,3
16117-36	36	6,0
16117-40	40	7,0



Padella, antiaderente
Frypan, non stick
Bratpfanne, nichttaftend
Poêle, anti-adhérente
Sartén antiadherente

art.	Ø cm.	h.
16147-20	20	3,4
16147-24	24	4,2
16147-28	28	4,5
16147-32	32	5,5
16147-36	36	6,0
16147-40	40	6,0



Padella forgiata, antiaderente
Forged frypan, non stick
Pfanne, geschmiedet, nichttaftend
Poêle forgée, anti-adhérente
Sartén forjada, antiadherente

art.	Ø cm.	h.
11617-20	20	3,4
11617-24	24	4,2
11617-28	28	4,5
11617-32	32	5,5
11617-36	36	6,0

PENTOLAME ALLUMINIO ALUMINUM COOKWARE



Tegame forgiato, rivestimento ceramica
 Forged omelet pan, ceramic coating
 Servierpfanne, geschmiedet, keramische Beschichtung
 Poêle forgée, revêtement céramique
 Paellere forjada, cobertura ceramica

art.	Ø cm.	h.
11619-20	20	3,4
11619-24	24	4,2
11619-28	28	4,5
11619-32	32	5,5
11619-36	36	6,0



Padella bombata antiaderente, manico ferro
 Frypan, non stick, cast iron handle
 Bratpfanne, nichttaftend, Gusseisen-Stiel
 Poêle bombé, anti-adhérente, queue fonte
 Sartén antiadherente, mango hierro

art.	Ø cm.	h.
16113-20	20	5,5
16113-24	24	6,5
16113-28	28	7,0
16113-32	32	7,5
16113-36	36	8,0
16113-40	40	8,5



Padella antiaderente, manico ferro
 Frypan, non stick, cast iron handle
 Bratpfanne, nichttaftend, Gusseisen-Stiel
 Poêle, anti-adhérente, queue fonte
 Sartén antiadherente, mango hierro

art.	Ø cm.	h.
16717-20	20	4,0
16717-24	24	5,0
16717-28	28	5,0
16717-32	32	5,3
16717-36	36	6,0
16717-40	40	7,0



Padella crêpes, antiaderente
 Crêpes pan, non stick
 Crêpepfanne, nichttaftend
 Poêle à crêpes, anti-adhérente
 Sartén crêpes antiadherente

art.	Ø cm.
16118-24	24



La crespella (in francese: crêpe) è una cialda sottile a base di latte, uova e farina. Farcita di ripieni vari, dolci o salati è generalmente considerata una pietanza tipica della cucina francese.

The pancake (in French: crêpe) is a type of thin wafer made from milk, eggs and flour. Usually stuffed with various fillings, sweet or salty and rolled up this pancake is generally considered as a typical French dish.



Padella crêpes antiaderente
 Crêpes pan, non-stick
 Crêpes-Pfanne, nichttaftend
 Tuile à crêpes anti-adhérente
 Sartén para crêpes, antiadherente

art.	Ø cm.
16712-22	22
16712-26	26
16712-30	30



Padella per blini, antiaderente
 Non-stick blinis pan
 Blinis-Pfännchen, nichttaftend
 Poêle à blinis, anti-adhérente
 Sartén blinis, antiadherente

art.	Ø cm.	h.
16719-12	12	2



Tegame
 Bake roasting pan
 Pfanne
 Plat à four
 Rustidera

art.	dim. cm.	h.
16941-40	40x26	7,5
16941-45	45x30	7,5
16941-50	50x30	8,0
16941-60	60x35	9,0
16941-61*	61x43	9,0

*Per forno GN 2/1. - For 2/1 GN ovens.



Tegame
 Bake roasting pan
 Pfanne
 Plat à four
 Rustidera

art.	dim. cm.	h.
16943-40	40x26	7,5
16943-45	45x30	7,5
16943-50	50x30	8,0
16943-60	60x35	9,0
16943-61*	61x43	9,0

*Per forno GN 2/1. - For 2/1 GN ovens.



Tegame, antiaderente
Bake roasting, non stick
Pfanne, nichtaftend
Plat à four, anti-adhérente
Rustidera antiaderente

art.	dim. cm.	h.
16947-40	40x26	7,5
16947-45	45x30	7,5
16947-50	50x30	8,0
16947-60	60x35	9,0
16947-61*	61x43	9,0

*Per forno GN 2/1. - For 2/1 GN ovens.



Tegame basso
Bake roasting pan
Pfanne, flach
Plat à four bas
Bandeja horno

art.	dim. cm.	h.
16944-45	45x30	4
16944-50	50x30	4
16944-60	60x35	4



Coperchio per tegami
Lid for roasting pans
Deckel für Bräter
Couvercle pour plaques à rôtir
Tapa para rustidera

art.	dim. cm.
16948-40	40x26
16948-45	45x30
16948-50	50x30
16948-60	60x35
16948-61	61x43



Brasiera con coperchio
Roasting pan with cover
Brasiere mit Deckel
Braisière avec couvercle
Rustidera alta con tapa

art.	dim. cm.	h.	lt.
16965-40	40x26	15	14
16965-50	50x30	15	21
16965-60	60x35	15	30



Pesciera
Fish kettle
Fisch-Kochkessel
Poissonnière
Hervidor pescado

art.	dim. cm.	h.	lt.
16939-50	50x15	12	9
16939-60	60x17	13	13
16939-70	70x19	14	18
16939-80	80x24	17	30

Fornita completa di griglia e coperchio.
Equipped with grid and cover.



PA⁺
plus

Colapasta a spicchi 1/4, rete
1/4-Segment wire colander
1/4 Netzseiher-Einsatz
Passoire cuit-pâtes à gaze, 1/4
Colador red 1/4

art.	Ø cm.	h. cm.
12992-36	36	23
12992-40	40	26



Casseruola, alluminio
Sauce-pot, aluminum
Gemüsetopf, Aluminium
Braisière, alu
Cacerola, aluminio

art.	Ø cm.	h.	lt.
16929-36	36	17	17,0
16929-40	40	18	22,5

Fornita senza spicchi.
Supplied without colanders.



Bagnomaria
Bain-marie pot
Wasserbadkasserolle
Casserole bain-marie
Baño maria

art.	Ø cm.	h.	lt.
16910-14	14	16	2,5
16910-16	16	18	3,7
16910-18	18	20	5,0
16910-20	20	22	7,0



Colafritto, inox
Fry dripping tray, stainless steel
Pommes-Frites-Seiher, Edelstahl Rostfrei
Egouttoir à friture, inox
Ecurridor para fritura, inox

art.	Ø cm.
41930-39	39

PADELLE FERRO STEEL FRYING PANS

**INDUCTION
READY!**



Il ferro è ottimo per le cotture a fuoco molto vivo perché, non avendo un'alta capacità di trasmettere calore, evita improvvisi sbalzi di temperatura. Essendo un materiale antiaderente, evita l'attaccamento dei cibi. Sopporta temperature elevatissime e col tempo migliora il suo rendimento. I recipienti in ferro sono i più adatti per frittture, omelette o sottili crêpes. La padella in ferro nera va lavata con acqua il meno possibile e mantenuta sempre unta. Il ferro è il materiale ideale anche per cotture a induzione.

Iron is ideal for cooking at high temperatures because its low capacity of heat transmission prevents temperature leaps. As it is non-stick, food does not stick to it. It withstands very high temperatures and improves its performance with use. Iron pans are perfect for fried food, omelettes or fine crêpes. Wash the black iron pan in water as little as possible and always keep it greased. Iron pans are ideal also for cooking on induction hobs.



Padella lionese, pesante
Heavy blacksteel frypan
Schwere Eisenpfanne
Coupe lyonnaise extra-forte
Sartén honda pesada

art.	Ø cm.	h.
11714-20	20	3,8
11714-22	22	4,0
11714-24	24	4,5
11714-26	26	4,5
11714-28	28	4,5
11714-32	32	5,0
11714-36	36	5,5
11714-40	40	5,5
11714-45	45	5,5
11714-50	50	6,0



Padella lionese
Blacksteel frypan
Eisenpfanne
Coupe lyonnaise
Sartén honda

art.	Ø cm.	h.
11716-16	16	4,0
11716-20	20	4,5
11716-22	22	4,5
11716-24	24	5,0
11716-26	26	5,5
11716-28	28	5,5
11716-32	32	6,0
11716-36	36	6,5
11716-40	40	7,0
11716-45	45	8,0



Padella per paella
Blacksteel paella pan
Paella Eisenpfanne
Coupe lyonnaise à paella
Paellera

art.	Ø cm.	h.
11717-34	34	5,0
11717-37	37	5,5
11717-42	42	6,0
11717-47	47	6,5



Padella per paella
Blacksteel paella pan
Paella Eisenpfanne
Coupe lyonnaise à paella
Paellera

art.	Ø cm.	h.
41717-60	60	6,5
41717-80	80	9,0



Padella ovale
Blacksteel fish pan
Fischeisenpfanne, oval
Coupe ovale
Sartén oval

art.	dim. cm.	h.
41719-32	32x23	5,0
41719-36	36x26	5,0
41719-40	40x28	5,5



Padella crêpes
Blacksteel crêpes pan
Crêpes Eisenpfanne
Coupe lyonnaise à crêpes
Sartén crêpes

art.	Ø cm.	h.
11718-20	20	2
11718-22	22	2
11718-24	24	2



Padella crêpes, alluminio antiaderente
Crêpes pan, aluminum, non-stick coated
Crêpes -Pfanne, Aluminum, nichthaftend
Poêle à crêpes, alu, anti-adhérente
Sartén crêpes, aluminio, antiadherente

art.	dim. cm.	h.
16971-36	36,5x22,5	3,5



Padella per blini
Blinis pan
Blinis-Eisenpfännchen
Poêle à blinis
Sartén blinis

art.	Ø cm.	h.
11715-12	12	2



Padella ovale
Blacksteel fish pan
Fischeisenpfanne, oval
Coupe ovale
Sartén oval

art.	dim. cm.
41703-38	38x26



Wok
Wok pan
Wok-Pfanne
Poêle chinoise
Wok

art.	Ø cm.	h.
11713-32	32	10
11713-40	40	11



Padella per castagne
Chestnut pan
Kastanienpfanne
Poêle à marrons
Sartén para castañas

art.	Ø cm.
11721-28	28



Coprimanico silicone
Silicone sleeve
Silikon-Stielhu"lle
Revêtement manche en silicone
Cubre mango silicona

art.	Ø cm.	col.
11710-AA	20-36	●
11710-AB	40-50	●

Coprimanico in silicone ideale per tutte le padelle con manico in ferro. Garantisce una gradevole presa, resistente al calore fino a 230°C, non scalda e si toglie agevolmente per una facile pulizia. - The silicone cool touch sleeve slides onto cast iron fry pan handles for more secure food handling and slide off for easy cleaning. Heat resistant up to 230°C. Adatto alle padelle art. - Suits fry pans items: 16717 - 16113 - 16712 - 11714 - 11716 - 11718 - 11713 - 11721.



Padella per friggere
Fry pan
Frittier-Pfanne
Tuile à frire
Sartén freidora

art.	Ø cm.	h.	lt.
41707-32	32	9,8	6,0
41707-36	36	11,0	8,8
41707-40	40	13,4	12,2
41707-45	45	15,0	17,3
41707-50	50	17,6	23,5



Cestello per friggere, stagnato
Wire basket, tinned
Frittier-Rost, verzinkt
Grille à frire, étamée
Cesta escurrefrito, estañada

art.	Ø cm.	h.
41708-32	32	11,0
41708-36	36	11,5
41708-40	40	12,4
41708-45	45	15,5
41708-50	50	16,5



SERIE 15500



Ideale per cucinare e servire nello stesso recipiente. Uno strumento di lavoro con un corpo formato da tre metalli, rame, alluminio e acciaio. Un mix per un'omogenea e dolce diffusione termica che assicura una cottura senza aggredire i cibi, preservandone le proprietà nutrizionali e le caratteristiche organolettiche. Lamina interna in acciaio inox, pratico e facile da pulire. Strato intermedio in alluminio, leggero e ottimo conduttore di calore. Esterno in rame finitura lucida, una tradizione in cucina, affascinante e bello da vedere. Manici e maniglie in ottone massiccio assemblati con rivetti di forte sezione. Adatto ad uso su tutti i fuochi inclusa l'induzione.

Ideal for cooking and serving from the kitchen to the table. A working tool with a body made of three metals, copper, aluminum and steel. A mix for a homogenous and sweet thermal spread that ensures cooking without attacking the foods, preserving its nutritional properties and organoleptic characteristics. Inside stainless steel, practical and easy to clean. Middle layer aluminum, lightweight and a very good heat conductor. Exterior glossy copper finishing, a tradition in the kitchen, fascinating and beautiful to see. Solid brass handles assembled with strong section rivets. Suitable for use on all cooking hobs including induction.



Casseruola alta
Saucepan
Stielkasserolle, hoch
Casserole haute
Cazo recto alto



art.	ø cm.	h.	lt.
15506-16	16	8	1,6
15506-20	20	11	3,5
15506-24	24	14	6,3
15506-28	28	16	9,8



Casseruola alta
Saucepot
Fleischtopf
Brasière
Cacerola alta



art.	ø cm.	h.	lt.
15507-16	16	8	1,6
15507-20	20	11	3,5
15507-24	24	14	6,3
15507-28	28	16	9,8



Casseruola bassa
Casserole pot
Stielkasserolle, niedrig
Sautoir
Cacerola baja



art.	ø cm.	h.	lt.
15508-20	20	7	2,2
15508-24	24	8	3,6
15508-28	28	9	5,5



Casseruola bassa
Casserole pot
Bratentopf
Sautoir
Cacerola baja



art.	ø cm.	h.	lt.
15509-20	20	7	2,2
15509-24	24	8	3,6
15509-28	28	9	5,5



Padella
Frypan
Bratpfanne
Poêle à frire
Sartén



art.	ø cm.	h.	lt.
15514-20	20	4,5	1,4
15514-24	24	4,5	2,0
15514-28	28	5,5	3,4
15514-32	32	6,0	4,8



Coperchio
Cover
Deckel
Couvercle
Tapa



art.	ø cm.
15561-20	20
15561-24	24
15561-28	28



SERIE 15300-15400



Rame massiccio, spessore da 1,5 a 2,5 mm internamente stagnato a mano sulla fiamma. Manici e maniglie in ottone massiccio lucidato a specchio ed assemblati con rivetti di forte sezione. Adatto ad uso su tutti i fuochi (eccetto induzione).

Solid copper, thickness from 1,5 to 2,5 mm, the interiors are tinned over the fire by hand. Handles in highly polished solid brass, assembled with wide rivets. For use on any heating element (except on induction hob).



Pentola
Stock pot
Hoher Suppentopf
Marmite traiteur
Olla recta

art.	Ø cm.	h.	lt.
15301-22	22	20	8,0



Coperchio
Cover
Deckel
Couvercle
Tapa

art.	Ø cm.
15361-22	22



Casseruola ovale
Oval saucepan
Ovaler Bratentopf
Casserole ovale
Cacerola oval

art.	dim. cm.	h.
15338-38	38x25	13



Tegame rettangolare
Bake roasting pan
Rechteckige Pfanne
Plat à four
Rustidera

art.	dim. cm.	h.
15343-36	38x28	11



Tegame ovale
Oval pan
Ovale Bratpfanne
Plat ovale à poignées
Bandeja oval

art.	dim. cm.	h.
15339-36	38x26	11



Pesciera
Fish kettle
Fischkochkessel
Poissonnière
Hervidor pescado

art.	dim. cm.	h.
15438-50	50x18	11



Bagnomaria
Bain-marie
Wasserbadkasserolle
Bain-marie
Baño maría

art.	Ø cm.	h.
15403-12	12	14,5
15403-16	16	17,0

Con porcellana. - With porcelain.



Set fonduta
Fondue set
Fondue-Service
Service à fondue
Servicio para fondues

art.	Ø cm.	h.
15430-11	16	26



Casseruolina
Small saucepan
Kleine Stielkasserolle
Casserollette
Cacerola pequeña

art.	Ø cm.	h.
15309-07	7	3



Casseruola per zucchero
Sugar saucepan
Zuckerpfännchen
Poelon à sucre
Cacerola para azúcar

art.	Ø cm.	h.
15406-16	16	9
15406-20	20	10



Casseruola per zabaione
Zabaione bowl
Zabaionekasserolle
Poelon à zabaione
Cacerola sabayón

art.	Ø cm.
15407-16	16
15407-20	20



Base per casseruola zabaione
Foot for zabaione bowl
Fuss für Zabaionekasserolle
Base pour poelon à zabaione
Base para cacerola sabayón

art.	Ø cm.	h.
15401-51	8	4,5



Bastardella semisferica
Mixing bowl
Schnees Schlagkessel
Bassine hémisphérique
Caldero

art.	Ø cm.
15409-26	26
15409-30	30
15409-36	36

Finitura smerigliata. - Frosted finishing.



Stampo scanalato
Bordelais moulds
Bordelais-Kuchenform
Moule à cannelés Bordelais
Molde para bordelais

art.	Ø cm.	h.
15415-03	5,5	5

Set 3 pezzi. - 3 pcs set.



Paiolo
Sauté pan
Kasserolle
Sauteuse
Cazo cónico

art.	Ø cm.	h.
15412-25	25	13



Casseruolina
Small saucepan
Kleine Stielkasserolle
Casserollette
Cacerola pequeña

art.	Ø cm.	h.
15306-07	7	4



Casseruolina
Small saucepan
Kleine Stielkasserolle
Casserollette
Cacerola pequeña

art.	Ø cm.	h.
15306-10	10	5

Coperchio incluso. - Lid included.



Casseruola scaldaburro
Butter warmer
Butterpfännchen
Casserole à beurre
Cacerola mantequilla

art.	Ø cm.	h.
15404-10	10	6

Con porcellana. - With porcelain.

MINIATURE MINI OVENS



Una gamma di miniature ideali per contorni e singole porzioni, soufflé, pasta al forno, creme di riso, raclette, brioche salate e dolci, desserts, ecc., ecc.. Polivalenti, funzionali, pronte per essere servite dalla cucina alla tavola. Originali eppure tradizionali, provengono dal mondo dell'alta gastronomia, strumento ideale per valorizzare creazioni estrose o le più semplici ricette, per amore della convivialità, per donare un aspetto più ludico ai nostri pasti.

A range of small pots ideal for side dishes and individual servings, soufflés, baked pasta, rice creams, raclette, savory as well as sweet pastries, desserts, etc., etc.. Versatile, functional, ready to be served from the kitchen to the table. Original and yet traditional, they come from the world of haute cuisine, ideal for enhancing creations or the most simple recipes, for the sake of conviviality, to give a more playful aspect to our meals.



Casseruola alta
Saucepan
Stielkasserole, hoch
Casserole haute
Cazo recto alto

art.	Ø cm.	h.
16136-10	10	6



Casseruola bassa
Sauté pan
Stielkasserole, niedrig
Plat à sauter
Cazo recto bajo

art.	Ø cm.	h.
16138-10	10	4



Padella
Frypan
Bratpfanne
Poêle à frire
Sartén

art.	Ø cm.	h.
16134-12	12	4



Casseruola alta
Saucepan
Fleischtopf
Casserole haute
Cazo recto alto

art.	Ø cm.	h.
16137-10	10	6



Casseruola bassa
Casserole pot
Bratentopf
Sautoir
Cacerola baja

art.	Ø cm.	h.
16139-10	10	4



Tegamino
French omelet pan
Servierpfanne
Poêle à paella
Paellera

art.	Ø cm.	h.
16135-12	12	4

Corpo in alluminio con rivestimento antiaderente, manicatura in ottone. - Aluminum body non-stick coated, brass handles.



Padella blini, alluminio antiaderente
Blinis non-stick aluminum pan
Blinis-Alupfännchen, nichthaftend
Poêle à blinis, alu anti-adhérente
Sartén blinis, antiadherente

art.	Ø cm.	h.
16719-12	12	2



Padella blini, ferro
Blinis steel frypan
Blinis-Eisenpfännchen
Poêle à blinis, acier
Sartén blinis, hierro

art.	Ø cm.	h.
11715-12	12	2



Casseruola con coperchio, 3-ply
Saucepot with lid
Fleischtopf mit Deckel
Brasière avec couvercle
Cacerola alta con tapa

art.	Ø cm.	h.	lt.
12509-12	12	6	0.7



Casseruola con due becchi, 3-ply
Sauté pan with double spouts
Stielkasserolle, niedrig, 2 Schnabel
Plat à sauter, 2 becs
Cazo recto bajo, 2 picos

art.	Ø cm.	h.	lt.
12511-10	10	5,0	0,4



Casseruola bassa, 3-ply
Sauté pan
Stielkasserolle, niedrig
Plat à sauter
Cazo recto bajo

art.	Ø cm.	h.	lt.
12511-12	12	6	0,7



Casseruola bassa, 3-ply
Sauté pan
Stielkasserolle, niedrig
Plat à sauter
Cazo recto bajo

art.	Ø cm.	h.	lt.
12511-14	14	7	1,0



N

Casseruola ovale, STONEWARE
Saucepan, oval
Kasserolle, oval
Casserole, ovale
Cacerola, oval

art.	dim. cm.	h.	u. pack
41210-03	13x8,2	3,9	6



N

Casseruola rettangolare, STONEWARE
Saucepan, rectangular
Kasserolle, rechteckig
Casserole, rectangulaire
Cacerola, rectangular

art.	dim. cm.	h.	u. pack
41210-05	13x8,2	3,9	6



N

Casseruola tonda, STONEWARE
Saucepan, round
Kasserolle, rund
Casserole, ronde
Cacerola, redonda

art.	Ø cm.	h.	u. pack
41210-01	13	3,9	6



N

Tegamimo, STONEWARE
Saucepan
Pfännchen
Sautoir
Fuente huevo

art.	Ø cm.	h.	u. pack
41210-12	13	5	6
41210-13	15	5	6
41210-14	17	5	6



N

Tortiera, STONEWARE
Piepan
Kuchenform
Ramequin
Molde tarta

art.	Ø cm.	h.	u. pack
41210-10	11	3,9	6



N

Casseruola con coperchio, STONEWARE
Saucepan with lid
Kasserolle mit Deckel
Casserole avec couvercle
Cacerola con tapa

art.	Ø cm.	h.	u. pack
41210-07	11,5	5,5	6
41210-08	13,0	7,5	6

MINIATURE RAME COPPER MINI OVENS



Rame spessore 1 mm., manici in ottone massiccio assemblati con rivetti da 3,5 mm. Interno stagnato a mano sulla fiamma con stagno vergine al 100%.

Copper thickness 1 mm., handles in highly polished solid brass, assembled with 3,5 mm. rivets. Interiors tinned over the fire by hand with 100% pure tin.



N

Coperchio
Cover
Deckel
Couvercle
Tapa

art.	ø cm.	h.
15321-08	8	2,5
15321-10	10	2,5
15321-12	12	3,0
15321-14	14	3,0



N

Padella
Frypan
Bratpfanne
Poêle à frirer
Sartén

art.	ø cm.	h.	lt.
15324-08	8	3,0	0,14
15324-10	10	3,5	0,24
15324-12	12	4,0	0,40
15324-14	14	4,5	0,70



N

Casseruola bassa
Sauté pan
Stielkasserole, niedrig
Plat à sauter
Cazo recto bajo

art.	ø cm.	h.	lt.
15328-08	8	3,5	0,16
15328-10	10	4,0	0,30
15328-12	12	4,5	0,50
15328-14	14	5,0	0,73



N

Casseruola alta
Saucepan
Stielkasserolle, hoch
Casserole haute
Cazo recto alto

art.	ø cm.	h.	lt.
15326-08	8	5,5	0,25
15326-10	10	6,5	0,45
15326-12	12	7,5	0,80
15326-14	14	8,5	1,25



N

Tegamino
French omelet pan
Servierpfanne
Poêle à paella
Paellera

art.	ø cm.	h.	lt.
15325-08	8	3,0	0,14
15325-10	10	3,5	0,24
15325-12	12	4,0	0,40
15325-14	14	4,5	0,70



N

Casseruola bassa
Casserole pot
Bratentopf
Sautoir
Cacelora baja

art.	ø cm.	h.	lt.
15329-08	8	3,5	0,16
15329-10	10	4,0	0,30
15329-12	12	4,5	0,50
15329-14	14	5,0	0,73



N

Casseruola alta
Saucepan
Fleischtopf
Casserole haute
Cazo recto alto

art.	ø cm.	h.	lt.
15327-08	8	5,5	0,25
15327-10	10	6,5	0,45
15327-12	12	7,5	0,80
15327-14	14	8,5	1,25

GHISA SMALTATA ENAMELLED CAST IRON



SLOWCOOKING-FAST GRILLING-COOK & SERVE



Idonee all'uso su tutte le fonti di cottura (gas, elettriche, vetroceramica, induzione) e forni (gas, petrolio, carbone o legna) ad esclusione di microonde. Una perfetta armonia tra ghisa, smalto e alta qualità. Progettate e costruite per assorbire e diffondere il calore in modo uniforme. La ghisa è adatta a tutte le tecniche di cottura, per zuppe, arrostiti, risotti, dolci, per piatti che richiedono una lunga cottura tipo brasati e allo stesso modo ideale per carni e verdure alla griglia in quanto ne esalta sapori ed aromi in stile barbecue. La ghisa ha anche caratteristiche di antiaderenza. La temperatura elevata della padella cauterizza la superficie della carne. Tutto il sapore, l'acqua e i valori nutrizionali rimangono sigillati nel cibo. Nella cottura in casseruole, il vapore generato grazie al particolare design del coperchio si condensa ricadendo e mescolandosi nuovamente nel cibo non solo trattenendo sapori e aromi ma fornendo la miglior protezione alle sostanze nutrienti e contribuendo ad una dieta sana. La ghisa è un materiale riciclabile al 100% e quindi ecologico. Inoltre, grazie alla sua capacità di mantenere il calore per lungo tempo consente un notevole risparmio di energia permettendo di cuocere a fuoco basso. Anche a tavola mantengono in cibi in temperatura. La ghisa mantiene però il caldo come pure il freddo... può essere usata per mantenere il cibo fresco. Riposta per un breve periodo in frigorifero, mantiene il cibo fresco nelle calde giornate estive e ideale per servire insalate di pasta, riso, farro, ecc., ecc. Pratica e facile da pulire. Queste casseruole e padelle in ghisa sono lavabili in lavastoviglie, per merito della speciale tecnologia applicata al metodo di smaltatura. Manicatura e pomoli dal design ergonomico sono in ghisa e inox. Durante la cottura si raccomanda di maneggiare con un panno consistente e asciutto per evitare di scottarsi.

Suitable for use on all cooking hobs (gas, electric, ceramic, induction) and ovens (gas, oil, coal or wood) except microwave. A perfect harmony of cast iron, enamel and high quality. Designed and constructed to absorb and spread the heat evenly. Cast iron is suitable for all cooking techniques, for soups, roasts, rice, desserts, for braise that require a long cooking and likewise ideal for meats and grilled vegetables as it enhances flavors and aromas like barbecue style. Cast iron also features non-stick. The high temperature of the pan sears the meat surface. All the flavor, water and nutritional values remain sealed in the food. When cooking in casseroles, the steam generated thanks to the special design of the cover condenses falling back into the food not only retaining flavors and aromas but providing the best protection for nutrients and contributing to a healthy diet. Cast iron is a material 100% recyclable and therefore environmentally friendly. Moreover, thanks to its ability to retain heat for a long time it allows a considerable saving of energy. With closed lid on the table, the pot will preserve the temperature for a second serving. Cast iron retains the heat but as well the cold... can be used to keep the food fresh. Stored for a short time in the refrigerator, keeps food cool during hot summer days, ideal for serving pasta or rice salads, etc. Practical and easy to clean. These cast iron pots and pans are dishwasher safe thanks to the special technology applied to their enameling method. Ergonomic knobs and handles made of cast iron and stainless steel, suitable for use on all heat sources and ovens except microwave. Be careful, they heat up during cooking, it is recommended to handle with a dry thick cloth.



Casseruola tonda con coperchio
Saucepot round with lid
Fleischtopf, rund mit Deckel
Brasière avec couvercle
Cacerola redonda con tapa

art.	ø cm.	lt.	col.
44201R10	10	0,35	●
44201V10	10	0,35	●
44201B10	10	0,35	●
44201O10	10	0,35	●
44201N10	10	0,35	●

Porzioni/Portion: 1 - Kg. 1,15.



Casseruola tonda con coperchio
Saucepot round with lid
Fleischtopf, rund mit Deckel
Brasière avec couvercle
Cacerola redonda con tapa

art.	ø cm.	lt.	col.
44201R12	12	0,55	●
44201V12	12	0,55	●
44201B12	12	0,55	●
44201O12	12	0,55	●
44201N12	12	0,55	●

Porzioni/Portion: 1 - Kg. 1,54.



Casseruola ovale con coperchio
Oval saucepan with lid
Ovaler Bratentopf mit Deckel
Casserole ovale avec couvercle
Cacerola oval con tapa

art.	dim. cm.	h.	lt.	col.
44202R12	12x9	6	0,42	●
44202V12	12x9	6	0,42	●
44202B12	12x9	6	0,42	●
44202O12	12x9	6	0,42	●
44202N12	12x9	6	0,42	●

Porzioni/Portion: 1 - Kg. 1,45.



Supporto legno
Wooden Stand
Holz-Träger
Support en bois
Soporte de madera

art.	ø cm.
44201-03	10



Supporto legno
Wooden Stand
Holz-Träger
Support en bois
Soporte de madera

art.	ø cm.
44201-01	10



Piatto legno
Wooden platter
Holzbrett
Planche en bois
Tabla de madera

art.	ø cm.
44201-10	10-12



Piatto legno
Wooden platter
Holzbrett
Planche en bois
Tabla de madera

art.	dim. cm.
44202-10	12x9



Coppa soufflé con piatto legno
Soufflé pot with wooden platter
Ramekin mit Holzbrett
Ramequin avec planche bois
Fuente soufflé con tabla madera

art.	ø cm.	lt.
44240S08	8	0,17

Porzioni/Portion: 1 - Kg. 0,57.



Casseruola alta con coperchio
Saucepot with lid
Fleischtopf mit Deckel
Brasière avec couvercle
Cacerola alta con tapa

art.	ø cm.	lt.	por.	kg.	col.
44201R16	16	1,0	1-2	2,64	●
44201N16	16	1,0	1-2	2,64	●
44201R20	20	2,6	2-3	4,34	●
44201N20	20	2,6	2-3	4,34	●
44201R24	24	4,5	4-5	5,76	●
44201N24	24	4,5	4-5	5,76	●
44201R28	28	6,7	6-8	7,79	●
44201N28	28	6,7	6-8	7,79	●
44201R32	32	10,0	12-16	9,61	●
44201N32	32	10,0	12-16	9,61	●



Casseruola alta coperchio vetro
Saucepot with glass lid
Fleischtopf mit Glasdeckel
Brasière avec couvercle verre
Cacerola alta con tapa vidrio

art.	ø cm.	lt.	por.	kg.	col.
44203R20	20	2,6	2-3	4,65	●
44203R24	24	4,5	4-5	4,95	●
44203R28	28	6,7	6-8	6,14	●



Casseruola ovale con coperchio
Oval saucepan with lid
Ovaler Bratentopf mit Deckel
Casserole ovale avec couvercle
Cacerola oval con tapa

art.	ø cm.	lt.	por.	kg.	col.
44202R25	25	3,3	4	5,44	●
44202N25	25	3,3	4	5,44	●
44202R27	27	4,0	4-6	5,88	●
44202N27	27	4,0	4-6	5,88	●
44202R29	29	4,8	6	6,78	●
44202N29	29	4,8	6	6,78	●



Casseruola bassa coperchio vetro
Casserole pot with glass lid
Bratentopf mit Glasdeckel
Sautoir avec couvercle verre
Cacerola baja con tapa vidrio

art.	ø cm.	lt.	por.	kg.	col.
44204R24	24	2,4	4	3,81	●
44204R28	28	3,4	4-6	5,08	●



Casseruola alta con coperchio vetro
Saucepan with glass lid
Stielkasserolle, hoch mit Glasdeckel
Casserole haute avec couvercle verre
Cazo recto alto con tapa vidrio

art.	ø cm.	lt.	por.	kg.	col.
44239R16	16	1	1-2	2,64	●



Padella
Frypan
Bratpfanne
Poêle
Sartén

art.	ø cm.	lt.	por.	kg.
44205-16	16	0,42	1	1,41
44205-20	20	0,80	1-2	1,97



Padella manico legno
Frypan wooden handle
Bratpfanne mit Holz-Griff
Poêle manche bois
Sartén mango madera

art.	ø cm.	lt.	por.	kg.	col.
44205-24	24	1,5	4	2,65	●
44205-28	28	2,5	4-6	3,69	●



Padella grill manico inox
Grill pan stainless steel handle
Grill-Pfanne mit Edelstahl-Griff
Poêle grill manche inox
Sartén grill mango inox

art.	ø cm.	lt.	por.	kg.
44211-22	22	0,8	1-2	1,40
44211-26	26	1,0	4	1,95
44211-30	30	1,2	4-6	2,55



Wok
Wok pan
Wok-Pfanne
Poêle chinoise
Wok

art.	ø cm.	lt.	por.	kg.
44247-38	38	5,3	4	4,86



Sottopentola legno, magnetico
Wooden platter with magnetic feature
Holzbrett, magnetisch
Planche en bois, magnétique
Tabla madera magnética

art.	ø cm.
44207-16	16
44207-20	20
44207-24	24
44207-28	28

GHISA SMALTATA ENAMELLED CAST IRON



Coprimaniglie silicone
Silicone sleeves
Silikon-Griffhüllen
Revêtement en silicone pour poignées
Cubre asas de silicona

art.	col.
44208G00	grigio/grey
44208R00	rosso/red



Padella grill
Grill pan
Grill-Pfanne
Poêle grill
Sartén grill

art.	dim. cm.	lt.	por.	kg.	col.
44209R26	26x26	2,2	4	3,63	●
44209R32	26x32	2,6	6	4,28	●



Padella grill
Grill pan
Grill-Pfanne
Poêle grill
Sartén grill

art.	dim. cm.	lt.	por.	kg.
44210-26	26x26	2,2	4	3,79
44210-32	26x32	2,75	6	4,50



Padella grill con supporto a servire legno
Grill pan with wooden service stand
Grill-Pfanne mit Service-Holzbrett
Poêle grill avec support à servir bois
Sartén grill con tabla madera

art.	dim. cm.	lt.	por.	kg.
44210S26	26x26	2,20	4	4,37
44210S32	26x32	2,75	6	5,17



Padella grill
Grill pan
Grill-Pfanne
Poêle grill
Sartén grill

art.	dim. cm.	lt.	por.	kg.
44210-42	31x42	4,5	8	5,46



Padella grill con supporto a servire legno
Grill pan with wooden service stand
Grill-Pfanne mit Service-Holzbrett
Poêle grill avec support à servir bois
Sartén grill con tabla madera

art.	dim. cm.	lt.	por.	kg.
44210S42	31x42	4,5	8	5,94



Padella grill quadra con supporto legno
Grill pan square and wooden platter
Grill-Pfanne, viereckig mit Holzbrett
Poêle grill carrée avec plache bois
Sartén grill cuadrada con tabla madera

art.	dim. cm.	por.	kg.
44215S16	16x16	1	1,64



Padella grill con supporto a servire legno
Grill pan and wooden service stand
Grill-Pfanne mit Service-Holzbrett
Poêle grill carrée avec plache à servir bois
Sartén grill cuadrada con tabla madera

art.	dim. cm.	por.	kg.
44216S16	16x16	1	2,15

Ciotoline non incluse. - Cups not included.



Griglia reversibile
Griddle plate, dual side, reversible
Grill-Platte, zweiseitig, reversible
Gril rectangle, reversible
Parrilla reversible

art.	dim. cm.	por.	kg.
44217-45	26x47	6-8	5,87



Padella grill
Grill pan
Grill-Pfanne
Poêle grill
Sartén grill

art.	ø cm.	lt.	por.	kg.
44212-30	30	2,35	4-6	3,63



Bistecchiera
Grill pan
Grill-Pfanne
Poêle grill
Sartén grill

art.	dim. cm.	por.	kg.
44213-24	24x24	1-2	1,80
44213-36	21x36	2,4	2,36



Bistecchiera
Grill pan
Grill-Pfanne
Poêle grill
Sartén grill

art.	ø cm.	por.	kg.
44214-25	25	2-3	1,65



Tegame rettangolare
Bake roasting dish
Pfanne, rechteckig
Plat rectangulaire
Rustidera

art.	dim. cm.	por.	kg.	col.
44218R30	22x30	6-8	3,1	●
44218R40	26x40	8-12	5,0	●



Terrina
Terrine pot
Pasteten-Pfanne
Terrine rectangle
Fuente rectangular

art.	dim. cm.	h.	por.	kg.	col.
44219R26	8,5x26,5	6	2-4	2,85	●



Piatto pesce con supporto legno
Fish plate with wooden platter
Fischplatte mit Holzbrett
Plat à poisson avec planche bois
Bandeja pescado con tabla madera

art.	dim. cm.	por.	kg.
44220S24	15x24	1-2	1,81



Piatto pesce con supporto legno
Fish plate with wooden platter
Fischplatte mit Holzbrett
Plat à poisson avec planche bois
Fuente pescado con tabla madera

art.	dim. cm.	por.	kg.
44221S30	15,5x29,5	1-2	1,98



Piatto pizza
Pizza pan
Pizza-Platte
Plat à pizza
Fuente para pizza

art.	ø cm.	por.	kg.
44222-20	20	1	1,99
44222-28	28	1	3,35



Piatto pizza con supporto legno
Pizza pan with wooden platter
Pizza-Platte mit Holzbrett
Plat à pizza avec planche bois
Fuente para pizza con tabla madera

art.	ø cm.	por.	kg.
44222S20	20	1	1,99
44222S28	28	1	3,35



Griglia reversibile
Griddle plate, dual side, reversible
Grill-Platte, zweiseitig, reversible
Grill rectangle, reversible
Parrilla reversible

art.	dim. cm.	por.	kg.
44224-22	22x15	1-2	2,24



Griglia reversibile con tagliere a servire legno
Grill plate and wooden service platter
Grill-Platte mit Service-Holzbrett
Grill avec plaque à servir bois
Parrilla con tabla madera

art.	dim. cm.	por.	kg.
44224S22	22x15	1-2	3,54



Barbecue da tavola
Table barbecue
Tischgrillplatte
Barbecue de table
Parrilla de mesa

art.	dim. cm.	por.	kg.
44225-22	22x15	1-2	4,44

Ciotoline non incluse. - Cups not included.

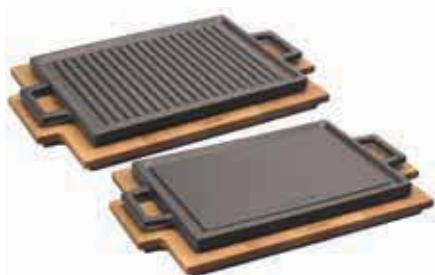

Griglia con supporto legno
Griddle with wooden platter
Grill-Platte mit Holzbrett
Grill rectangle avec planche bois
Parrilla con tabla madera

art.	dim. cm.	por.	kg.
44226S30	22x30	2-3	5,7



Barbecue da tavola
Table barbecue
Tischgrillplatte
Barbecue de table
Parrilla de mesa

art.	dim. cm.	por.	kg.
44227-30	22x30	2-3	5,94



Piatto fajita con supporto legno
Fajita plate with wooden platter
Fajitaplatte mit Holzbrett
Plat à fajitas avec planche bois
Fuente fajitas con tabla madera

art.	dim. cm.	por.	kg.
44228S23	17x23	1	2,04





Piatto fajita con supporto legno
Fajita plate with wooden platter
Fajitaplatte mit Holzbrett
Plat à fajitas avec planche bois
Fuente fajitas con tabla madera

art.	dim. cm.	por.	kg.
4229S20	10x20	1	1,67
Ciotoline non incluse. - Cups not included.			



Piatto ovale con supporto legno
Oval plate with wooden platter
Ovalplatte mit Holzbrett
Plat oval avec planche bois
Fuente ovale con tabla madera

art.	dim. cm.	h.	por.	kg.
44230S10	15x10	2,5	1	0,99
44230S14	21x14	2,5	1-2	1,58



Piatto ovale con supporto legno
Oval plate with wooden platter
Platte mit Holzbrett, oval
Plat oval avec planche bois
Fuente ovale con tabla madera

art.	dim. cm.	h.	por.	kg.
44231-14	21x14	2,5	1-2	2
Ciotoline non incluse. - Cups not included.				



Piatto tondo con supporto legno
Round plate with wooden platter
Platte mit Holzbrett, rund
Plat rond avec planche bois
Fuente redonda con tabla madera

art.	ø cm.	por.	kg.
44232S12	12	1	0,98
44232S16	16	1-2	1,39
44232S20	20	2-3	2,03



Piatto tondo con supporto legno
Round plate with wooden platter
Platte mit Holzbrett, rund
Plat rond avec planche bois
Fuente redonda con tabla madera

art.	ø cm.	lt.	por.	kg.
44233-16	16	0,46	1-2	1,74
44233-20	20	0,74	3-4	2,43
Ciotoline non incluse. - Cups not included.				



Padella tonda
Round pan
Pfanne, rund
Poêle ronde
Sartén grill redonda

art.	ø cm.	por.	kg.
44234-12	12	1	0,91
44234-16	16	1-2	1,27

GHISA SMALTATA ENAMELLED CAST IRON



Padella tonda con supporto legno
Round pan and wooden platter
Pfanne, rund mit Holzbrett
Poêle ronde avec plaque bois
Sartén grill redonda con tabla madera

art.	ø cm.	lt.	por.	kg.
44234S12	12	0,24	1	0,91
44234S16	16	0,45	1-2	1,27



Padella tonda con supporto legno
Round pan and wooden platter
Pfanne, rund mit Holzbrett
Poêle ronde avec plaque bois
Sartén grill redonda con tabla madera

art.	ø cm.	lt.	por.	kg.
44235-16	16	0,45	1-2	1,92

Ciotoline non include. - Cups not included.



Tegame con supporto a servire legno
Rectangular pan with wooden service stand
Pfanne mit Service-Holzbrett
Poêle avec support à servir bois
Sartén con tabla madera

art.	dim. cm.	por.	kg.
44237S15	12x15	1-2	1,29



Tegame con supporto a servire legno
Rectangular pan with wooden service stand
Pfanne mit Service-Holzbrett
Poêle avec support à servir bois
Sartén con tabla madera

art.	dim. cm.	por.	kg.
44238-15	12x15	1-2	1,59

Ciotoline non include. - Cups not included.



Ciotola tortillas, legno
Tortillas cup, wood
Tortillas-Schale, Holz
Coupe-tortillas, bois
Copa tortillas, madera

art.	ø cm.
44241-19	19



Coppa soufflè
Soufflé pot
Ramekin
Ramequin
Fuente soufflè

art.	ø cm.	lt.
44240-08	8	0,17



Coppa salsa, porcellana
Sauce bowl, porcelain
Saucentasse, Porzellan
Bol à sauce, porcelaine
Copa para salsa, porcelana

art.	ø cm.	h.
44242-00	6	4



Coppa salsa melamina
Sauce bowl, melamine
Saucentasse, Melamin
Bol à sauce, melamine
Copa para salsa, melamine

art.	ø cm.	h.
44243-00	6	3



Piatto con supporto legno
Oval plate with wooden platter
Ovalplatte mit Holzbrett
Plat oval avec planche bois
Fuente ovale con tabla madera

art.	dim. cm.
44223S19	12,5x19



Griglia reversibile con supporto legno
Griddle plate, reversible with wooden platter
Grill-Platte, reversible mit Holzbrett
Gril reversible avec planche bois
Plancha grill reversible con tabla madera

art.	ø cm.	por.	kg.
44236S28	28	4	5,0
44236S34	34	6	6,5



Piatto servire con supporto legno
Service dish with wooden stand
Servierplatte mit Holzbrett
Plat à servir avec support en bois
Plato para servir con tabla madera

art.	dim. cm.	por.	kg.
44245S32	32x20	1-2	2,24



Piatto servire con superficie porcellanata
Service dish with porcelain surface
Servierplatte mit Porzellan-Oberfläche
Plat à servir avec surface en porcelaine
Plato para servir con superficie porcelana

art.	dim. cm.	h. cm.	por.	kg.
44249S30	20x30	2,5	1-2	1,26
44249S35	25x35	2,5	1-2	1,71



Piatto servire con superficie porcellanata
Service dish with porcelain surface
Servierplatte mit Porzellan-Oberfläche
Plat à servir avec surface en porcelaine
Plato para servir con superficie porcelana

art.	ø cm.	por.	kg.
44250S30	30	1-2	0,93
44250S35	35	1-2	1,46



Rechaud, faggio/inossidabile
Plate warmer, beechwood & stainless steel
Rechaud, Buche u. Edelstahl
Réchaud, hêtre/inossidabile
Réchaud, madera/inossidabile

art.	dim. cm.	h. cm.	kg.
44251-01	16x16	2,5	0,66
44251-03	36x20	2,5	1,84



Piatto servire con superficie porcellanata
Service dish with porcelain surface
Servierplatte mit Porzellan-Oberfläche
Plat à servir avec surface en porcelaine
Plato para servir con superficie porcelana

art.	dim. cm.	h. cm.	por.	kg.
44255-10	39,5x25	2,5	1	3,02

Fornito con mini casseruola ø 10 cm con coperchio. 2 coppette salsa escluse.
Incl. mini casserole ø10 cm. with lid. 2 sauce cups not included.



Piatto servire con superficie porcellanata
Service dish with porcelain surface
Servierplatte mit Porzellan-Oberfläche
Plat à servir avec surface en porcelaine
Plato para servir con superficie porcelana

art.	dim. cm.	h. cm.	por.	kg.
44255-12	39,5x25	2,5	1	3,32

Fornito con mini casseruola ovale 12 cm con coperchio. 2 coppette salsa escluse.
Incl. mini oval casserole 12 cm. with lid. 2 sauce cups not included.



Piatto servire con superficie porcellanata
Service dish with porcelain surface
Servierplatte mit Porzellan-Oberfläche
Plat à servir avec surface en porcelaine
Plato para servir con superficie porcelana

art.	dim. cm.	h. cm.	por.	kg.
44255-14	39,5x25	2,5	1	2,48
44255-16	39,5x25	2,5	1-2	2,66

Fornito con padella ø 12 cm. o ø 16 cm. 2 coppette salsa escluse. - Incl. mini skillet ø 12 cm. or ø16 cm. 2 sauce cups not included.



Piatto servire con superficie porcellanata
Service dish with porcelain surface
Servierplatte mit Porzellan-Oberfläche
Plat à servir avec surface en porcelaine
Plato para servir con superficie porcelana

art.	dim. cm.	h. cm.	por.	kg.
44255-15	39,5x25	2,5	1-2	2,70

Fornito con tegamino 12x15 cm. 2 coppette salsa escluse. - Incl. mini dish 12x15 cm. 2 sauce cups not included.



Piatto servire con superficie porcellanata
Service dish with porcelain surface
Servierplatte mit Porzellan-Oberfläche
Plat à servir avec surface en porcelaine
Plato para servir con superficie porcelana

art.	dim. cm.	h. cm.	por.	kg.
44255-21	39,5x25	2,5	1-2	2,78

Fornito con tegamino 21x14 cm. 2 coppette salsa escluse. - Incl. mini dish 21x14 cm. 2 sauce cups not included.



Piatto servire con superficie porcellanata
Service dish with porcelain surface
Servierplatte mit Porzellan-Oberfläche
Plat à servir avec surface en porcelaine
Plato para servir con superficie porcelana

art.	dim. cm.	h. cm.	por.	kg.
44255-22	39,5x25	2,5	1-2	3,20

Fornito con tegamino ø 16 cm. 2 coppette salsa escluse. - Incl. mini pan ø16 cm. 2 sauce cups not included.

GHISA SMALTATA ENAMELLED CAST IRON



Piatto con supporto legno
Plate with wooden platter
Platte mit Holzbrett
Plat avec planche bois
Bandeja con tabla madera

N

art.	dim. cm.	lt.	por.	kg.
44220S32	32,5x17,5	0,38	1-2	2



Piatto con supporto legno
Plate with wooden platter
Platte mit Holzbrett
Plat avec planche bois
Bandeja con tabla madera

N

art.	dim. cm.	lt.	por.	kg.
44220S38	24,5x16,5	0,12	1	0,97



Tegame con supporto legno
Pan with wooden platter
Pfanne mit Holzbrett
Poêle avec plache bois
Paellera con tabla madera

N

art.	dim. cm.	Ø	lt.	por.	kg.
44247S16	23,5x18,5	16	0,44	1-2	1,24



Piatto servire con superficie porcellanata
Service dish with porcelain surface
Servierplatte mit Porzellan-Oberfläche
Plat à servir avec surface en porcelaine
Plato para servir con superficie porcelana

N

art.	dim. cm.	lt.	por.	kg.
44255-08	39,5x28x4,3	0,17	1	3,18

Fornito con piatto 16x25cm. 3 coppette salsa escluse. - Dish 16x25 cm. included. 3 sauce cups not included.



Tagliere
Wooden service platter
Holzbrett
Planche à Servir
Tabla madera

N

art.	dim. cm.	h.	por.	kg.
44258-60	60x15	1,8	4-6	0,87

Legno. - Wood: Iroko



Piatto servire con supporto legno
Service dish with wooden stand
Servierplatte mit Holzbrett
Plat à servir avec support en bois
Plato para servir con tabla madera

art.	dim. cm.	por.	kg.
44244S30	30x15	1-2	2,36
44244S36	36x24	4-6	4,53



Casseruola con supporto legno
Hot pot with wooden stand
Schüssel mit Holzbrett
Bol avec support en bois
Bol con tabla madera

art.	Ø cm.	h.	lt.	por.	kg.
44246S11	11	4	0,21	1	0,65
44246S14	14	4	0,32	1	1,00
44246S17	17	4	0,59	1	1,46



Piatto servire con superficie porcellanata
Service dish with porcelain surface
Servierplatte mit Porzellan-Oberfläche
Plat à servir avec surface en porcelaine
Plato para servir con superficie porcelana

art.	dim. cm.	h. cm.	por.	kg.
44248S60	60x15	2,5	4	1,62



Tagliere
Wooden Service Platter
Holzbrett
Planche À Servir
Tabla Madera

N

art.	Ø cm.	h.	por.	kg.
44259-29	29	2,5	1-2	1,01

Legno. - Wood: Iroko



Tagliere
Wooden Service Platter
Holzbrett
Planche À Servir
Tabla Madera

N

art.	dim. cm.	h.	por.	kg.
44264-35	25x35	1,8	1-2	0,92

Legno. - Wood: Iroko



Tagliere
Wooden Service Platter
Holzbrett
Planche À Servir
Tabla Madera

N

art.	dim. cm.	h.	por.	kg.
44265-35	25x35	1,8	1-2	0,77

Legno. - Wood: Iroko



Tagliere
Wooden service platter
Holzbrett
Planche à Servir
Tabla madera



art.	ø cm.	h.	por.	kg.
44254-30	31	2,5	1	1,75

Legno. - Wood: Iroko



Tagliere
Wooden service platter
Holzbrett
Planche à Servir
Tabla madera



art.	dim. cm.	h.	por.	kg.
44260-30	30x43	1,8	1-2	0,93
44260-34	34x47	1,8	2	1,18

Legno. - Wood: Iroko



Tagliere
Wooden service platter
Holzbrett
Planche à Servir
Tabla madera



art.	dim. cm.	h.	por.	kg.
44261-46	34x46	2,5	2	2,59

Legno. - Wood: Iroko



Tagliere
Wooden service platter
Holzbrett
Planche à Servir
Tabla madera



art.	dim. cm.	h.	por.	kg.
44262-42	26x42	2,5	1-2	0,88

Legno. - Wood: Iroko



Tagliere
Wooden service platter
Holzbrett
Planche à Servir
Tabla madera



art.	dim. cm.	h.	por.	kg.
44263-36	14x36	3,5	1-2	0,74

Legno. - Wood: Iroko



Porta coppetta singolo
Single souce pot wooden platter
Schale-Träger Einzel
Support à bol simple
Soporte copa individual



art.	dim. cm.	h.	ø	kg.
44256-01	8x11	1,8	5,5	0,08

Legno di faggio. Ciotolina non inclusa.
Beechwood. Cup not included.



Porta coppette doppio
Twice souce pot wooden platter
Schale-Träger doppel
Support à bol double
Soporte copa doble



art.	dim. cm.	h.	ø	kg.
44256-02	8x20	1,8	5,5	0,15

Legno di faggio. Ciotoline non incluse.
Beechwood. Cups not included.



Porta coppette triplo
Triple souce pot wooden platter
Schale-Träger dreifach
Support à bol triple
Soporte copa triple



art.	dim. cm.	h.	ø	kg.
44256-03	8x28	1,8	5,5	0,22

Legno di faggio. Ciotoline non incluse.
Beechwood. Cups not included.



Porta coppette quadruplo
Quartet souce pot wooden platter
Schale-Träger quad
Support à bol quadruple
Soporte copa cuatro veces



art.	dim. cm.	h.	ø	kg.
44256-04	8x36	1,8	5,5	0,29

Legno di faggio. Ciotoline non incluse.
Beechwood. Cups not included.



41200-09



44466-11



44466-14



44466-15



44846B05



44846-05



44466-07

PIROFILE FORNO OVEN COOKING DISHES

Porcellana utilizzabile in forni tradizionali e microonde,
non mettere le porcellane a diretto contatto con la fiamma

Only use in the oven or microwave oven, do not place them on direct flame





Ovale cordonata
Oval dish, fluted
Schale, oval, gerippt
Plat ovale, cannelé
Fuente oval borderizata

art.	dim. cm.	h.
44371-24	24x14	4,0
44371-28	28x16	4,5
44371-32	32,5x18	5,0
44371-36	36,5x19,5	5,0
44371-40	41x23	5,5
44371-44	44x26,5	5,7
44371-48	48x28,5	6,5



Rotonda cordonata
Round dish, fluted
Schale, rund, gerippt
Plat rond, cannelé
Fuente redonda borderizata

art.	Ø cm.	h.
44372-26	26,5	2,5
44372-32	32,0	4,0
44372-36	36,0	4,0
44372-40	40,0	4,0



Rettangolare cordonata
Rectangular dish, fluted
Schale, rechteckig, gerippt
Plat rectangulaire, cannelé
Fuente rectangular borderizata

art.	dim. cm.	h.
44374-22	22x16	6
44374-25	25x20	7
44374-32	32x22	6
44374-36	36x24	6
44374-40	40x26	6
44374-44	44x32	6



Ovale cordonata, alta
Oval dish, high, fluted
Schale, oval, gerippt
Plat oval, cannelé
Fuente oval borderizata, alta

art.	dim. cm.	h.
44389-32	32x22	8,5



Rettangolare cordonata, bassa
Rectangular dish, low, fluted
Schale, rechteckig, flach, gerippt
Plat rectangulaire, cannelé
Fuente rect. borderizata, baja

art.	dim. cm.	h.
44376-40	40x30	4



Quadra cordonata
Square dish, fluted
Schale, quadratisch, gerippt
Plat carré, cannelé
Fuente cuadrada borderizata

art.	dim. cm.	h.
44375-25	25x25	6



Tegamino cordonato
Egg dish, fluted
Schale, gerippt
Plat à oeufs, cannelé
Fuente huevo borderizata

art.	dim. cm.
44394-18	18x21,0
44394-21	21x24,5



Coppetta creme broulée
Crème broulée bowl
Crème broulée Schale
Coupelle broulée à crème
Bol creme broulée

art.	Ø cm.	h.
44391-12	11,6	3



Tegamino fondo, cordonato
Egg dish, high, fluted
Schale, tief, gerippt
Plat oeuf, creux, cannelé
Fuente huevo borderizata, alta

art.	dim. cm.
44395-18	18x20



Casseruola con coperchio
Soup bowl with cover
Kasserolle mit Deckel
Casserole avec couvercle
Cacerola con tapa

art.	dim. cm.	lt.
44397-18	14x18	0,5



Soufflè cordonato
Ramekin, fluted
Ramekin, gerippt
Ramequin, cannelé
Fuente soufflé borderizata

art.	Ø cm.	h.
44390-07	7	4,0
44390-09	9	4,5
44390-11	11	6,0















Soufflè cordonato
Ramekin, fluted
Ramekin, gerippt
Ramequin, cannelé
Fuente soufflé borderizata

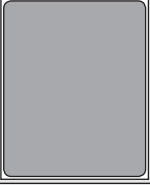



art.	Ø cm.	h.
44390-15	15	5,0
44390-18	18	7,5
44390-23	23	8,0

CONTENITORI GN - *FOOD PANS*

Inox, alluminio, policarbonato, polipropilene e porcellana

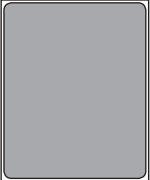





Stainless steel, aluminum, polycarbonate, polypropylene and porcelain

BACINELLE GASTRONORM, INOX FOOD PANS, STAINLESS STEEL							
	Serie Size	Profondità Depth mm.	lt.	Standard	Maniglie fisse Fixed handles	Maniglie interne Internal handles	Maniglie rientranti Retractable handles
	2/1 650x530 mm	20	-	14101-02			-
		40	-	14101-04			-
		65	19	14101-06			-
		100	31	14101-10			14151-10
		150	46	14101-15			14151-15
		200	56	14101-20			14151-20
	1/1 530x325 mm	20	-	14102-02	-	-	-
		40	-	14102-04	-	-	-
		65	9	14102-06	-	-	14152-06
		100	14	14102-10	14112-10	14142-10	14152-10
		150	21	14102-15	14112-15	14142-15	14152-15
		200	28	14102-20	14112-20	14142-20	14152-20
	2/3 353x320 mm	20	-	14103-02			
		40	-	14103-04			
		65	5,5	14103-06			
		100	9,0	14103-10			
		150	13,0	14103-15			
		200	18,0	14103-20			
	2/4 162x530 mm	65	4,0	14104-06			
		100	5,6	14104-10			
		150	8,7	14104-15			
	1/2 325x265 mm	20	-	14105-02	-	-	-
		40	-	14105-04	-	-	-
		65	4,0	14105-06	-	-	-
		100	6,5	14105-10	14115-10	14145-10	14155-10
		150	9,5	14105-15	14115-15	14145-15	14155-15
		200	12,5	14105-20	14115-20	14145-20	14155-20
	1/3 325x180 mm	65	2,5	14107-06	-	-	-
		100	4,0	14107-10	14117-10	14147-10	14157-10
		150	5,7	14107-15	14117-15	14147-15	14157-15
		200	7,8	14107-20	14117-20	14147-20	14157-20
	1/4 265x160 mm	65	1,8	14108-06	-	-	-
		100	2,8	14108-10	14118-10	14148-10	14158-10
		150	4,0	14108-15	14118-15	14148-15	14158-15
		200	5,5	14108-20	14118-20	14148-20	14158-20
	1/6 176x160 mm	65	1,0	14109-06	-		-
		100	1,6	14109-10	14119-10		14159-10
		150	2,4	14109-15	14119-15		14159-15
		200	3,4	14109-20	-		14159-20
	1/9 176x110 mm	65	0,6	14110-06			
		100	1,0	14110-10			

INOX - STAINLESS STEEL BACINELLE GASTRONORM FORATE PERFORATED FOOD PANS					
	Serie Size	Profondità Depth mm.	lt.	Standard	Maniglie snodate Folding handles
	2/1 650x530 mm	20 40 65 100 150 200	- - - - - -	14201-02 14201-04 14201-06 14201-10 14201-15 14201-20	
	1/1 530x325 mm	20 40 65 100 150 200	- - - - - -	14202-02 14202-04 14202-06 14202-10 14202-15 14202-20	- - 14252-06 14252-10 14252-15 14252-20
	2/3 353x320 mm	65 100 150 200	- - - -	14203-06 14203-10 14203-15 14203-20	
	1/2 325x265 mm	20 40 65 100 150 200	- - - - - -	14205-02 14205-04 14205-06 14205-10 14205-15 14205-20	- - 14255-06 14255-10 14255-15 14255-20

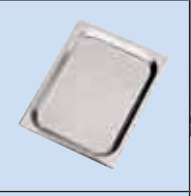
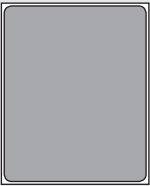
Bacinelle profondità mm 20 e 40 forate solo sul fondo. - Containers depth mm 20 and 40 only bottom perforated.



TEGLIE/BACINELLE <i>BAKING SHEETS/PANS</i>			 PFOA free		 PFOA free		 PFOA free
	Serie Size	Profondità Depth mm.	Bacinella inox antiaderente S/S non stick pan	Teglia inox S/S baking pan	Teglia inox antiaderente S/S non stick baking pan	Teglia alluminio Aluminium baking pan	Teglia alluminio antiaderente Aluminium non stick baking pan
	2/1 650x530 mm	20 40 65		14301-02 14301-04 14301-06			
	1/1 530x325 mm	20 40 65	14162-02 14162-04 14162-06	14302-02 14302-04 14302-06	14362-02 14362-04 14362-06	16302-02 16302-04 16302-06	16362-02 16362-04 16362-06
	2/3 353x320 mm	20 40 65		14303-02 14303-04 14303-06		16303-02 16303-04 16303-06	16363-02 16363-04 16363-06
	1/2 325x265 mm	20 40 65	14165-02 14165-04 14165-06	14305-02 14305-04 14305-06	14365-02 14365-04 14365-06	16305-02 16305-04 16305-06	16365-02 16365-04 16365-06

COPERCHI GN <i>LIDS</i>						
Serie Size	Standard	Maniglie Handles	Mestolo Ladle	Maniglie + mestolo Handles + ladle	Guarnizione Trimming	Guarnizione + maniglie Trimming + handles
1/1 530x325 mm	14502-00	14512-00	14522-00	14532-00	14542-00	14552-00
2/3 353x320 mm	14503-00	-	14523-00	-	14543-00	-
2/4 162x530 mm	14504-00	-	-	-	-	-
1/2 325x265 mm	14505-00	14515-00	14525-00	14535-00	14545-00	14555-00
1/3 325x180 mm	14507-00	14517-00	14527-00	14537-00	14547-00	14557-00
1/4 265x160 mm	14508-00	14518-00	14528-00	14538-00	14548-00	14558-00
1/6 176x160 mm	14509-00	14519-00	14529-00	14539-00	14549-00	14559-00
1/9 176x110 mm	14510-00	-	-	-	-	-



Falso fondo forato
Drainer plate
Abtropfplatte
Plateau double fond perforé
Fondo perforado

art.	mod./size
14402-00	1/1
14405-00	1/2
14407-00	1/3



Separatore
Adaptor bar
Stege
Barrette de composition
Perfiles divisorios

art.	mod./size	l. mm.
14409-01	1/1	325
14409-02	2/1	530



Teglia GN 1/1 smaltata
GN 1/1 pan, enamelled
GN 1/1-Ofenblech, emalliert
Bac GN 1/1 émaillé
Cubeta GN 1/1, esmaltada

art.	dim. cm.	h.	lt.
44322-02	53x32,5	2,0	2,5
44322-04	53x32,5	4,0	5,0
44322-06	53x32,5	6,5	9,0

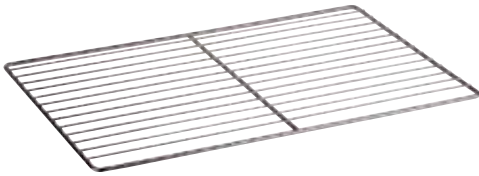

Griglia in filo, inox
Wire grid, stainless steel
Gastronormrost, Edelstahl Rostfrei
Grille, inox
Rejilla, inox

art.	mod./size
44421-00	2/1
44422-00	1/1
44412-00	1/2
44423-00	2/3

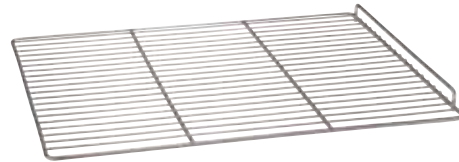

Griglia in filo con sponda, inox
Wire grid with edge, stainless steel
Gastronormrost mit Seitenwand, Edelstahl Rostfrei
Grille avec arrêt, inox
Rejilla con borde, inox

art.	mod./size	h. cm.
44432-21	2/1	3



Cesta per friggere, inox
Fry basket, stainless steel
Frittier-Korb, Edelstahl Rostfrei
Panier à frire, inox
Cesta escurrefrito, inox

art.	mod./size	dim. cm.	h.
11750-11	1/1	53x32,5	6

Cesta per friggere da forno, consente di cuocere in pochi minuti e senza grassi grandi quantità di cibi prefritti. La costruzione in filo consente al calore di cuocere facilmente garantendo una doratura uniforme. Una soluzione salutare che permette di eliminare i costi d'acquisto, conservazione e smaltimento degli oli e dei grassi.

This stainless steel oven fry basket is primarily used for cooking fried products in a convection oven. The wire construction allows the oven's dry heat to cook food easily and provides an evenly-browned and crispy finish to foods such as French fries. The basket's size makes it easy to cook large quantities at a time. This healthy alternative to deep-frying also saves space and costs, as it eliminates the need to purchase, store and dispose of oils.



Griglia smaltata
Grid enamelled
Rost, emalliert
Grille émaillé
Rejilla esmaltada

art.	mod./size	dim. cm.
11760-11	1/1	53x32,5











La grigliatura degli alimenti è uno dei metodi di cottura più antichi: è semplice, veloce e dona alle pietanze un sapore caratteristico, ottimale per tutte le preparazioni, carne, pesce e verdure. Ideale per le preparazioni in grande quantità per catering e nella banchettistica, party/feste open-air. Quando la carne viene posta sulla griglia, il calore accumulato fa sì che i pori si chiudano immediatamente, garantendo così una perdita di succhi e peso molto limitata.

Grilling food is one of the oldest methods of cooking, simple and fast it gives a distinctive flavour to dishes, suitable for all preparations, whether meat, fish or vegetables. Ideal for preparation in large quantities for catering and banquets, meals/open-air festivals. When the meat is placed on the grid, the heat stored immediately closes the pores, thus guaranteeing a very poor loss of juice and weight.

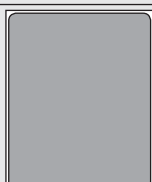
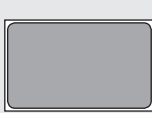

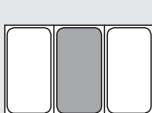
In policarbonato, trasparente ed infrangibile. La superficie liscia dell'interno facilita la pulizia. Resistenti alle macchie, non attaccabili dagli acidi dei cibi, da oli o da alcol. Termoresistenti da -40°C a +100°C. Con scala graduata in litri. Impilabili, sono ideali per la conservazione, trasporto ed esposizione.

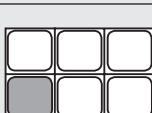









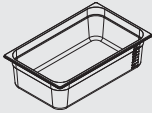

Polycarbonate, clear and unbreakable. Smooth surface is easy to clean. Stain resistant, not harmed by food acids, oils or alcohol. Temperature range: -40°C to + 100°C. With metric graduation. Stackable, ideal for storage, transportation and serving display.

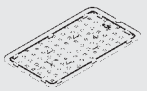
POLICARBONATO POLYCARBONATE BACINELLE GASTRONORM GN FOOD PANS							
	Serie Size	Profondità Depth mm.	lt.	Bacinella Pan	Coperchio Lid	Coperchio con silicone Lid silicone sealing	Griglia Grid
	2/1 650x530 mm	150 200	42 52	14561-15 14561-20	14571-00 Senza traversino No handle		14591-00
	1/1 530x325 mm	65 100 150 200	8,5 13,0 19,5 26,0	14562-06 14562-10 14562-15 14562-20	14572-00		14592-00
	1/2 325x265 mm	65 100 150 200	3,9 5,9 8,9 11,8	14565-06 14565-10 14565-15 14565-20	14575-00	14585-00	14595-00
	1/3 325x180 mm	65 100 150 200	2,4 3,6 5,3 7,0	14567-06 14567-10 14567-15 14567-20	14577-00		14597-00
	1/4 265x160 mm	65 100 150 200	1,7 2,5 3,7 5,5	14568-06 14568-10 14568-15 14568-20	14578-00		14598-00
	1/6 176x160 mm	65 100 150 200	1,0 1,5 2,2 3,4	14569-06 14569-10 14569-15 14569-20	14579-00		14599-00
	1/9 176x110 mm	65 100	0,6 1,0	14570-06 14570-10	14580-00		



Realizzati con materiali approvati FDA. Studiati e realizzati in ottemperanza alla normativa UNI EN 631-1. Ottima resistenza agli urti. Eccellente trasparenza (0,6 HAZE). Pareti completamente lisce per permettere di identificare facilmente il contenuto e per agevolare il lavaggio. Dotati di scala graduata sia secondo sistema metrico che americano. Gradino di sovrapposibilità che consente agevole impilaggio. Utilizzabili nel microonde ma non per tempi prolungati. Sopportano temperature da -40°C a +110°C. Fondo esternamente foto-inciso anti graffio. AVVERTENZE - I contenitori in polycarbonato non sono raccomandati per l'uso su tavole a vapore; evitare il contatto con sapone di Marsiglia. Per il lavaggio si consiglia l'utilizzo di detersivi con PH neutro e, in ogni caso, con PH inferiore a 11. L'utilizzo di detersivi fortemente alcalini (PH>11) o a base di alcool, solventi clorurati, ammoniacca e l'impiego di spugne abrasive potrebbe danneggiare irrimediabilmente i prodotti.

Made with FDA approved materials. Designed and manufactured in compliance with UNI EN 631-1. Excellent resistance to shocks. Excellent transparency (HAZE 0.6). Walls completely smooth to allow easy identification of content and easy cleaning. Graduated scale according to both metric and American system. Nest for easy storage. Can be used in microwave ovens but not for prolonged times. Withstands temperatures from -40°C to +110°C. External bottom photo-etched anti-scratch. **WARNING** - Polycarbonate containers are not recommended for use on steam tables, avoid contact with soap. For cleaning we recommend detergents with neutral pH and, in any case, with a pH less than 11. The use of detergents strongly alkaline (pH>11) or alcohol, chlorinated solvents, ammonia and abrasive pads may irreparably damage the product







POLICARBONATO POLYCARBONATE BACINELLE GASTRONORM GN FOOD PANS								
	Serie Size	Profondità Depth mm.	lt.	Bacinella Pan	Coperchio Lid	Coperchio ermetico Hermetic lid	Mestolo Ladle	Falso fondo Drainer
	2/1 650x530 mm	200	55,5	14801-20	14811-00		14821-00	14851-00
	1/1 530x325 mm	65 100 150 200	9,0 13,3 20,0 26,4	14802-06 14802-10 14802-15 14802-20	14812-00	14832-00	14822-00	14852-00
	1/2 325x265 mm	65 100 150 200	4,0 6,1 9,0 11,9	14805-06 14805-10 14805-15 14805-20	14815-00	14835-00	14825-00	14855-00
	1/3 325x175 mm	65 100 150 200	2,5 3,8 5,5 7,1	14807-06 14807-10 14807-15 14807-20	14817-00	14837-00	14827-00	
	1/4 264x162 mm	65 100 150 200	1,7 2,6 3,8 4,8	14808-06 14808-10 14808-15 14808-20	14818-00	14838-00	14828-00	
	1/6 176x162 mm	65 100 150 200	1,0 1,6 2,3 2,8	14809-06 14809-10 14809-15 14809-20	14819-00	14839-00	14829-00	
	1/9 176x108 mm	65 100	0,6 0,9	14810-06 14810-10	14820-00	14840-00	14830-00	

I coperchi della serie 14800 polycarbonato e 14600 Tritan sono intercambiabili.
Coperchi ermetici, NON a tenuta stagna.

The lids of the series 14800 polycarbonate and 14600 Tritan are interchangeable.
Hermetic lids, NOT water-tight.



BACINELLE GASTRONORM, TRITAN - GN FOOD PANS, TRITAN
COPOLIMERO - COPOLYMER - BPA FREE -40°C+90°C

	Serie Size	Profondità Depth mm.	lt.	Bacinella Pan	Coperchio Lid	Coperchio ermetico Hermetic lid	Falso fondo Drainer
	2/1 650x530 mm	200	55,5	14661-20	14671-00		14691-00
	1/1 530x325 mm	65 100 150 200	9,0 13,3 20,0 26,4	14662-06 14662-10 14662-15 14662-20	14672-00	14682-00	14692-00
	1/2 325x265 mm	65 100 150 200	4,0 6,1 9,0 11,9	14665-06 14665-10 14665-15 14665-20	14675-00	14685-00	14695-00
	1/3 325x175 mm	65 100 150 200	2,5 3,8 5,5 7,1	14667-06 14667-10 14667-15 14667-20	14677-00	14687-00	
	1/4 264x162 mm	65 100 150 200	1,7 2,6 3,8 4,8	14668-06 14668-10 14668-15 14668-20	14678-00	14688-00	
	1/6 176x162 mm	65 100 150 200	1,0 1,6 2,3 2,8	14669-06 14669-10 14669-15 14669-20	14679-00	14689-00	
	1/9 176x108 mm	65 100	0,6 0,9	14670-06 14670-10	14680-00	14690-00	

I coperchi della serie 14800 policarbonato e 14600 Tritan sono intercambiabili.
Coperchi ermetici, NON a tenuta stagna.

The lids of the series 14800 polycarbonate and 14600 Tritan are interchangeable.
Hermetic lids, NOT water-tight.



Traslucide e resistenti, impilabili, leggere e maneggevoli. Realizzate in polipropilene alimentare, conformi alle normative alimentari internazionali. Non si impregnano di odori e sapori. Lavabili a mano o in lavastoviglie con normali detersivi. Non utilizzare pagliette d'acciaio o ruvide, evitare l'uso di sostanze abrasive. Termoresistenti da -40°C a +75°C. Scala di graduazione in litri per un controllo istantaneo della quantità. Coperchio resistente per una perfetta chiusura stagna. Utilizzabili per la refrigerazione, lo stoccaggio, trasporto, esposizione e distribuzione di tutti i tipi di alimenti.













Made in polypropylene, full compliance with food contact sanitation requirements, light, odourless, transparent, dish-washer safe, unbreakable. Cold resistant up to -40°C - Heat resistant up to +75°C. Easily cleanable, designed to allow for nesting empty containers within one another and stacking bottoms a top of lids. Provided with metric graduation. Lids tightly fitting. Ideal for commercial food processing and handling facilities. Can be used in all public places where food is prepared, hot/cold stored or served, for holding and display.

POLIPROPILENE POLYPROPYLENE BACINELLE GASTRONORM FOOD PANS										
	Serie Size	Profondità Depth mm.	lt.	Bacinella Pan	Griglia Grid	Coperchio - Lid Neutro - Clear	Coperchio - Lid Blu - Blue	Coperchio - Lid Rosso - Red	Coperchio - Lid Giallo - Yellow	Coperchio - Lid Verde - Green
	1/1 530x325 mm	65 100 150 200	8,5 13,0 19,5 26,0	14702-06 14702-10 14702-15 14702-20	14712-00	14722-99	14722-00	14722-11	14722-22	14722-33
	1/2 325x265 mm	65 100 150 200	3,9 5,9 8,9 11,8	14705-06 14705-10 14705-15 14705-20	14715-00	14725-99	14725-00	14725-11	14725-22	14725-33
	1/3 325x180 mm	65 100 150 200	2,4 3,6 5,3 7,0	14707-06 14707-10 14707-15 14707-20	14717-00	14727-99	14727-00	14727-11	14727-22	14727-33
	1/4 265x160 mm	65 100 150 200	1,7 2,5 3,7 5,5	14708-06 14708-10 14708-15 14708-20	14718-00	14728-99	14728-00	14728-11	14728-22	14728-33
	1/6 176x160 mm	65 100 150 200	1,0 1,5 2,2 3,4	14709-06 14709-10 14709-15 14709-20	14719-00	14729-99	14729-00	14729-11	14729-22	14729-33
	1/9 176x110 mm	65 100	1,3 0,8	14710-06 14710-10		14730-99	14730-00	14730-11	14730-22	14730-33



Realizzati con materiali approvati FDA. Eccellente soluzione economica per la preparazione, esposizione e conservazione dei cibi. Ottima resistenza agli urti a temperatura ambiente. Buona trasparenza che permette di identificare facilmente il contenuto al proprio interno. Sopportano temperature da -40°C a +80°C. Dotati di scala graduata sia secondo sistema metrico che americano. Gradino di sovrapposibilità che consente agevole impilaggio. Disponibili con coperchi ermetici trasparenti o colorati. **AVVERTENZE:** i contenitori in polipropilene non sono indicati per l'uso su tavole a vapore.

Made with FDA approved materials. Excellent economical solution for the preparation, display and storage of foods. Excellent impact resistance at room temperature. Good transparency that allows to easily identify the contents. Withstands temperatures from -40°C to +80°C. With both metric and American graduated scale. Nest for easy storage. Available clear or colored airtight lids. **WARNING:** polypropylene containers are not suitable for use on steam tables.

POLIPROPILENE POLYPROPYLENE BACINELLE GASTRONORM FOOD PANS										
	Serie Size	Profondità Depth mm.	lt.	Bacinella Pan	Falso fondo Drainer plate	Coperchio ermetico Hermetic Lid Neutro - Clear	Coperchio ermetico Hermetic Lid Blu - Blue	Coperchio ermetico Hermetic Lid Rosso - Red	Coperchio ermetico Hermetic Lid Giallo - Yellow	Coperchio ermetico Hermetic Lid Verde - Green
	1/1 530x325 mm	65 100 150 200	9,0 13,3 20,0 26,4	14902-06 14902-10 14902-15 14902-20	14912-00	14922-99	14922-00	14922-11	14922-22	14922-33
	1/2 325x265 mm	65 100 150 200	4,0 6,1 9,0 11,9	14905-06 14905-10 14905-15 14905-20	14915-00	14925-99	14925-00	14925-11	14925-22	14925-33
	1/3 325x175 mm	65 100 150 200	2,5 3,8 5,5 7,1	14907-06 14907-10 14907-15 14907-20		14927-99	14927-00	14927-11	14927-22	14927-33
	1/4 264x162 mm	65 100 150 200	1,7 2,6 3,8 4,8	14908-06 14908-10 14908-15 14908-20		14928-99	14928-00	14928-11	14928-22	14928-33
	1/6 176x162 mm	65 100 150 200	1,0 1,6 2,3 2,8	14909-06 14909-10 14909-15 14909-20		14929-99	14929-00	14929-11	14929-22	14929-33
	1/9 176x108 mm	65 100	0,6 0,9	14910-06 14910-10		14930-99	14930-00	14930-11	14930-22	14930-33

I coperchi della serie 14900 polipropilene e 15100 polipropilene IML sono intercambiabili. Coperchi ermetici, NON a tenuta stagna.

The lids of the series 14900 polypropylene and 15100 polypropylene IML are interchangeable. Hermetic lids, NOT water-tight.

Realizzati con materiali approvati FDA. Con etichetta permanente grazie alla tecnologia IML che consente di avere un'etichetta costampata, niente più etichette adesive che tendono a lasciare residui appiccicosi richiedendo poi operazioni di raschiatura. I contenitori in polipropilene IML aiutano a garantire la sicurezza e l'igiene degli alimenti secondo la normativa HACCP. Sono disponibili sia con coperchi colorati che con coperchi trasparenti con sede per COLOR CLIPS per evitare la contaminazione tra i vari alimenti. Per scrivere sull'etichetta è disponibile un pennarello specifico che viene rimosso con il semplice lavaggio in lavastoviglie. Ottima resistenza agli urti a temperatura ambiente. Buona trasparenza che permette di identificare facilmente il contenuto al proprio interno. Sopportano temperature da -40°C a +80°C. Dotati di scala graduata sia secondo sistema metrico che americano. Gradino di sovrapposibilità che consente agevole impilaggio.

AVVERTENZE: i contenitori in polipropilene non sono indicati per l'uso su tavole a vapore.
Made with FDA approved materials. With permanent label thanks to the IML technology that allows you to obtain an in molded label. No more labels that leave sticky residue requiring scraping operations. The IML polypropylene containers help ensure the safety and hygiene of food according to HACCP standards. They are available with colored lids or transparent lids with COLOR CLIPS to prevent contamination between different foods. To write on the label there is a specific marker that can be removed by simply washing in the dishwasher. Excellent impact resistance at room temperature. Good transparency that allows you to easily identify the contents. Withstands temperatures from -40°C to +80°C. With both metric and American graduated scale. Nest for easy storage. WARNING: polypropylene containers are not suitable for use on steam tables.



**POLIPROPILENE
POLYPROPYLENE
BACINELLE GASTRONORM
FOOD PANS**



	Serie Size	Profondità Depth mm.	lt.			Coperchio ermetico	Coperchio ermetico	Coperchio ermetico	Coperchio ermetico	Coperchio ermetico
				Bacinella Pan	Falso fondo Drainer plate	Hermetic Lid Neutro - Clear	Hermetic Lid Blu - Blue	Hermetic Lid Rosso - Red	Hermetic Lid Giallo - Yellow	Hermetic Lid Verde - Green
	1/1 530x325 mm	65 100 150 200	9,0 13,3 20,0 26,4	15101-06 15101-10 15101-15 15101-20	14912-00	14922-99	14922-00	14922-11	14922-22	14922-33
	1/2 325x265 mm	65 100 150 200	4,0 6,1 9,0 11,9	15105-06 15105-10 15105-15 15105-20	14915-00	14925-99	14925-00	14925-11	14925-22	14925-33
	1/3 325x175 mm	65 100 150 200	2,5 3,8 5,5 7,1	15107-06 15107-10 15107-15 15107-20		14927-99	14927-00	14927-11	14927-22	14927-33
	1/4 264x162 mm	65 100 150 200	1,7 2,6 3,8 4,8	15108-06 15108-10 15108-15 15108-20		14928-99	14928-00	14928-11	14928-22	14928-33
	1/6 176x162 mm	65 100 150 200	1,0 1,6 2,3 2,8	15109-06 15109-10 15109-15 15109-20		14929-99	14929-00	14929-11	14929-22	14929-33
	1/9 176x108 mm	65 100	0,6 0,9	15110-06 15110-10		14930-99	14930-00	14930-11	14930-22	14930-33









**ACCESSORI
ACCESSORIES**







Clips Giallo - Yellow	Clips Blu - Blue	Clips Rosso - Red	Clips Verde - Green	Set 2 pennarelli Kit 2 markers
15100-01	15100-02	15100-03	15100-04	15100-AA
u. pack 12 pz/pcs	u. pack 12 pz/pcs	u. pack 12 pz/pcs	u. pack 12 pz/pcs	u. pack 2 pz/pcs

I coperchi della serie 14900 polipropilene e 15100 polipropilene IML sono intercambiabili. Coperchi ermetici, NON a tenuta stagna.

The lids of the series 14900 polypropylene and 15100 polypropylene IML are interchangeable. Hermetic lids, NOT water-tight.









 BACINELLE GN - FOOD PANS	Serie Size HIGH-LINE	Profondità Depth mm.	lt.	Bacinella Pan
	1/1 530x325 mm	65 100	7,10 11,00	44883-11 44879-11
	2/3 350x325 mm	65	4,60	44883-23
	2/4 160x530 mm	65	3,00	44883-24
	1/2 325x265 mm	65 100	3,40 5,50	44883-12 44879-12
	1/3 325x175 mm	65 100	2,00 3,15	44883-13 44879-13
	1/4 265x160 mm	65 100	1,35 2,20	44883-14 44879-14
	1/6 175x160 mm	65 100	0,80 1,25	44883-16 44879-16

 BACINELLE GN - FOOD PANS	Serie Size ECO-LINE	Profondità Depth mm.	lt.	Coperchio Lid PC	Bacinella Pan ●	Bacinella Pan ○
	1/1 530x325 mm	65 100	7,10 10,60	44818-11	44878-11 44878B11	44877-11 44877B11
	2/4 160x530 mm	65 100	3,00 4,30		44878-24 44878B24	44877-24 44877B24
	1/2 325x265 mm	65 100	3,40 4,70	44818-12	44878-12 44878B12	44877-12 44877B12
	1/3 325x175 mm	65 100	2,00 2,70	44818-13	44878-13 44878B13	44877-13 44877B13
	1/4 265x160 mm	65 100	1,35 1,90	44818-14	44878-14 44878B14	44877-14 44877B14
	1/6 175x160 mm	65 100	0,80 1,00	44818-16	44878-16 44878B16	44877-16 44877B16



GN PORCELLANA <i>PORCELAIN FOOD PANS</i>	Serie Size	Profondità Depth mm.	Bacinella bianca White pan		Bacinella nera Black pan
	1/1 530x325 mm	20 65	44332-03 44332-06		44332B06
	2/3 353x320 mm	20 65	44333-03 44333-06		44333B06
	2/4 162x530 mm	20 65	44334-03 44334-06		
	1/2 325x265 mm	20 65	44335-03 44335-06		44335B06
	1/3 325x175 mm	20 65	44337-03 44337-06		44337B06
	1/4 265x160 mm	20 65	44338-03 44338-06		
	1/6 176x160 mm	20 65	44339-03 44339-06		



GN PORCELLANA INDUZIONE N PORCELAIN FOOD PANS	Serie Size	Profondità Depth mm.	Standard full color	Induction full color
	1/1 530x325 mm	65	44382A06 ● 44382B06 ● 44382G06 ● 44382O06 ● 44382Y06 ●	44342-06 ○ 44312A06 ● 44312B06 ● 44312G06 ● 44312O06 ● 44312R06 ● 44312Y06 ●
	2/3 350x320 mm	65	44383O06 ● 44383Y06 ●	44343-06 ○ 44313B06 ● 44313G06 ● 44313O06 ● 44313R06 ● 44313Y06 ●
	2/4 162x530 mm	65	44384A06 ● 44384O06 ● 44384R06 ● 44384Y06 ●	44344-06 ○ 44314A06 ● 44314B06 ● 44314G06 ● 44314O06 ● 44314R06 ● 44314Y06 ●
	1/2 325x265 mm	65	44385A06 ● 44385B06 ● 44385G06 ● 44385O06 ● 44385R06 ● 44385Y06 ●	44345-06 ○ 44315A06 ● 44315B06 ● 44315G06 ● 44315O06 ● 44315R06 ● 44315Y06 ●
	1/4 265x162 mm	65		44346-06 ○
	1/3 325x176 mm	65	44387A06 ● 44387B06 ● 44387G06 ● 44387O06 ● 44387R06 ● 44387Y06 ●	44347-06 ○ 44317A06 ● 44317B06 ● 44317G06 ● 44317O06 ● 44317R06 ● 44317Y06 ●

KITCHEN UTENSILS

UTENSILI DA CUCINA
KITCHEN UTENSILS
KÜCHENZUBEHÖRE
USTENSILES DE CUISINE
UTENSILIOS DE COCINA

P SERIE 12900 **PA+[®]**
plus

Un'ampia gamma di utensili professionali per la cucina in materiale composito, poliammide (nylon 6.6) con fibra di vetro. Lavabili in lavastoviglie, sterilizzabili, resistenti fino a 220°C. Ideali per l'uso con antiaderenti.

A wide range of professional kitchen utensils in composite material, polyamide (nylon 6.6) with fiberglass. Dishwasher safe, can be sterilized, heat resistant up to 220°C. Safe for non-stick cookware.



Cucchiaione
Spoon
Löffel
Mouvette
Cuchara

PA+[®]
plus

art.	l. cm.
12903-30	30
12903-40	38
12903-45	45



Spatola
Spatula
Teigschäber
Spatule
Espátula

PA+[®]
plus

art.	l. cm.
12905-25	25
12905-30	30
12905-35	35
12905-40	40
12905-45	45
12905-50	50



Spatola per stemperare
Stirring ladle
Rühr-u. Temperierlöffel
Spatule à délayer
Espátula para diluir

PA+[®]
plus

art.	l. cm.
12907-07	35
12907-08	35



Spatola
Spatula
Stielschäber
Spatule
Espátula

PA+
plus

art.	l. cm.
12915-25	25
12915-26	28
12915-35	35
12915-45	45



Spatola
Spatula
Teigschäber
Spatule
Espátula

PA+
plus

art.	l. cm.
12916-25	25
12916-33	33



Spatola triangolare
Spatula
Dreieck-Stielschäber
Spatule trilon
Espátula triangular

PA+
plus

art.	l. cm.
12917-25	25



Spatola smussata
Bevelled spatula
Teigschäber
Spatule plate biseautée
Espátula blanda

PA+
plus

art.	l. cm.
12906-35	35



Spatola
Spatula
Teigschäber
Spatule
Espátula

PA+
plus

art.	l. cm.
12908-30	30
12908-35	35
12908-40	40



Paletta angolare
Angular spatula
Winkelpalette
Spatule angulaire
Espátula

PA+
plus

art.	l. cm.
12909-12	12
12909-23	23



Paletta forata
Spatula, perforated
Teigschäber, perforiert
Spatule ajourée
Espátula perforada

PA+
plus

art.	l. cm.
12921-01	30



Paletta forata
Spatula, perforated
Teigschäber, perforiert
Spatule ajourée
Espátula perforada

PA+
plus

art.	l. cm.
12921-05	30



Paletta
Spatula
Teigschäber
Spatule
Espátula

PA+
plus

art.	l. cm.
12921-10	32



Paletta fritti
Fish & chips spatula
Fischeber
Pelle à friture
Espátula fritura

PA+
plus

art.	l. cm.
12921-15	35



Mestolo
Ladle
Schöpflöffel
Louche
Cacillo

PA+
plus

art.	ø cm.	l.
12920-01	9	31



Schiumarola
Skimmer
Schaumlöffel
Ecumoire
Espumadera

PA+
plus

art.	ø cm.	l.
12920-05	11	35



Paletta
Spatula
Teigschäber
Spatule
Espátula

PA+
plus

art. dim. cm. l.
12920-10 9x10 35



Paletta fritti
Fish & chips spatula
Fischheber
Pelle à friture
Espátula fritura

PA+
plus

art. dim. cm. l.
12920-11 9x10 35



Cucchiaione
Spoon
Giesslöffel
Cuillère
Cucharón

PA+
plus

art. l. cm.
12920-15 35



Cucchiaione forato
Perforated spoon
Giesslöffel, perforiert
Cuillère perforée
Cucharón perforado

PA+
plus

art. l. cm.
12920-16 35



Molla insalata
Salad tong
Salatzange
Pince à salade
Pinza ensalada

PA+
plus

art. l. cm.
12930-51 25
12930-52 32



Molla per pane e pasticceria
Bread and pastry tong
Brot-/Gebäckzange
Pince à pain et pâtisserie
Pinza para pan y pasteleria

PA+
plus

art. l. cm.
12930-62 18
12930-63 23



Molla tutto servire
Serving tong
Servierzange
Pince à servir
Pinza servir

PA+
plus

art. l. cm.
12930-68 20
12930-69 25



Molla spaghetti
Spaghetti tong
Spaghettizange
Pince à spaghetti
Pinza espagueti

PA+
plus

art. l. cm.
12930-74 24



Molla per toast e dolci
Toast and pastry tong
Toast-/Gebäckzange
Pince à toast et tarte
Pinza para tostadas y dulces

PA+
plus

art. l. cm.
12930-77 21
12930-78 25



Forbice per polpette
Meat ball plier
Fleischkugelzange
Pince à boulettes
Pinza albóndigas

PA+
plus

art. l. cm.
12931-51 17



Forbice per quenelle
Quenelle plier
Quenellezange
Pince à quenelles
Pinza quenelles

PA+
plus

art. l. cm.
12931-53 19



Mestolo forato
Perforated ladle
Schöpflöffel, gelocht
Louche perforée
Cacillo perforado

PA+
plus

art. cm. l.
12967-06 6,5 30,0
12967-10 10,0 37,5

UTENSILI KITCHEN UTENSILS



Mestolo
Ladle
Schöpflöffel
Louche
Cacillo

PA+
plus

art.	ø cm.	l.
12970-06*	6,5	30,0
12970-08	8,0	33,5
12970-10	10,0	37,5
12970-12	12,0	40,0

*Con becco. - With spout.



Mestolo pizza, fondo piatto
Pizza ladle, flat bottom
Schöpflöffel
Louche
Cacillo

PA+
plus

art.	ø cm.	l.
12968-10	10	27

Il fondo piatto distribuisce uniformemente la salsa di pomodoro senza lasciare scie.
The flat bottom evenly distributes tomato sauce without leaving streaks



Mestolo, manico corto
Ladle, short handle
Schöpflöffel mit kurzen Stiel
Louche, manche court
Cacillo, mango corto

PA+
plus

art.	ø cm.	l.
12969-10	10,0	27



Mestolo, manico corto
Ladle, short handle
Schöpflöffel mit kurzen Stiel
Louche, manche court
Cacillo, mango corto

PA+
plus

art.	ø cm.	l.
12969-06	6,5	24



Cucchiaione
Spoon
Löffel
Cuillère
Cuchara

PA+
plus

art.	l. cm.
12982-38	37,5



Cucchiaione
Spoon
Löffel
Cuillère
Cuchara

PA+
plus

art.	l. cm.
12986-38	37,5



Cucchiaione, manico corto
Spoon, short handle
Löffel mit kurzen Stiel
Cuillère, manche court
Cuchara, mango corto

PA+
plus

art.	l. cm.
12986-01	23



Schiumarola
Skimmer
Schaumlöffel
Ecumoire
Espumadera

PA+
plus

art.	ø cm.	l.
12971-10	10	31
12971-12	12	37



Paletta liscia
Spatula
Backschaufel
Spatule
Espátula lisa

PA+
plus

art.	cm.	l.
12972-10	10	36,5
12972-12	12	38,0



Paletta forata
Perforated spatula
Backschaufel, perforiert
Spatule perforée
Espátula perforada

PA+
plus

art.	cm.	l.
12973-10	10	36,5
12973-12	12	38,0



Colatutto, inox
Strainer, stainless steel
Sieb, Edelstahl Rostfrei
Passoire, inox
Colador multiuso, inox

PA+
plus

art.	dim. cm.	l.
12932-22	22x18,5	44
12932-26	26x21	47



Colino a rete, inox
Soup strainer, s/s
Suppensieb, Edelstahl Rostfrei
Passe-bouillon, inox
Colador a red, inox

PA+
plus

art.	ø cm.	l.
12941-07	7	12
12941-10	10	12
12941-12	12	17
12941-14	14	17
12941-16	16	17
12941-18	18	17
12941-20	20	17
12941-23	23	27
12941-26	26	27



Colatutto tronco conico
Conical colander
Gemüseeseher
Passoire à légumes
Colador cónico

PA+
plus

art.	ø cm.	h.	lt.
12950-32	32	16	8
12950-40	40	20	12



Frusta, 8 fili silicone
Wire whip, 8 Silicone wires
Rührbesen, 8 Drähte aus Silikon
Fouet, 8 fils en silicone
Batidor, 8 varillas de siliconea

PA+
plus

art.	l. cm.
12926-35	35

La forma tonda progettata per incorporare più aria possibile nelle miscele, è perfetta per sbattere più rapidamente ed efficientemente i bianchi d'uovo per soufflé eterei e meringhe, per panna montata e per creare ripieni e guarnizioni soffici. - Balloon shape accomplishes tasks from beating eggs to blending sauces quickly and efficiently. Its shape is designed to incorporate as much air as possible into your mixture. Sturdy and versatile, perfect for beating egg whites for ethereal soufflés and meringues. Or use it for whipping cream to create light, fluffy fillings and toppings.



PA+
plus

Frusta, 8 fili, inox
Wire whip, 8 wires, stainless steel
Rührbesen, 8 Drähte, Edelstahl Rostfrei
Fouet, 8 fils, inox
Batidor, 8 varillas, inox

art.	l. cm.
12928-25	25
12928-30	30
12928-35	35
12928-40	40
12928-45	45
12928-50	50
12928-55	55
12928-60	60

Perfetta tenuta stagna, lavabile in lavastoviglie. - Water-tight, dishwasher safe.



PA+
plus

Frusta media, 11 fili, inox
Egg whisk, 11 wires, stainless steel
Schneebeesen, 11 Drähte, Edelstahl
Fouet, 11 fils, inox
Batidor, 11 varillas, inox

art.	l. cm.
12929-25	25
12929-30	30
12929-35	35
12929-40	40
12929-45	45

Perfetta tenuta stagna, lavabile in lavastoviglie. - Water-tight, dishwasher safe.

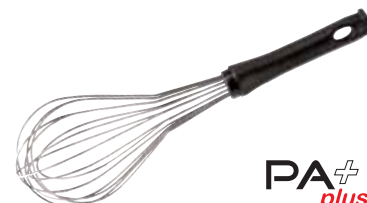

PA+
plus

Frusta balloon, inox
Balloon whisk, stainless steel
Schneebeesen, Edelstahl Rostfrei
Fouet à blancs, inox
Batidor tipo globo, inox

art.	l. cm.
12927-35	35
12927-45	45

Perfetta tenuta stagna, lavabile in lavastoviglie. - Water-tight, dishwasher safe.

POLICARBONATO - POLYCARBONATE



Molla spaghetti
Spaghetti tong
Spaghettizange
Pince à spaghetti
Pinza espagueti

art.	l. cm.
44929-08	23,5



Forbice per pane e dolci
Bread and pastry plier
Brot u. Gebäckzange
Pince à pain et pâtisserie
Pinza pan y pasteles

art.	l. cm.
44929-11	22

SPATOLE - TURNERS



Spatole in acciaio inox con manico in polipropilene.

Stainless steel turners with polypropylene handle.



Paletta forata
Perforated spatula
Kuchenpalette, geschlitzt
Palette perforée
Paleta perforada

art. dim. cm.
18510-07 13,5x7



Spatola forata
Perforated spatula
Kuchenpalette, geschlitzt
Palette perforée
Paleta perforada

art. dim. cm.
18509-01 16x7,5
18509-02 15,6x5



Paletta forata, flessibile
Perforated spatula, flexible
Palette, geschlitzt, flexibel
Palette perforée, flexible
Paleta perforada, flexible

art. dim. cm.
18509-03 15,6x8,7



Spatola per pasticcio e pizza
Pizza turner
Pizzawender
Palette à pizza
Espátula pizza

art. dim. cm.
18511-15 15,5x8,7



Spatola hamburger
Hamburger turner
Hamburgerspachtel
Palette à hamburger
Espátula hamburger

art. dim. cm.
18512-15 19x13,8



Spatola lasagne
Lasagne spatula
Lasagneheber
Palette à lasagne
Espátula lasagna

art. dim. cm.
18515-16 16,8x7,2



Spatola triangolare
Cleaning spatula
Bratenspachtel
Spatule
Espátula triangular

art. dim. cm.
18520-04 12x4
18520-06 12x6
18520-08 12x8
18520-10 12x10
18520-12 12x12



Spatola hamburger
Hamburger turner
Bratenwender
Grand palette
Espátula hamburger

art. dim. cm.
18516-24 24x7,2



Spatola hamburger, forata
Perforated hamburger turner
Bratenspachtel, gelocht,
Grand palette perforée
Espátula hamburger, perforada

art. dim. cm.
18517-24 24x7,2



Spatola cuoco con scalino
Angular spatula
Confiseriepalette
Palette coudée
Espátula chef angular

art. dim. cm.
18518-22 22x3,4
18518-26 25x3,7
18518-30 30x4,3



Spatola cuoco
Spatula
Palette
Palette
Espátula chef

art. dim. cm.
18519-15 15,5x3
18519-22 22x3,4
18519-26 26x3,7
18519-30 31x4,3
18519-35 36x5



Paletta dolci
Pastry spatula
Gebäckpalette
Palette à gâteau
Pala pasteles

art. dim. cm.
18513-14 14,5x6,5



Spatola dolce
Pastry spatula
Kuchenpalette
Palette à pâtissier
Espátula dulces

art. dim. cm.
18514-17 16,3x5,8



Coltello torta
Pie knife
Tortenmesser
Couteau à gâteau
Cuchillo pasteles

art. dim. cm.
18514-18 17,3x5,8



Coltello per farinata
Farinata knife
Farinata Messer
Couteau à farinata
Cuchillo farinata

art. l. cm.
42830-08 8

MESTOLI - *LADLES*



Il mestolo PADERNO.
Accoppiamento manico-coppa (mestolo unipezzo). Manico con spessore maggiorato con bordi arrotondati. Indicazione sul manico del diametro e della capacità.

The PADERNO ladle.
Handle-cup connection (one piece ladle). Thicker handle with rounded border. Diameter and capacity stamped on the handle.



NSF

Mestolo unipezzo, inox
One piece ladle, stainless steel
Schöpflöffel, fugenlos, Edelstahl Rostfrei
Louche monobloc, inox
Cacillo monobloc, acero inox

art.	ø cm.	l.	lt.
11970-06	6,5	30	0,07
11970-08	8,0	32	0,12
11970-09	9,0	33	0,20
11970-10	10,0	37	0,25
11970-11	11,0	38	0,33
11970-12	12,0	40	0,50
11970-14	14,0	44	0,75
11970-16	16,0	47	1,00



NSF

Mestolo con manico a tubo, inox
Ladle, tube handle, stainless steel
Schöpflöffel mit Rohrstiel, Edelstahl
Louche avec manche tubulaire, inox
Cacillo con mango tubolar, acero inox

art.	ø cm.	l.	lt.
11968-18	18	75	1,5
11968-20	20	75	2,0
11968-24	24	75	4,0



NSF

Mestolo forato unipezzo, inox
One piece perforated ladle, s/s
Gelochter Schöpflöffel, fugenlos, E. R.
Louche monobloc perforée, inox
Cacillo monobloc perforado, inox

art.	ø cm.	l.	lt.
11967-06	6,5	30	0,07
11967-08	8,0	32	0,12
11967-09	9,0	33	0,20
11967-10	10,0	37	0,25
11967-12	12,0	40	0,50
11967-14	14,0	44	0,75
11967-16	16,0	47	1,00



NSF

Mestolo forato con manico a tubo, inox
Perforated ladle, tube handle, s/s
Schöpflöffel, gelocht mit Rohrstiel, E. R.
Louche perforée, manche tubulaire, inox
Cacillo perforado mango tubolar, inox

art.	ø cm.	l.	lt.
11967-18	18	75	1,5
11967-20	20	75	2,0
11967-24	24	75	4,0



NSF

Mestolo becco a versare unipezzo, inox
One piece side basting spoon, s/s
Saucenkelle quer, fugenlos, Edelstahl
Cuillère à arroser monobloc, inox
Cacillo monobloc para versar, inox

art.	ø cm.	l.	lt.
11969-06	6,5	30	0,07



NSF

Mestolo per mancini, inox
Side basting spoon, left handed, s/s
Saucenkelle für Linkshänder, Edelstahl
Cuillère à arroser, gaucher, inox
Cacillo para zurdos, inox

art.	ø cm.	l.	lt.
11969-37	6,5	30	0,07



NSF

Cucchiaione unipezzo, inox
One piece basting spoon, stainless steel
Giesslöffel, fugenlos, Edelstahl Rostfrei
Cuillère monobloc, inox
Cucharón monobloc, inox

art.	l. cm.
11982-38	38



NSF

Cucchiaione forato unipezzo, inox
One piece perforated spoon, s/s
Giesslöffel perforiert, fugenlos, Edelstahl
Cuillère perforée monobloc, inox
Cucharón perforado, monobloc, inox

art.	l. cm.
11984-38	38



NSF

Cucchiaione obliquo unipezzo, inox
One piece spoon, crosswise, s/s
Giesslöffel quer, fugenlos, Edelstahl
Cuillère oblique monobloc, inox
Cucharón obliquo monobloc, inox

art.	l. cm.
11983-38	38

UTENSILI KITCHEN UTENSILS



NSF

Cucchiaione per mancini, inox
Spoon, left handed, stainless steel
Giesslöffel für Linkshänder, Edelstahl
Cuillère gaucher, inox
Cucharón para zurdos, inox

art.	l. cm.
11983-37	38



NSF

Forchettone 3 denti unipezzo, inox
One piece meat fork, 3 prongs, s/s
Fleischgabel 3 Zacken, fugenlos, E. R.
Fourchette 3 dents, monobloc, inox
Tenedor 3 dientes, monobloc, inox

art.	l. cm.
11974-50	50
11974-70	70



NSF

Forchettone 2 denti unipezzo, inox
One piece meat fork, 2 prongs, s/s
Fleischgabel 2 Zacken, fugenlos, E. R.
Fourchette 2 dents, monobloc, inox
Tenedor 2 dientes, monobloc, inox

art.	l. cm.
11975-50	50
11975-99	100



NSF

Paletta liscia unipezzo, inox
One piece spatula, stainless steel
Backschaufel, fugenlos, Edelstahl
Spatule monobloc, inox
Espátula lisa monobloc, inox

art.	cm.	l.
11972-10	10	36
11972-12	12	39



NSF

Paletta forata unipezzo, inox
One piece perforated spatula, s/s
Backschaufel perforiert, fugenlos, E. R.
Spatule perforée monobloc, inox
Espátula perforada monobloc, inox

art.	cm.	l.
11973-10	10	36
11973-12	12	39



NSF

Pala a ridurre, inox
Perforated slice, stainless steel
Reduzierspatel, Edelstahl Rostfrei
Spatule à réduire, inox
Espátula para reducir, inox

art.	cm.	l.
11976-50	12x15	50
11976-99	12x15	100



NSF

Paletta pesce unipezzo, forata, inox
One piece fish spatula, stainless steel
Fischwender, fugenlos, Edelstahl Rostfrei
Pelle à poisson monobloc, inox
Pala pescado, monobloc, inox

art.	dim. cm.	l. cm.
11985-34	15x20	42



NSF

Schiumarola unipezzo, inox
One piece skimmer, stainless steel
Schaumlöffel, fugenlos, Edelstahl
Ecumoire monobloc, inox
Espumadera monobloc, inox

art.	ø cm.	l.
11971-08	8	29,0
11971-10	10	32,0
11971-12	12	35,0
11971-14	14	38,0
11971-16	16	41,0
11971-18	18	42,5
11971-20	20	44,5
11971-25*	25	75,0

*Manico a tubo. - Tube handle.



NSF

Mestolo unipezzo, inox
One piece ladle, stainless steel
Schöpföffel, fugenlos, Edelstahl Rostfrei
Louche monobloc, inox
Cacillo monobloc, acero inox

art.	ø cm.	l.	lt.
11970-01	8	23	0,12

Manico corto. - Short handle.



NSF

Mestolo con becco a versare, inox
Side basting spoon, stainless steel
Saucenkelle mit seitlichem Ausguß, E. R.
Cuillère à arroser, inox
Cacillo para versar, inox

art.	ø cm.	l.	lt.
11969-02	6,5	23	0,07



NSF

Cucchiaione unipezzo, inox
One piece spoon, stainless steel
Giesslöffel, fugenlos, Edelstahl Rostfrei
Cuillère monobloc, inox
Cuchara monobloc, inox

art.	l. cm.
11982-01	23,5



NSF

Forchettone unipezzo, inox
One piece meat fork, stainless steel
Fleischgabel, fugenlos, Edelstahl
Fourchette monobloc, inox
Tenedor monobloc, inox

art.	l. cm.
11975-01	26

Manico corto. - Short handle.



Paletta forata unipezzo, inox
One piece perforated spatula, s/s
Backschaufel perforiert, fugenlos, E. R.
Spatule perforée monobloc, inox
Espátula perforada monobloc, inox

art.	dim. cm.	l.
11973-01	8x9,5	24

Manico corto. - Short handle.



Schiumarola unipezzo, inox
One piece skimmer, stainless steel
Schaumlöffel, fugenlos, Edelstahl
Ecumoire monobloc, inox
Espumadera monobloc, inox

art.	ø cm.	l.
11971-01	9	26



Asta, inox
Wall rack, stainless steel
Aufhängungstange, Edelstahl Rostfrei
Tringle de cuisine, inox
Asta para utensilios, inox

art.	l. cm.
41670-AA	40
41670-AB	60



Mestolo, inox
Ladle, stainless steel
Schöpflöffel, Edelstahl Rostfrei
Louche, inox
Cacillo, inox

art.	ø cm.	l.	lt.
41670-06	6	30	0,03
41670-09	9	32	0,13



Schiumarola, inox
Skimmer, stainless steel
Schaumlöffel, Edelstahl Rostfrei
Ecumoire, inox
Espumadera, inox

art.	ø cm.	l.
41671-11	11	32



Paletta forata, inox
Slotted turner, stainless steel
Küchenwender, geschlitzt, Edelstahl
Pelle ajourée, inox
Espátula perforada, inox

art.	l. cm.
41672-00	32



Cucchiaio per spaghetti, inox
Spaghetti spoon, stainless steel
Spaghettilöffel, Edelstahl Rostfrei
Cuillère à spaghetti, inox
Tenedor espaguetitis, inox

art.	l. cm.
41673-00	32



Forchettone, inox
Meat fork, stainless steel
Fleischgabel, Edelstahl Rostfrei
Fourchette, inox
Tenedor, inox

art.	l. cm.
41674-00	32



Cucchiaione, inox
Basting spoon, stainless steel
Giesslöffel, Edelstahl Rostfrei
Cuillère, inox
Cuchara, inox

art.	l. cm.
41675-00	32



Cucchiaione forato, inox
Perforated spoon, stainless steel
Schöpfkelle, gelocht, Edelstahl Rostfrei
Cuillère percée, inox
Cuchara perforada, inox

art.	l. cm.
41676-00	32



Cucchiaione salse, inox
Sauce ladle, stainless steel
Saucenkelle, Edelstahl Rostfrei
Cuillère à sauce, inox
Cuchara salsas, inox

art.	l. cm.
41677-00	32

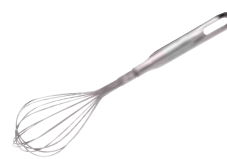

Frusta, inox
Whisk, stainless steel
Schneebeesen, Edelstahl Rostfrei
Fouet, inox
Batidor, inox

art.	l. cm.
41678-00	30



Schiumarola a rete stirata, inox
Mesh skimmer, stainless steel
Schaumlöffel, Edelstahl Rostfrei
Ecumoire, inox
Espumadera, inox

art.	ø cm.	l.
11990-16	16	40



Schiumarola a rete passabrodo, inox
Mesh skimmer, stainless steel
Schaumlöffel, Edelstahl Rostfrei
Ecumoire, inox
Espumadera, inox

art.	ø cm.	l.
11991-16	16	40



Colafritto, inox
Bird nest fryer, stainless steel
Nestbacklöffel, Edelstahl Rostfrei
Nid à friture, inox
Molde nido, inox

art.	ø cm.	l.
42623-10	10	26



Schiumarola a filo inox
Wire skimmer, stainless steel
Drahtlöffel, Edelstahl Rostfrei
Araignée, inox
Araña, inox

art.	ø cm.	l.
12640-14	14	40
12640-16	16	40
12640-18	18	40
12640-20	20	50
12640-24	24	50
12640-28	28	50



Schiumarola a filo inox
Wire skimmer, stainless steel
Drahtlöffel, Edelstahl Rostfrei
Araignée, inox
Araña, inox

art.	ø cm.	l.
12641-14	14	40
12641-16	16	40
12641-18	18	40
12641-20	20	50
12641-24	24	50
12641-28	28	50



Schiumarola a filo inox
Wire skimmer, stainless steel
Drahtlöffel, Edelstahl Rostfrei
Araignée, inox
Araña, inox

art.	ø cm.	l.
12642-28	28	85



Pala per patate fritte, inox
French fry scoop, stainless steel
Frittenschaufel, Edelstahl Rostfrei
Pelle à frites, inox
Pala chips, inox

art.	dim. cm.
41929-00	20x23



Spatola legno
Wood spatula
Holzschäber
Spatule en bois
Espátula de madera

art.	l. cm.
42907-30	30
42907-35	35
42907-40	40



Spatola legno
Wood spatula
Holzschäber
Spatule en bois
Espátula de madera

art.	l. cm.
42907-01	25
42907-02	30
42907-03	35
42907-04	40
42907-06	50
42907-07	60
42907-08	80
42907-09	100
42907-10	120



Cucchiaione legno
Wood mixing spoon
Holzlöffel
Cuillère en bois
Cuchara de madera

art.	l. cm.
42901-20	20
42901-25	25
42901-30	30
42901-35	35
42901-40	40



Spatole crêpes, legno
Crepe spreader, beachwood
Crêpe-Paletten, Holz
Rateau à crêpes/raclettes, hêtre
Espátula crêpes, madera

art.	dim. cm.	u.pack
42900-15	18x18	5
42900-24	18x24	5



Pinza togli lische, inox
Fish-bone remover, stainless steel
Grätenentkerner, Edelstahl Rostfrei
Pince à arêtes, inox
Pinza para espinas

art.	l. cm.	
42592-01	12	lische fini/thin bones
42592-02	12	lische grosse/thick bones



Pompetta per sugo, inox
Baster tube, stainless steel
Saft-Spritze, Edelstahl Rostfrei
Pompe à jus, inox
Bomba para jugo, inox

art.	l. cm.
42863-00	20



Pinza per grill, inox
Sausage tongs, stainless steel
Grill-und Wurstzange, Edelstahl Rostfrei
Pince à saucisses, inox
Pinza para barbacoa, inox

art.	l. cm.
41697-00	38



P

Pinza, inox
Cooking tong, stainless steel
Kochzange, Edelstahl Rostfrei
Pince, inox
Pinza, inox

art.	l. cm.
42904-01	16



P

Pinza, inox
Cooking tong, stainless steel
Kochzange, Edelstahl Rostfrei
Pince, inox
Pinza, inox

art.	l. cm.
42904-02	16



P

Pinza, inox
Cooking tong, stainless steel
Kochzange, Edelstahl Rostfrei
Pince, inox
Pinza, inox

art.	l. cm.
42904-03	15

Ideali per impiattare cibi delicati, la preparazione e decorazione di piatti. - Ideal for lifting and turning soft food and to decorate dishes.



P

Pinza, inox
Cooking tong, stainless steel
Kochzange, Edelstahl Rostfrei
Pince, inox
Pinza, inox

art.	l. cm.
42902-31	30



P

Pinza, inox
Cooking tong, stainless steel
Kochzange, Edelstahl Rostfrei
Pince, inox
Pinza, inox

art.	l. cm.
42902-30	30



Molla per grill, inox
Grill tweezer, stainless steel
Grillzange, Edelstahl Rostfrei
Pince à grill, inox
Pinza para barbacoa, inox

art.	l. cm.
41698-22	22,5
41698-30	30,0
41698-40	40,0



Pinza a servire, inox
Serving tong, stainless steel
Servierzange, Edelstahl
Pince à servir, inox
Pinza para servir, inox

art.	l. cm.
42854C25	25
42854C30	30



Pinza a servire, inox
Serving tong, stainless steel
Servierzange, Edelstahl
Pince à servir, inox
Pinza para servir, inox

art.	l. cm.
42854B25	25
42854B30	30



Pinza a servire, inox
Serving tong, stainless steel
Servierzange, Edelstahl
Pince à servir, inox
Pinza para servir, inox

art.	l. cm.
42854Y25	25
42854Y30	30

UTENSILI KITCHEN UTENSILS



Pinza a servire, inox
 Serving tong, stainless steel
 Servierzange, Edelstahl
 Pince à servir, inox
 Pinza para servir, inox

art.	l. cm.
42854K25	25
42854K30	30



Pinza a servire, inox
 Serving tong, stainless steel
 Servierzange, Edelstahl
 Pince à servir, inox
 Pinza para servir, inox

art.	l. cm.
42854R25	25
42854R30	30



Pinza a servire, inox
 Serving tong, stainless steel
 Servierzange, Edelstahl
 Pince à servir, inox
 Pinza para servir, inox

art.	l. cm.
42854G25	25
42854G30	30



Spazzola grill
 Barbecue brush
 Grill-Bürste
 Brosse à grille
 Cepillo para barbacoa

art.	dim. cm.	l.
41773-00	5,5x11	27

Setole in ottone. - Brass bristles.



Pinza, silicone
 Cooking tong, silicone
 Kochzange aus Silikon
 Pince en silicone
 Pinza de silicona

art.	l. cm.
42903-29	29



Frusta gigante, inox
 Whisk for basin, stainless steel
 Kesselbesen, Edelstahl Rostfrei
 Fouet à bassine, inox
 Batidor gigante, inox

art.	l. cm.
41980-99	125

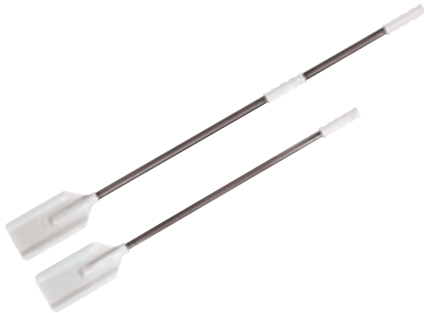

Spatola in resina alimentare
 Food spatula
 Rührspaten für Speisenzubereitung
 Spatule pour aliments
 Espátula

art.	dim. cm.	l.
44061-08	15,7x10,8	80
44061-09	23,5x10,8	90
44061-12	23,5x10,8	117
44061-14	23,5x10,8	137



Rastrelliera, inox
 Speed rack, stainless steel
 Flaschenregal, Edelstahl Rostfrei
 Rack à bouteilles, inox
 Rack de botellas, inox

art.	dim. cm.	h.	bot.
44060-50	56x10,5	15,5	6
44060-80	81x10,5	15,5	8



Spillone portascontrini, inox
 Hat pin for tickets, stainless steel
 Kassenscheine-Aufstecknadel, Edelstahl
 Pique-addition, inox
 Pinchanotas, inox

art.	ø cm.	h.
12504-20	9	20



Spillone portascontrini, legno
 Hat pin for tickets, wood
 Kassenscheine-Aufstecknadel, Holz
 Pique-addition, bois
 Pinchanotas, madera

art.	dim. cm.	h.
42504-09	9x5,5	10,5
42504-20	20x5,5	10,5



Asta portascontrini, inox
 Tickets-holder, stainless steel
 Bons-/Zettelhalter, Edelstahl Rostfrei
 Porte-fiches à billes, inox
 Barra de notas, inox

art.	l. cm.
42509-25	25
42509-50	50



Asta porta scontrini, inox
 Tab-grabber, stainless steel
 Bons-/Zettelhalter, Edelstahl Rostfrei
 Porte-fiches, inox
 Barra de notas, inox

art.	l. cm.
42509-60	60
42509-99	100



Porta rotolo, inox
Roll holder, stainless steel
Rollenhalter, Edelstahl Rostfrei
Derouleur papier, inox
Portarollos, inox

art.	l. cm.
42512-35	30



Supporto murale, porta pellicola, inox
Film box, stainless steel
Folien-Abreißgerät, 18-10 Rostfrei
Dérouleur de film, inox
Soporte de muro para film, inox

art.	l. cm.
42513-30	30
42513-45	45

Rotolo ø max. cm 13. - Roll ø max cm 13.



FORNI MICROONDE
MICROWAVE OVENS
PAGINA - PAGE: 162



Anello distanziatore, PP
Additional plate stand, PP
Gestell für Zusatzteller, PP
Support assiette supplémentaire, PP
Soporte distanciador, PP

art.	Ø cm.	h.
47605-23	19-21	6



Copripiatto per microonde, PP
Microwave plate cover, PP
Tellerlocke für Mikrowelle, PP
Cloche pour four à micro-ondes, PP
Cubreplatos para microonda, PP

art.	Ø cm.	h.
47603-25	25	6,5
47603-27	27	6,5
44998-31	31	6,5

Impilabile, lavabile in lavastoviglie.
Stackable, dishwasher safe.



Copripiatto, policarbonato
Plate cover, polycarbonate
Tellerlocke, Polykarbonat
Cloche, polycarbonate
Cubreplatos, PC

art.	Ø int. cm.	h.
44997-22	21	6,8
44997-24	23	6,8
44997-26	26	6,8
44997-28	28	6,8



Copripiatto, inox
Plate cover, stainless steel
Tellerlocke, Edelstahl Rostfrei
Cloche, inox
Cubreplatos, inox

art.	Ø cm.	h.
41683-26	26,5	4,3



Imbuto, inox
Funnel, stainless steel
Trichter, Edelstahl Rostfrei
Entonnoir, inox
Embudo, inox

art.	Ø cm.
42562-12	12
42562-14	14
42562-16	16
42562-18	18
42562-20	20
42562-25	25
42562-30	30



Imbuto, polipropilene
Funnel, PP
Trichter, PP
Entonnoir, PP
Embudo, PP

art.	Ø cm.
47604-08	8
47604-10	10
47604-12	12
47604-15	15
47604-18	18
47604-20	20
47604-24	24
47604-30	30



Caraffa graduata, PP
Measuring jug, PP
Messbecher, PP
Pichet gradué, PP
Jarra de medidas, PP

art.	ø cm.	h.	lt.
47608-02	19	12	2,2



Caraffa graduata, PP
Measuring jug, PP
Messbecher, PP
Pichet gradué, PP
Jarra de medidas, PP

art.	ø cm.	h.	lt.
47606-02	8,5	10,0	0,25
47606-05	10,5	10,5	0,50
47606-10	12,5	14,5	1,00
47606-20	13,5	17,0	2,00
47606-30	15,5	21,0	3,00
47606-50	19,0	24,0	5,00



Caraffa graduata, impilabile, PP
Measuring jug, stackable, PP
Messbecher, stapelbar, PP
Pichet gradué, empilable, PP
Jarra de medidas apilable, PP

art.	ø cm.	h.	lt.
47607-10	12,5	14,5	1
47607-20	13,5	17,0	2

Scala in litri e ml. Resistente fino a 95°C.
Litre and ml. scale. Temperature resistant up to 95°C.



Misurino graduato, impilabile, inox
Graduated measure jug, stackable, s/s
Messbecher, graduiert, stapelbar, E. R.
Mesure graduée, empilable, inox
Jarra de medidas apilable, inox

art.	ø cm.	h.	lt.
42581-01	7,5	5	0,1
42581-03	10,0	7	0,3
42581-05	11,5	11	0,5
42581-10	15,0	13	1,0
42581-15	15,5	15	1,5
42581-20	17,0	19	2,0



Set 4 misurini, inox
Measuring spoons 4 pcs, stainless steel
Messlöffel Set 4-tlg., Edelstahl Rostfrei
Cuillères à mesurer 4 pcs, inox
Juego 4 cucharas medidoras, inox

art.	ml.
42615-04	1-2,5-5-15



Set 4 misurini, inox
Measuring cups, 4 pcs, stainless steel
Messlöffel Set 4-tlg., Edelstahl Rostfrei
Cuillères à mesurer 4 pcs, inox
Juego 4 cucharas medidoras, inox

art.	ml.
42616-04	60-80-125-250



Sessola tonda, inox
Flour scoop, stainless steel
Mehlschaufel, Edelstahl Rostfrei
Pelle à farine, inox
Librador, inox

art.	lt.
42609-10	0,1
42609-15	0,4
42609-20	1,0
42609-23	1,7
42609-25	2,8



Sessola, PP
Flour scoop, PP
Mehlschaufel, PP
Pelle à farine, PP
Librador, PP

art.	dim. cm.	lt.
17610-01	20x7	0,10
17610-02	27,5x9,5	0,25
17610-05	32,5x12	0,50
17610-10	39x15	1,00



Sessola
Flour scoop
Mehlschaufel
Pelle à farine
Librador

art.	dim. cm.	lt.
12940-02	27,5x9,5	0,25
12940-05	32,5x12	0,50
12940-10	39x15	1,00
12940-20	48x18	2,00
12940-25	50x19,5	2,50

PA
plus



Setaccio rete intercambiabile, inox
Sieve with spare gauzes, stainless steel
Sieb mit auswechselbarem Siebeinsatz
Tamis avec toiles de rechange, inox
Cernidor con red intercambiabile, inox

art.	ø cm.	rete/mesh
42590-01	30	1,4 mm
42590-02	30	1,1 mm
42590-03	30	0,9 mm

Rete intercambiabile, inox
Spare gauzes, stainless steel
Auswechselbarem Siebeinsatz
Toiles de rechange, inox
Red intercambiabile, inox

art.	ø cm.	rete/mesh
42590R01	30	1,4 mm
42590R02	30	1,1 mm
42590R03	30	0,9 mm



Setaccio pane, inox
Bread sieve, stainless steel
Brotsieb, Edelstahl Rostfrei
Tamis à pain, inox
Cernidor para pan, inox

art.	ø cm.	h.
12604-22	22	8
12604-30	30	8
12604-34	34	8
12604-40	40	8

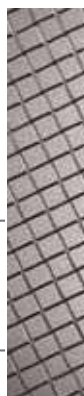

8

Numero dei fori per 2,5 cm².
Eye per inch.



Setaccio farina, inox
Flour sieve, stainless steel
Mehlsieb, Edelstahl Rostfrei
Tamis à farine, inox
Cernidor para harina, inox

art.	ø cm.	h.
12605-22	22	8
12605-30	30	8
12605-34	34	8
12605-40	40	8

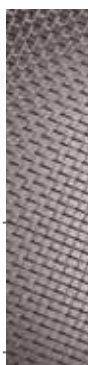

20

Numero dei fori per 2,5 cm².
Eye per inch.



Setaccio infarina pesce, inox
Sieve, stainless steel
Sieb, Edelstahl Rostfrei
Tamis, inox
Cernidor, inox

art.	ø cm.	h.
12606-30	30	8
12606-34	34	8

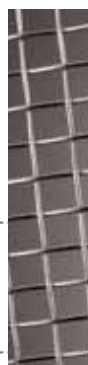

4

Numero dei fori per 2,5 cm².
Eye per inch.



Setaccio rete pasticcere, inox
Sieve, stainless steel
Sieb, Edelstahl Rostfrei
Tamis, inox
Cernidor, inox

art.	ø cm.	h.
12607-22	22	8
12607-30	30	8
12607-34	34	8

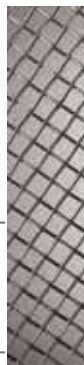

10

Numero dei fori per 2,5 cm².
Eye per inch.



Bacinella conica con maniglie, inox
Kitchenbowl, with handles, s/s
Schüssel mit Griffen, Edelstahl Rostfrei
Bassine conique avec anses, inox
Caldero cónico con asas, inox

art.	ø cm.	h.	lt.
11955-32	32	16,0	8,8
11955-36	36	18,5	12,8
11955-40	40	20,0	17,0
11955-45	45	22,5	24,5
11955-50	50	24,0	32,5



Colapasta tronco conico, inox
Conical colander, stainless steel
Gemüsesieher, Edelstahl Rostfrei
Passoire à légumes, inox
Colador cónico, inox

art.	ø cm.	h.	lt.
11930-24	24	12,0	3,5
11930-28	28	14,0	5,5
11930-32	32	16,0	8,8
11930-36	36	18,5	12,8
11930-40	40	20,0	17,0
11930-45	45	22,5	24,5
11930-50	50	24,0	32,5



Colapasta tronco conico, inox
Conical colander, stainless steel
Gemüsesieher, Edelstahl Rostfrei
Passoire à légumes, inox
Colador cónico, inox

art.	ø cm.	h.	lt.
11927-24	24	12,0	3,5
11927-28	28	14,0	5,5
11927-32	32	16,0	8,8
11927-36	36	18,5	12,8
11927-40	40	20,0	17,0
11927-45	45	22,5	24,5
11927-50	50	24,0	32,5

UTENSILI KITCHEN UTENSILS



Bacinella semisferica, inox
Hemispherical mixing bowl, s/s
Schüssel, Edelstahl Rostfrei
Bassine demi-ronde, inox
Caldero semiesférico, inox

art.	ø cm.	lt.
11957-20	20	2,0
11957-25	25	3,7
11957-30	30	7,2
11957-35	35	10,5
11957-40	40	15,6



Bacinella conica bassa, inox
Kitchenbowl low, stainless steel
Schüssel, flach, Edelstahl Rostfrei
Bassine, inox
Caldero cónico, inox

art.	ø cm.	h.	lt.
12582-13	13,2	6,0	0,5
12582-17	16,5	7,5	1,0
12582-22	22,0	7,5	2,0
12582-24	24,0	9,5	3,0
12582-32	30,5	11,5	6,0
12582-34	32,5	14,0	8,0
12582-38	38,0	13,5	11,0
12582-40	40,0	15,0	14,0



Bacinella conica alta, inox
Kitchenbowl high, stainless steel
Tiefe Schüssel, Edelstahl Rostfrei
Bassine haute, inox
Caldero cónico alto, inox

art.	ø cm.	h.	lt.
12580-11	11,7	7,0	0,5
12580-17	15,5	9,0	1,0
12580-21	19,0	11,5	2,0
12580-24	22,0	12,0	3,0
12580-29	27,0	13,5	5,0
12580-30	29,0	15,0	6,0
12580-31	30,5	17,0	8,0
12580-36	35,5	18,5	11,0
12580-40	40,0	20,0	17,0
12580-45	45,0	22,0	25,0
12580-50	50,0	24,0	33,0



Colatutto tronco conico
Conical colander
Gemüseseiher
Passoire à légumes
Colador cónico

PA+
plus

art.	ø cm.	h.	lt.
12950-32	32	16	8
12950-40	40	20	12



Colapasta tronco conico, alluminio
Conical colander, aluminium
Gemüseseiher, Aluminium
Passoire à légumes, alu
Colador cónico, aluminio

art.	ø cm.	h.	lt.
16927-32	32	16,0	8,8
16927-36	36	18,5	12,8
16927-40	40	20,0	17,0
16927-45	45	22,5	24,5
16927-50	50	24,0	32,5



Colapasta con cerchio, inox
Colander, stainless steel
Gemüseseiher, Edelstahl Rostfrei
Passoire à légumes, inox
Colador con base, inox

art.	ø cm.	h.	lt.
11928-32	32	18	9,5
11928-36	36	19	12,0
11928-40	40	21	14,5



Colapasta semisferico, inox
Strainer, stainless steel
Stielsieb, Edelstahl Rostfrei
Passoire hémisphérique, inox
Colador semiesférico, inox

art.	ø cm.	h.	lt.
11926-22	22	12	2,7
11926-26	26	14	4,0



Colapasta, inox
Strainer, stainless steel
Stielsieb, Edelstahl Rostfrei
Passoire, inox
Colador, inox

art.	ø cm.	h.	lt.
11924-18	18	11	2,8
11924-20	20	12	3,6
11924-22	22	13	5,0
11924-24	24	14	6,5
11924-28	28	15	9,3



Colapasta, alluminio
Strainer, aluminium
Stielsieb, Aluminium
Passoire, alu
Colador, aluminio

art.	ø cm.	h.	lt.
16924-20	20	11	3,2
16924-24	24	13	6,0
16924-28	28	15	9,3



Colapasta, PP
Strainer, PP
Stielsieb, PP
Passoire, PP
Colador, PP

art.	ø cm.
47610-22	22
47610-26	26
47610-30	30



Colapasta, PP
Strainer, PP
Stielsieb, PP
Passoire, PP
Colador, PP

art.	ø cm.
47610-18	18



Secchio graduato, PE LD
Graduated bucket
Eimer mit Skala
Seau gradué
Cubo con medidas

art.	ø cm.	h.	lt.
49889-09	27	26,2	9
49889-12	29	29,0	12
49889-15	31	30,8	15

Con becco. - With spout.



Secchiello graduato, inox
Graduated bucket, stainless steel
Eimer mit Skala, Edelstahl Rostfrei
Seau gradué, inox
Cubo con medidas, inox

art.	ø cm.	h.	lt.
41960-08	28,5	20,5	8
41960-10	30,0	25,0	10
41960-12	31,0	27,0	12
41960-15	32,5	31,0	15



Secchiello graduato con base, inox
Graduated bucket with bottom ring, s/s
Eimer mit Fuss u. Skala, Edelstahl
Seau gradué avec base, inox
Cubo con medidas y base, inox

art.	ø cm.	h.	lt.
41961-10	30,0	26,5	10
41961-12	31,0	28,5	12
41961-15	32,5	32,5	15



Coperchio per secchiello, inox
Lid for bucket, stainless steel
Deckel für Eimer, Edelstahl Rostfrei
Couvercle pour seau, inox
Tapa para cubo, inox

art.	ø cm.
41962-10	30,0
41962-12	31,0
41962-15	32,5



Bacinella tonda, PE
Mixing bowl, PE
Schüssel, PE
Bassine ronde, PE
Caldero semiesférico, PE

art.	ø cm.	h.	lt.
47600-16	16	7,0	0,9
47600-20	20	8,5	1,6
47600-24	24	10,0	2,8
47600-28	28	11,0	4,5
47600-32	32	12,5	6,5
47600-36	36	14,0	10,0
47600-40	40	15,5	13,5



Bacinella tonda, PP
Mixing bowl, polypropylene
Schüssel, Polypropylen
Bassine ronde, polypropylène
Caldero semiesférico, PP

art.	ø cm.	h.	lt.
47611-01	19,0	7,9	1,0
47611-03	24,0	11,5	2,5
47611-05	28,0	13,5	4,5
47611-06	32,5	14,7	6,0
47611-09	36,0	16,5	9,0
47611-13	40,0	18,5	13,0



Coperchio, PP
Lid, PP
Deckel, PP
Couvercle, PP
Tapa, PP

art.	ø cm.
47611-11	19,0
47611-14	24,0
47611-15	28,0
47611-16	32,5
47611-19	36,0
47611-23	40,0

UTENSILI KITCHEN UTENSILS



Bastardella semisferica, inox
Mixing bowl, stainless steel
Schnees Schlagkessel, Edelstahl Rostfrei
Bassine hémispherique, inox
Caldero con asas, inox

art.	ø cm.	h.	lt.
11952-22	22	12,0	2,7
11952-26	26	14,0	4,0
11952-32	32	18,0	9,5
11952-36	36	20,5	14,0
11952-40	40	21,5	18,0



Bastardella senza maniglie, inox
Mixing bowl without handles, s/s
Schnees Schlagkessel ohne Griffe, E. R.
Bassine hémispherique sans anses, inox
Caldero sin asas, inox

art.	ø cm.	h.	lt.
11951-22	22	12,0	2,7
11951-26	26	14,0	4,0
11951-32	32	18,0	9,5
11951-36	36	20,5	14,0
11951-40	40	21,5	18,0



Base per bastardella, inox
Foot for mixing bowl, stainless steel
Fuss für Schneeschlagkessel, Edelstahl
Base pour bassine hémispherique, inox
Base para caldero, inox

art.	ø cm.	per/for ø
11953-16	16	22-26
11953-22	22	32-36-40



Bacinella per planetaria, inox
Kettle for mixing machines, s/s
Schlagmaschinenkessel, Edelstahl
Bol pour mélangeurs, inox
Caldero para batidera, inox

art.	ø cm.	h.	lt.
11954-26	26	20,0	10
11954-30	30	25,0	16
11954-32	32	30,0	20
11954-36	36	28,5	25
11954-37	36	35,0	32
11954-40	40	35,5	40



Tazzone con manico e gancio, inox
Kitchenbowl with handle and hook, s/s
Schlagschüssel mit Rohrstiel u. Haken
Bol avec manche et crochet, inox
Cazo bombeado con gancho, inox

art.	ø cm.	h.	lt.
41916-10	15	8	1,0
41916-15	17	9	1,2
41916-20	19	10	2,0



Centrifuga manuale per verdura
Manual salad spinner
Salatschleuder
Essoreuse manuelle à salade
Centrifugadora de ensalada

art.	ø cm.	h.	lt.
49888-10	33	43	12
49888-20	43	52	25



Colino a rete, inox
Soup strainer, stainless steel
Suppensieb, Edelstahl Rostfrei
Passe-bouillon, inox
Colador a red, inox

art.	ø cm.	l.
12622-07	7	12
12622-10	10	12
12622-12	12	17
12622-14	14	17
12622-16	16	17
12622-18	18	17
12622-20	20	17
12622-23	23	27
12622-26	26	27



Colapasta doppia rete, inox
Strainer, double mesh, stainless steel
Passiersieb, doppelnetz, Edelstahl
Passoire, maille double, inox
Colador doble red inox

art.	ø cm.	l.
12633-16	16	17
12633-18	18	17
12633-20	20	17
12633-23	23	27
12633-26	26	27



Colatutto, inox
Strainer, stainless steel
Sieb, Edelstahl Rostfrei
Passoire, inox
Colador multiuso, inox

art.	dim. cm.	l.
12630-22	22x18	19



Colapasta rinforzato, inox
Strainer, reinforced, stainless steel
Grossküchensieb mit Verstärkung, E. R.
Passoire renforcé, inox
Colador reforzado, red inox

art.	ø cm.	l.
12635-23	23	27
12635-26	26	27
12635-30	30	44
12635-35	35	44



Passaverdura, inox
Vegetable sieve, stainless steel
Passiergerät, Edelstahl Rostfrei
Mini hache-tout, inox
Pasa verdura, inox

art.	ø cm.
12638-20	20



Colatutto gigante, inox
Strainer, stainless steel
Grossküchensieb, Edelstahl Rostfrei
Passoire étamé, inox
Colador multiuso gigante, inox

art.	ø cm.	l.
12636-32	32	60



Cornetto cinese, inox
Chinese colander, stainless steel
Spitzsieb, Edelstahl Rostfrei
Passoire chinois, inox
Colador chino, inox

art.	ø cm.
41925-14	14
41925-16	16
41925-18	18
41925-20	20
41925-22	22
41925-24	24
41925-26	26



Supporto per cornetto cinese, inox
Chinese colander stand, stainless steel
Träger für Spitzsieb, Edelstahl Rostfrei
Support chinois, inox
Soporte para colador chino, inox

art.	ø cm.	h.
41933-18	18	28



Cornetto cinese a rete, inox
Colander with wire gauze, stainless steel
Gazensieb, Edelstahl Rostfrei
Chinois à gaze, inox
Colador chino a red, inox

art.	ø cm.
11929-20	20
11929-24	24



Cornetto c/protezione, inox
Chinese colander with wire protection, s/s
Spitzsieb mit Verstärkung, Edelstahl
Chinois à gaze avec renfort, inox
Colador chino con protección, inox

art.	ø cm.
11932-20	20
11932-24	24



Colino conico a rete, inox
Chinese soup strainer, stainless steel
Suppen-Spitzsieb, Edelstahl Rostfrei
Passe-bouillon chinois, inox
Colador cónico a red, inox

art.	ø cm.
41931-08	8
41931-14	14
41931-16	16
41931-18	18



Panno passabrodo
Bouillon cloth
Bouillonstoffsieb
Etamine passe-bouillon
Paño para pasar caldo

art.	dim. cm.	u.pack
41932-05	87x70	5

Tela di cotone ritorto, orlata.
Twisted cotton cloth with seam.



Porzionatore, ABS
Rice scoop, ABS
Reis-Portionierer, ABS
Portionneur, ABS
Racionador, ABS

art.	gr.	h.
42653-04	120-130	4,5



PA+
plus

Anello per impiattare
Portion ring
Portionierspeisering
Cercle portionneur
Anillo porcionador

art.	ø cm.	h.
12943-03	3	3,5
12943-05	5	3,5
12943-07	7	3,5
12943-08	8	3,5
12943-10	10	3,5
12943-12	12	3,5



PA+
plus

Anello per impiattare
Portion ring
Portionierspeisering
Cercle portionneur
Anillo porcionador

art.	ø cm.	h.
12944-03	3	3,5
12944-05	5	3,5
12944-07	7	3,5
12944-08	8	3,5
12944-10	10	3,5
12944-12	12	3,5



N

Clip chiudi sacco, PP
Bag clip
Verschluss-Clip
Clip ferme sachet
Pinza cierra bolsas

art.	l. cm	pz/pcs
42908-14	14	3
42908-24	24	1

Idonei ad uso in freezer, lavastoviglie e microonde. Per alimenti, senza BPA. Questa pratica clip è progettata per chiudere ermeticamente (carta o plastica) e mantenere il contenuto fresco per mesi. Grazie alla sua cerniera con memoria brevettata, queste clip hanno dimostrato di potersi aprire e chiudere più di 1.000.000 volte in svariati test a temperature estreme. Queste clip hanno una memoria, se perdono la loro forma è sufficiente immergerle in acqua bollente per un minuto e torneranno alla loro forma originale. Riutilizzabili per anni e anni.
Freezer, dishwasher and microwave safe. Safe to use with food, BPA free. This handy bag clip is designed to tightly close and keep bagged (paper or plastic) contents fresh for months. Thanks to its patented memory hinge, these clips have been shown to open and close more than 1,000,000 times in independent tests while in extreme temperatures. These clips have a memory, if they lose their shape just place in boiling water for a minute and they will return to their original shape. Reusable for years and years.

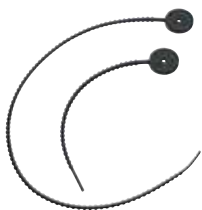

P

Laccetti da cucina, silicone, set 6 pezzi
Foodloops, silicone, 6 pcs set
Silikonbänder, Satz 6 Stk.
Lacets de cuisson, silicone, set 6 pcs.
Lazos de silicona de cocina, juego 6 pz.

art.	l. cm.
51595B44	22
51595B45	53

Laccetto da cucina in alternativa allo spago da cucina. Realizzato in silicone alimentare al 100%. - Silicone kitchen strings as alternative to twine and rope. Made of 100% food-grade silicone.



Presse canard, bronzo
Presse canard, bronze
Presse canard, Bronze
Presse à canard, bronze
Presador para canard, bronce

art.	h. cm.	kg.
49845-01	52	16

Le parti in contatto con gli alimenti sono stagnate. - Parts in contact with food are tinned.



Pressapolipo, inox
 Octopus-press, stainless steel
 Krake-Press, Edelstahl Rostfrei
 Presse à poulpe, inox
 Prensador para pulpo, inox

art.	Ø cm.	h.
49760-00	10,5	20,5

Inserendo la polpa di polipo nel Pressapolipo si otterrà un composto uniforme e compatto. Pratico e facilmente affettabile per poter inventare gustosi piatti e decorazioni uniche.
 Octopus-press to obtain a compact and uniform compound. Practical and easy to slice to invent tasty plates and sole decoration.

Dotazione: A - 1 vite con volantino B - 2 chiavi fermadischi C - 2 tubi inox D - 2 dischi inox E - 2 dischi inox con foro.
 Equipment: A - 1 screw with handwheel B - 2 spanners to lock the discs C - 2 stainless steel cylinders D - 2 stainless steel discs E - 2 stainless steel discs with hole.



1 - Inserire un dischetto inferiore (non forato) all'interno del cilindro. - Put a lower disc (without hole) in the cylinder.



2 - Inserire all'interno del cilindro la polpa di polipo bollito. - Put some boiled octopus in the cylinder.



3 - Inserire il dischetto inferiore forato sopra la polpa di polipo. - Put the upper disc with hole on top of the octopus.

4 - Inserire la vite facendola combaciare con il foro del dischetto superiore. Pressare la polpa di polipo ruotando in senso orario il volantino. Insert the screw matching it with the hole of the upper disc. Then press the octopus by rotating in a clockwise direction the handwheel.



5 - Inserire la chiave fermadischi negli appositi fori. Il composto di polipo è così bloccato tra i due dischetti. Riporre il cilindro nel frigorifero per circa due ore. - Insert the spanner to lock the disc in the appropriate discs. Now the octopus is locked between the two discs. Put the cylinder in the fridge for about two hours.



6 - Estrarre il composto ottenuto dal cilindro e affettare a piacimento per gradevoli decorazioni. - Extract the compound obtained by the cylinder and slice as you like to create pleasant decorations.



Stampi con coperchio, inox
 Yule log moulds with cover, stainless steel
 Pasteten-Formen mit Deckel, Edelstahl Rostfrei
 Gouttières avec couvercle, inox
 Moldes para crema con tapa, inox

art.	dim. cm.	l.	lt.
49762-05	7-8	30,0	1,6
49762-06	5,5x5	27,5	0,5
49762-07	8x7,5	26,0	0,7
49762-08	8x7,5	26,0	0,7





Mini-chitarra, inox
Mini-guitare, stainless steel
Mini-Guitare, Edelstahl Rostfrei
Mini-guitare, inox
Mini guitarra, inox

art.	dim. cm.	h.	kg.
49839-00	45x23	15	4,9

Per prodotti teneri ma di consistenza omogenea. Larghezza taglio 14,5 cm, spessore 5 mm. Lavabile in lavastoviglie. For products with tender and homogeneous consistency. Cut width 14,5 cm, thickness 5 mm. Dishwasher safe.



Taglia cubi, inox
Cube cutter, stainless steel
Würfel-Schneidergerät, Edelstahl Rostfrei
Coupe-cubes, inox
Cortador en dados, inox

art.	dim. cm.	h.	kg.
49821-08	35,5x26	66	4

Spessore taglio 8 mm, disponibile kit da taglio 10 mm. - Dice thickness 8 mm, available blade assembly dice thickness 10 mm.



Affetta pomodori, inox
Tomato cutter, stainless steel
Tomatenschneidergerät, Edelstahl Rostfrei
Coupe-tomates, inox
Cortador tomates, inox

art.	dim. cm.	h.	kg.
49837-05	30x14	18	2

Spessore taglio 5,5 mm, lavabile in lavastoviglie. - Slice thickness 5,5 mm, dishwasher proof.



Affetta pomodori, ABS - inox
Tomato cutter, ABS - stainless steel
Tomatenschneidergerät, ABS - E. R.
Coupe-tomates, ABS - inox
Cortador tomates, ABS - inox

art.	dim. cm.	h.	kg.
49837-01	28,5x13	16	0,8

Spessore taglio 5,5 mm, lavabile in lavastoviglie. - Slice thickness 5,5 mm, dishwasher proof.



Taglia verdure manuale, inox
Manual vegetable cutter, stainless steel
Gemüseschneider, Edelstahl Rostfrei
Machine à tourner les légumes, inox
Cortador de verduras manual, inox

art.	dim. cm.	h.	kg.
49842-00	21x17,5	19	3,2

Per ottenere patate chateau, cotte e fondenti di lunghezza da cm. 4 a 8 con 7 facce regolari. Lama con 3 regolazioni di taglio. Posizione supporto regolabile. La macchina può essere utilizzata da personale non qualificato. Costruzione in acciaio inox, facile da pulire. Base stabile con 4 piedini a ventosa. - To make easily chateau potatoes, cooked and fondants with a length from 4 to 8 cm. having 7 regular faces. 3 position adjustable blade. Adjustable position of the carriage support. Can be used by a non qualified personal. Made in stainless steel, easy cleaning. Stability base with 4 suction feet. suction feet.



Trancia spicchi, inox
Fruit cutter, stainless steel
Früchtenschneider, Edelstahl Rostfrei
Coupe-fruits, inox
Cortador tomates, inox

art.	dim. cm.	h.	kg.
49838-08	38x26	58	3,3



8 spicchi, per ortaggi e frutta senza nocciolo. Lavabile in lavastoviglie. 8 wedges, for vegetables and fruits without stone. Dishwasher proof.



Set lame levatorsolo e trancia spicchi
Apple corer/wedger set of blades
Apfelentkerner-/Schneidmesser
Lames évideur/coupe-pommes
Saca corazón y cortador para manzanas

art.
49838-98



Pela carote/verdure
Long/thin vegetable-peeler
Gemüseschäler
Eplucheur à légumes
Pelador sobre base

art.	dim. cm.	h.	kg.
49819-00	14x17	50	1,9

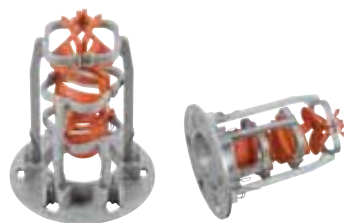

Accessori opzionali per pela verdure
Additional peelingheads
Schälkopf-Zusatzteile
Têtes supplémentaires pour eplucheur
Cabezas suplementarios para pelador

art.	
49819-01	carote/carrots
49819-02	carote grosse/big carrots



Pela/svuota ananas, inox
Pineapple-peeler/corer, stainless steel
Ananasschälmaschine, Edelstahl
Epluche-ananas, inox
Pelador de piña, inox

art.	dim. cm.	h.	kg.
49818-00	45x39	72	18

Lama e pressatore in dotazione ø 89 mm.
Equipped with blade and pusher ø 89 mm.



Taglia ananas, inox
Pineapple slicer, stainless steel
Ananasteiler, Edelstahl Rostfrei
Coupe-ananas en rondelle, inox
Cortador de piña en rondajas, inox

art.	l. cm.	ø mm.
48218-00	24	25



Svuota ananas, inox
Pineapple coring tool, stainless steel
Ananasausstecher, Edelstahl Rostfrei
Vide ananas, inox
Saca corazón de piña, inox

art.	ø mm.	l. cm.
48280-10	25	24



Pressatori e lame opzionali
Additional pushers and blades
Zusätzliche Presse und Messer
Poussoirs et couteaux supplémentaires
Empujador y cuchilla suplementarios

art.	ø mm.	
49818-AC	74	lama/blade
49818-AD	74	pressatore/pusher
49818-AE	102	lama/blade
49818-AF	102	pressatore/pusher



Pelatrice elettrica
Electric peeler
Elektr. Schälmaschine
Eplucheur électrique
Pelador eléctrico

art.	dim. cm.	h.	kg.
49750-00	25x16	21,5	2

Ideale per arance, limoni, pompelmi, kiwi, pomodori, pesche, ecc. 230 V.
To peel citrus, kiwis, tomatoes, peaches, grape-fruits, etc. 230 V.



Pela mele professionale
Professional apple peeler
Profi-Apfelschäler
Pèle-pommes, professionnel
Pelador de manzanas, profesional

art.	dim. cm.	h.	kg.
49834-00	32x14	10	1,9

Per pelare e tagliare mele e agrumi.
To peel and slice apples and citrus fruits.



Motore per pela mele art. 49834
Apple peeler motor for item 49834
Motor für Apfelschäler Art.-Nr. 49834
Moteur pour pèle-pommes réf. 49834
Motorización para artículo 49834

art.	V
49834-10	3,6



Pela arance con morsetto
Orange peeler with screw
Orangenschäler, Tischklemme
Pèle-orange, socle serre-joint
Pelador de naranjas, fijación brida

art.	dim. cm.	h.
49817-00	30x10	15



Pela mele con morsetto
Apple peeler with screw
Apfelschäler, Tischklemme
Pèle-pommes, socle serre-joint
Pelador de manzanas, fijación brida

art.	dim. cm.	h.
49835-00	30x10	17



Pela mele con ventosa
Apple peeler, vacuum-power base
Apfelschäler, Vakuum-Fuss
Pèle-pommes, socle vacuum
Pelador de manzanas, fijación ventosa

art.	dim. cm.	h.
49836-00	30x10	13



Tagliaverdure ghirlanda, inox
Potato twist cutter, stainless steel
Kartoffeln-Spiralschneider, E.R.
Machine à brochette, inox
Coratador de verduras, inox

art.	dim. cm.	h.	kg.
49843-00	33x13	45	3,4

Spessore taglio 2,5 mm.
Slice thickness 2,5 mm.



Trancia spicchi per mela, inox
Apple corer/wedger, stainless steel
Apfelentkerner-/Schneider, Edelstahl
Lames évident/coupe-pommes, inox
Cortador y descorazonador manzanas, inox

art.	ø cm.
48289-10	10

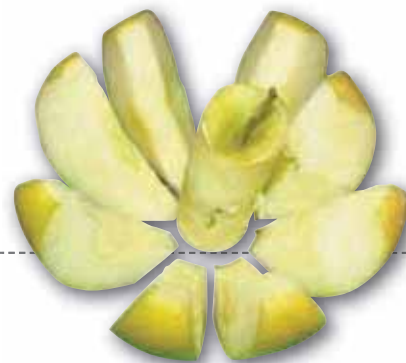

Taglia uova, inox
Egg slicer, stainless steel
Eierteiler, Edelstahl Rostfrei
Tranche-oeufs, inox
Cortahuevos, inox

art.	ø cm.	l.
42597-00	6,5	21



Apriuovo, inox
Egg knocker, stainless steel
Eierköpfer, Edelstahl Rostfrei
Toque oeuf, inox
Abridor de huevos, inox

art.	ø cm.	l.
42595-01	3,2	11



Taglia uova
Egg-slicer
Eierteiler
Tranche-oeufs
Cortahuevos doble uso

art.	dim. cm.	h.
42588-00	21x8	4,5



Taglia uova, alluminio
Egg-slicer, aluminum
Eierteiler, Aluminium
Tranche-oeufs rondelle, aluminium
Cortahuevos guitarra, aluminio

art.	dim. cm.	h.
42588-01	13,5x8	4,5



Contenitore per uova
Egg container
Eier-Behälter
Porte-oeufs
Contenedor para huevos

art.	dim. cm.	h.
47093-24	30x21,5	6,5



Contenitore per uova, acrilico
Egg container, acrylic
Eier-Behälter, Acryl
Porte-oeufs, acrilique
Contenedor para huevos, acrílico

art.	dim. cm.	h.
44947-07	15x20	5



P

Anelli per uova, inox
Egg rings, stainless steel
Eierringe, Edelstahl Rostfrei
Ronds à oeufs, inox
Anillos para huevos, inox

art.	ø cm.	u.pack
42596-02	8	2



Anello per uova, antiaderente
Egg ring, non stick
Eierring, beschichtet
Rond à oeufs, anti-adhésif
Anillo para huevos, antiaderente

art.	ø cm.	h.
42650-10	10	1,5



P

Anelli per uova, set 4 pz., inox
Egg rings, set 4 pcs., stainless steel
Eierringe, Satz 4 Stk., Edelstahl Rostfrei
Ronds à oeufs, set 4 pcs., inox
Anillos para huevos, 4 piezas, inox

art.	ø cm.
42651-10	10



Anello per uova, antiaderente
Egg ring, non stick
Eierring, beschichtet
Rond à oeufs, anti-adhésif
Anillo para huevos, antiaderente

art.	ø cm.	h.
42650-11	11	1,5



Taglia funghi, inox
Mushroom cutter, stainless steel
Pilze-Teiler, Edelstahl Rostfrei
Tranche-champignons, inox
Cortador de hongas, inox

art.	ø cm.	l.
42598-00	7,6	20,7



Pela/taglia avocado, inox
Avocado peeler and slicer, s/s
Avocadoschäler-/teiler, Edelstahl
Pèle et tranche avocat, inox
Pelador y cortador de aguacete, inox

art.	l. cm.
48286-62	18,5



Pela anguria /zucca, inox
Watermelon/pumpkin peeler, s/s
Wassermelone u. Kürbis-Schäler, E. R.
Eplucheur pastèque/potiron, inox
Pelador de sandía y calabaza, inox

art.	dim. cm.
48286-63	16x10



Pelaverdure, inox
Large vegetable slicer, stainless steel
Gemüseschäler, Edelstahl Rostfrei
Eplucheur à légumes, inox
Pelador de verduras, inox

art.	dim. cm.
48286-64	22x10



Pelapatate
Potato peeler
Sparschäler
Eplucheur
Pelador de patatas

art.	dim. cm.
42589-00	5x4



Schiacciapatate 3 griglie, inox
Potato ricer with 3 discs, stainless steel
Kartoffelpresse, 3 Roste, Edelstahl
Presse-purée 3 grilles, inox
Pasapurés, 3 discos, inox

art.	dim. cm.	h. cm.	ø cm.	discs ø mm.
42566-03	30x10	11	8,5	2,4-4,4-6,5



Taglia patate, inox
French fry cutter, stainless steel
Kartoffelschneidergerät, Edelstahl Rostfrei
Coupe-frites, inox
Cortador de patatas fritas, inox

art.	dim. cm.	h.	kg.
49832-10	24x44	34	11

Quadro di taglio 10 mm. Su richiesta 8 e 6 mm. - 10 mm cutting knife. Upon request 8 & 6 mm.



Taglia patate, inox
French fry cutter, stainless steel
Kartoffelschneidergerät, Edelstahl Rostfrei
Coupe-frites, inox
Cortador de patatas fritas, inox

art.	dim. cm.	h.	kg.
49832-02	26x9	12,5	1,2

2 quadri di taglio 9x9 mm e 12x12 mm.
2 cutting knives 9x9 mm & 12x12 mm.



Grattugia formaggio rotatoria
Cheese rotary grater
Drehe-Käse-Raffel
Frisette à fromage
Ralladora giratoria para queso

Cloche per grattugia rotatoria
Rotary grater cover
Käse-Raffel-Haube
Cloche à frisette
Tapa para ralladora

art.	ø cm.	h.	gr.
48281-22	22	16	250

art.	ø cm.	h.
48281-23	15,5	11

Base legno. - Wood base.



Forbice per erbe, 5 lame
Herb scissors
Kräuterschere
Ciseaux à herbes
Tijeras hierbas

Taglia/snocciola mango
Mangoteiler and seed remover
Mangoteiler u. Entkerner
Coupe-dénoyateur de mangue
Cortador y descorazonador de mangos

Taglia mango
Mango cutter
Mangoteiler
Coupe mangue
Cortador de mangos

art.	l. cm.
18277-00	10

art.	dim. cm.	gr.
48286-65	21,5x13,5	105

art.	dim. cm.	h.	gr.
48286-66	10,5x10	17,5	470



Grattugia automatica
Grater, automatic
Raffel, automatisch
Râpe automatique
Rallador automático

art.	dim. cm.	gr.
48295-10	20x5,4	360



Dotazione: recipiente ermetico, contenitore removibile con coperchio, 2 lame. Ideale per formaggio, noci, cioccolato, ecc. Funzionamento con 4 pile alcaline LR6 AA. - Equipment: hermetic container, removable container with lid, 2 blades. Ideal for cheese, nuts, chocolate. etc. Powered by 4 alkaline batteries LR6.



Taglia tortillas, inox
Tortillas wedger, stainless steel
Tortillasteiler, Edelstahl Rostfrei
Coupe-tortillas, inox
Corta tortillas, inox

art.	Ø cm.	
42599-06	25	6 parti/wedges
42599-08	25	8 parti/wedges



Lira per formaggi, inox
Cheese wire cutter, stainless steel
Käse Drahtschneider, Edelstahl Rostfrei
Lyre à fromage, inox
Lira para quesos, inox

art.	dim. cm.
48282-21	20,5x26,7



Spremiaglio, inox
Garlic press, stainless steel
Knoblauchpresse, Edelstahl Rostfrei
Presse-ail, inox
Prensador de ajo, inox

art.	Ø cm.
42565-00	2,7



Snocciolatore, cromato
Olive seed remover, chromed
Olivenentsteiner, verchromt
Dénoyauteur, chromé
Quita pepa/hueso, cromado

art.	l. cm.
42563-00	17



Snocciolatore
Cherry core stripper
Kirschenentsteiner
Dénoyauteur de cerises
Quita pepa/hueso

art.	Ø cm.	h.
42563-44	10	34



Mandolino, inox
Mandoline, stainless steel
Gemüsehobel Mandoline, Edelstahl
Mandoline, inox
Mandolina, inox

art.	dim. cm.	h.	kg.
49829-11	39x12,5	5,5	1,7



Mandolino Grand Gourmet, inox
Slicer Mandoline, Grand Gourmet, s/s
Gemüsehobel Grand Gourmet, Edelstahl
Mandoline Grand Gourmet, inox
Mandolina Grand Gourmet, inox

art.	dim. cm.	h.	kg.
49830-60	40x12	28	1,6

Dotato di 38 lame, 10 mm, su richiesta kit di taglio da 4,5 e 7 mm. - Equipped with 38 blades, 10 mm, available upon request 4,5 & 7 mm. spare assemblies.



Mandolino, inox
Mandoline, stainless steel
Gemüsehobel Mandoline, Edelstahl
Mandoline, inox
Mandolina, inox

art.	dim. cm.	h.	kg.
49752-00	33,5x11	2,3	0,6

Dotato di 3 lame intercambiabili da 2-3-6 mm. - Equipped with 3 interchangeable blades, 2-3-6 mm.

Dotato di 7 lame intercambiabili.
Equipped with 7 interchangeable blades.

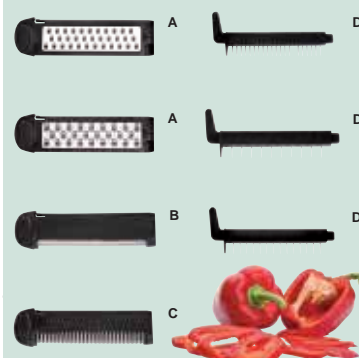

Il set di lame include due lame a grattugia (A), una lama a filo dritto (B), una lama a filo ondulato (C) e 3 lame da julienne con diverso spessore (D).

The blade set includes two grating blades (A), a straight edge master blade (B), a "crinckle" edge master blade (C) and 3 different width julienne blades (D).



Mandolino giapponese, ABS
Japanese Mandoline slicer, ABS
Japanese Gemüsehobel, ABS
Mandoline japonaise, ABS
Mandolina japonés, ABS

art.	dim. cm.	h.	kg.
49753-06	11x31,5	3,0	0,3
49753-09	15x35	3,3	0,5

Dotato di 1 lama liscia e 3 lame da 1-2-3 mm. - Equipped with 1 plain blade and 3 blades of 1-2-3 mm.



Mandolino automatico
Mandoline, automatic
Gemüsehobel Mandoline, automatisch
Mandoline automatique
Mandolina automática

P

art.	dim. cm.	h	gr.
48295-11	28,4x10,2	19,4	660

Dotato di 1 lama Julienne e 3 lame lisce.
Equipped with 1 julienne and 3 plain blades.



Taglia cipolla a fiore
Blossom onion cutter
Zwiebel-blumenschneider
Coupe-oignon en fleurs
Cortador de cebollas en flores

art.	ø cm.
48216-10	9,5



Intaglia verdure, inox
Cutter/corer, stainless steel
Ausstechforme, Edelstahl Rostfrei
Découpoir, inox
Sacabocados, inox

art.	dim. cm.	h.
48286-70	3,7x8,5	9

Diametro di taglio 3,4 cm.
Cutting diameter 3,4 cm.



Tagliaverdura turn'up, inox
Cutter turn'up, stainless steel
Ausstechforme Turn'Up, Edelstahl Rostfrei
Découpoir pour fonds à garnir
Descorazonador-vaciador turn'up, inox

art.	ø cm.	h.
48285-04	4	14,5
48285-05	5	14,5



Set decoro 4 pezzi, inox
Decoration kit, 4 tools, stainless steel
Dekoriersatz, 4-Tlg.
Kit 3 tubes découpoirs + 1 poussoir, inox
Juego 4 herramientas de decoración, inox

art.	ø mm.	h.
48286-72	10-15-20	100



Set decoro 8 pezzi, inox
Decoration kit, 8 tools, stainless steel
Dekoriersatz, 8-Tlg.
Kit 5 tubes découpoirs + 3 poussoirs, inox
Juego 8 herramientas de decoración, inox

art.	ø mm.	h. mm.
48286-71	5-10-15-20-25	130



Per creare combinazioni insolite di frutta, verdura, pane, formaggi... spiedini originali, dalla grafica colorata.
To create unusual combinations of fruits, vegetables, bread, cheese... original colorful skewers.



Taglia verdure, plastica
Spiral Vegetable Slicer tri-Blade, plastic
Gemüseschneider, Kunststoff
Coupe légumes, plastique
Cortador de verduras, plástico

P

Dotato di tre lame intercambiabili in acciaio inox (3 mm, 6 mm e una lama dritta per taglio a nastro). Supporto dotato di rebbi per fissare al meglio verdura e frutta. Maneggevole nell'utilizzo e semplice da pulire. Ideale per realizzare julienne, chips, riccioli, anelli e fette sottili di verdura e frutta. - Equipped with three interchangeable blades made of stainless steel (3 mm, 6 mm and a straight blade for ribbon cuts). Wheel with prongs to easily secure vegetables and fruits. Versatile and easy to clean. Ideal for making julienne cuts, chips, spiral shapes, rings and plain slices of vegetables and fruits.

art.	dim. cm.	h.
49827-99	30x14	22



Taglia verdure 4-lame, plastica
Turning slicer 4-blades, plastic
Gemüseschneider, Kunststoff
Coupe légumes, plastique
Cortador de verduras, plástico

P

art.	dim. cm.	h.
49826-99	15,5x25	15



Stoccaggio sicuro e compatto. Multi-funzionale 4 lame - per affettare (2,5 mm), fine (3x3mm) e grossa (4x6mm) per tritatore e capelli d'angelo (1,2x2mm). Per fare svariati tipi di spirale e tagli, sminuzzare, tagliatelle, anelli, chip, ecc. Ideale per patate, zucchine, carote, ravanelli, mele, cavoli, ecc. Perno per fare spiedini a spirale. Il coperchio può essere utilizzato come vassoio. Pressatore adatto sia per ambidestri che per mancini. - Foldable turning slicer, easy assembly, safe and compact storage. Multi-functional 4 blades - slicer (2,5mm), fine (3x3mm) and coarse (4x6mm) shredder and angel hair (1,2x2mm). Make many kinds of spiral slicing & shredding such as noodles, rings, curvy chips & twist. Works great with potatoes, zucchini, carote, radishes, apples and cabbages etc. Bonus pin for making spiral cut skewers with slicer blade. Storage cover can be used as food tray. Pusher adapts both left & right hand users.



Taglia verdure, plastica
Spiral Vegetable Slicer, plastic
Gemüseschneider, Kunststoff
Coupe légumes, plastique
Cortador de verduras, plástico

P

art.	ø cm.	h.
49825-05	8	15





Taglia verdure, inox
Strip slicer, stainless steel
Gemüseschneider, Edelstahl Rostfrei
Coupe-lanières, inox
Cortador de verduras japonés, inox

art.	dim. cm.	h.	kg.
49823-00	20x20	20	1,9

Lavabile in lavastoviglie. Blocco di taglio da 1,5 mm. Lunghezza max verdura 11 cm. ø max 17 cm. - Dishwasher safe. Cutting block 1,5 mm. Max vegetables length 11 cm. Max ø 17 cm.



Taglia verdure, plastica
Strip slicer, plastic
Gemüseschneider, Kunststoff
Coupe lanière, plastique
Cortador de verduras, plástico

art.	dim. cm.	h.
49823-89	24x23	18

Lama inox. Larghezza taglio 15 cm.
Equipped with stainless steel blade.
Width of cut 15 cm.



Taglia verdure, plastica
Strip & spaghetti slicer, plastic
Gemüseschneider, Kunststoff
Coupe lanière et spaghetti, plastique
Cortador de verduras japonés, plástico

art.	dim. cm.	h.
49823-99	24x23	18

Lame reversibili in acciaio inox per tagliare a bande o a spaghetti. Larghezza del taglio 10 cm. - Stainless steel reversible blades to cut vegetables in stripes or spaghetti. Width of cut 10 cm.



Taglia verdure LE ROUET GOURMET
Vegetable cutter
Gemüseschneider
Coupe légumes
Cortador de verduras

art.	dim. cm.	h.	kg.
49827-03	13,5x36	24,3	2,4

Dotato di set di taglio da 1-2-4 mm. Disponibili set di taglio da 7 mm. Equipped with cutting blocks 1-2-4 mm. Available cutting block 7 mm.



Set 2 cucchiari decorazione
Set 2 decorating spoons
Satz 2 Dekoration-Löffel
Set 2 cuillères pour décorer
2 cucharas para decoración

art.	dim. cm.
47831-02	22,5x6,5x2 - 25,5x9x3,5

Per decorazioni su piatti con salse, panna, caramello, purea, ecc., ecc. Piccolo per preparazioni dolci, grande per salate. - To make decorations on dishes with sauces, cream, caramel, puree, etc. Small spoon to decorate sweets, a larger one for savory preparations.



Decora verdure, ghirlanda
Vegetable decorating tool
Dekoriergerät
Decò guirlande
Decorador guirlanda

art.	l. cm.
48284-00	15,5



Decora verdure, spirale
Vegetable decorating tool
Dekoriergerät
Decò spiral
Decorador espiral

art.	ø cm.	l.
48283-00	1,3	23,5
48283-01	1,0	23,5
48283-02	0,7	23,5



Decora verdure, spirale
Vegetable decorating tool
Dekoriergerät
Decò spiral
Decorador espiral

art.	l. cm.
48283-03	23,5
48283-04	23,5
48283-05	23,5



Kit 4 attrezzi decoro
4 fluted chisel set
Dekoriersatz, 4-Tlg.
Lot 4 gouges cannelées
Juego de 4 cinceladores estriados

art.
48286-05



Stiletto thailandese
Thai knife
Thai-Messer
Styilet thai
Cuchillo thai

art. l. cm. lama/blade
48286-08 16 5



Kit 18 attrezzi decoro
Kit of 18 decoration tools
Dekoriersatz, 18-Tlg.
Kit 18 outils de décor
Kit de 22 herramientas decoración

art.
48286-03



Pochette attrezzi decoro, 22 pezzi
Decoration case, 22 tools
Dekoriersatz, 22-Tlg.
Pochette 22 outils décor
Estuche de 22 herramientas decoración

art. dim. cm kg.
48286-13 38,5x29 0,395



Valigia attrezzi decoro, 45 pz.
Decoration case, 45 tools
Dekorierkoffer, 45 -Tlg.
Mallette 45 outils décor
Maletín de 45 herramientas de decoración

art. dim. cm. kg.
48286-18 40x32x10,5 2,8



Valigia attrezzi decoro, 26 pezzi
Decoration case, 26 tools
Dekorierkoffer, 26-Tlg.
Mallette 26 outils décor
Maletín de 26 herramientas decoración

art. dim. cm. kg.
48286-01 32,5x27,5 1



UTENSILI KITCHEN UTENSILS



Coltello ghiaccio
Ice knife
Eis-Messer
Couteau à glace
Cuchillo para hielo

art.	l. cm.	kg.
47885-01	25	0,12



Scalpello ghiaccio a V
V shape chisel
Eismeissel
Ciseau à glace
Cinsel a V para hielo

art.	l. cm.	kg.
47885-02	31,5	0,28



Scalpello ghiaccio 3 lati smussati
Medium flat chisel
Eismeissel
Ciseau à glace
Cinsel para hielo

art.	l. cm.	kg.
47885-03	50	0,45



Scalpello ghiaccio un lato smussato
Big flat chisel
Eismeissel
Ciseau à glace
Cinsel para hielo

art.	l. cm.	kg.
47885-04	74,5	0,78



Set 4 pezzi scalpelli ghiaccio
Four pieces ice chisel set
Eismeissel set 4 Stück
4 pcs set ciseau à glace
Cinseles para hielo, 4 piezas

art.
47885-05



Mantecatore per burro
Butter churn
Butterfaß
Baratte à beurree
Mantequera

art.	dim. cm.	lt.
48294-01	11,5x11,5x40	1,6



Immergere lo stampo chiuso in un contenitore con acqua fredda per almeno 10 minuti per impregnare bene il legno. Mettere il burro appena realizzato nello stampo e conservare in frigorifero per un paio d'ore finché non sarà compatto. - Soak the mold in cold water for 10 minutes to well impregnate the wood. Put the butter just realized in the mold and refrigerate for a few hours until it becomes compact.



5x7,5 cm.

Stampo per burro, ovale, fiore
Butter mold, oval, flower
Butterform, oval, Blume
Moule à beurree, oval, fleur
Molde para mantequilla, oval, flor

art.	dim. cm.	h.	por.
48294-02	12,2x6,6	4,3	gr 80



ø 7 cm.

Stampo per burro, tondo, mucca
Butter mold, round, cow
Butterform, rund, Kuh
Moule à beurree, rond, vache
Molde para mantequilla, redondo, vaca

art.	dim. cm.	h.	por.
48294-03	15,8x9	5,0	gr 125



13x6,5 cm.

Stampo per burro, ovale, fiore
Butter mold, oval, flower
Butterform, oval, Blume
Moule à beurree, oval, fleur
Molde para mantequilla, oval, flor

art.	dim. cm.	h.	por.
48294-04	21x9,4	5,8	gr 250



Grattugia inox, manico antiscivolo
Grater, stainless steel, non-slip handle
Raffel, Edelstahl Rostfrei, Rutschfestes Griff
Râpe inox, queue antidérapant
Rallador inox, mango antiderrapante

art.	dim. cm.	l.
42560-01	4x22	38,5



Grattugia inox, manico antiscivolo
Grater, stainless steel, non-slip handle
Raffel, Edelstahl Rostfrei, Rutschfestes Griff
Râpe inox, queue antidérapant
Rallador inox, mango antiderrapante

art.	dim. cm.	l.
42560-02	4x22	38,5

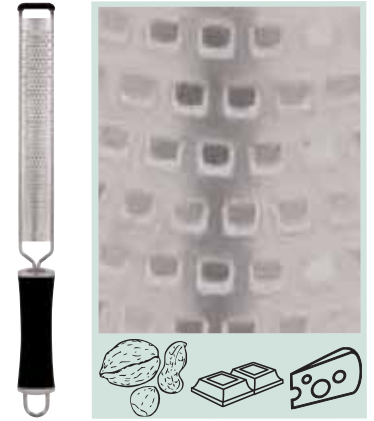

Grattugia inox, manico antiscivolo
Grater, stainless steel, non-slip handle
Raffel, Edelstahl Rostfrei, Rutschfestes Griff
Râpe inox, queue antidérapant
Rallador inox, mango antiderrapante

art.	dim. cm.	l.
42560-03	4x22	38,5



Grattugia inox, manico antiscivolo
Grater, stainless steel, non-slip handle
Raffel, Edelstahl Rostfrei, Rutschfestes Griff
Râpe inox, queue antidérapant
Rallador inox, mango antiderrapante

art.	dim. cm.	l.
42560-04	7,7x13,3	30



Grattugia inox, manico antiscivolo
Grater, stainless steel, non-slip handle
Raffel, Edelstahl Rostfrei, Rutschfestes Griff
Râpe inox, queue antidérapant
Rallador inox, mango antiderrapante

art.	dim. cm.	l.
42560-05	7,7x13,3	30



Grattugia inox, manico antiscivolo
Grater, stainless steel, non-slip handle
Raffel, Edelstahl Rostfrei, Rutschfestes Griff
Râpe inox, queue antidérapant
Rallador inox, mango antiderrapante

art.	dim. cm.	l.
42560-06	7,7x13,3	30

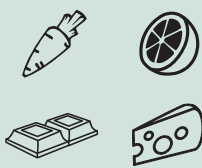

Grattugia inox, manico antiscivolo
Grater, stainless steel, non-slip handle
Raffel, Edelstahl Rostfrei, Rutschfestes Griff
Râpe inox, queue antidérapant
Rallador inox, mango antiderrapante

art.	dim. cm.	l.
42560-07	7,7x13,3	30



Grattugia inox, manico antiscivolo
Grater, stainless steel, non-slip handle
Raffel, Edelstahl Rostfrei, Rutschfestes Griff
Râpe inox, queue antidérapant
Rallador inox, mango antiderrapante

art.	dim. cm.	l.
42560-08	7,7x13,3	30



Grattugia inox, manico antiscivolo
Grater, stainless steel, non-slip handle
Raffel, Edelstahl Rostfrei, Rutschfestes Griff
Râpe inox, queue antidérapant
Rallador inox, mango antiderrapante

art.	dim. cm.	l.
42560-09	7,7x13,3	30

UTENSILI KITCHEN UTENSILS



Grattugia per spatule, inox
Spatzle sieve, s/s
Spätzle-Raffel, Edelstahl Rostfrei
Grille à spätzle, inox
Rallador para spätzle, inox

art.	dim. cm.	h.
49844-01	31x10,5	6



Grattugia noce moscata, inox
Nutmeg grater, s/s
Muskatrafel, Edelstahl Rostfrei
Râpe à muscade, inox
Rallador nuez moscada, inox

art.	dim. cm.
42556-00	4,5x14



Grattugia 4 tagli, inox
4-ways grater, s/s
Raffel, Edelstahl Rostfrei
Râpe, inox
Rallador, inox

P

art.	dim. cm.	h.
42569-04	10x8	23



Grattugia a tamburo
Rotary grater
Trommelreibe
Râpe rotative
Rallador rotativo

art.	dim. cm.	h.	kg.
49756-00	16x22	45	2,4

Dotata di 3 tamburi: verdure, parmigiano e gruyère. - Equipped with 3 drums: vegetables, parmesan, gruyère cheese.



Stampo panzerotti
Dumplin maker
Knödel-Form
Moule à chausson
Molde para empanadillas

art.	tagli/cuts mm.
49843-05	62 - 82 - 104 - 177



RAVIOLI Stampo, alluminio
Mould, aluminum
Formen, Aluminium
Moule, aluminium
Molde, aluminio

art.	dim. mm.	pz/pcs
49840-30	34x34	24
49840-31	34x34	36

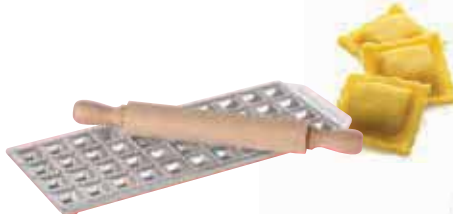

RAVIOLI da BRODO Stampo, alluminio
Mould, aluminum
Formen, Aluminium
Moule, aluminium
Molde, aluminio

art.	dim. mm.	pz/pcs
49840-32	25x25	44

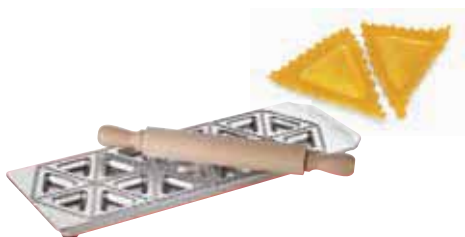

TORTELLI Stampo, alluminio
Mould, aluminum
Formen, Aluminium
Moule, aluminium
Molde, aluminio

art.	dim. mm.	pz/pcs
49840-33	60x60x60	18



RAVIOLI CHEF Stampo, alluminio
Mould, aluminum
Formen, Aluminium
Moule, aluminium
Molde, aluminio

art.	dim. mm.	pz/pcs
49840-34	52x52	12



Sfogliatrice manuale
Noodle machine
Nudelschneidmaschine
Coupe-nouilles
Máquina de pasta

art.	dim. cm.	h.	kg.
49840-00	30x22	25	9,8

Tagliasfoglia da ordinarsi separatamente.
Cutting rollers to be ordered separately.



Sfogliatrice elettronica
Electronic pasta machine
Elektrischer Teigausroller
Machine à abaisse électronique
Máquina para hojaldrar electrónica

art.	dim. cm.	h.	kg.
49841-00	31x26	29,5	18,3

230V/50Hz 290W - Velocità di rotazione rulli da 5 a 100 giri/max. Campo di regolazione 0-5 mm. Produzione sfoglia 12 kg/h. Larghezza sfoglia 210 mm. Tagliasfoglia da ordinarsi separatamente. Rotational speed of the rollers from 5 to 100 max. Rollers setting range 0-5 mm. Pasta output 12kg/h. Pasta sheet width 210 mm. Cutting rollers to be ordered separately.



Sfogliatrice elettrica
Electric pasta machine
Elektrischer Teigausroller
Machine à abaisse électrique
Máquina para hojaldrar eléctrica

art.	dim. cm.	h.	kg.
49849-00	30x22	25	14,8

230V/50Hz 290W - Velocità di rotazione rulli 45 giri/min. Campo di regolazione 0-5 mm. Produzione sfoglia 12 kg/h. Larghezza sfoglia 210 mm. Tagliasfoglia da ordinarsi separatamente - Rotational speed of the rollers 45 per min. Rollers setting range 0-5 mm. Pasta output 12kg/h. Pasta sheet width 210 mm. Cutting rollers to be ordered separately.



Tagliasfoglia
Cutting roller
Schneidwalzen
Cylindres de coupe
Cortador de pasta

art.	mm.	
49840-02	2	tagliatelle



Tagliasfoglia
Cutting roller
Schneidwalzen
Cylindres de coupe
Cortador de pasta

art.	mm.	
49840-03	1,5	capelli d'angelo



Tagliasfoglia
Cutting roller
Schneidwalzen
Cylindres de coupe
Cortador de pasta

art.	mm.	
49840-04	4	trenette



Tagliasfoglia
Cutting roller
Schneidwalzen
Cylindres de coupe
Cortador de pasta

art.	ø mm.	
49840-05	2	spaghetti



Tagliasfoglia
Cutting roller
Schneidwalzen
Cylindres de coupe
Cortador de pasta

art.	mm.	
49840-06	6,5	fettuccine



Tagliasfoglia
Cutting roller
Schneidwalzen
Cylindres de coupe
Cortador de pasta

art.	mm.	
49840-07	12	reginette



Tagliasfoglia
Cutting roller
Schneidwalzen
Cylindres de coupe
Cortador de pasta

art.	mm.	
49840-01	12	lasagnette



Stendipasta
Pasta drying rack
Nudel-Trockner
Séchoir à pâtes
Tendedero para pasta

art.	dim. cm.
49840-20	33x37x37



Costruito in faggio evaporato consente di stendere più di 1 kg di pasta. - Made of evaporated beechwood you can hang over 1 kg of pasta.



Apriscatole sicuro
Safety can opener
Sicherheitsdosenöffner
Ouvre-boîte de sûreté
Abrelatas de seguridad

art. dim. cm.
48222-01 12,5x8



Apriscatole universale, nichelato
Universal can opener
Universal-Dosenöffner
Ouvre-boîte, universel
Abrelatas universal

art. dim. cm.
48220-00 5x7



Apriscatole, impugnatura PP
Can opener, PP handle
Dosenöffner, Griffe aus PP
Ouvre-boîte, poignées PP
Abrelatas, mango PP

art. l. cm.
48280-03 21



Passaverdura elettrico, inox
Electric sieve, stainless steel
Elektropassiergerät, Edelstahl Rostfrei
Moulin électrique, inox
Molino eléctrico, inox

art. ø cm. h. kg. W
49879-37 37 108 23,5 600

Resa: 5kg/mn. Motore trifase 380V.
Griglia in dotazione 3 mm. - Flow
rate: 5kg/mn. Threephase motor 380V.
Equipped with 3 mm disc.



Passaverdura stagnato con supporto
Sieve on tripod, tinned
Passiergerät, verzinkt, mit Träger
Moulin étamé sur pied
Molino estañado sobre pie

art. ø cm. h. kg.
42577-39 39 80 14

Griglia in dotazione 3 mm.
Equipped with 3 mm disc.



Passapomodori, professionale
Tomato juicer sieve
Profi-Tomatenpassiergerät
Moulin à tomates professionnel
Molino para tomates, profesional

art. ø cm. h.
42576-00 21 50

Griglia in dotazione 1 mm.
Equipped with 1 mm disc.



Macinaerbe, inox
Herb mill, s/s
Kräutermühle, Edelstahl Rostfrei
Moulin fines herbes, inox
Molino de hierbas finas, inox

art. dim. cm.
42558-00 7x22



Passaverdura inox, 3 griglie
Sieve, stainless steel, 3 discs
Passiergerät, Edelstahl Rostfrei, 3 Roste
Moulin inox, 3 grilles
Molino inox, 3 rejillas

art. ø cm. h. kg.
42571-20 19 16,5 0,46

Griglie/Discs: 1,5 - 2 - 4 mm.



Passaverdura inox, 3 griglie
Sieve, stainless steel, 3 discs
Passiergerät, Edelstahl Rostfrei, 3 Roste
Moulin inox, 3 grilles
Molino inox, 3 rejillas

art. ø cm. h. kg.
42572-24 24 16,5 0,82



Passaverdura inox, 3 griglie
Sieve, stainless steel, 3 discs
Passiergerät, Edelstahl Rostfrei, 3 Roste
Moulin inox, 3 grilles
Molino inox, 3 rejillas

art.	ø cm.	h.	kg.
42570-32	31	25	1,4

Griglie/Discs: 1,5 - 2,5 - 4 mm.



Passaverdura stagnato, 3 griglie
Sieve, tinned, 3 discs
Passiergerät, verzinkt, 3 Roste
Moulin étamé, 3 grilles
Molino estañado, 3 rejillas

art.	ø cm.	h.	kg.
42573-31	31	25	1,4



Passaverdura inox, 1 griglia
Sieve, stainless steel, 1 disc
Passiergerät, Edelstahl Rostfrei, 1 Rost
Moulin inox, 1 grille
Molino inox, 1 rejilla

art.	ø cm.	h.	kg.
42574-37	37	32	3,5

Griglia/Disc: 3 mm.



Passaverdura stagnato, 1 griglia
Sieve, tinned, 1 disc
Passiergerät, verzinkt, 1 Rost
Moulin étamé, 1 grille
Molino estañado, 1 rejilla

art.	ø cm.	h.	kg.
42575-37	37	32	3,5

Griglia/Disc: 3 mm.



Griglie per art.
Discs for item
Roste für Art.-Nr.
Grilles pour réf. 42577 - 49879
Rejillas para art. 42574 - 42575

art.	mm.
-90	1,0
-91	1,5
-92	2,0
-93	3,0
-94	4,0

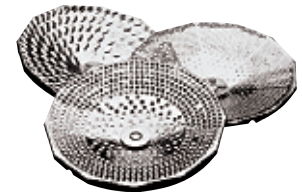

Griglie per art.
Discs for item
Roste für Art.-Nr.
Grilles pour réf. 42570 - 42573
Rejillas para art. 42570 - 42573

art.	mm.
-91	1,5
-92	2,5
-94	4,0





Apriscatole da banco, inox
Table top can opener, s/s
Tisch-Dosenöffner, Edelstahl Rostfrei
Ouvre-boîte, acier inox
Abrelatas, inox

N

art.	dim. cm.	kg	h. max.
49813-00	25x25x57	3,1	32

Formati scatola fino a ø 330 mm, altezza da 40 a 320 mm. - Can size up to ø 330mm, height from 40 to 320 mm.



Apriscatole da banco
Table top can opener
Tisch-Dosenöffner
Ouvre-boîte
Abrelatas

art.	l. cm.	h. max.
19810-00	56	45

Corpo in alluminio pressofuso, testa in acciaio, fissaggio a viti o morsetto. Clamp base and bar in cast iron, stainless steel head. Table fixing either with screws or clamp.



Apriscatole da banco, acciaio
Table top can opener, steel
Tisch-Dosenöffner, Edelstahl
Ouvre-boîte, acier
Abrelatas, acero

art.	l. cm.	h. max.
49811-00	40	30

Testa in materiale composito epossidico, fissaggio a morsetto, base 18x8 cm. Lama inox reversibile. Composite material head. Table fixing either with clamp, base 18x8 cm. Stainless steel reversible blade.



Apriscatole da banco, inox
Table top can opener, stainless steel
Tisch-Dosenöffner, Edelstahl Rostfrei
Ouvre-boîte, inox
Abrelatas, inox

art.	l. cm.	h. max.
49812-00	55	40

Fissaggio a morsetto, base 22x12 cm. Lama inox reversibile. - Table fixing with clamp, base 22x12 cm. Stainless steel reversible blade.



Apriscatole elettrico, inox
Electric can opener, stainless steel
Elektrodosenöffner, Edelstahl Rostfrei
Ouvre-boîte électrique, inox
Abrelatas eléctrico, inox

art.	dim. cm.	h.	kg.
49814-00	44x25	75	13

230V - 75W. Motore a 2 velocità. Per tutti i formati di scatola da 50 a 270 mm di altezza. - Dual speed motor. Opens all can shapes from 50 to 270 mm height.



Apriscatole da banco, inox
Table top can opener, stainless steel
Tisch-Dosenöffner, Edelstahl Rostfrei
Ouvre-boîte, inox
Abrelatas, inox

art.	l. cm.
49861-10	55

Lavabile in lavastoviglie, cambio rapido lama e sistema ingranaggi, modello con morsetto. Ideale per 15-20 lattine al giorno di h. 43 cm max. - Dishwasher safe, features quick change knife and gear system, clamp model. For uses up to 15-20 cans per day, max height 43 cm.



Apriscatole da banco
Table top can opener
Tisch-Dosenöffner
Ouvre-boîte
Abrelatas

art.	l. cm.	h. max.
49861-00	56	40

Corpo e asta in acciaio inox, testa in acciaio, fissaggio con morsetto. Clamp base and bar in stainless steel, cast iron head. Table fixing with clamp.



Apriscatole elettrico, inox
Electric can opener, stainless steel
Elektrodosenöffner, Edelstahl Rostfrei
Ouvre-boîte électrique, inox
Abrelatas eléctrico, inox

art.	dim. cm.	h.	kg.
49862-00	11x16	28	6,5

Motore a 2 velocità. Altezza max scatole 17 cm. - Dual speed heavy motor. Cans max height 17 cm.



Spazzola di pulizia
Cleaning brush
Reinigungsbürste
Brosse de nettoyage
Cepillo para limpieza

art.
49861-01

TERMOMETRI THERMOMETERS

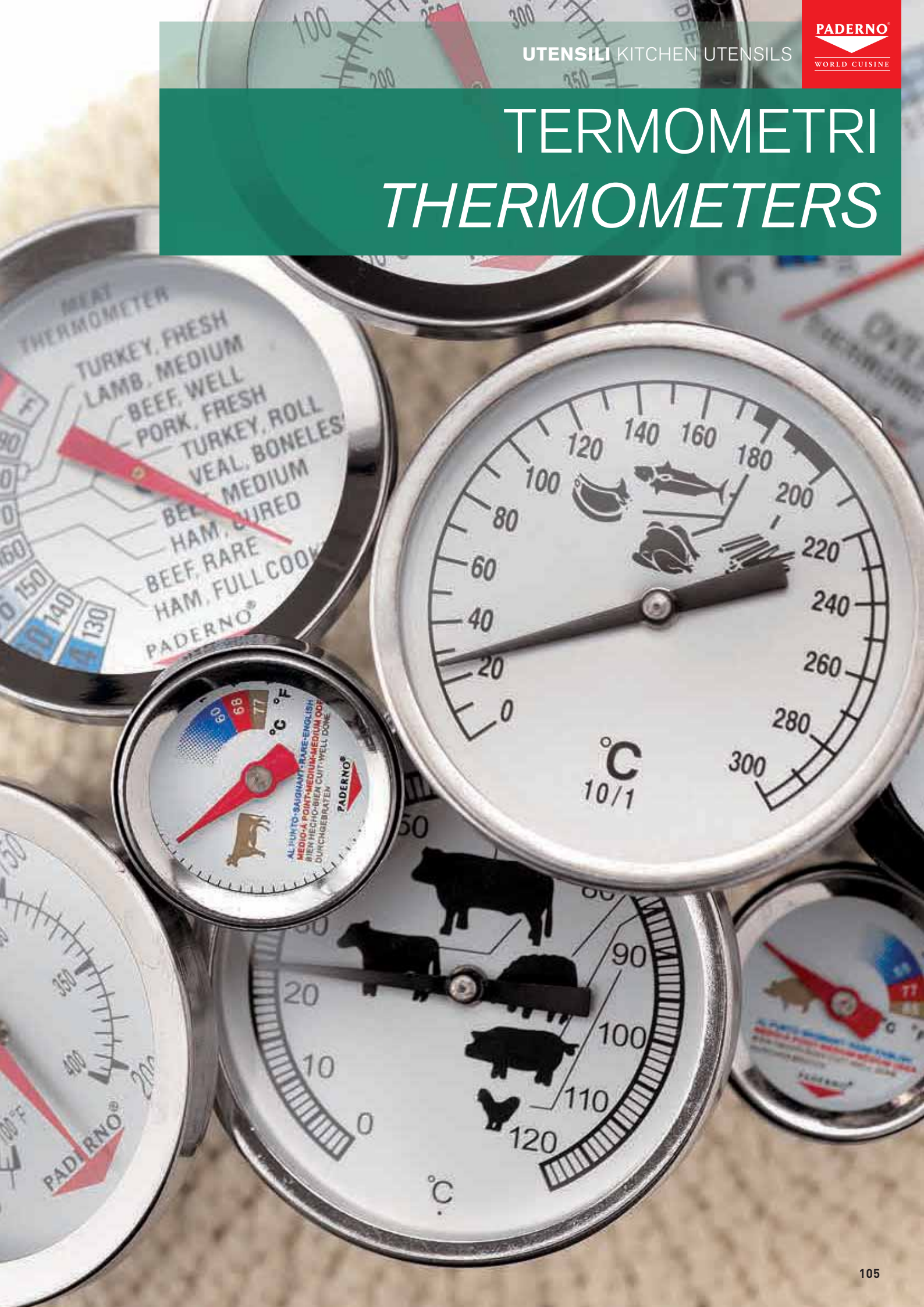

UTENSILI KITCHEN UTENSILS



P

Termometro arrosti
Meat roasting thermometer
Braten-Thermometer
Thermomètre à rôtir
Termómetro asado

art. ø cm. scala range
49705-00 4,5 1°C 0+120°C

Lunghezza sonda 13 cm.
Penetration probe 13 cm.



P

Termometro arrosti
Meat roasting thermometer
Braten-Thermometer
Thermomètre à rôtir
Termómetro asado

art. ø cm. scala range
19705-00 5 +54+88°C



P

Termometro fritti
Cooking & frying thermometer
Back-Thermometer
Thermomètre à friture
Termómetro frituras

art. ø cm. scala range
19706-00 5 10°C +38+205°C



Termometro per zucchero
Sugar thermometer
Zuckerthermometer
Thermomètre à sucre
Termómetro azúcar

art. l. cm. scala range
47843-00 30 1°C +80+200°C

Guaina inox. - Stainless steel housing.



Termometro per panettiere
Baker's thermometer
Bäckerthermometer
Thermomètre boulanger
Termómetro panadero

art. l. cm. scala range
49712-00 30 1°C -10+60°C

Guaina plastica. - Plastic housing.



P

Termometro per forno, inox
Oven thermometer, stainless steel
Ofenthermometer, 18-10 Edelstahl
Thermomètre à four, inox
Termómetro horno, inox

art. ø cm. scala range
19709-00 7 10°C +38+316°C



Termometro frigo/freezer, ABS
Fridge/freezer thermometer, ABS
Kühlschrankthermometer, ABS
Thermomètre à réfrigérateur, ABS
Termómetro congelador, ABS

art. ø cm. scala range
49885-02 7 1°C -50+50°C



P

Termometro frigo/freezer, inox
Fridge/freezer thermometer, s/s
Kühlschrankthermometer, Edelstahl
Thermomètre à réfrigérateur, inox
Termómetro congelador, inox

art. ø cm. scala range
19702-00 6 1°C -29+27°C



Termometro digitale, ABS
Digital thermometer, ABS
Digitalthermometer, ABS
Thermomètre digitale, ABS
Termómetro digital, ABS

art. dim. cm. scala range
49887-00 1,5x5x7 0,1°C -50+70°C



Termometro da muro
Room/wall thermometer
Wandthermometer
Thermomètre à mur
Termómetro de pared

art. dim. cm. scala range
49702-00 20,5x4 1°C -30+50°C



Termometro da tasca
Pocket thermometer
Taschenthermometer
Thermomètre à poche
Termómetro digital

art. l. cm. scala range
19701-00 15 0,1°C -50+150°C



Termometro digitale
Digital thermometer
Digitalthermometer
Thermomètre digitale
Termómetro digital

art. scala range
49710-00 1°C -50+300°C
Sonda/Probe: l. 135 mm - ø 2,5 mm.

**UTENSILI KITCHEN UTENSILS
TERMOMETRI THERMOMETERS**



Termometro da tasca
Pocket thermometer
Taschenthermometer
Thermomètre à poche
Termómetro digital

art. ø mm. scala range
49701-00 3,5 0,1°C -50+200°C

Lunghezza sonda 12,5 cm.
Penetration probe 12,5 cm.



Termometro digitale
Digital thermometer
Elektronisches Thermometer
Thermomètre digital
Termómetro digital

art. ø mm. scala range
49715-00 3,5 0,1°C -50+300°C

Lunghezza sonda 12,5 cm.
Penetration probe 12,5 cm.



Termometro digitale
Digital thermometer
Elektronisches Thermometer
Thermomètre digital
Termómetro digital

art. dim. cm. scala range gr.
49716-00 1,9x7x15,2 0,1°C -50+300°C 175

Countdown/up 99h-59m, volume regolabile a 92dB. In astuccio con sonda di penetrazione. Batteria AAA 2x1,5V, 5000 ore. - Countdown/up 99h 59m, adjustable volume to 92dB. Supplied in a wallet complete with penetration probe. Battery 2x1.5V AAA, life 5000 hours.



Termometro digitale
Digital thermometer
Digitalthermometer
Thermomètre digital
Termómetro digital

art. dim. cm. scala range
49883-00 13x5,5x2,5 0,1°C -50+300°C

Involucro ABS con additivi "Biomaster" che aiutano a ridurre la crescita batterica. Sonda da 13 cm ed 1 mt di cavo PU a spirale. - ABS case that contains "Biomaster", additive to reduce bacterial growth. Supplied with penetration probe with a 13 cm pointed s/s stem and 1 mt coiled PU lead.



Termometro multifunzione
Multi-function thermometer
Multifunktions-Thermometer
Thermomètre multifonction
Termómetro multifunción

art. dim. cm. scala range
49988-00 3,2x8,6x11,6 0,1°C -49,9+149,9°C

Sonda di penetrazione in acciaio inox (Ø 3.5 x 125 mm) con cavo PVC da 1mt e cappuccio sonda. - Supplied with a pointed, S/S, food penetration probe (Ø 3.5 x 125 mm) with a 1mt PVC connecting lead and probe cover.



Termometro a infrarossi
Infrared thermometer
Infrarot-Thermometer
Thermomètre infrarouge
Termómetro infrarrojo

art. dim. cm. scala range
49986-00 2,5x5,2x10 0,1°C -49,9+349,9°C

90 gr., batteria AAA 2x1,5V, 20 ore uso continuativo. - 90 grams, battery 2x1.5V AAA, life 20 hours continuous use.



Termometro a infrarossi
Infrared probe thermometer
Infrarot-Thermometer
Thermomètre infrarouge
Termómetro infrarojos

art. dim. cm. scala gr.
49884-08 4x6,6x15,5 0,1/1°C 185

Batteria alcalina 2xAAA, 180 ore uso continuativo. Battery 2xAAA alkaline, life 180h continuous use. Infrared range: -60 to 500°C Probe range: -64 to 1370°C



Termometro a infrarossi
Infrared thermometer
Infrarot-Thermometer
Thermomètre infrarouge
Termómetro infrarojos

art. dim. cm. scala range
49717-00 17,5x4x7,2 1°C -50+400°C



Termometro a infrarossi
Infrared thermometer
Infrarot-Thermometer
Thermomètre infrarouge
Termómetro infrarojos

art. dim. cm. scala range gr.
49987-00 3,6x8,8x13,1 0,1°C -50+330°C 143

Batteria 9 volt PP3, 80 ore uso continuativo. Allineamento laser incorporato. - Battery 9 volt PP3, life 80 hours continuous use. Incorporated laser assisted alignment.



Termometro digitale
Digital thermometer
Elektronisches Thermometer
Thermomètre digital
Termómetro digital



art.	dim. mm.	scala	range	col.	art.	dim. mm.	resol.	range	col.
49880-10	19x50x157	0,1 or 1°C	-49,9+299,9°C	●	49880-13	19x50x157	0,1 or 1°C	-49,9+299,9°C	●
49880-11	19x50x157	0,1 or 1°C	-49,9+299,9°C	●	49880-14	19x50x157	0,1 or 1°C	-49,9+299,9°C	●
49880-12	19x50x157	0,1 or 1°C	-49,9+299,9°C	●	49880-15	19x50x157	0,1 or 1°C	-49,9+299,9°C	○

Sonda di penetrazione a punta ridotta (Ø3,3 x 115 mm) in acciaio inox, pieghevole a 180°. Alimentato da una singola batteria AAA, visualizza sia l'avviso di batteria scarica (icona) sia l'indicazione di circuito aperto. Modalità riposo da 10 a 180 secondi - selezionabile dall'utente. Tipo di sensore K termocoppia. Dimensioni display 39 x 25 mm (dimensione del carattere 15x11 mm). Peso 120 grammi. Certificato di calibrazione tracciabile incluso. **Reduced tip, stainless steel, food penetration probe (Ø3.3 x 115 mm) that conveniently folds back through 180°. Powered by a single AAA battery, both low battery (icon) and open circuit indication are displayed, when applicable. Sleep mode 10 to 180 seconds - user selectable. Sensor type K thermocouple. Display size 39 x 25 mm (character size 15x11 mm). Weight 120 grams. FREE traceable certificate of calibration included.**



- 1 - SCOCCA.** Design più ergonomico. Additivo antibatterico biomaster nella scocca inibisce la crescita di batteri
CASE / HOUSING. Improved ergonomic design. Biomaster anti-bacterial additive in casing inhibits bacterial growth
- 2 - Migliore resistenza all'acqua - Improved water resistance**
- 3 - Coperchio scomparto batteria con chiusura a vite**
Battery cover includes a screw fitting
- 4 - Il rientro rende più agevole l'impugnatura**
Indentation makes it easier to grab
- 5 - MIGLIORE VISUALIZZAZIONE**
Un sensore di movimento preserva la durata della batteria quando non in uso. Si accende quando si apre la sonda. Nessun pulsante. Display automatico rotante a 360° brevettato, può essere utilizzato in qualsiasi posizione con entrambe le mani. Accuratezza ±0.4°C in soli 3 secondi
IMPROVED DISPLAY
Motion sensor saves battery life when put down, wakes up when picked up. Turns on when you open the probe. No buttons. Patented, automatic 360° rotating display can be used in any position in either hands. Accurate to ±0.4°C in just 3 seconds
- 6 - NUOVO SCOMPARTO BATTERIA**
Pulsante cambio °C o °F, 1° oppure 0.1°, rotazione display e modalità riposo. Batteria standard AAA. Durata fino a 3.000 ore
NEW BATTERY COMPARTMENT
Buttons change °C or °F, 1° or 0.1°, display rotation & sleep settings. Standard AAA battery. Battery life up to 3.000 hours
- 7 - Retroilluminazione con attivazione automatica in condizioni di poca luce.** Ora 30% più luminosa. Si accende sfiorando il sensore
Backlight automatically activates in low light conditions. Now 30% brighter. Turn on by touching the sensor window



Termometro per sottovuoto
Sous vide cooking thermometer
Vakuüm-Koch-Thermometer
Thermomètre pour cuisson sous-vide
Termómetro cocción al vacío

art.	dim. cm.	gr.
49881-01	2,5x5,6x12,8	130

Range 0,1°C (-99,9+299,9°C), range 1°C (300+372°C). Batteria AAA 3x1,5V, durata minima 5 anni (10.000 ore). Schermo LCD 12 mm. Risposta veloce, raggiunge la temperatura in soli 3 secondi. Ogni kit contiene 1 termometro, 1 sonda per sottovuoto 60 mm., 1 metro di nastro adesivo, astuccio con zip, certificato di calibrazione tracciabile. - Range 0.1°C (-99.9+299.9°C), range 1°C (300+372°C). Battery 3x1.5V AAA, life minimum 5 years (10000 hours). Display 12 mm LCD. Fast response, reaches temperature in just 3 seconds. Each kit contains 1 thermometer, 1 Sous Vide needle probe 60 mm., one metre foam/tape, zip pouch, FREE traceable certificate of calibration.





Spatola con termometro
Spatula with thermometer
Rührspaten mit Thermometer
Spatule avec thermomètre
Espátula con termómetro

art. dim. cm. range
49729-00 26x4x1,8 -50+300°C



N

Termometro digitale da forno
Digital Oven Thermometer
Ofen-Digitalthermometer
Thermomètre à four digital
Termómetro horno digital

art. ø cm. h. scala range gr.
49719-00 8 2 1°C/F -50+300°C 90

Scocca in ABS. Lettura in 5 secondi. Allarme acustico 70dB. Sonda di penetrazione da 114 mm con cavo in acciaio inox da 1,2 metri che permette l'utilizzo durante la cottura. Batteria: 2 x 1.5 volt AAA. Durata 5000 ore. Resistenza acqua/polvere. IP65. - ABS case. Temperature reading in 5 seconds. Loud 70dB audible temperature alarm. 114 mm penetration probe with a 1,2 metre stainless steel braided lead. Braided lead allows the probe to remain in the food during cooking. Battery: 2 x 1.5 volt AAA. Battery life: 5000 hours. Water/dust resistance: IP65 protection.



Timer/termometro da forno
Oven timer/cooking thermometer
Digitalkochalarm
Minuterie digitale
Reloj/termómetro digital

art. dim. cm. scala range
49718-00 13x7,5x2 1°C 0+300°C

Timer 23h 59min 59sec. Allarme acustico. Sonda ad alta temperatura e 2 m. di cavo. Penetrazione sonda 15 cm (ø4 mm). - Count down/up from/to 23h 59m 59 sec. With audible high alarm. Supplied with a high temperature probe and a 2 mt s/s braided lead. Probe insertion 15 cm.



N

Timer digitale a tenuta stagna
Waterproof digital timer
Wasserdichte Digitaltimer
Timer digital étanche
Reloj digital impermeable

art. ø mm. h.
49733-00 80 17

99M-99S : A prova di polvere e farina. Suono e allarme lampeggiante. Gancio e ventosa. - Dust and flour proof. Sound and flashing alarms. Hanging hook and suction cup.



Timer digitale, H/M/S
Digital timer
Digitalkochalarm
Minuterie digitale
Reloj digital

art. dim. cm.
49720-00 7x5,5

Timer 23H-59M-59S. Orologio 12H AM/PM. Cronometro. Allarme acustico 80dB. Attacco magnetico.
Timer 23H-59M-59S. Clock 12H AM/PM. Count down. 80dB audible alarm. Magnetic pad.



N

Timer digitale
Digital timer
Digitalkochalarm
Minuterie digitale
Reloj digital

art. dim. cm. h.
49734-00 9x4,7 4,5

Count-down/up: 23H 59M 59S
80 dB sound



N

Timer digitale gigante
Digital timer jumbo
Digitalkochalarm jumbo
Minuterie digitale géante
Reloj digital gigante

art. dim. cm. h.
49735-00 13,5x9,5 16

80 dB sound



Pesa sciropo (densimetro)
Syrup density meter
Sirup-Hydrometer
Pèse-sirop
Aerómetro

art.	l. cm.	g/ml/°Bé	°C
49703-00	12,5	1.100-1.400/15-40	20
div.: 0,010 g/ml/2°Bé.			

Per misurare il contenuto di sale di alimenti e liquidi in percentuale (da 0 a 5%). È inoltre in grado di misurare la temperatura (0-100°C). Utilizza due batterie a bottone CR2032. Fornito con cucchiaino dosatore e fiala contenente una concentrazione di cloruro di sodio al 2% per calibrare lo strumento.
To measure the salt content of foods and liquids in percentage (0 to 5%). Temperature 0-100°C. 2xCR2032 coin cell. Supplied with measuring spoon and vial containing sodium chloride, concentration 2% to calibrate the instrument.



Salinometro + termometro
Salt manager + thermometer
Salzgehalt-Meter + Thermometer
Testeur de salinite + thermomètre
Salinometro + termómetro

art.	dim. cm.	gr.
49730-00	3,2x1,6x22,5	54



Densimetro per salamoia e sale
Hydrometer for brine and salt
Hydrometer für Sole und Salz
Densimètre pour saumure et sel
Hidrómetro salmuera y sal

art.	l. cm.	g/ml/°Bé	°C
49730-20	19,5	1.000-1.250/0-30	20
div.: 0,001 g/ml/2°Bé.			



Tester per oli di frittura
Cooking oils tester
Kontrollsystem für Bratenöle
Test des huiles
Controlador de aceite de frituras

art.	dim. cm.	h.
49731-00	24x21	6,5

Sistema per l'autocontrollo dello stato di degradazione degli oli di frittura, attraverso metodo colorimetrico, basato sulla verifica della percentuale dei composti polari. Il kit è sufficiente per effettuare circa 30 controlli. Tempo di risposta 3 minuti circa. Kit fornito in comoda valigetta con foglio istruzioni.
Self-test system for evaluating the degree of deterioration of heated oils and grases by a colorimetric method based on the percentage of ionic compounds. Around 30 applications per kit. Response time about 3 minutes. Each kit is supplied with carrying case and instructions.



ORION Orologio da parete
Wall clock
Wanduhr
Horloge à paroi
Reloj de pared

art.	ø cm.
41380-01	29

Metallo satinato, pila alcalina inclusa. - Satin alloy, battery included.



SILENT Orologio da parete
Wall clock
Wanduhr
Horloge à paroi
Reloj de pared

art.	ø cm.
41380-02	30,5

ABS, pila alcalina inclusa. Movimento silenzioso.
ABS, battery included. Silent clock.

BILANCE - SCALES



Bilancia digitale
Digital scale
Präzisionswaage
Balance digitale
Balanza digital



art.	dim. cm.	scala	kg.
49865-06	21,6x17,1x6,3	1g	6

Protezione antimicrobica. Conteggio porzioni. Ampia piattaforma cm 4,6x16,5. Schermo angolare LCD. Adattatore AC o batterie. Costruzione in ABS/acciaio inox. - Antimicrobial protection. Portion count. Large and removable platform cm 14,6x16,5. AC adapter or batteries supply. ABS/stainless steel construction.

Bilancia digitale
Digital scale
Präzisionswaage
Balance digitale
Balanza digital



art.	dim. cm.	scala	kg.
49865-70	30,5x31,8x5,7	100g	68

Piattaforma cm 30,5x30,5. Indicatore batteria scarica. Supporto schermo LCD da 2,5 cm rimovibile per montaggio a parete. Piedini antiscivolo. Alimentazione a corrente o a batteria. - Platform cm 30,5x30,5. Low battery indicator. Remote LCD wall mount display. Non-slip feet. Electric or batteries supply.

Bilancia meccanica, inox
Mechanical scale, stainless steel
Waage, Edelstahl Rostfrei
Balance, inox
Balanza, inox

art.	ø cm.	scala	kg.
49864-03	20	10g	3
49864-05	20	20g	5



Bilancia meccanica, inox
Mechanical scale, stainless steel
Waage, Edelstahl Rostfrei
Balance, inox
Balanza mecánica, inox

art.	ø cm.	scala	kg.
49864-20	25	100g	20



Edlund

Bilancia meccanica, inox
Mechanical scale, stainless steel
Automatische Waage, Edelstahl Rostfrei
Balance automatique, inox
Balanza mecánica, inox

art.	dim. cm.	scala	kg.
49866-01	18x22	5g	1
49866-02	18x22	10g	2
49866-05	18x22	20g	5



Edlund

Bilancia digitale
Digital scale
Präzisionswaage
Balance digitale
Balanza digital

art.	dim. cm.	scala	kg.
49863-10	24x18	1,0g	10

3 batterie tipo R14 1,5V (non incluse).
Alimentatore tipo DC 6V 300mA a richiesta. - 3 batteries type R14 1,5V (not included). Adapter DC 6V 300mA upon request.



Bilancia digitale
Digital scale
Präzisionswaage
Balance digitale
Balanza digital

art.	ø cm.	scala	kg.
49853-01	13	0,5g	1
49853-03	13	1,0g	3

2 batterie tipo AA (non incl.).
2 batteries type AA (not included).



Bilancia digitale
Digital scale
Präzisionswaage
Balance digitale
Balanza digital

art.	dim. cm.	scala	kg.
49863-30	23,5x30	2g	30
49863-50	23,5x30	5g	50



Bilancia digitale
Digital scale
Präzisionswaage
Balance digitale
Balanza digital

art.	dim. cm.	scala	kg.
49863-15	23x29,5x12,5	2g	15

4 batterie tipo LR20 1,5V (non incl.).
4 batteries type LR20 1,5V (not included).



Bilancia da tasca
Pocket scale
Taschenwaage
Balance de poche
Balanza de bolsillo

art.	dim. cm.	scala	g.
49852-20	10,6x6,4x4	0,01g	200

Funziona con 2 pile tipo AAA. - Powered by 2 batteries type AAA.



Bilancia digitale
Digital scale
Präzisionswaage
Balance digitale
Balanza digital

art.	dim. cm.	scala	kg.
49863-95	57x32x61	20g	150
49863-99	67,5x42x88	50g	300

IP 51. Funziona con una batteria ricaricabile 6V.
Powered by 6V rechargeable battery.



SERIE 48280 - 48278



Un'ampia gamma di utensili professionali per la cucina, indispensabili per creare decorazioni originali e fantasiose, ma utili anche per svolgere le più semplici operazioni in modo preciso e veloce. Tutti i pezzi sono realizzati in acciaio inox 18/10, mentre la maniacatura ergonomica è prevista nella versione acciaio inox o polipropilene. Tutti gli articoli sono dotati di un foro sul manico per essere appesi. Lavabili in lavastoviglie. Il design è moderno e funzionale per il massimo comfort d'utilizzo.

A wide range of professional kitchen utensils. These are essential tools to make original decorations as well as to ease the preparation of your recipes. All items are made of 18/10 stainless steel while their ergonomic handles are available both in stainless steel and Polypropylene. They are all hangable and can be cleaned in dishwasher. They boast a modern, functional design and are very easy to use.



Coltello per pizza
Pizza knife
Pizza-Messer
Couteau à pizza
Cuchillo pizza

art.	l. cm.
48280-45	23,5



Rotella taglia pizza
Pizza wheel
Pizza-Rad
Roulette à pizza
Ruleta cortapizzas

art.	l. cm.	Ø
18324-10	24	10



Rotella taglia pasta
Pastry wheel
Teig-Rad
Roulette à pâte
Ruleta cortapasta

art.	l. cm.	Ø
48280-32	18	4
48280-39	18	4



Coltello verdure
Vegetables knife
Gemüsemesser
Couteau à crudités
Cuchillo verduras

art.	l. cm.
48280-48	19



Coltello pomodori/limoni
Tomato/lemon knife
Tomaten-/Zitronenmesser
Couteau à tomates/citrons
Cuchillo tomate/limón

art.	l. cm.
48280-58	23,5



Falcetta prezzemolo
Parsley knife
Petersilie-/Wiegemesser
Hachinette persil
Cuchillo perejil

art.	l. cm.	Ø
48280-20	17	10,5

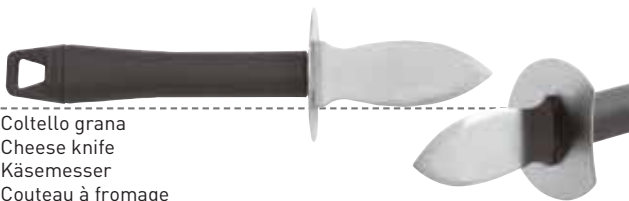

Coltello grana
Cheese knife
Käsemesser
Couteau à fromage
Cuchillo queso

art.	l. cm.
48280-04	20

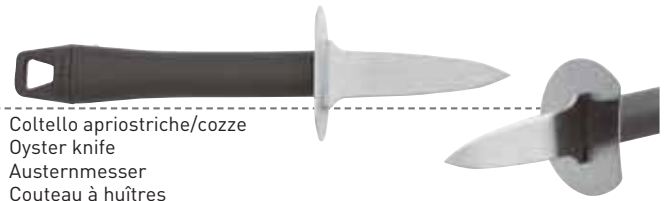

Coltello apriostriche/cozze
Oyster knife
Austernmesser
Couteau à huîtres
Cuchillo ostras

art.	l. cm.
48280-05	20,5



Coltello castagne
Chestnut knife
Kastanienmesser
Couteau à marrons
Cuchillo castañas

art.	l. cm.
48280-21	16



Squamapesce
Fish scaler
Fischentschupper
Ecailleur à poisson
Escamador

art.	l. cm.
48280-38	23,5



Squamapesce doppio
Double fish scaler
Fischentschupper, doppel
Ecaillieur à poisson double
Escamador doble

art. dim. cm.
48280-37 22,5x3,5

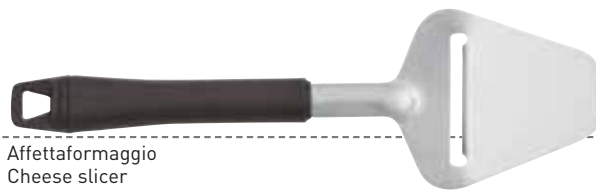

Affettaformaggio
Cheese slicer
Käsemesser
Couteau à fromage
Cuchillo para cortar queso

art. dim. cm.
48280-41 25x7,6



Affettaformaggio tenero
Cheese slicer
Käsemesser
Couteau à fromage
Cuchillo para queso suave

art. l. cm.
48280-42 20,5



Mannaietta per formaggio
Cheese cleaver
Käsemesser
Couteau à fromage
Hacha para queso

art. dim. cm.
48280-49 21x4



Cottello formaggi duri
Cheese knife
Käsemesser
Couteau à fromage
Cuchillo para queso duro

art. l. cm.
48280-56 23,5



Cottello formaggio
Cheese knife
Käsemesser
Couteau à fromage
Cuchillo para queso

art. l. cm.
48280-59 27



Cottello formaggi duri
Parmesan knife
Käsemesser
Couteau à fromage
Cuchillo para queso parmesano

art. l. cm.
48280-46 24



Spalmaburro
Butter spreader
Butterstreicher
Couteau à tartiner
Cuchillo para untar

art. l. cm.
48280-75 21,5



Cottello tortiera
Pie pan knife
Tortenring-Messer
Couteau à manqué
Cuchillo para tartas

art. l. cm.
48280-22 21



Temperino per verdure
Vegetable sharpener
Gemüsefedermesser
Taille crayon légumes
Afilador para vegetales

art. ø cm.
48280-12 4,5
48280-13 7,0



Pennello
Pastry brush
Kuchenpinsel
Pinceau
Pincel pastelería

art. dim. cm.
48280-09 25,5x4



Pennello
Pastry brush
Kuchenpinsel
Pinceau
Pincel pastelería

art. dim. cm.
48280-94 22,5x3,5



Grattugia formaggio
Ceddar/cheese grater
Käseraffel
Râpe à fromage
Rallador queso

art. l. cm.
48280-06 24



Grattugia agrumi
Citrus fruit grater
Zitrusraffel
Râpe à agrumes
Rallador cítricos

art. l. cm.
48280-07 24



Apribottiglie
Bottle opener
Flaschenöffner
Décapsuleur
Abrebotellas

art. l. cm.
48280-02 19



Apriscatole
Can opener
Dosenöffner
Ouvre boîtes
Abrelatas

art. dim. cm.
48280-03 22x4,6



Scavino
Melon baller
Kugelausstecher
Cuillère parisienne
Cortador bolas

art.	l. cm.	Ø
48280-24	19,0	1,0
48280-30	19,0	1,5
48280-31	19,0	2,0
48280-35	19,5	2,3
48280-36	19,5	3,0



Scavino doppio
Double melon baller
Kugelausstecher, doppel
Cuillère parisienne double
Cortador bolas doble

art. Ø mm.
48286-59 22-25



Scavino ovale
Oval melon baller
Kugelausstecher, oval
Moule à pommes, ovale
Cortador oval

art. l. cm. Ø
48280-26 19,5 1,9



Scavino ovale festonato
Oval melon baller, fluted
Kugelausstecher, oval, gerippt
Moule à pommes, ovale, cannelée
Cortador ovalado

art. l. cm.
48280-27 20

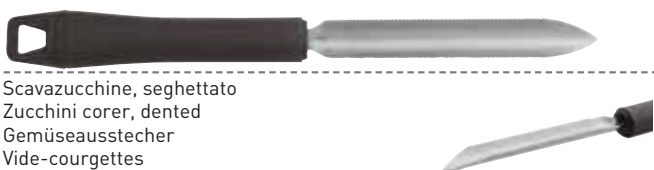

Scavazucchine, seghettato
Zucchini corer, dented
Gemüseausstecher
Vide-courgettes
Vaciador de zucchini

art. l. cm.
48280-54 24,5



Svuota ananas
Pineapple coring tool
Ananasausstecher
Vide ananas
Vacía corazón piña

art. l. cm.
48280-10 25



Pelasparagi
Asparagus peeler
Spargelschäler
Eplucheur à asperges
Pelador de espárrago

art. l. cm.
48280-85 23,5



Pelapomodori
Tomato peeler
Tomatenschäler
Eplucheur à tomates
Pelador de tomates

art. l. cm.
48280-08 18

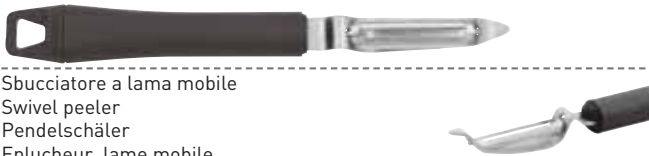

Sbucciatore a lama mobile
Swivel peeler
Pendelschäler
Eplucheur, lame mobile
Pelador con cuchilla mobil

art. l. cm.
48280-52 21

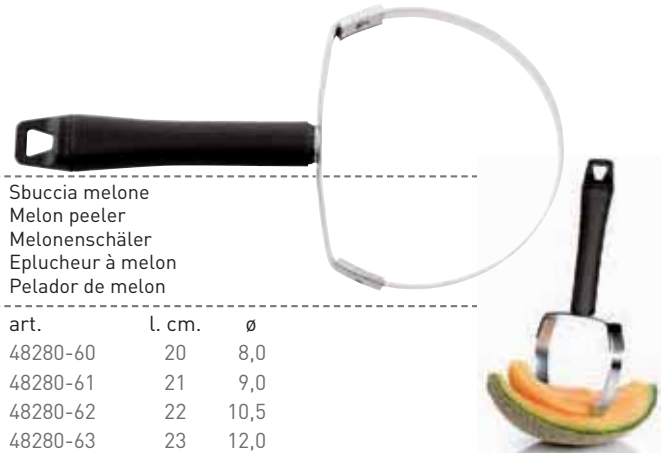

Sbuccia melone
Melon peeler
Melonenschäler
Eplucheur à melon
Pelador de melon

art.	l. cm.	Ø
48280-60	20	8,0
48280-61	21	9,0
48280-62	22	10,5
48280-63	23	12,0



Pelapatate
Potato peeler
Sparschäler
Eplucheur
Pelador de patatas

art. l. cm.
48280-34 19,5



Sbucciatore a Y
Y-shaped swivel peeler
Pendelschäler
Eplucheur
Pelador forma Y

art. l. cm.
48280-53 18,5

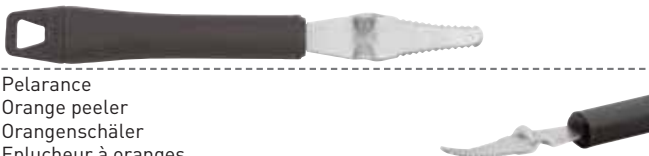

Pelarance
Orange peeler
Orangenschäler
Eplucheur à oranges
Pelador de naranjas

art. l. cm.
48280-96 20



Cottello per pompelmo
Grapefruit knife
Grapefruitmesser
Couteau à pamplemousse
Cuchillo para pomelo

art. l. cm.
48280-47 21,5



Porzionatore macedonia
Fruit scoop
Fruchtportionierer
Cuiller à fruits
Raciondor de ensalada de frutas

art. l. cm.
48280-15 20



Cottello agrumi
Citrus knife
Zitrus-Messer
Couteau à agrumes
Cuchillo para cítricos

art. l. cm.
48280-97 23

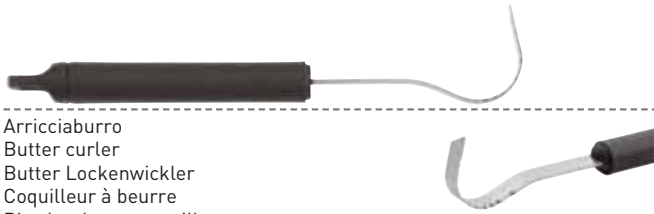

Arricciaburro
Butter curler
Butter Lockenwickler
Coquilleur à beurre
Rizador de mantequilla

art. l. cm.
48280-11 22,5

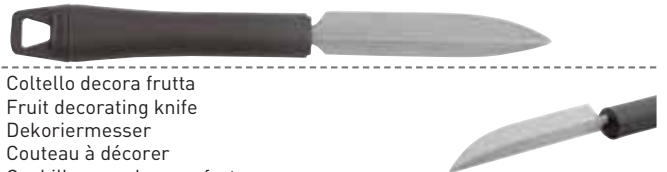

Coltello decora frutta
Fruit decorating knife
Dekoriermesser
Couteau à décorer
Cuchillo para decorar fruta

art. l. cm.
48280-91 23



Decoratore
Decorator
Ziseliermesser
Canneleur
Decorador

art. l. cm.
48280-95 16,5



Decoratore per mancini
Decorator, left handed
Ziseliermesser für Linkshänder
Canneleur gaucher
Decorador para zurdos

art. l. cm.
48280-93 16,5



Rigalimoni
Lemon striper
Zesteur
Canneleur
Acanalar de limones

art. l. cm.
48280-90 17



Decora limoni
Lemon striper
Zesteur
Canneleur
Decorador de limones

art. l. cm.
48280-92 17



Levatorsoli
Apple corer
Entkerner
Vide-pommes
Descorazonador

art. l. cm. ø
48280-25 21 1,2



Tagliaverdure ondulato
Vegetable cutter
Wellenschneider
Découpoir à lame ondulée
Cortador de verduras ondulado

art. l. cm.
48280-23 11,5



Taglia juliennes
Julienne cutting knife
Julienneschneidmesser
Couteau à juliennes
Cuchillo para juliennes

art. l. cm.
48286-61 18,5





Frusta
Whisk
Rührbesen
Fouet
Batidorr

art. l. cm. ø
48278-24 26,5 5



Colino conico
Conical colander
Suppensieb
Passe-bouillon
Colador cónico

art. l. cm. ø
48278-13 35 16

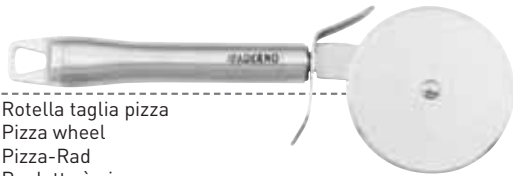

Rotella taglia pizza
Pizza wheel
Pizza-Rad
Roulette à pizza
Ruleta cortapizzas

art. l. cm. ø
48278-33 21 7



Rotella taglia pasta
Pastry wheel
Teig-Rad
Roulette à pâte
Ruleta cortapasta

art. l. cm. ø
48278-32 18 4



Rotella taglia pasta doppia
Double pastry wheel
Teig-Rad, doppel
Roulette a pâte double
Ruleta cortapasta doble

art. l. cm. ø
48278-39 18 4



Affettaformaggio a filo
Wire cheese slicer
Käse-Drahtschneider
Coupe fromage à fil
Cortador de queso a hilo

art. l. cm.
48278-43 25



Affettaformaggio tenero
Cheese slicer
Käsemesser
Couteau à fromage
Cortador de queso suave

art. dim. cm.
48278-42 20x7,5



Cottello verdure
Vegetables knife
Gemüsemesser
Couteau à crudités
Cuchillo de verduras

art. l. cm.
48278-48 19



Squamapesce
Fish scaler
Fischentschupper
Ecailleur à poisson
Escamador

art. l. cm.
48278-38 22



Mannaietta per formaggio
Cheese cleaver
Käsemesser
Coutau à fromage
Hachita para queso

art. dim. cm.
48278-49 21x4



Spelucchino
Paring knife
Spickmesser
Couteau d'office
Cuchillo moldeador

art. l. cm.
48278-55 22,5



Cottello parmigiano
Cheese knife
Käsemesser
Coutau à fromage
Cuchillo para queso

art. l. cm.
48278-46 23,5



Affettaformaggio
Cheese slicer
Käseraffel
Couteau à fromage
Cortador de queso

art. l. cm.
48278-41 25



Coltello apriostriche/grana
Oyster/cheese knife
Austern-/Käsemesser
Couteau à huîtres/fromage
Cuchillo para ostras/queso

art. l. cm.
48278-45 20

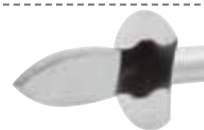

Pressapatate
Potato masher
Kartoffelpresse
Presse-purée
Prensador de patatas

art. l. cm. dim.
48278-87 27 8x7

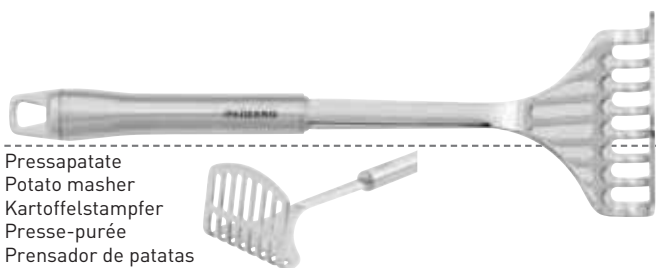

Pressapatate
Potato masher
Kartoffelstampfer
Presse-purée
Prensador de patatas

art. dim. cm.
48278-31 27x8



Spatola per glassa
Spatula
Palette
Spatule
Espátula

art. l. cm.
48278-77 27,5



Spalmaburro
Butter spreader
Buttermesser
Couteau à beurre
Cuchillo mantequilla

art. l. cm.
48278-75 21



Pennello pasticceria
Pastry brush
Kuchpinsel
Pinceau à cuisine
Pincel pastelería

art. l. cm.
48278-94 22

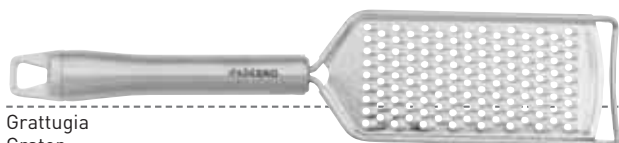

Grattugia
Grater
Raffel
Râpe
Rallador

art. dim. cm.
48278-20 25,5x5,5

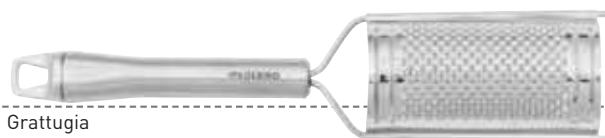

Grattugia
Grater
Raffel
Râpe
Rallador

art. dim. cm.
48278-21 25,5x5,5



Spremiaglio
Garlic press
Knoblauchpresse
Presse-ail
Prensador de ajo

art. dim. cm.
48278-37 19x5

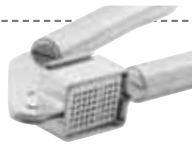

Apribottiglie
Bottle opener
Flaschenöffner
Ouvre-bouteilles
Abrebotellas

art. dim. cm.
48278-02 19x3,7

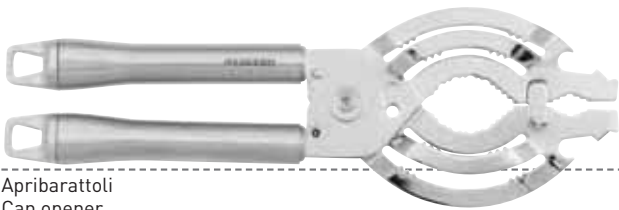

Apribarattoli
Can opener
Deckelöffner
Ouvre-boîtes
Abrelatas

art. dim. cm.
48278-01 25,5x8,5



Apriscatole
Can opener
Dosenöffner
Ouvre-boîtes
Abrelatas

art. dim. cm.
48278-03 22x4,6



Scavazucchine, seghettato
Zucchini corer, dented
Gemüseausstecher
Vide-courgettes
Vaciador de zucchini, dentado

art. l. cm.
48278-54 25



Pelapatate
Potato peeler
Kartoffelschäler
Eplucheur
Pelador de patatas

art. l. cm.
48278-34 19,5



Sbuciatore a lama mobile
Swivel peeler
Pendelschäler
Eplucheur
Pelador a cuchilla mobile

art. l. cm.
48278-52 21



Scavino sferico
Melon baller
Kugelausstecher
Moule à pommes
Vaciador

art. l. cm. ø
48278-35 18 3

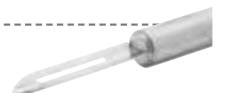

Sbuciatore a Y
Y-shaped swivel peeler
Pendelschäler
Eplucheur
Pelador forma Y

art. l. cm.
48278-53 18,5



Pelarance
Orange peeler
Orangenschäler
Eplucheur à pamplemousse
Pelador de naranja

art. l. cm.
48278-96 20



Levatorisoli
Apple corer
Entkerner
Vide-pomme
Descorazonador

art. l. cm. ø
48278-25 21,5 1,6



Cottello per pompelmo
Grapefruit knife
Orangenschäler
Couteau à pamplemousse
Cuchillo para pomelo

art. l. cm.
48278-47 21,5





Forchettina 3 punte
Potato fork
Gabelchän
Petite fourchette
Tenedor tre puntas

art.	l. cm.
48278-17	16,5



Porzionatore gelato
Ice cream scoop
Eisportionierer
Cuillère à glace
Racionador de helado

art.	l. cm.	ø
48278-95	21	4



Dosa caffè
Coffee measuring spoon
Maßlöffel
Cuillère à mesure
Porcionador de café

art.	l. cm.	ø
48278-16	20	3,5



Separauova
Egg separator
Eier-Trenner
Sépare oeufs
Separador de huevos

art.	l. cm.	ø
48278-36	20,5	5,5



Coltello decora frutta
Decorating knife
Dekoriermesser
Couteau à décorer
Cuchillo para decorar frutas

art.	l. cm.
48278-91	22,5



Cucchiaio cocktail
Cocktail spoon
Cocktailöffel
Cuiller à cocktail
Cuchara cóctel

art.	l. cm.	ø
48278-15	28	6

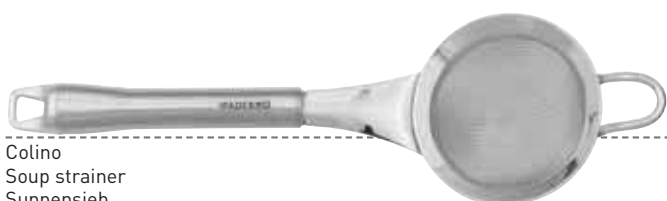

Colino
Soup strainer
Suppensieb
Passe-bouillon
Colador

art.	l. cm.	ø
48278-12	27	8



Decora limoni
Lemon striper
Zesteur
Canneleur
Decorador de limones

art.	l. cm.
48278-92	16,5



Arricciaburro
Butter curler
Buttermesser
Couteau à beurre
Ruzador de mantequilla

art.	l. cm.
48278-11	21,5



Saponetta toglì odori
Smell-remover soap
Geruchentferner-Seife
Savonette enlève odeurs
Jabon quita odores

art.	dim. cm.
48278-99	7,5x5,5



Mestolino salsa
Sauce ladle
Saucenlöffel
Louche à sauce
Cacillo salsa

art.	l. cm.	ø
48278-68	29	7

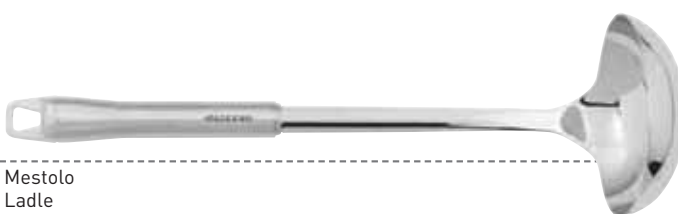

Mestolo
Ladle
Schöpflöffel
Louche
Cazo

art.	l. cm.	ø
48278-69	32	9



Mestolino
Small ladle
Schöpflöffel, klein
Petite louche
Cacillo

art. l. cm. ø
48278-66 29 6



Forchetta insalata
Salad fork
Saltgabel
Fourchette à salade
Tenedor para ensaladas

art. l. cm. ø
48278-64 25,5 5



Cucchiaio insalata
Salad spoon
Salatlöffel
Cuiller à salade
Cuchara para ensaladas

art. l. cm. ø
48278-62 25 5

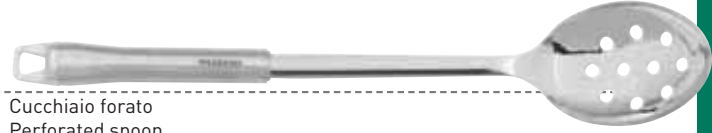

Cucchiaio forato
Perforated spoon
Giesslöffel, perforiert
Cuiller perforé
Cuchara perforada

art. dim. cm.
48278-61 34x6

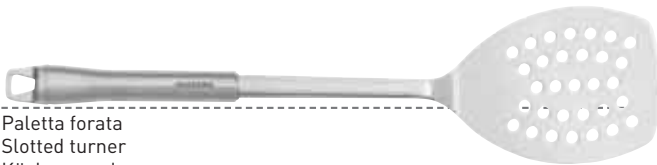

Paletta forata
Slotted turner
Küchenwender
Pelle ajourée
Espátula perforada

art. dim. cm.
48278-71 34,5x8,5

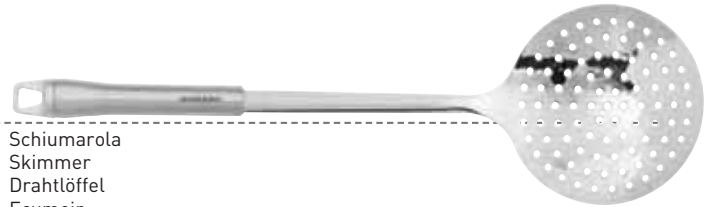

Schiumarola
Skimmer
Drahtlöffel
Ecumoir
Espumadera

art. l. cm. ø
48278-73 37 11

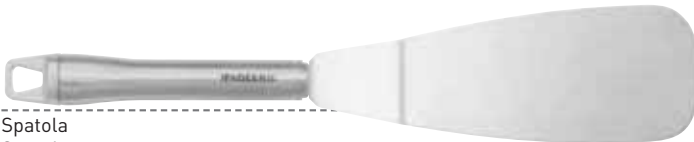

Spatola
Spatula
Palette
Spátule
Espátula

art. dim. cm.
48278-76 28,5x5,6



Pala torta
Pie server
Tortenheber
Pelle à gâteau
Paleta para tartas

art. dim. cm.
48278-93 26x5,8

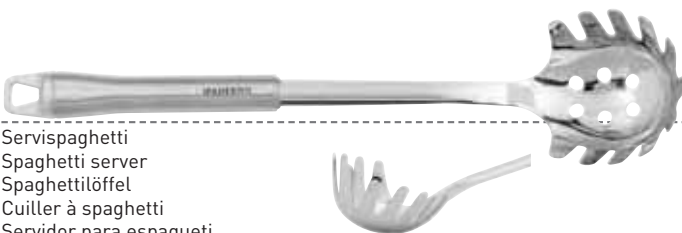

Servispaghetti
Spaghetti server
Spaghettilöffel
Cuiller à spaghetti
Servidor para espagueti

art. l. cm. ø
48278-74 30,5 7

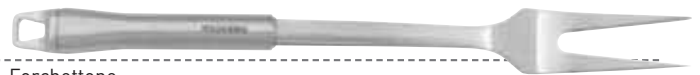

Forchettone
Fork
Gabel
Fourchette
Tenedor

art. l. cm.
48278-65 32,5

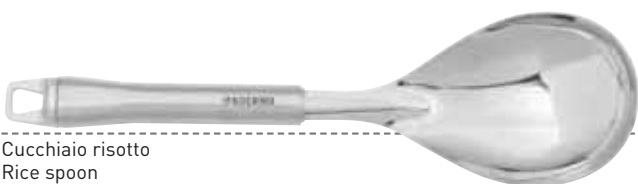

Cucchiaio risotto
Rice spoon
Reislöffel
Rice spoon
Cuchara para risotto

art. l. cm.
48278-63 27



Pala pasticcio
Lasagne spatula
Palette
Pelle
Pala para pastel

art. dim. cm.
48278-27 29x4,5

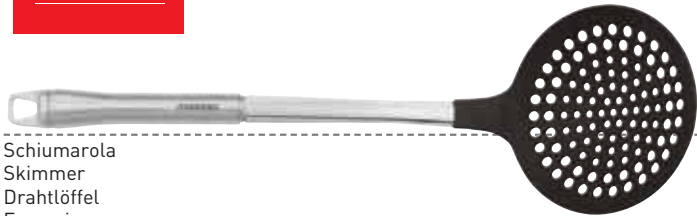

Schiumarola
Skimmer
Drahtlöffel
Ecumoir
Espumadera

art. l. cm. ø
48278-88 36,5 11

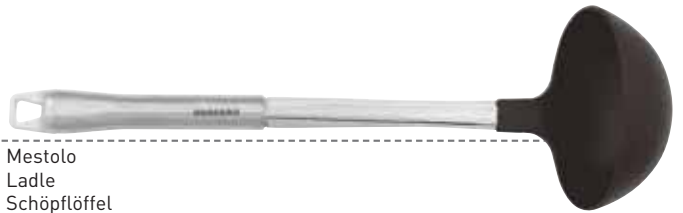

Mestolo
Ladle
Schöpflöffel
Louche
Cazo

art. l. cm. ø
48278-84 32,5 9,5



Cucchiaio riso
Rice spoon
Giesslöffel
Cuiller
Cuchara

art. dim. cm.
48278-82 33x6,5

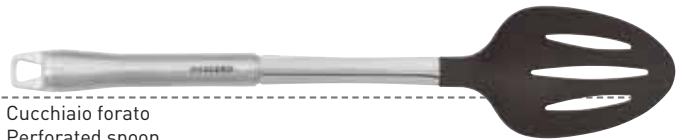

Cucchiaio forato
Perforated spoon
Giesslöffel, perforiert
Cuiller ajouré
Cuchara perforada

art. dim. cm.
48278-81 33x6,5



Servispaghetti
Spaghetti server
Spaghettillöffel
Cuiller à spaghetti
Servidor para espagueti

art. dim. cm.
48278-89 32x6,5



Forchettone
Meat fork
Gabel
Fourchette
Tenedor

art. l. cm.
48278-83 32,5



Cucchiaio silicone
Silicone spoon
Löffel aus Silikon
Cuiller en silicone
Cucharón de silicona

art. l. cm. dim.
48278-14 26,5 5,5x8

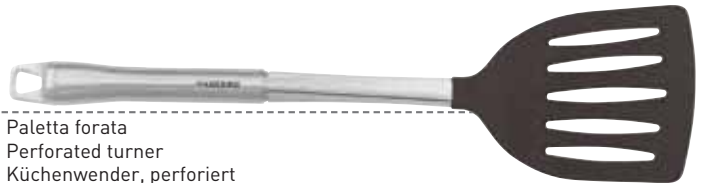

Paletta forata
Perforated turner
Küchenwender, perforiert
Pelle ajourée
Pala perforada

art. dim. cm.
48278-85 33x8,5

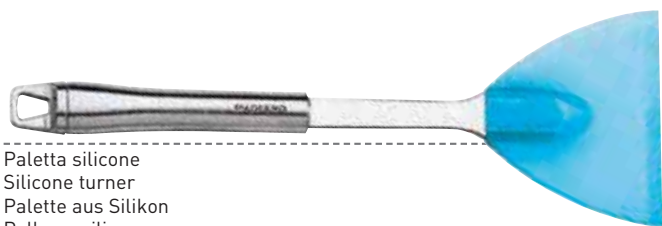

Paletta silicone
Silicone turner
Palette aus Silikon
Pelle en silicone
Paleta de silicona

art. l. cm. dim.
48278-30 27,5 9x7

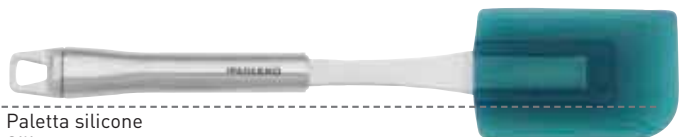

Paletta silicone
Silicone turner
Palette aus Silikon
Pelle en silicone
Paleta de silicona

art. l. cm. dim.
48278-29 25,5 3,5x5,5
48278-28 28,5 5x9



Frusta per uova
Egg whisk
Rührbesen
Fouet
Batidor

art. l. cm.
48278-18 24,5

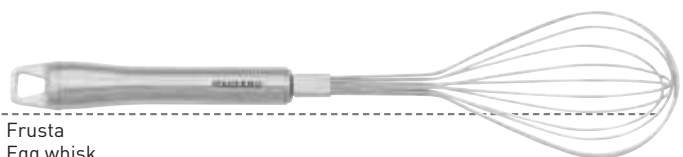

Frusta
Egg whisk
Rührbesen
Fouet
Batidor

art. l. cm.
48278-19 29,5

CUCINA ETNICA *ETHNIC CUISINE*



Tutte le foto degli articoli presenti nel capitolo rispecchiano il più possibile le caratteristiche dei prodotti presenti in magazzino. Teniamo comunque a precisare che le immagini sono indicative ed i prodotti reali potrebbero differire nei colori e nelle dimensioni. Le variazioni sono in ogni caso migliorative e tali da non alterare la natura e la funzionalità del prodotto stesso.

The images of the products in this chapter reflect the characteristics of the products in the warehouse. However, they have to be considered mainly for illustrative purposes only. Although we make every effort to display the products accurately, the products received may vary slightly from those images. In any case the changes are intended as improvements and do not alter the function, nor lessen the utility of the product.

ZEN



Una serie di ciotole dal chiaro design orientaleggiate create per servire dalla colazione alla cena. Una varietà di gusci funzionali e versatili, perfetti per presentare i più diversi alimenti alla moda, monoporzioni, fingerfood e specialità asiatiche, in puro gusto estetico.

A series of bowls in clear oriental design perfect for serving from breakfast through dinner. A variety of functional and versatile items which enable to serve any types of cuisine and can be mixed with plain white items of other shapes. Any fashion food served in a simple and pure aesthetic style.



Ciotola, melamina
Bowl, melamine
Schüssel, Melamin
Bol, melamine
Bol, melamine

Ciotola, melamina
Bowl, melamine
Schüssel, Melamin
Bol, melamine
Bol, melamine

Ciotola, melamina
Bowl, melamine
Schüssel, Melamin
Bol, melamine
Bol, melamine

art.	dim. cm.	h.	col.
44450-21	21x21	11	○
44450B21	21x21	11	●

art.	dim. cm.	h.	col.
44450-12	12x12	4	○
44450B12	12x12	4	●

art.	dim. cm.	h.	col.
44450-17	17,5x17,5	7	○
44450B17	17,5x17,5	7	●



Ciotola, melamina
Bowl, melamine
Schüssel, Melamin
Bol, melamine
Bol, melamine

Ciotola, melamina
Bowl, melamine
Schüssel, Melamin
Bol, melamine
Bol, melamine

Ciotola, melamina
Bowl, melamine
Schüssel, Melamin
Bol, melamine
Bol, melamine

art.	dim. cm.	h.	col.
44450-11	11x10	3	○
44450B11	11x10	3	●

art.	dim. cm.	h.	col.
44450-13	13x11	3,5	○
44450B13	13x11	3,5	●

art.	dim. cm.	h.	col.
44450-15	17,5x15,5	5,5	○
44450B15	17,5x15,5	5,5	●



Piatto, melamina
Dish, melamine
Platte, Melamin
Plat, melamine
Bandeja, melamine

Vassoio, melamina
Tray, melamine
Tablett, Melamin
Plateau, melamine
Bandeja, melamine

Vassoio, melamina
Tray, melamine
Tablett, Melamin
Plateau, melamine
Bandeja, melamine

art.	dim. cm.	h.	col.
44450-23	22x23,5	5,5	○
44450B23	22x23,5	5,5	●

art.	dim. cm.	h.	col.
44451-23	22,5x9,5	3	○
44451B23	22,5x9,5	3	●

art.	dim. cm.	h.	col.
44451-22	22x12	3	○
44451B22	22x12	3	●



Ciotola, melamina
Bowl, melamine
Schüssel, Melamin
Bol, melamine
Bol, melamine

art.	ø cm.	h.	col.
44452-31	31	8,5	○
44452B31	31	8,5	●



Ciotola, melamina
Bowl, melamine
Schüssel, Melamin
Bol, melamine
Bol, melamine

art.	dim. cm.	h.	col.
44453-14	14,5x12	5,5	○
44453B14	14,5x12	5,5	●



Ciotola, melamina
Bowl, melamine
Schüssel, Melamin
Bol, melamine
Bol, melamine

art.	ø cm.	h.	col.
44454-11	11,5	4	○
44454B11	11,5	4	●



Ciotola, melamina
Bowl, melamine
Schüssel, Melamin
Bol, melamine
Bol, melamine

art.	dim. cm.	h.	col.
44455-09	9x7	2,5	○
44455B09	9x7	2,5	●



Ciotola, melamina
Bowl, melamine
Schüssel, Melamin
Bol, melamine
Bol, melamine

art.	dim. cm.	h.	col.
44456-14	14x9	2,5	○
44456B14	14x9	2,5	●



Ciotola, melamina
Bowl, melamine
Schüssel, Melamin
Bol, melamine
Bol, melamine

art.	dim. cm.	h.	col.
44457-32	32,5x14	4	○
44457B32	32,5x14	4	●



Piatto tondo, melamina
Round dish, melamine
Platte, rund, Melamin
Plat rond, melamine
Bandeja redonda, melamine

art.	ø cm.	h.	col.
44459-28	28	3	○
44459B28	28	3	●



Vassoio, melamina
Tray, melamine
Tablett, Melamin
Plateau, melamine
Bandeja, melamine

art.	dim. cm.	h.	col.
44461-20	20x20	4,5	○
44461B20	20x20	4,5	●



Vassoio, melamina
Tray, melamine
Tablett, Melamin
Plateau, melamine
Bandeja, melamine

art.	dim. cm.	h.	col.
44462-25	25x25	5,5	○
44462B25	25x25	5,5	●



Coppa riso, melamina
Rice bowl, melamine
Reistasse, Melamin
Bol à riz, melamine
Copa arroz, melamina

art.	ø cm.	h.	lt.
44463-11	11	7	0,3



Vassoio, melamina
Tray, melamine
Tablett, Melamin
Plateau, melamine
Bandeja, melamine

art.	dim. cm.	h.
44464-23	23,5x7,5	2



Vassoio, melamina
Tray, melamine
Tablett, Melamin
Plateau, melamine
Bandeja, melamine

art.	dim. cm.	h.
44465-24	24,5x6,5	1,5



N

Tazza soba choko con coperchio
Soba choko cup with cover
Soba Choko-Schale mit Deckel
Coupe soba choko avec couvercle
Taza soba choko con tapa

art.	ø cm.	h.
49655-47	8,5	6,5

Soba, piatto giapponese di grano saraceno. - Soba, a favorite Japanese buckwheat noodle dish.



Ciotola brodo/riso, melamina
Soup/rice bow with lid, melamine
Suppentasse-/Reisschüssel, Melamin
Bol à soupe/riz, melamine
Bol sopa/arroz, melamina

art.	ø cm.	h.
49655-34	10	10

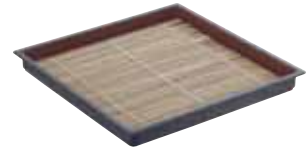

N

Vassoio zarusoba
Zaru soba tray
Zaru Soba-Tablett
Plateau zaru soba
Bandeja zaru soba

art.	dim. cm.
49655-48	19,5x19,5

Zaru Soba ovvero spaghetti freddi di grano saraceno.- Cold Soba Noodles.



N

Vassoio portatovagliolo
Towel tray
Handtuch-Tablett
Plateau à serviette
Bandeja servilleta

art.	dim. cm.
49655-46	17x7



Vassoio reversibile
Double Sided Tray
Platte
Plateau
Bandeja

art.	dim. cm.
49655-20	35x31



Scatola bento con coperchio
Bento box with lid
Bento-Box mit Deckel
Boîte à bento avec couvercle
Caja bento con tapa

art.	dim. cm.
49655-44	30x24



Vassoio bento
Bento tray
Bento-Platte
Plateau à bento
Bandeja bento

art.	dim. cm.	h.
49655-36	22x16	3,5/4



Scatola bento con coperchio
Bento box with lid
Bento-Box mit Deckel
Boîte à bento avec couvercle
Caja bento con tapa

art.	dim. cm.	h.
49655-37	24x24	5,5



Piatto a servire
Sushi serving dish
Sushi-Servierteller
Plat à sushi
Plato para sushi

art.	ø cm.	h.
49655-21	22	5,5
49655-22	25	6,0
49655-23	28	6,0



Perfetto per servire sushi o cirashi, una delle preparazioni tradizionali del sushi giapponese. La base è sempre il classico riso cotto che si sposa a meraviglia con il pesce crudo. Nel cirashi solitamente si utilizzano pesci carnosì come tonno, salmone, sgombrò, spada, ricciola e gamberi che si servono sopra il riso. - This sushi oke dish offers the perfect presentation for chirashi recipes. Chirashi is one of the traditional dishes of the Japanese sushi. The base is always the classic cooked rice perfect with the raw fish such as tuna, salmon, mackerel, sword, yellowtail and shrimps.



N

Barca presentazione sushi
Sushi boat presentation
Präsentations Sushi-Boot
Bateau présentation sushi
Barco presentación sushi

art.	dim. cm.	h.
49655-45	28x13,5	3,5-6



Piatto presentazione sushi bridge
Sushi bridge presentation platter
Sushi-Bridge
Plat de présentation sushi bridge
Plato de presentación sushi bridge

art.	dim. cm.	h.
49655-41	28x13,5	6



Barca presentazione sushi
Sushi boat presentation
Präsentations Sushi-Boot
Bateau présentation sushi
Barco presentación sushi

art.	dim. cm.	h.
49655-29	38x15	8

Bambù naturale. - Natural bamboo.



Tagliere sushi, bamboo
Bamboo Sushi Board Geta
Bambus-Sushibrett
Planche à sushi en bambou
Tabla para sushi de bambù

art.	dim. cm.	h.
49655-24	24x15	3



Tagliere sushi, PP
Sushi Board, PP
Sushibrett, PP
Planche à sushi, PP
Tabla para sushi, PP

art.	dim. cm.
49655-13	18x11,5



Supporto per temaki, legno
Wooden hand roll stand
Temaki-Ständer, Holz
Support pour temaki, bois
Soporte para temaki, madera

art.	dim. cm.	h.
49655-31	18x9	8,5

Supporto per temaki, laccato
Hand roll stand, laquered
Temaki-Ständer
Support pour temaki
Soporte para temaki

art.	dim. cm.	h.
49655-32	18x9,5	8

Perfetto per la presentazione del temaki. Contiene fino a tre pezzi. Temaki sushi è un tipo di sushi arrotolato a forma di cono. Il temaki è diverso dal sushi maki in quanto non si taglia a pezzi. La traduzione di "temaki" è arrotolato a mano. - Holds up to three pieces. Temaki sushi is a form of rolled sushi, created in a cone. Temaki is different from maki sushi, as you do not cut it into pieces. "Temaki" means hand roll.



Cucchiaino brodo, melamina
Soup spoon, melamine
Suppenlöffel, Melamin
Cuiller à soupe, melamine
Cuchara sopa, melamina

art.	dim. cm.
44850-13	13,5x4,5



Cucchiaino brodo, melamina
Soup spoon, melamine
Suppenlöffel, Melamin
Cuiller à soupe, melamine
Cuchara sopa, melamina

art.	dim. cm.
44850B13	13,5x4,5



Cucchiaino brodo, melamina
Soup spoon, melamine
Suppenlöffel, Melamin
Cuiller à soupe, melamine
Cuchara sopa, melamina

art.	l. cm.
49655-35	14,5



Salsierae, porcellana
Sauce pourer, porcelain
Sauciere, Porzellan
Saucière, porcelaine
Salsera, porcelana

art.	dim. cm.	h.	lt.
67305-57	7x11		0,20
67308-57	5x4	5,5	0,03



Piattino piano quadratoe, porcellana
Flat square plate, porcelain
Teller flach quadratisch, Porzellan
Petite assiette plate carrée, porcelaine
Platillo llano cuadrado, porcelana

art.	dim. cm.
67303Q80	9x9
67303Q81	12x12



Piattino fondo quadratoe, porcellana
Deep square plate, porcelain
Teller tief quadratisch, Porzellan
Petite assiette creuse carrée, porcelaine
Platillo hondo cuadrado, porcelana

art.	dim. cm.
67303Q82	9x9
67303Q83	12x12



Ciotolinae, porcellana
Small dish, porcelain
Schale, Porzellan
Petite assiette, porcelaine
Platillo, porcelana

art.	dim. cm.	h.
67303M01	9x7	3



Piattinoe, porcellana
Small dish, porcelain
Schale, Porzellan
Petite assiette, porcelaine
Platillo, porcelana

art.	dim. cm.	h.
67303M02	14x7	2



Piattinoe, porcellana
Small dish, porcelain
Schale, Porzellan
Petite assiette, porcelaine
Platillo, porcelana

art.	ø cm.	h.
67303M03	10	2



Piattinoe, porcellana
Small dish, porcelain
Schale, Porzellan
Petite assiette, porcelaine
Platillo, porcelana

art.	ø cm.	h.
67303M04	10,5	2



Ciotolinae, porcellana
Small dish, porcelain
Kleine Schale, Porzellan
Petite assiette, porcelaine
Platillo, porcelana

art.	dim. cm.
67303M05	11x8
67303M06	16x11



Cucchiaio cinesee, porcellana
Chinese spoon, porcelain
Porzellanlöffel, Porzellan
Cuillère chinoise, porcelaine
Cucharita, porcelana

art.	l. cm.
67303M07	13



Caraffa sake, porcellana
Sake jug, porcelain
Sakekrug, Porzellan
Carafe à sake, porcelaine
Jarra sake, porcelana

art.	ø cm.	h.	ml.	col.
49655-25	5,2	13,5	120	○
49655-42	5,7	18,0	250	○



Caraffa sake, porcellana
Sake jug, porcelain
Sakekrug, Porzellan
Carafe à sake, porcelaine
Jarra sake, porcelana

art.	ø cm.	h.	ml.	col.
49655-57	5,2	13,5	130	●
49655-58	5,7	18,0	230	●



Coppetta sake, porcellana
Sake cup, porcelain
Sakebecher, Porzellan
Coupe à sake, porcelaine
Copa sake, porcelana

art.	ø cm.	h.	ml.
49655-26	4,5	4,5	40



N

Coppetta sake, porcellana
Sake cup, porcelain
Sakebecher, Porzellan
Coupe à sake, porcelaine
Copa sake, porcelana

art.	ø cm.	h.	ml.	col.
49655-43	4,5	5,5	40	○
49655-60	4,5	5,5	40	●



N

Coppetta sake, porcellana
Sake cup, porcelain
Sakebecher, Porzellan
Coupe à sake, porcelaine
Copa sake, porcelana

art.	ø cm.	h.
49655-56	5	4



N

Riscalda sake, porcellana
Sake warmer, porcelain
Sakewärmer, Porzellan
Réchaud à sake, porcelaine
Calentador de sake, porcelana

art.	ø cm.	h.
49655-54	9,5	9



N

Caraffa sake, porcellana
Sake jug, porcelain
Sakekrug, Porzellan
Carafe à sake, porcelaine
Jarra sake, porcelana

art.	ø cm.	h.
49655-55	6	9,5



N

Vaso soia, porcellana
Soy pot, porcelain
Sojakrug, Porzellan
Carafe soja sauce, porcelaine
Jarra soja, porcelana

art.	ø cm.	h.	ml.
49655-53	5,5	8,5	130



N

Vaso soia, porcellana
Soy pot, porcelain
Sojakrug, Porzellan
Carafe soja sauce, porcelaine
Jarra soja, porcelana

art.	ø cm.	h.
49655-51	6,5	7



N

Vaso soia, porcellana
Soy pot, porcelain
Sojakrug, Porzellan
Carafe soja sauce, porcelaine
Jarra soja, porcelana

art.	ø cm.	h.
49655-52	12	7,5



N

Supporto bacchette cinesi, porcellana
Chopstick rest, porcelain
Ess-Stäbchen Ablage, Porzellan
Pose baguettes, porcelaine
Soporte para palillos, porcelana

art.	dim. cm.
49655-61	6x1,5



Supporto bacchette cinesi, porcellana
Chopstick rest, porcelain
Ess-Stäbchen Ablage, Porzellan
Pose baguettes, porcelaine
Soporte para palillos, porcelana

art.	dim. cm.
49655-28	4,5x3



Supporto bacchette cinesi, porcellana
Chopstick rest, porcelain
Ess-Stäbchen Ablage, Porzellan
Pose baguettes, porcelaine
Soporte para palillos, porcelana

art.	dim. cm.
49655-27	4,5x3



Bacchette, melamina
Chopsticks, melamine
Ess-Stäbchen, Melamin
Baguettes, melamine
Palillos, melamina

art.	l. cm.	paia/pairs
49658-01	27	10



Bacchette, melamina
Chopsticks, melamine
Ess-Stäbchen, Melamin
Baguettes, melamine
Palillos, melamina

art.	l. cm.	paia/pairs
49658-02	27	10



Bacchette, bamboo, monouso
Bamboo chopsticks, disposable
Bambus Ess-Stäbchen
Baguettes en bambou
Palillos de bambú

art.	l. cm.	paia/pairs
48300-29	21	50



Bacchette, bamboo, monouso
Bamboo chopsticks, disposable
Bambus Ess-Stäbchen
Baguettes en bambou
Palillos de bambú

art.	l. cm.	paia/pairs
49627-22	24	100

Fornite a coppie unite, in un sacchetto di carta. - Supplied in pairs, attached together, in a paper packet.



Bacchette giapponesi, colori assortiti
Japanese chopsticks, assorted colors
Japanische-Ess-Stäbchen
Baguettes japonaises
Palillos japoneses

art.	l. cm.
49628-00	24



Bacchette giapponesi, inox
Japanese chopsticks (hashi), s/s
Japanische-Ess-Stäbchen, E.R.
Baguettes japonaises, inox
Palillos japoneses, inox

art.	l. cm.	paia/pairs
49655-30	23	5



Spiedini noshikushi, bamboo
Noshikushi skewers, bamboo
Noshikushi Spieße, Bambus
Brochettes noshikushi, bambou
Pinchos noshikushi, bambú

art.	l. cm.	u. pack
48300-42	10,5	100



Spiedini tepokushi, bamboo
Tepokushi skewers, bamboo
Tepokushi Spieße, Bambus
Brochettes tepokushi, bambou
Pinchos tepokushi, bambú

art.	l. cm.	u. pack
48300-43	9	100
48300-33	15	100



Vetrina antipasti
Tapas display
Vorspeisen-Schaufenster
Vitrine tapas
Vitrina para tapas

art.	dim. cm.	h.	temp.	V	W	kg
49630-06	145x40	26	+2/+5°C	230	160	33
49630-08	180x40	26	+2/+5°C	230	160	40

Costruzione in acciaio inox e finitura in alluminio anodizzato. Porte posteriori scorrevoli in plexi, rimovibili, vetro frontale curvo, sollevabile. Dispositivo di scarico, interruttore on/off, interruttore LED, compressore, condensatore ed evaporatore, termostato elettronico, gas T134 privo di CFC. Temperatura: +1°C/+5°C. Dotazione: 6/8 contenitori GN 1/3 altezza 40 mm. - Stainless steel construction and finishing in anodized aluminum. Removable rear sliding doors in plexi, liftable curved front glass. Draining device, on/off switch, LED switch, compressor, condenser and evaporator, electronic thermostat, gas T134 CFC free. Temperature: +1°C/+5°C. Delivered with 6/8 GN 1/3 containers, height 40 mm.



Stuoietta bamboo
Bamboo sushi mat
Bambus-Sushi-Matte
Natte à rouler les sushis en bambou
Mantelín de bambú para sushi

art.	dim. cm.
49626-00	24x24

Stuoietta bamboo
Bamboo sushi mat
Bambus-Sushi-Matte
Natte à rouler les sushis en bambou
Mantelín de bambú para sushi

art.	dim. cm.
49626-02	27x27



Tappetino per sushi, silicone
Sushi mat, silikon
Sushi-Rollen Matte, Silikon
Natte à rouler le sushis, silikon
Mantelín para sushi, silicona

art.	dim. cm.
49655-11	25x26



Kit per sushi-maki
Sushi maki set
Sushi-Maki-Satz
Utensile pour sushis-maki
Juego para sushi-maki

art.	ø cm.	l.
49655-01	6	30

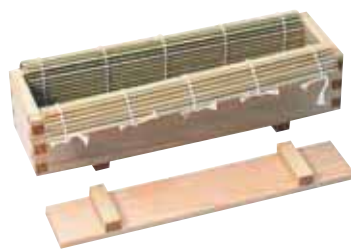

Kit 3 pz per sushi-maki
Sushi-maki set 3 pcs
Sushi-Maki-Satz 3 Stk
Kit 3 pcs pour réaliser les sushi-maki
Juego 3 pz para sushi-maki

art.	dim. cm.	h.
49655-02	26x7,5	5,5



Stampo per sushi
Sushi roll mould
Sushi-Ausstechform
Moule à sushi
Molde para sushi

art.	sushi dim. cm.	pcs
49655-08	5x2,5	10



Stampo per maki
Maki roll mould
Maki-Ausstechform
Moule à maki
Molde para maki

art.	dim. cm.	h.
49655-10	20,5x4	4



Stampo per nigiri
Nigiri mould
Nigiri-Ausstechform
Moule à nigiri
Molde para nigiri

art.	dim. cm.
49655-16	5,5x3



Cucchiaio riso
Rice spoon
Reislöffel
Cuiller à riz
Cuchara arroz

art.	dim. cm.
49655-03	22x7



Cuocivapore, bambou
Bamboo steamer
Bambus Dampfgarer
Panier vapeur en bambou
Vaporera bambú redonda

art.	ø cm.
49603-15	16
49603-20	20
49603-25	25
49603-30	30
49603-40	40
49603-50	50

2 ceste + 1 coperchio. - 2 bodies + 1 cover.



Cuocivapore, bambou
Bamboo steamer
Bambus Dampfgarer
Panier vapeur en bambou
Vaporera bambú redonda

art.	dim. cm.
49656-15	15,2x15,2
49656-16	16,5x16,5
49656-20	20,3x20,3



Vasca riso hangiri
Hangiri/sushi rice tub
Hangiri/Sushi-Reis-Wanne
Cuve à riz sushi/hangiri
Barril arroz sushi/hangiri

art.	ø cm.
49655-49	45
49655-50	60

N



Cuoci riso a vapore
Rice steamer
Reiskocher
Cuit riz
Olla para riz

art. ø cm. h. lt. V W Kg riso/rice
49954-21 50 35 21 220 3000 10

W	Tazze / Cups	KG Riso / Rice
1100	8 -12	2,8
1250	10 -15	3,8
1600	15 -20	4,6
1950	20 -25	5,7
2500	25 -30	8,2
2800	30 -35	8,8
3000	35 -40	10,0



Vaporiera, inox
Steamer, stainless steel
Dampfer, Edelstahl Rostfrei
Cuit vapeur, inox
Olla para cocinar al vapor, inox

art. ø cm. h. kg. V W lt.
49954-18 38 46 7 230 2000 15

Per cottura a vapore o immersione: ideale per sottovuoto, uova, pesce, frutti di mare, verdure. Riduce i tempi di cottura dal 20 al 50%. Capacità: 10 kg di verdure. - For steaming or vacuum: ideal for vacuum food, eggs, fish, seafood, vegetables. It reduces cooking time by 20 to 50%. Capacity: 10 kg of vegetables.



Wok c/griglia e coperchio, 3-ply
Wok with grid and cover, 3-ply
Wok mit Rost und Deckel, 3-ply
Wok avec grille et couvercle, 3-ply
Wok con rejilla y tapa, 3-ply

art. ø cm. h.
12529-32 32 8



Wok, ferro
Steel wok pan
Wok-Eisenpfanne
Poêle chinoise, acier
Wok, hierro

art. ø cm. h.
11713-32 32 10
11713-40 40 11



Wok, ferro
Steel wok pan
Wok-Eisenpfanne
Poêle chinoise, acier
Wok, hierro

art. ø cm. h.
49604-31 30,5 9
49604-36 35,5 11
49604-41 40,5 12



Wok antiaderente
Non stick wok
Wok-Pfanne, nichttaftend
Poêle chinoise, anti-adhérente
Wok, antiadherente

art. ø cm.
49612-30 30,5
49612-33 33,0
Fondo piano. - Flat bottom.



Base per wok, cromata
Wok stand, chromed
Fuss für Wokpfanne, verchromt
Base pour wok, chromée
Base para Wok, cromada

art. ø cm. h.
49600-00 20-25 5,5



Griglia per tempura, cromata
Tempura rack, chromed
Tempura-Rost, verchromt
Grille à tempura, chromée
Rejilla para tempura, cromada

art. ø cm.
49613-30 30,5
49613-33 33,0
49613-35 35,5

La griglia sul wok mantiene in caldo il cibo che ha terminato la cottura, mentre l'olio cola nel wok.
The tempura rack attached to the wok holds food that has finished cooking, so that it stays warm while oil drains back into the wok



La tempura è un piatto tipico della cucina giapponese che consiste in un fritto croccante e leggero, fatto di verdure e pesce. Il nome deriva dal termine latino "tempora" che indica quattro periodi dell'anno corrispondenti alle quattro stagioni; in questi frangenti di tempo i cristiani evitavano di mangiare carne, nutrendosi solo di pesce e verdure. Si narra che, durante il XVI secolo, alcuni missionari portoghesi giunsero sino in Giappone e qui fecero conoscere al popolo del Sol Levante la tradizione dei tempura; consuetudine che fu poi personalizzata dai giapponesi che iniziarono a friggere verdure e pesce con una pastella leggera. - The tempura is a typical Japanese dish consisting in fried vegetables and fish, crispy and light. The name of this food comes from the Latin term "tempora" indicating four periods of the year corresponding to the four seasons during which Christians abstain from eating meat, eating only fish and vegetables. The story goes that during the sixteenth century, Portuguese missionaries arrived in Japan and taught the people of the Rising Sun the tradition of tempura. Later on this dish has been customized by the Japanese who began to fry vegetables and fish with a light batter.



Wok, ferro
Steel wok pan
Wok-Eisenpfanne
Poêle chinoise, alier
Wok, hierro

art.	ø cm.	h.
49605-46	45,5	14,0
49605-61	61,0	18,5
49605-71	71,0	22,0



Coperchio per wok, alluminio
Wok lid, aluminum
Wok-Deckel, Aluminium
Couvercle pour poêle chinoise, alu
Tapa para wok, aluminio

art.	ø cm.	h.
49602-25	25	4
49602-30	29	4
49602-33	33	4
49602-35	35	4



Base per wok, inox
Wok stand, stainless steel
Fuss für Wokpfanne, Edelstahl Rostfrei
Base pour wok, inox
Base para Wok, inox

art.	ø cm.
11953-22	22



Padella balti/karahi
Balti pan
Balti-Pfanne
Poêle balti
Sartén balti

art.	ø cm.
49657-15	15,2
49657-20	20,3
49657-25	25,4



Balti e karahi sono lo stesso stile di cucina, originario del Kashmir, dove le pietanze al curry sono realizzate in una padella in ghisa con fondo arrotondato e due maniglie, simile ad un wok cinese. Spezie tipiche utilizzate sono: anice, cardamomo, corteccia di cassia, chiodi di garofano, coriandolo, cumino, finocchio, zenzero e una miscela di spezie chiamata garam masala. Spesso questi pasti vengono consumati senza riso o posate, utilizzando un pane indiano detto naan. - **Balti and karahi are the same style of cooking, originating in Kashmir, where the curries are made in a cast-iron pan with a rounded bottom and two handles, rather like a Chinese wok. Typical spices used in balti curries are aniseed, cardamom, cassia bark, cloves, coriander, cumin, fennel, ginger and the spice blend called garam masala. Balti curries are often eaten without rice or cutlery, using large, flat breads such as naan.**



Padella balti base legno
Balti pan with wood base
Balti-Pfanne mit Holz-Basis
Poêle balti avec base en bois
Sartén balti base de madera

art.	ø cm.
49656-02	15,2



Casseruola con coperchio e sottopentola
Pot with lid and trivet
Kasserolle+Deckel+Untersetzer
Casserole avec couvercle et sous-plat
Cacerola con tapa y posavasos

art.	ø cm.
49655-63	17
49655-64	21
49655-65	15



Per cucinare al salto, in forno, microonde, ecc., oltre ad essere uno strumento di cottura si utilizza per servire direttamente in tavola. Toban (traduzione letterale "padella ceramica"), è una padella tradizionale giapponese utilizzata anche come piatto. - **Steak, stir-fry, quick suki-yaki, oven-baking, or even microwave cooking etc., Iga-yaki toban (donabe skillet) is a unique cookware as well as a serving dish at the same time. Toban (literally translates into "ceramic skillet"), is one of traditional-style Japanese cookware which can work as skillet or shallow pot.**



Padella Toban
Toban skillet
Toban-Pfanne
Poêle Toban
SarténToban

art.	ø cm.
49655-40	19



Padella per friggere, ferro
Steel fry pan
Frittier-Eisenpfanne
Tuile à frire, acier
Sartén freidora, hierro

art.	Ø cm.	h.	lt.
41707-32	32	9,8	6,0
41707-36	36	11,0	8,8
41707-40	40	13,4	12,2
41707-45	45	15,0	17,3
41707-50	50	17,6	23,5



Cestello per friggere, stagnato
Wire basket, tinned
Frittier-Rost, verzinkt
Grille à frire, étamée
Cesta escurrefrito, estañada

art.	Ø cm.	h.
41708-32	32	11,0
41708-36	36	11,5
41708-40	40	12,4
41708-45	45	15,5
41708-50	50	16,5



Padella omelette, antiaderente
Japanese omelettes pan, non-stick
Japanische Omelette Pfanne mit Antihafbeschichtung
Poêle à omelettes, revêtement anti-adhésif
Sartén antiadherente para tortillas japonesas

art.	dim. cm.	h.
49655-38	22x24	3,5



Padella tawa, ferro
Steel tawa pan
Tawa-Eisenpfanne
Poêle tawa, acier
Sartén tawa, hierro

art.	Ø cm.
49614-28	28

Queste padelle piane sono utilizzate nella cucina indiana, per focacce e tutto ciò che ha bisogno di cottura rapida ad alta temperatura. L'anatra di Bombay a volte viene cucinata su tawa. CURIOSITA': L'anatra Bombay o bummalo, nonostante il nome, non è una papera, ma bensì un pesce. E' originario delle acque tra Mumbai (ex Bombay) e Kutch nel Mar Arabico. - These flat pans are used in Indian cooking, for chapattis and anything that needs quick cooking at high temperatures. Bombay duck or bummalo is, despite its name, not a duck but a lizardfish. It is native to the waters between Mumbai (formerly Bombay) and Kutch in the Arabian Sea.



Chapattis



Cuocivapore, inox
Steamer, stainless steel
Dampf-Kocher, Edelstahl Rostfrei
Cuisneur à vapeur, inox
Cuscusera, inox

art.	Ø cm.	h.	
49606-51	51	14	base
49606-00	51	14	inserto - body
49606-01	51	20	coperchio - cover



Vengono utilizzati con la fonduta cinese per contenere gli alimenti durante la cottura nel brodo. - These mesh scoops are used with the Chinese hot pot, to hold food while it is cooking in the pot.



Porzionatore
Scoop
Portionierer
Cuiller
Racionador

art.	
49616S01	inox - s/s
49616B01	ottone - brass



Pentola cinese, alluminio
Chinese hot pot, aluminium
Chinese- Suppentopf, Alu
Marmite chinoise, alu
Olla chino, alumínio

art.	ø. cm.	h.
49616-22	22	17
49616-24	24	20
49616-26	26	22



Casseruola terracotta
Clay pot
Tontopf
Pot d'argile
Olla de barro

art.	ø. cm.	h.	kg.
49632-24	23	10	1,5
49632-32	32	16	2,7



Casseruola terracotta
Clay pot
Tontopf
Pot d'argile
Olla de barro

art.	ø. cm.	h.	kg.
49633-22	22	10	0,75
49633-24	24	12	1,35



Piatto ghisa con vassoio legno
Sizzler platter, cast iron
Gusseisenplatte
Plat en fonte
Fuente hierro fundido

art.	dim. cm.	dim. cm. ext.
49615-01	22x15	33,5x22



Piatto con supporto legno
Oval plate with wooden platter
Ovalplatte mit Holzbrett
Plat oval avec planche bois
Fuente ovale con tabla madera

art.	dim. cm.
44223S19	12,5x19



Padella grill, alluminio antiaderente
Grill pan, aluminum, non-stick coated
Grill-Pfanne, Aluminium, nichttafend
Poêle à griller, alu, anti-adhérente
Sartén grill, aluminio, antiadherente

art.	dim. cm.	h.
16971-36	36,5x22,5	3,5



Mortaiò e pestello
Mortar and pestle
Mörser und Stößel
Mortier et pilon
Mortero y pistilo

art.	ø. cm.	h.	kg.
49618-12	9	10,5	2,6
49618-15	11	12,0	4,1
49618-18	14	13,5	5,8



Oliera, inox
Oil pourer, stainless steel
Ölkanne, Edelstahl Rostfrei
Huilière, inox
Alcuza, inox

art.	ø. cm.	h.	ml.
49631-08	7	11,5	400
49631-11	11	17,0	1.000



Colapasta
Noodle strainer
Nudeln-Sieb
Passoire
Colador

art.	ø. cm.	h.	l.
49601-14	14	13	22

Inox e legno naturale.
Stainless steel and natural wood.

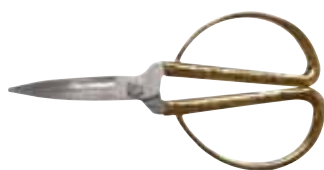

Forbice carni
Meat scissors
Fleischschere
Ciseaux à viande
Tijeras para carne

art.	l. cm.
49636-00	17



Pinza per anatra
Duck fur pincer
Ente Fell Zange
Pince à canard
Pinza pato

art.	l. cm.
49637-00	15



Squamapesce
Fish scaler
Fischentschupper
Ecailleur à poisson
Escamador

art.	l. cm.
49638-00	22

CUCINA ETNICA ETHNIC CUISINE



Schiumarola fritto, rete grossa
Fry basket, coarse mesh
Frittierkorb
Panier de friture
Cesta para freír

art.	ø cm.
49607-15	15,0
49607-20	20,0
49607-25	25,5
49607-30	30,5



Schiumarola fritto, rete fine
Fry basket, fine mesh
Frittierkorb
Panier de friture
Cesta para freír

art.	ø cm.
49608-15	15,0
49608-20	20,0
49608-25	25,5
49608-30	30,5
49608-35	35,5



Schiumarola
Skimmer
Schaumlöffel
Ecumoire
Espumadera

art.	ø cm.	l.
49617-23	24	45
49617-25	26	46
49617-30	30	50

Manico bamboo, rete inox. - **Bamboo handle, stainless steel mesh.**



Mestolo
Ladle
Schöpflöffel
Louche
Cacillo

art.	ø cm.
49609-12	11,8
49609-14	13,8



Paletta
Spatula
Teigschäber
Spatule
Espátula

art.	dim. cm.
49610-11	11x10,2
49610-14	13,3x12

Inox e legno naturale. - **Stainless steel and natural wood.**



Bastoncini per cucinare, bamboo
Hashi cooking chopsticks
Bambus Kochstäbchen
Baguettes de cuisine en bambou
Palillos para cocinar de bambú

art.	l. cm.	paia/pairs
49629-45	45	1

Monouso. - **Disposable.**



L'originale spazzola cinese è fatta di strisce di bambù tenute insieme ad un'estremità ed usata per pulire il Wok sotto l'acqua corrente. - **The original Chinese wok cleaning brush is made of strips of Bamboo held together at the top and used to clean out the wok under running water.**



Grattugia per wasabi
Wasabi grater
Wasabi-Raffel
Rape à wasabi
Rallador para wasabi

art.	dim. cm.
42555-11	11x7,5



Pennello per wok, bamboo
Bamboo wok brush
Wok-Pinsel, Bambus
Pinceaux à wok, bambou
Pincel para wok, bambú

art.	l. cm.
49634-00	25,5



Spazzola per wok
Wooden handled wok brush
Wok-Bürste, Holzgriff
Brosse à wok, manche bois
Cepillo para wok, mango madera

art.	l. cm.
49635-00	27,5

COLTELLI SUSHI GIAPPONESI P

JAPANESE SUSHI KNIVES



Una scelta eccellente per la preparazione di sushi e verdure. Lame in acciaio inox, molibdeno e vanadio, per un'ottimale tenuta del filo, affilatura a rasoio, manici in legno antiscivolo. Secondo la tradizione giapponese l'affilatura è unilaterale ed il filo è molto più sottile rispetto a quello della normale affilatura dei coltelli occidentali. Questo rende i tagli più nitidi ed evita di creare traumi alla trama delicata di carne e pesce crudo. Non utilizzare per il taglio di solidi incluse grosse lisce di pesce. Data la particolarità dell'affilatura e dell'acciaio impiegato si consiglia vivamente di lavare a mano ed asciugare immediatamente con cura le lame.

Excellent choice when preparing sushi and vegetables. Molybdenum/Vanadium s/s blades for excellent edge retention, razor sharp edges, slip resistant wooden handles. The blades are sharpened with the traditional Japanese single bevel to improve sharpness. The large beveled one-sided edge is much thinner than a two-sided edge. This thinner, sharper edge makes for cleaner cuts through the soft flesh of fish, in particular. Using these knives will avoid bruising the delicate texture of raw fish and destroying the freshness of the fish. The thinner edge is more fragile than the edge on western knives. Do not use for cutting anything solid including larger fish bones. Due to the special blade sharpening and s/s used we highly recommend to only hand wash and dry the blades thoroughly immediately.

DEBA

Affilato e dalla lama pesante usato per disossare e tagliare il pesce utilizzato nel sushi. È simile ad un coltello da chef. - The Deba is a powerful knife used for filleting fish and butchering meat without bones. Its weight and thickness can chop through fish bones and the sharp edge can fillet even the smallest of fish.

art.	l. cm.
18280-22	22,5
18280-16	16,5
18280-10	10,5



OROSHI

Per sfilettare il tonno e altri pesci di grandi dimensioni. An Oroschi Knife is a Japanese all-purpose cooking knife, but used particularly for fish.

art.	l. cm.
18281-24	24



USUBA

Coltello estremamente affilato con una punta quadrata. Questo coltello è usato per tagliare verdure e quando è tenuto ben affilato può tagliarle in fette sottili come un foglio di carta. - The Usuba is the ultimate vegetable knife. Sharp and thin, it is used by chefs in Japan for katsuramuki, a traditional style of peeling vegetables into thin sheets.

art.	l. cm.
18282-22	22,5
18282-18	18,0
18282-19*	18,0

*doppia affilatura
*double bevel



TAKO SASHIMI

Il coltello Tako Sashimi assomiglia di più ad un coltello occidentale ed è utilizzato per affettare tagli spessi di carne per sushi. Ha la lama senza punta, per evitare di rovinare i tentacoli del polpo. - The Tako Sashimi is a variation of the Yanagi and is used to slice straight-cut sashimi. The blunt tip and balanced weight works well on difficult ingredients like octopus, from which it gets its name. Originated in Kanto (Tokyo) region.

art.	l. cm.
18283-33	33
18283-27	27



YANAGI SASHIMI

Viene utilizzato per tagliare sottili fette di verdure, carne o pesce, nonché per tagliare in generale a dadi o a fette. Grazie alla sua lama sottile ed affilata è utilizzato anche per creare guarnizioni o tagliare i rotoli di sushi. The Yanagi Sashimi is a slicing knife used to cut boneless fish fillets into sashimi and topping for sushi. The graceful, thin blade cuts beautiful slices in one long, drawing stroke. Originated in Kansai (Osaka) region.

art.	l. cm.
18284-21	21
18284-27	27
18284-30	30
18284-33	33



APPARECCHI ELETTRICI *ELECTRIC APPLIANCES*

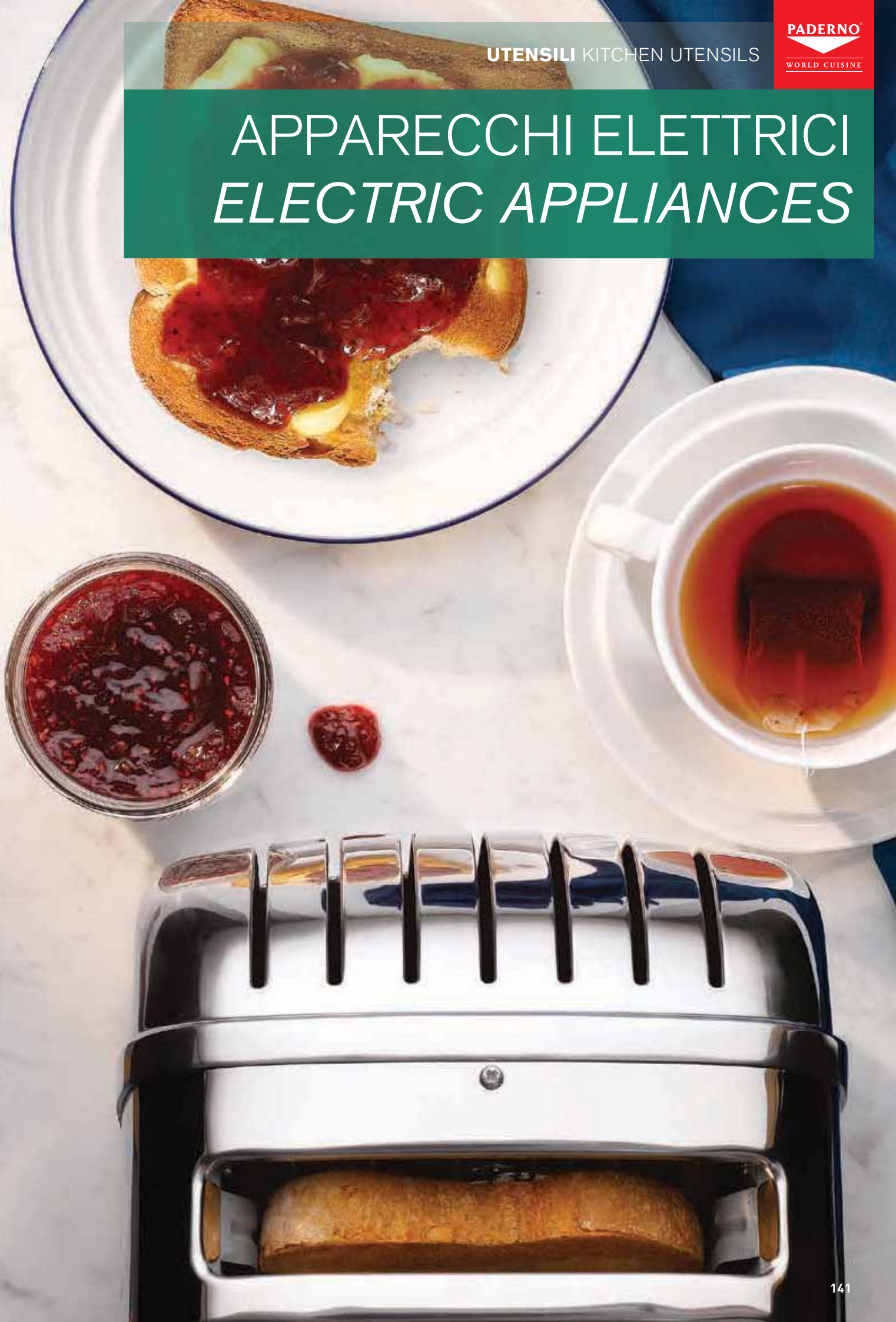



N

Tostapane 4 fette
4 slot toaster
Brotröster
Grille pain
Tostadora

art.	dim. cm.	h.	KW	kg.
49801-04	36x21	22	2,2	4,25

Produzione oraria: 130 fette. Larghezza fessure: 28 mm. Terminali in alluminio pressofuso, corpo in acciaio inox. - Output per hour 130 slices. Slot width: 28 mm. Cast aluminium ends, stainless steel body.

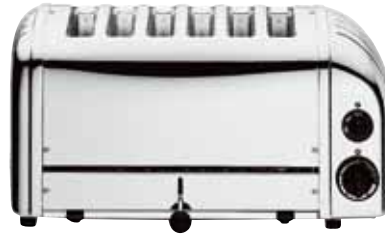

N

Tostapane 6 fette
6 slot toaster
Brotröster
Grille pain
Tostadora

art.	dim. cm.	h.	KW	kg.
49801-06	46x21	22	3	5,1

Produzione oraria: 240 fette. Larghezza fessure: 28 mm. Terminali in alluminio pressofuso, corpo in acciaio inox. - Output per hour 240 slices. Slot width: 28 mm. Cast aluminium ends, stainless steel body.



N

Tostapanini 4 fette
4 slice bun toaster
Brotröster
Grille pain
Tostadora

art.	dim. cm.	h.	KW	kg.
49802-04	36x21	22	1	4,52

Per 1 o 2 panini (4 metà). Produzione oraria 70 panini. Larghezza fessure: 28 mm. Altezza fessure 115 mm. Per tostare panini di diametro 115 mm. Capacity 1 or 2 buns (four halves). Output per hour 70 buns. Slot width 28 mm. Slot height 115 mm, to toast 115mm diameter buns.



N

Tostapanini 6 fette
6 slice bun toaster
Brotröster
Grille pain
Tostadora

art.	dim. cm.	h.	KW	kg.
49802-06	46x21	22	1,5	5,52

Capacità 1, 2 o 3 panini (sei metà). Produzione oraria 105 pezzi. Larghezza fessure 28 mm. Altezza 115mm. Per tostare panini di diametro 115 mm. Capacity 1, 2 or 3 buns (six halves). Output per hour 105 buns. Slot width 28 mm. Slot height 115 mm, to toast 115 mm diameter buns.





N



Tostapane a nastro
Conveyor Toaster
Durchlauf-Toaster
Toaster convoyeur
Tostador a túnel

Tostapane a nastro doppia uscita, CT 540 B
Conveyor toaster
Durchlauf toaster
Toaster convoyeur
Tostador a túnel

art.	dim. cm.	h.	KW	V	kg.
49803-02	37x64	40	2,8	230	20

art.	dim. cm.	h.	V	KW	kg.
49850-20	50x68	34,5	230	2,65	20

Produce fino a 360 fette all'ora, controllo termostatico per mantenere la temperatura di tostatura attivandosi e spegnendosi quando il tostapane è inattivo. - The toaster produces up to 360 slices an hour, it maintains the toasting temperature by cycling on and off when the toaster is idle.



Tostapane, BAR 1000
Toaster
Toast-/Überbackgerät
Toaster
Tostador de pan

Tostapane, BAR 2000
Toaster
Toast-/Überbackgerät
Toaster
Tostador de pan

art.	dim. cm.	h.	V	KW	kg.
49850-65	45x28,5	30,5	230	2	10

art.	dim. cm.	h.	V	KW	kg.
49850-66	45x28,5	42	230	3	12



Grill a contatto, SAVOYE
Contact grill
Kontaktgrill
Grill à contact
Grill de contacto

Grill a contatto, PANINI
Contact grill
Kontaktgrill
Grill à contact
Grill de contacto

art.	dim. cm.	h.	V	KW	kg.
49850-22	33x38,5	22	230	2	18

art.	dim. cm.	h.	V	KW	kg.
49850-21	43x38,5	22	230	3	22,5



Grill a contatto doppia piastra, MAJESTIC
Contact grill double plate
Kontaktgrill, 2 Platten
Grill à contact, 2 plaques
Grill de contacto doble

art.	dim. cm.	h.	V	KW	kg.
49850-23	60x38,5	22	380	4	33,5
Oppure/Or		230	2x2		



Grill a contatto
Contact sandwich toaster
Sandwich-Toaster
Appareil croque monsieur
Grill de contacto

N

art.	dim. cm.	h.	V	KW	kg.	output/h
49806-00	40x22	19	1,6	6	60	

Per panini tostati a forma di triangolo; il profondo stampaggio antiaderente e la tenuta robusta permette generosi ripieni. Le due piastre possono essere utilizzate singolarmente. - **Makes delicious, sealed toasted sandwich triangles; their deep non-stick moulding and robust seal means that fillings can be extremely generous. The two hotplates can be operated individually.**



Grill a contatto, PANINI XL
Contact grill
Kontaktgrill
Grill à contact
Grill de contacto

art.	dim. cm.	h.	V	KW	kg.
49850-19	41x62	34	230	3,6	32



Grill a contatto vetroceramica, PANINI VC
Glas ceramic contact grill
Kontaktgrill, Glaskeramik-Platte
Grill à contact vitrocéramique
Grill de contacto vitrocéramica

art.	dim. cm.	h.	V	KW	kg.
49850-18	39x62	24	230	1,5	13



Piastra in vetroceramica, PS 400 VC
Glass ceramic griddle plate
Glaskermik-Grillplatte
Plaque à snacker vitrocéramique
Plancha hasadora vitrocéramica

art.	dim. cm.	h.	V	KW	kg.
49850-60	39x42	15	230	1,5	7



Piastra in acciaio smaltato, PSR 600 EE
Griddle plate in enamelled steel
Grillplatte aus emailiertem Stahl
Plaque à snacker acier émaillé
Plancha de acero esmaltado

art.	dim. cm.	h.	V	KW	kg.
49850-59	60x47,5	23	220	2x3	29



Salamandra, SEM 600 PDS
 Salamander with Plate Detection System
 Salamanders mit PDS
 Salamandre avec détection de plat
 Salamandra con PDS



art.	dim. cm.	h.	V	KW	kg.	int. dim. cm.
49850-71	60x64	59	230	3	56	49,5x37,5



Griglia kebab/gyros, GR 40/60 E
 Kebab/Gyros grill
 Elektro-Dönergrill
 Gril à kebab/gyros
 Asador de kebab/gyros

art.	dim. cm.	h.	V	KW	kg.	kg. carne/meat
49850-13	58x66	69,5	230	3,6	27	15
49850-14	58x66	87,0	380	5,8	31	25



Scalda würstel, CS 3 E
 Hot dog heater
 Würstchenwärmer
 Chauffe-saucisses
 Calentador de salchichas

art.	dim. cm.	h.	V	KW	kg.
49850-61	44x30	40	230	0,65	9



Crepiera tonda, ad alto rendimento, CFE 400
 Crepe machine, high-capacity
 Crêpegerät
 Crêpière à haut rendement
 Crepera



art.	ø cm.	h.	V	KW	kg.
49850-33	40	20	230	3,6	18



Crepiera doppia, CDE 400
 Double crepe machine
 Crêpegerät, 2 Platten
 Crêpière double
 Crepera 2 placas

art.	dim. cm.	h.	V	KW	kg.
49850-12	86x50	24	380	7,2	44
Oppure/Or			230	2x3,6	



Crepiera singola, CSE 400
 Single crepe machine
 Crêpegerät
 Crêpière simple
 Crepera

art.	dim. cm.	h.	V	KW	kg.
49850-11	45x50	24	230	3,6	23



Bollitore uova, CO 60
Eggs boiler
Eierkocher
Cuiseur à oeuf
Caldera para huevos

art.	dim. cm.	h.	V	KW	kg.
49850-36	21,5x43	25,5	230	1,2	4,5



Forno multifunzione, FC 280
Multifunction oven
Multifunktionsofen
Four multifonctions
Horno multifunción

art.	dim. cm.	h.	V	KW	kg.	int. dim. cm.
49850-73	46x55	35,5	230	1,5	20	32x32,5x26,5



Forno multifunzione, FC 380 TQ
Multifunction oven
Multifunktionsofen
Four multifonctions
Horno multifunción

art.	dim. cm.	h.	V	KW	kg.	int. dim. cm.
49850-75	55x55	35,5	230	2,4	22	41,5x35x26,5



Forno multifunzione 4 GN 2/3, FC 60 TQ
Multifunction oven
Multifunktionsofen
Four multifonctions
Horno multifunción

art.	dim. cm.	h.	V	KW	kg.	int. dim. cm.
49850-76	59,5x61	59	230	3	38	47x37x35



Forno verticale "salvaspazio", FCV 280
Senkrechter Ofen
Vertical-Backofen
Four vertical
Horno vertical

art.	dim. cm.	h.	V	KW	kg.	int. dim. cm.
49850-74	37x53	49,5	230	1,5	20	26x33x32



Forno a nastro, CT3000
Conveyor oven
Durchlaufofen
Four conveyeur
Horno a túnel

art.	dim. cm.	h.	V	KW	kg.	int. dim. cm.
49850-72	47x72	38,5	230	3	22	30x37



Friggitrice, FD 80 R
 Fryer
 Fritteuse
 Friteuse
 Freidora

art.	dim. cm.	h.	V	KW	kg.	kg/h	int. dim. cm.
49850-41	26,5x45	36	230	3,6	8	15	22x26x10



Friggitrice, FD 80 DR
 Fryer
 Fritteuse
 Friteuse
 Freidora

art.	dim. cm.	h.	V	KW	kg.	kg/h	int. dim. cm.
49850-42	59x45	37	230	2x3,6	15	30	2x22x26x10



Friggitrice, FD 50 / FD 50 D
 Fryer
 Fritteuse
 Friteuse
 Freidora

art.	dim. cm.	h.	V	KW	kg.	kg/h	int. dim. cm.
49850-37	21,5x42,5	32	230	3,2	5	10	14x26x10
49850-39	39x42,5	32	2x230	2x3,2	10	20	2x14x26x10

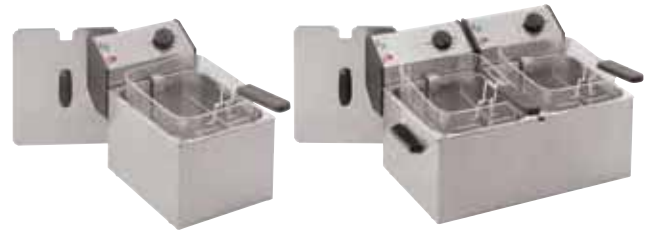

Friggitrice, FD 80 / FD 80 D
 Fryer
 Fritteuse
 Friteuse
 Freidora

art.	dim. cm.	h.	V	KW	kg.	kg/h	int. dim. cm.
49850-38	28x42,5	32	230	3,6	7	15	22x26x10
49850-48	54x42,5	32	2x230	2x3,6	12	30	2x22x26x10



Schiumalatte
 Milk steamer
 Milchdampfer
 Emulsionneur à lait
 Vaporizador de leche

art.	dim. cm.	h.	lt.	KW	kg.
49805-10	14x31	34	0,85	1,45	5,6



Scaldapiatti, DW106 / 110
 Dish-warmer
 Rechaud
 Chauffe plats
 Calentador de platos

art.	dim. cm.	h.	V	KW	kg.
49850-06	40x21,5	33,5	220	0,65	14
49850-10	40x21,5	47,5	220	1,30	25



Espositore caldo ventilato, WD 780 SI
Ventilated warming display
Konvektion-Warme Theke
Présentoir chaud à convection
Expositor caliente con convección

art.	dim. cm.	h.	KW	kg.
49850-69	78x49	48	1,2	30



Espositore caldo ventilato, WD 780 DI
Ventilated warming display
Konvektion-Warme Theke
Présentoir chaud à convection
Expositor caliente con convección

art.	dim. cm.	h.	KW	kg.
49850-70	78x49	64	1,8	35



Vetrina riscaldata
Warming display
Warmhalte-Vitrine
Vitrine chauffante
Vitrina caliente

art.	dim. cm.	int.dim. cm.	GN	Kg.	range	V	KW
49850-43	59x35x28,5	24x33x16,5	1/1	12	+20 +95°C	230	0,65



Vetrina riscaldata
Warming display
Warmhalte-Vitrine
Vitrine chauffante
Vitrina caliente

art.	dim. cm.	int.dim. cm.	GN	Kg.	range	V	KW
49850-44	59x35x39	24x33x12,5(x2)	2x1/1	15	+20 +95°C	230	0,65

Caratteristiche: termostato (20-95°C), cassetto acqua, interruttore on/off, spia luminosa, piedini regolabili. Disponibile in 2 colori: oro e acciaio inox. Fornite senza vassoio GN 1/1. - Features: thermostat (20-95°C), water container, on/off switch, pilot light, adjustable feet. Available in 2 colours: gold and stainless steel. Delivered without any GN1/1.



Piano caldo
Warming plate
Wärmeplatten
Plaque chauffante
Placa caliente



art.	dim. cm.	h.	V	KW	GN
49990-11	33x53	6	230	0,50	1/1
49990-21	63x53	6	230	0,75	2x1/1
49990-31	98x53	6	230	1,50	3x1/1
49990-41	130x53	6	230	1,50	4x1/1



Piano caldo
Warming plate
Wärmeplatten
Plaque chauffante
Placa caliente



art.	dim. cm.	h.	V	KW
49990-50	50x50	6	230	0,75
49990-60	60x40	6	230	0,75

Inox AISI 304. Riscaldamento a secco con termostato meccanico (+30°/+90°C) e spia luminosa. - AISI 304 stainless steel structure. Dry-heating with mechanical thermostat (+30°/+90°C) with indicator light.



Lampada ad infrarossi, cromata
 Infrared lamp, chromed
 Infrarot Wärmebrücke, chromiert
 Lampe chauffante infra-rouge, chromate
 Lámpara infrarrojos, cromado



GN 1/1

art.	dim. cm.	h.	V	W
49991-11	64x28	86	230	250



Lampada ad infrarossi, cromata
 Infrared lamp, chromed
 Infrarot Wärmebrücke, chromiert
 Lampe chauffante infra-rouge, chromate
 Lámpara infrarrojos, cromado



GN 1/1 1/1

art.	dim. cm.	h.	V	W
49991-21	75x53	72	230	500



Lampada ad infrarossi, cromata
 Infrared lamp, chromed
 Infrarot Wärmebrücke, chromiert
 Lampe chauffante infra-rouge, chromate
 Lámpara infrarrojos, cromado



GN 1/1 1/1 1/1

art.	dim. cm.	h.	V	W
49991-31	103x53	72	230	750



Lampada ad infrarossi con piano caldo
 Infrared lamp with warming plate
 Infrarot Wärmebrücke mit Tranchierplatte
 Lampe infra-rouge avec plaque chauffante
 Lámpara infrarrojos con placa caliente



GN 1/1

art.	dim. cm.	h.	V	W
49992-11	55x35	83	230	500+250



Lampada ad infrarossi con piano caldo
 Infrared lamp with warming plate
 Infrarot Wärmebrücke mit Tranchierplatte
 Lampe infra-rouge avec plaque chauffante
 Lámpara infrarrojos con placa caliente

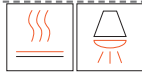

GN 1/1 1/1

art.	dim. cm.	h.	V	W
49992-21	70x55	83	230	500+500



Lampada ad infrarossi con piano caldo
 Infrared lamp with warming plate
 Infrarot Wärmebrücke mit Tranchierplatte
 Lampe infra-rouge avec plaque chauffante
 Lámpara infrarrojos con placa caliente

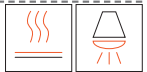

GN 1/1 1/1 1/1

art.	dim. cm.	h.	V	W
49992-31	103x55	83	230	1.500+750

Lampade ad accensione indipendente con pulsante luminoso. - Infrared lamps with independent lighting switch.



N

Lampada ad infrarossi con piano caldo
Infrared lamp with warming plate
Infrarot Wärmebrücke mit Tranchierplatte
Lampe infra-rouge avec plaque chauffante
Lámpara infrarrojos con placa caliente

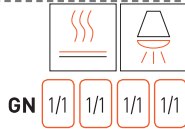

art.	dim. cm.	h.	V	W
49992-41	135x55	83	230	1.500+1.000



Macchina per gelato, inox
Ice cream maker, stainless steel
Eismaschine, Edelstahl Rostfrei
Machine à glace, inox
Maquinas helado, inox

art.	dim. cm.	h.	kg.	V	KW	lt.	prod.
49949-19	51x31	35	30	220	0,4	1,5	3kg/h



Disidratatore per frutta e verdura
Dehydrator for fruits and vegetables
Dehydratisierapparat
Déshydrateur fruits et légumes
Deshidratador de frutas y verduras

art.	dim. cm.	h.	kg.	V	KW
49953-02	43,5x29	21	3,6	220-240	0,53

Fornito con 6 vassoi reversibili. Temperatura regolabile da 30 a 80°C. Timer fino a 72 ore. Possibilità di utilizzare fino a 20 vassoi contemporaneamente. - Supplied with 6 reversible trays. Adjustable temperature range from 30 to 80 °C. Timer up to 72 hours. Use up to 20 trays at a time.



Affumicatoio a 2 piani, HELIA
Smoker, 2 levels
Räucherofen
Fumoir
Ahumador

art.	dim. cm.	h.	V	KW	kg.
49850-63	45x45	35	230	1,5	25

Dotazione: vassoio raccogli liquidi cm 30x40 e teglia, griglia pesce e griglia piana cm 30x40, 1kg di segatura di faggio, spezie per pesce, libro di ricette con istruzioni d'uso. - Equipment: drip tray cm 30x40 and smoking pan, trout grill and flat grill cm 30x40, 1kg of sawdust beech, fish spices, recipe book with direction of use.



N

Cutter, alluminio anodizzato
Cutter, anodized aluminum
Cutter, Aluminium eloxiert
Cutter, aluminium anodisé
Cutter, aluminio anodizado

art.	V	HP	kg.	lt.	dim. cm.	h.
49979-03	230	0,5	12	3	32x52	62

Dotazioni : lama universale. Lama sottile per tritare la carne. Lama con fori per impastare. - Equipped with: universal blade, thin blade to chop the meat and blade with holes for kneading.



N

Macchina per cialde
Waffle iron
Waffeleisen
Gufrier
Gofrera

art.	dim. cm.	h.	KW	kg.	output/h
49809-00	40x22	19	1,6	5,5	60

Per cialde perfettamente sagomate, divise in 4. Le piastre sono in acciaio inox satinato con doppio rivestimento antiaderente, possono essere utilizzate singolarmente. - Makes two rings of perfectly dimpled waffles, divided into 4 portions. Made from satin finish, top grade stainless steel, each plate has two layers of non-stick coating. The two hotplates can be operated individually.



Macchina per cialde, GESIMPLE
 Single waffle iron
 Waffeleisen mit 1 Platte
 Gaufrier simple
 Gofrera singular

art.	dim. cm.	h.	V	KW	kg.
49850-24	30,5x44	23	230	1,6	22
49850-25	30,5x44	23	230	1,6	22
49850-26	30,5x44	23	230	1,6	22
49850-27	30,5x44	23	230	1,6	22



Macchina per cialde doppia, GESDOUBLE
 Double waffle iron
 Waffeleisen mit 2 Platten
 Gaufrier double
 Gofrera doble

art.	dim. cm.	h.	V	KW	kg.
49850-28	55x44	23	230	3,2	38
49850-29	55x44	23	230	3,2	38
49850-30	55x44	23	230	3,2	38
49850-31	55x44	23	230	3,2	38



-24 / -28



-25 / -29



-26 / -30



-27 / -31



Macchina per cialde, GES23
 Single waffle iron
 Waffeleisen mit 1 Platte
 Gaufrier simple
 Gofrera singular



art.	dim. cm.	h.	V	KW	kg
49850-03	30,5x44	23	230	1,6	22



Combi mixer/frusta
Mixer/liquidiser combi unit
Kombigerät
Combiné mixeur-fouet
Braço triturador/batidor, unidad combinada

art.	rpm	max rpm	V	KW	B	C	F	kg.
49907-01	2000-9000	15000	230	0,35	36	43	36	4,95

Idoneo per la lavorazione in contenitori fino a 100 litri di capacità.
Suitable for food-processing in containers up to 100 liters capacity.

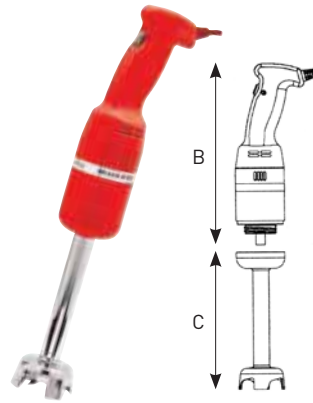

Mixer
Liquidiser
Stabmixer
Mixeur
Braço triturador

art.	rpm	V	KW	B	C	kg.
49907-06	15.000	230	0,25	28,5	27	1,45

Idoneo per la lavorazione in contenitori fino a 30 litri di capacità.
Suitable for food-processing in containers up to 30 liters capacity.



Supporto murale
Wall rack
Wandständer
Support mural
Soporte mural

art.
49907-AA



Supporto murale per art. 49907-06
Wall rack for item 49907-06
Wandständer für Art.-Nr. 49907-06
Support mural pour réf. 49907-06
Soporte mural para art. 49907-06

art.
49907-AB



Mixer
Liquidiser
Stabmixer
Mixeur
Braço triturador

art.	rpm	V	KW	kg.	h. cm
49807-00	0-13000	230	0,2	1	39,5

Fornito con 2 coltelli, 2 dischi e 1 misurino graduato. - Equipped with 2 knives, (chopper and star), 2 discs (beater and emulsion) and a graduated pot.



Mixer, per piccole preparazioni
Liquidiser, for small preparations
Stabmixer, für kleine Vorbereitungen
Mini mixer pour petites préparations
Braço triturador, para pequeñas preparaciones

art.	rpm	V	KW	kg.	h. cm
49808-00	12500-14000	220	0,45	0,82	40
49808-AC	frusta/whisk				
49808-AD	emulsionatore/emulsifier				



49911-24 49916-25 49916-35 49916-45 49916-55

Mixer
Liquidiser
Stabmixer
Mixeur
Braço triturador

art.	rpm	V	KW	kg.	lt.	h. cm
49911-24	2000>12500	230	0,27	1,4		24
49916-25	2300>9600	230	0,27	3,0	15	25
49916-35	2300>9600	230	0,35	3,3	45	35
49916-45	1500>9000	230	0,44	4,9	100	45
49916-55	9000	230	0,75	5,2	200	55



49911-19 49911-30 49911-35 49911-45

Combi mixer/frusta
Mixer/liquidiser combi unit
Kombigerät
Combiné mixeur-fouet
Braço triturador/batidor, unidad combinada

art.	rpm	V	KW	kg.	lt.	h. cm
49911-19	2000>12500 350>1560	230	0,25	1,9		19
49911-30	2300>9600 500>1800	230	0,30	3,1	30	30
49911-35	1500>9000 250>1500	230	0,44	5,9	50	35
49911-45	1500>9000 250>1500	230	0,50	6,1	100	45





Combinato cutter/frullatore ROBOT COOK
Cutter & blender
Gemüseschneid/- u. Mixermaschine
Cutter/Mixeur
Procesador de alimentos

art.	rpm	KW	kg.	dim. cm.	h.
49949-25	100-3500-4500	1,8	13,5	22,6x33,8	52,2

Velocità variabile da 100 a 3500 giri/min. Velocità Turbo 4500 giri/min. Migliore controllo delle preparazioni grazie al tasto Impulso Alta precisione. Lavora prodotti delicati senza tagliarli con la rotazione inversa dei coltelli: funzione R-Mix. 9 ricette programmabili. Robusto motore industriale asincrono. Dotato di un coltello a fondo vasca ad alta precisione. Potenza di riscaldamento modulabile fino a 140°, regolabile per grado. Un asciugacapelli anti-vapore. Un foro nel coperchio permette l'aggiunta d'ingredienti nella vasca senza dover interrompere la preparazione. Un sistema innovativo di blocco del coltello permette di svuotare la preparazione in tutta sicurezza. Tutti i pezzi a contatto con gli alimenti si smontano facilmente e sono lavabili in lavastoviglie. Il coperchio è a tenuta stagna e comprende una funzione di sicurezza. Potenza max. di riscaldamento 1200W, potenza motore 1000W, potenza nominale 1800W, 8 Amp. Capacità liquida L. 2,5. - Speed range from 100 to 3500 rpm. Turbo speed up to 4500 rpm. Better control of the preparations due to the key High precision Pulse. Prepares delicate products without cutting it thanks to the blade reverse rotation: R-Mix function. 9 programmable recipes. Asynchronous industrial motor, very robust. Equipped with high precision knife in the bottom tank. Heating power adjustable up to 140°, per single degree. Anti-steam cover dryer. A hole in the lid allows to add ingredients while working. An innovative lock knife system allows you to empty the preparation safely. All parts in contact with food can be easily dismantled and are dishwasher safe. The watertight lid includes a safety function. Max. heating power 1200W, motor power 1000W, rated power 1800W, 8 Amp. Liquid capacity L. 2,5.



Centrifuga J80 Ultra
Juice extractor
Fruchtpresse
Centrifugeur-presse agrumes
Centrifugadora/exprimidor jugos

art.	rpm	V	KW	kg.	dim. cm.	h.
49949-20	3000	230	0,7	11	23,5x42	50,5

Per la lavorazione di frutta e verdura. Dotata di vasca per la raccolta dei rifiuti con capacità 6,5 lt, una tramoggia automatica con ø79 mm che permette portate fino a 60kg/orari. Vasca in inox con beccuccio antigoccia. Motore industriale molto silenzioso che mantiene una velocità costante qualunque sia il carico. - Suitable for fruit and vegetables. Equipped with waste collector 6,5 lt, automatic hopper ø79 mm. Output up to 60kg/h. Stainless steel bowl with non drip spout. Very silent industrial motor, keeps constant speed regardless of the workload.



Tagliaverdure CL 50 Ultra
Vegetable preparation machine
Gemüseschneidmaschine
Coupe-légumes
Cortador verduras

art.	rpm	V	KW	kg.	dim. cm.	h.
49940-01	375	230	0,55	15	30x36	55,5

Corpo in acciaio inox, dotato di due alimentatori. Produzione max 300 coperti. Può cubettare da 5 a 25 mm. Ideale anche per il taglio della mozzarella. Per utilizzare la macchina vedere pag. 157 per i dischi di taglio - Stainless steel base with two sizes feed hoppers. Serving 300 covers max. Dicing from 5 to 25 mm. Suitable also for cutting mozzarella. To use the machine see page 157 for cutting discs.



Tagliaverdure CL 55
Vegetable preparation machine
Gemüseschneidmaschine
Coupe-légumes
Cortador de verduras

art.	rpm	V	KW	kg.	dim. cm.	h.
49940-03	375/750	400	1,1	27	38x30	84

Motore trifase. Base in acciaio inox. Tramoggia intercambiabile. Produzione max 600 coperti. Può cubettare da 5 a 25 mm. La macchina per le caratteristiche tecniche è ideale anche per il taglio della mozzarella. Per utilizzare la macchina, vedere pag. 157 per i dischi da taglio. - Three phase motor. Stainless steel base. Changeable hopper. Serving 600 covers max. Dicing from 5 to 25 mm. Suitable for the mozzarella cheese cutting too. To use the machine, see page 157 for cutting discs.



Tagliaverdure CL 52
Vegetable preparation machine
Gemüseschneidmaschine
Coupe-légumes
Cortador verduras

art.	rpm	V	KW	kg.	dim. cm.	h.
49940-02	375	400	0,75	21	30x36	64

Motore trifase. Versione da banco base in acciaio inox. Produzione max 500 coperti. Può cubettare da 5 a 25 mm. Modello ideale per lavorare tutte le verdure voluminose come cavoli e melanzane. Per utilizzare la macchina, vedere pag. 157 per i dischi da taglio. - Three phase motor. Table-top model, stainless steel base. Serving 500 covers max. Dicing from 5 to 25 mm. Ideal model to cut all the big vegetables as cabbage and aubergine. To use the machine, see page 157 for cutting discs.



Combinato cutter/tagliaverdure R301 Ultra
Cutter & vegetable slicer
Gemüseschneid/- u. Schälmaschine
Cutter/Coupe-légumes
Cortador verduras

art.	rpm	V	KW	kg.	dim. cm.	h.
49942-01	1500	230	0,65	14	28,5x36	40

Comando ad impulsi. Vasca smontabile inox da 3,7 litri. Produzione max 70 coperti. Dotazione gruppo tagliaverdure in ABS, coltelli lisci. Possibilità di affettare, sfilacciare, listellare, grattuggiare, granulare, non può cubettare. Dischi da taglio vedere pag. 157. - Equipped with a pulse control for optimum cutting precision. Stainless steel bowl of 3,7 lt easy to dismantle. Serving 70 covers max. Equipped with a set of ABS slicers, straight knives. Suitable for slicing, scalop cutting, julienne ripple cut slicing and grating, not for dicing. Cutting discs see page 157.



Combinato cutter/tagliaverdure R502
Cutter & vegetable slicer
Gemüseschneid/- u. Schälmaschine
Cutter/Coupe-légumes
Cortador verduras

art.	rpm	V	KW	kg.	dim. cm.	h.
49942-02	750/1500	400	1	30	35,5x30	65,5

Motore trifase. Comando ad impulsi. Vasca smontabile inox da 5,5 litri con coperchio a tenuta liquidi. Produzione max 300 coperti. Dotazione gruppo tagliaverdure in alluminio, coltelli lisci. Può cubettare da 5 a 25 mm. Dischi da taglio vedere pag. 157. - Three phase motor. Equipped with pulse control. Stainless steel bowl of 5,5 lt easy to dismantle. Serving 300 covers max. Vegetable cutting unit in aluminum. Including a straight blade knife. Dicing from 5 to 25 mm. Cutting discs see page 157.



Combinato cutter/tagliaverdure R502 VV
Cutter & vegetable slicer
Gemüseschneid/- u. Schälmaschine
Cutter/Coupe-légumes
Cortador verduras

art.	rpm	V	KW	kg.	dim. cm.	h.
49942-03	300x3500	230	1,3	30	35,5x30	65,5

Vasca smontabile inox da 5,5 litri con coperchio a tenuta liquidi. Produzione max 300 coperti. Dotazione gruppo tagliaverdure in alluminio, coltelli lisci. Può cubettare da 5 a 25 mm. Dischi da taglio vedere pag. 157. - Equipped with pulse control. Stainless steel bowl of 5,5 lt easy to dismantle. Serving 300 covers max. Vegetable cutting unit in aluminum. Including a straight blade knife. Dicing from 5 to 25 mm. Cutting discs see page 157.



Cutter da tavolo R4
Table-top cutter
Gemüseschneidmaschine
Cutter à légumes
Cortador verduras

art.	rpm	V	KW	kg.	dim. cm.	h.
49943-01	1500/3000	400	0,9	17	21x32	43

Motore trifase. Comando ad impulsi. Vasca smontabile inox da 4,5 litri. Corpo in pressofusione. Dotazione coltelli lisci. Disponibili su richiesta coltelli dentati e coltelli dentati fini. - Three phase motor. Equipped with pulse control. Stainless steel bowl of 4,5 lt. Diecast aluminum body. Including a straight blade knife. Available on demand serrated and slightly serrated blade knives.



Cutter da tavolo R5 plus
Table-top cutter
Gemüseschneidmaschine
Cutter à légumes
Cortador verduras

art.	rpm	V	KW	kg.	dim. cm.	h.
49943-02	1500/3000	400	1,2	24	28x34	48

Motore trifase. Comando ad impulsi. Vasca smontabile inox da 5,5 litri con coperchio a tenuta di liquidi. Corpo in pressofusione. Dotazione coltelli lisci. Disponibili su richiesta coltelli dentati. - Three phase motor. Equipped with pulse control. Stainless steel bowl of 5,5 lt. Automatic bowl locking. Diecast aluminum body. Including a straight blade knife. Available on demand serrated blade knife.



Omogeneizzatore Blixer 4
Emulsifier-mixer
Mixergerät
Emulsionneur-mixer
Omogenizador/emulsificador

art.	rpm	V	KW	kg.	dim. cm.	h.
49944-01	1500/3000	400	1	18	46x22,5	30,5

Motore trifase. Comando ad impulsi. Vasca smontabile inox da 4,5 litri e capacità liquidi massima di 2,5 litri. Dotazione contropala raschiatrice, coltelli a tenuta di liquidi con speciale dentatura. Corpo in pressofusione. Three phase motor. Equipped with pulse control. Stainless steel bowl of 4,5 lt. Maximum liquid capacity 2,5 lt. Including a scraper arm and special serrated blade knife. Diecast aluminum body.



Omogeneizzatore Blixer 4 VV
Emulsifier-mixer
Mixergerät
Emulsionneur-mixer
Omogenizador/emulsificador

art.	rpm	V	KW	kg.	dim. cm.	h.
49944-02	300x3500	230	1,1	18	46x22,5	30,5

Comando ad impulsi. Vasca smontabile inox da 4,5 litri e capacità liquidi massima di 2,5 litri. Corpo macchina in pressofusione. Dotazione contropala raschiatrice, coltelli a tenuta di liquidi con speciale dentatura. Equipped with pulse control. Stainless steel bowl of 4,5 lt. Maximum liquid capacity 2,5 lt. Including a scraper arm and a special serrated blade knife. Diecast aluminum body.







Centrifuga C80
Sieving juicer
Passiermaschine
Centrifugeuse
Centrifugadora

art.	rpm	V	KW	kg.	dim. cm.	h.
49946-01	1500	230	0,65	21	61x36	54

Produzione 50 kg/ora. Versione da banco. Dotazione cestello setaccio fori ø1 mm, disponibili su richiesta cestello setaccio con fori ø0,5 e ø3 mm. Hourly output: 50 kg. Table-top model. Including a standard ø1 mm sieve, available on demand sieves ø0,5 and ø3 mm.



	49941 R 301 Ultra	49940 R 502 / R 502 V.V. CL 50 Ultra CL 52 / CL 55
	Dischi Discs	
0,8 mm		AA
1 mm	AA	AB
2 mm	AB	AC
3 mm	AC	AD
4 mm	AD	AE
5 mm	AE	AF
6 mm	AF	
8 mm		AG
10 mm		AH
14 mm		AI
	2 mm	AG
3 mm		AM
5 mm		AN
	1,5 mm	AH
2 mm	AI	AP
3 mm	AL	AQ
4 mm		AR
5 mm		AS
6 mm	AM	
7 mm		AT
9 mm Rösti	AN	AU
Parmesan	AO	AV
Raifort 0,7 mm	AP	
Raifort 1,0 mm	AQ	AZ
Raifort 1,3 mm	AR	
	2x2 mm	AS
2x4 mm	AT	BA
2x8 mm	AU	BC
3x3 mm		BD
4x4 mm	AV	BE
6x6 mm	AZ	BF
8x8 mm	AY	BG
	5x5x5 mm	● BM
8x8x8 mm		● BN
10x10x10 mm		● BO
14x14x5 mm		● BL
14x14x14 mm		● BP
20x20x20 mm		● BQ
25x25x25 mm		● BR
	8x8 mm	○ BH (1)
10x10 mm	French Fries	○ BI (1)

● Kit Cubetti: 1 griglia + 1 disco taglio. - Dices: 1 grid + 1 cutting disc.
○ Kit Patatine: 1 griglia + 1 disco speciale. - French fries: 1 grid + 1 special cutting disc.
(1) Non disponibile per CL 55 a leva. - Not available for CL 55 lever.



Spremiagrumi
Citrus fruit squeezer
Zitruspresse
Presse agrumes
Exprimidor cítricos

art.	rpm	V	KW	kg.	dim. cm.	h.
49922-01	1500	220-240	0,13	5	20x30	35

Base in lega di alluminio, ogiva in policarbonato. Facile da pulire, ogiva, contenitore, griglia e filtro estraibili in un semplice movimento. Base unipiece (blocco motore). Vassoio raccogli gocce in plastica, estraibile, 3 coni di spremitura (lime, limoni/arance, pompelmi). Altezza del becco 125 mm. Blocco motore resistente all'acqua. Elevata stabilità.

Aluminum alloy base and polycarbonate bowl. The whole bowl assembly including bowl, pips, filter grid and squeezer, can easily be taken out from the base in a simple movement. One piece base (motor block). Removable plastic drip tray, 3 removable squeezers (limes, lemons and oranges, grapefruits). Height of the spout 125 mm. Waterproof motor block. High stability.



Spremiagrumi
Citrus fruit squeezer
Zitruspresse
Presse agrumes
Exprimidor cítricos

art.	rpm	V	KW	kg.	dim. cm.	h.
49922-02	1500-1800	220-240	0,23	10	20,5x30,5	49

In alluminio pressofuso e acciaio inox. Ogiva e griglia filtro in acciaio inox. Particolarmente adatto per produzione continua. Facile da pulire: rapida rimozione dell'ogiva, griglia del filtro, cupola e spremiagrumi. 3 coni di spremitura (lime, limoni/arance, pompelmi). Cupola in policarbonato nero anti-spruzzi. Corpo inclinato per un migliore rendimento. Altezza del becco 212 mm. Produzione massima, circa 200 arance/h, 20 litri/h. Tutte le parti rimovibili sono lavabili in lavastoviglie.

Aluminum casting and stainless steel construction. Stainless steel bowl and filter grid. Particularly adapted for continuous production. Easy to clean: quick removal of the bowl, filter grid, dome and squeezer. 3 removable squeezers (limes, lemons and oranges, grapefruits). Black polycarbonate anti-splash dome. Inclined body for a better output. Height of the spout 212 mm. Maximum output approximately 200 oranges/hour, 20 liters/hour. All removable parts are dishwasher safe.



Spremiagrumi
Citrus fruit squeezer
Zitruspresse
Presse agrumes
Exprimidor cítricos

art.	rpm	V	KW	kg.	dim. cm.	h.
49922-03	1500-1800	220-240	0,23	10	20x30	38

In alluminio pressofuso e acciaio inox. Per arance, limoni e pompelmi. Basta tagliare la frutta in 2 parti e spremere. Estrae il massimo di succo per azione centrifuga. Leva start e stop. Tutte le parti a contatto con la frutta sono in inox. Facile da pulire. Rimozione rapida del filtro. Tutte le parti rimovibili sono lavabili in lavastoviglie. - Aluminum casting and stainless steel construction. For oranges, lemons and grapefruits. Just cut the fruit into 2 parts and squeeze. Extracts the maximum of juice by centrifugal action. Lever action start and stop. All parts in contact with fruit are stainless steel. Easy to clean. Quick removal of the perforated strainer. All removable parts are dishwasher safe.



Spremiagrumi
Citrus fruit squeezer
Zitruspresse
Presse agrumes
Exprimidor cítricos

art.	rpm	V	KW	kg.	dim. cm.	h.
49922-04	1500-1800	220-240	0,275	10	24x40	49



Centrifuga, spremisucchi
Juice extractor
Fruchtpresse
Centrifugeur-presse agrumes
Centrifugadora/exprimidor jugos

art.	rpm	V	KW	kg.	dim. cm.	h.
49922-06	3000-3300	220-240	0,8	16	26x47	45

Paniere di filtraggio con fori $\varnothing 0,5$ mm. Produzione continuata per azione centrifuga ed espulsione automatica della polpa. Altezza del becco 200 mm. Ad alto rendimento, più di 1 litro/minuto. Foro di carico circolare ($\varnothing 79$ mm). Non è necessario tagliare frutta e verdura. Struttura in acciaio inox. Sistema brevettato di bloccaggio-sbloccaggio con leva speciale. Tutte le parti rimovibili sono lavabili in lavastoviglie. - Standard basket is provided with $\varnothing 0,5$ mm holes. Continuous juice production by centrifugal action and automatic pulp ejection. Height of the spout 200 mm. High output more than 1 liter/minute. Wide circular feeding hole ($\varnothing 79$ mm.) no need to cut fruits or vegetables. Stainless steel bowl and base. Patented locking-unlocking system with special lever. Motor braking when opening. All removable parts are dishwasher safe.



Centrifuga, spremisucchi
Juice extractor
Fruchtpresse
Centrifugeur-presse agrumes
Centrifugadora/exprimidor jugos

art.	rpm	V	KW	kg.	dim. cm.	h.
49949-14	3000-3600	220-240	1,3	25	33x56,2	60,6

Tutte le parti a contatto con gli alimenti sono completamente in acciaio inox. Sistema brevettato Ezy-clean System II (coperchio, ciotola e cesto facilmente removibili). Non è necessario pre-tagliare frutta e verdura. Foro di carico circolare ($\varnothing 79,5$ mm). Resa 140 litri/h. Full stainless steel food zone, no aluminum, no plastic. Patented Ezy-clean System II (cover, bowl and basket are easily removable thanks to their new ergonomics). No pre-cutting needed, wide feeding chute $\varnothing 79,5$ mm. Extremely sturdy, no plastic in the shifter area, all in metal. Output up to 140l/h.



Spaccaghiaccio
Ice crusher
Eiszerstosser
Broyeur à glace
Triturador de hielo

art.	rpm	V	KW	kg.	dim. cm.	h.
49922-08	73-89	220-240	0,13	10	24x35	47

Dotato di sicurezza elettrica, termica e meccanica. 2 misure di tritatura. Funzionamento sia manuale che automatico (timer). Base in robusto ABS, alta stabilità. Capacità massima della tramoggia 1,3 kg. Produzione massima 160 fino a 300kg/h. circa. Illuminazione del ghiaccio tritato. Tutte le parti rimovibili sono lavabili in lavastoviglie. Electrical, thermal and mechanical safety. Choose coarse or fine ice, electronic control unit. Both manual and automatic (timer). Heavy duty ABS base - high stability. Ice basket max. capacity 1,3 kg. Maximum output approximately 160 to 300kg/hour. Crushed ice lighting. All removable parts are dishwasher safe.



Frullino
Mixer
Quirl
Batteur
Mixer

art.	rpm	V	KW	kg.	dim. cm.	h.
49949-09	8000-16000	220-240	0,12	6	18x18	53

Corpo in alluminio pressofuso e acciaio inox. 2 bicchieri in acciaio inox e policarbonato capacità = 675 ml. Agitatori facilmente smontabili, avvitando e svitando il mandrino. Tutte le parti rimovibili sono lavabili in lavastoviglie. - Aluminum casting and stainless steel construction. Stainless steel bowl and polycarbonate bowl capacity = 0,675 lt. Easy removable agitators (tools) by simple screwing/unscrewing on the spindle. All removable parts are dishwasher safe.



Frullatore
Blender
Mixer
Mixeur
Mixer

Frullatore
Blender
Mixer
Mixeur
Mixer



art.	rpm	V	KW	kg.	dim. cm.	h.	lt.
49922-22	500-15000	220-240	1,2	11	30x22	56,6	2
49922-23	500-15000	220-240	1,2	11	30x22	56,6	4

art.	rpm	V	KW	kg.	dim. cm.	h.	lt.
49922-20	500-15000	220-240	1,2	11	30x22	56,6	2
49922-21	500-15000	220-240	1,2	11	30x22	56,6	4

Ideale per alberghi, bar, ristoranti, self-service, ospedali... Per miscelare, liquefare, emulsionare... tutti i tipi di alimenti e bevande. Trita rapidamente cubetti di ghiaccio. Velocità controllata da un processore elettronico che previene anche il surriscaldamento o il blocco dell'asse. Il contenitore può essere collocato in qualsiasi posizione. Lame in acciaio inox temperato. Sistema di bloccaggio-sbloccaggio con leva speciale brevettato. Tutte le parti rimovibili possono essere lavate in lavastoviglie. - Heavy duty appliance for hotels, bars, restaurants, cafeterias, hospitals... For blending, mixing, liquefying, emulsifying... all types of preparations of food and drink. Quickly crushes ice cubes. Speed is controlled by an electronic processor. This module also prevents overheating or blocking of the axle. Completely safe: locking system for bowl and lid. The container can be placed in any position. High duty tempered stainless steel blades and drive shaft parts, easy to dismount without tool. Patented locking-unlocking system with special lever. All removable parts are dishwasher safe.



Frullatore
Blender
Mixer
Mixeur
Batidora de vaso



art.	V	KW	kg.	dim. cm.	h.
49922-09	220-240	3	9	20x47	44

Blender ideale per la preparazione di qualsiasi tipo di cocktail, frullati, succhi di frutta, frappe, granite, caffè freddo, ecc., grazie alle sue 30 ricette pre-programmate. Per cubetti di ghiaccio, frutta, con o senza liquidi. Tutte le parti rimovibili possono essere lavate in lavastoviglie. Bicchiere senza BPA.

Blender for any kind of cocktails, smoothies, fruit juices, milkshakes, granitas, iced coffee, frappe, etc., thanks to its 30 pre-programmed recipes. Ergonomic sensitive glass control panel. For ice cubes, fruits, with or without liquid. All removable parts can be put in dishwasher or easily cleaned with hot soapy water. BPA-free jar.



Grattugia formaggio
Cheese grater
Käse-Raffelmaschine
Râpeur à fromage
Ralladora para queso

art.	rpm	V	KW	kg.	dim. cm.	h.
49922-14	1500-1800	220-240	0,6	14	25x42	35

Per formaggio, cioccolato, frutta secca, noccioline... Fornito con 1 disco standard per Gruyère con fori \varnothing 3 mm. Su richiesta dischi con fori: \varnothing 2, 4, 6, 8 mm. Corpo in alluminio pressofuso e acciaio verniciato. Produzione media 50 kg/h. Dotato di uno speciale contenitore in plastica (cassetto). Capacità 800 g. - For Cheese, chocolate, dried fruits, peanuts... Provided with 1 standard disc for Gruyère with \varnothing 3 mm holes. On request: \varnothing 2, 4, 6, 8 mm holes discs. Aluminum casting and painted steel housing. Average output 50 kg/hour. Provided with a special plastic container (drawer). Capacity 800 g. Capacity 800 g.



Spremiagrumi
 Citrus fruit squeezer
 Zitruspresse mit Spritzschutz
 Presse agrumes
 Exprimidora

art.	rpm	V	KW	kg.	dim. cm.	h.
49958-00	1400	230	0,3	8	31x22	34

Recipiente in acciaio inox. Ogiva unificata per arance, limoni, pompelmi.
 Stainless steel container. Universal shape for oranges, lemons, grapefruits.



Spremiagrumi a leva
 Lever citrus fruit squeezer
 Zitruspresse mit Pressarm
 Presse agrumes à levier
 Exprimidora

art.	rpm	V	KW	kg.	dim. cm.	h.
49959-00	1400	230	0,34	9	31x22	35

Messa in moto automatica a pressione. Apparato di spremitura in acciaio inox. Diametro filtro rotante: 110 mm. - Pressure sensitive automatic starter. Stainless steel squeezing set. Diameter of rotating filter: 110 mm.



Frullatore
 Blender
 Getränkemixer
 Mixeur
 Mixer

art.	rpm	V	KW	kg.	dim. cm.	h.
49956-01	10000>15000	230	400	4	20x20	46

Capacità bicchiere plastica 1,7 lt. Disponibile ricambio bicchiere plastica 1,7 lt art. 49956-AA oppure in inox art. 49956-AB.
 Plastic glass capacity 1,7 lt. Available spare plastic glass item 49956-AA or in stainless steel item 49956-AB.



Frullatore
 Blender
 Getränkemixer
 Mixeur
 Mixer

art.	rpm	V	KW	kg.	dim. cm.	h.
49957-00	12000>22000	230	1	5,5	23x23	52

Capacità bicchiere inox 3 lt. - Stainless steel glass capacity 3 lt.



Tritaghiaccio automatico
 Automatic ice crusher
 Eiszerstosser
 Broyeur à glace
 Triturador de hielo automatico

art.	rpm	V	KW	kg.	dim. cm.	h.
49960-00	1400	230	0,34	11	42x21	29



Frullino
 Drink Mixer
 Getränkemixer
 Shaker électrique
 Batidora para batidos

art.	rpm	V	KW	kg.	dim. cm.	h.
49955-01	15000	230	0,12	2,8	20x22	50

Capacità bicchiere plastica 0,8 lt. Disponibile ricambio bicchiere plastica 0,8 lt. art. 49955-AA oppure in inox art. 49955-AB.
 Plastic glass capacity 0,8 lt. Available spare plastic glass item 49955-AA or in stainless steel item 49955-AB.



Cuoci riso a vapore
Rice steamer
Reiskocher
Cuit riz
Hervidor de arroz

art.	ø cm.	h.	lt.	V	KW	Kg riso/rice
49954-21	50	35	21	220	3	10



Vaporiera, inox
Steamer, stainless steel
Dampfer, Edelstahl Rostfrei
Cuit vapeur, inox
Olla para cocinar al vapor, inox

art.	ø cm.	h.	kg.	V	KW	lt.
49954-18	38	46	7	230	2	15



Impastatrice planetaria
Planetary mixer
Knet- u. Schlagmaschine
Batteur-mélangeur
Batodira planetaria

art.	rpm	V	KW	kg.	dim. cm.	h.
49947-08	1420	230	0,18	27	30x40	58

3 velocità planetaria 135-235-421 giri/min. Capacità vasca 7,6 lt. Timer 0-15 min. - 3 planetary speeds: 135-235-421 rpm. Bowl capacity 7,6 lt. Timer 0-15 min.

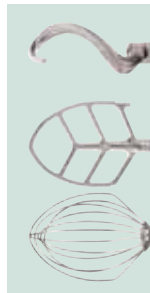

Tutti i modelli sono dotati di un selettore meccanico di velocità sulla parte superiore della macchina. Pos. 1-3 uncino - Pos. 4-7 spatola - Pos. 7-10 frusta. All models are equipped with a mechanical speed selector on the top of the machine. Pos. 1-3 hook - Pos. 4-7 spatula - Pos. 7-10 whip.



Impastatrice planetaria
Kitchen planetary mixer
Knet-u. Schlagmaschine
Batteur mélangeur
Batidora mezcladora

art.	rpm	V	KW	kg.	dim. cm.	h.
49945-05	40x260	230	0,75	15	38x31	45,5

10 velocità. Capacità vasca 5 lt. - 10 speeds. Bowl capacity 5 lt.



Forno microonde, inox PROG
Microwave oven, stainless steel
Mikrowelle, Edelstahl Rostfrei
Four à micro-ondes, inox
Microonda, inox

art.	dim. cm.	h.	V	KW	kg.	lt.
49997-12	54,2x46,1	32,9	230	1,6	18	30

5 livelli di potenza, da 200 a 1000W. Fondo fisso in vetroceramica GN2/3. Tasto raddoppiamento tempo X2. Timer digitale sul display. 3 stadi cottura e 5 livelli di potenza. 10 tasti programmabili. 20 programmi. 5 power levels, from 200 to 1000W. Fixed glass ceramic bottom GN2/3. Key doubling time X2. Digital timer on the display. 3 cooking stages, 5 power levels. 10 programmable keys. 20 programs.



Forno microonde, inox SELF
Microwave oven, stainless steel
Mikrowelle, Edelstahl Rostfrei
Four à micro-ondes, inox
Microonda, inox

art.	dim. cm.	h.	V	KW	kg.	lt.
49997-13	54,2x46,1	32,9	230	1,6	18	30

Particolarmente indicato per l'impiego nelle aree self-service. Fondo fisso in vetroceramica GN2/3. Tasto raddoppiamento tempo X2. Timer digitale sul display. Tasto "START" pre-programmato "1 minuto" a piena potenza. Parametri pre-impostati personalizzabili. - The electronic single control makes it particularly suitable for the use in self-service areas. Fixed glass ceramic bottom GN2/3. Key doubling time X2. Digital timer on the display. "START" button preprogrammed "1 minute" at full power. Parameters customizable.



KIT TERMOMETRO PER SOTTOVUOTO
Sous vide cooking thermometer kit
PAGINA - Page: 108



Apparecchio per cottura sottovuoto
Sous-vide cooking device
Sous-Vide Garer
Cuisseur bain marie - sous vide
Equipo para cocinar al vacío

Per cuocere gli alimenti a bagnomaria in buste sottovuoto. La temperatura è mantenuta precisamente costante e può essere regolata da 30°C a 100°C.
This appliance cooks food in vacuum-sealed pouches submerged in a water bath held at a precisely-controlled temperature from 30°C to 100°C.

art.	dim. cm.	h.	lt.	Kg	V	KW	Hz
49954-22	36x29,2	29	11	5,9	220-240	0,715-0,850	50-60



Apparecchio per cottura sottovuoto
Soft cooker
Sous-Vide-Garer
Thermoplongeur
Máquina para cocinar al vacío

Involucro completamente in acciaio inox, altezza minima del recipiente 167 mm, controllo elettronico della temperatura con precisione al 1/10°C (controllo a treno d'impulsi), temperatura regolabile da 0 a 99,9°C. Termostato di sicurezza, galleggiante di sicurezza per controllo acqua, altezza minima immersione resistenza 10 cm. Ideale per recipienti fino a 50 litri.

Case completely made of stainless steel, min. height of the tank 167 mm, electronic temperature control with 1/10°C precision (pulse train control), adjustable temperature from 0 up to 99,9°C, safety thermostat, waterline safety float, min. heating element immersion height 10 cm. Suitable for containers up to 50 liters.

art.	dim. cm.	h.	V	KW	Kg
49851-10	16,4x22	22	230	0,2	7

Corpo in ABS. Doppia pompa autolubrificata, non necessita di manutenzione. 800 mbar c.ca. Controllo elettronico. Motore con arresto automatico in caso di surriscaldamento. RPM 2900 max. Capacità d'aspirazione 22 litri/min. - ABS body. Self-lubricated double pump, no maintenance. 800 mbar about. Electronic control. Motor with automatic shutdown in case of overheating. 2900 RPM max. Suction capacity: 22 litres/min.



Macchina sottovuoto
Vacuum machine
Vakuumiergerät
Machine pour l'emballage sous-vide
Máquina para el envasado al vacío

Sacchetti gofrati
Embossed vacuum bags
Geprägte Vakuum-Beutel
Sacs gauffrés pour sous vide
Bolsas gofradas para vacío

Poliammide (PA - assicura l'impermeabilità) polietilene (PE garantisce la qualità della striscia di sigillatura). - Polyamide (PA - ensures impermeability) Polyethylene (PE ensures quality of the sealed strip).

art.	dim. cm.	h.	kg.	V	W
49952-00	38,5x23,5	9,5	3,7	230	240

art.	dim. cm.	pcs
49952-AA	28x35	25
49952-AB	13x55	30
49952-AC	28x20	40



N

Piastra ad induzione
Induction cooker
Induktionsplatte
Plaque à induction
Placa de inducción

art.	dim. cm.	h.	V	KW	kg.
49998-10	35,5x44	12	220-240	3,5	6,5

Superficie in Schott Ceran. Corpo in acciaio inox. Funzioni sensitive-touch. Timer 0-180 minuti. 10 livelli di potenza. Funzione timer. Rilevamento automatico della misura della pentola. Temperatura da 60 a 240°C. Schott ceran surface. Stainless steel body. Sensitive-touch functions. Timer 0-180 min. 10 power levels. Timer function. Automatic measuring of pot size. Temperature range 60°C-240°C.



Piastra ad induzione
Induction cooker
Induktionsplatte
Plaque à induction
Placa de inducción

art.	dim. cm.	h.	V	KW	kg.
58162-RA	30X37	10	220-240	0,5-2,7	6

Corpo inox, piano in vetroceramica Schott, display a led, timer 0-180 minuti, 1-10 livelli di potenza, temperatura 60-240°C. Stainless steel body, Schott ceran hob, led display, timer (0-180 min.), 1-10 power levels, temperature range 60°C-240°C.



Piastra ad induzione, da incasso
Induction cooker, to be built into counter
Induktionsplatte, thekeneinbau
Plaque à induction, montage an comptoir
Placa de inducción para emportar

art.	dim. cm.	h.	V	KW	kg.
58162-RB	36X38	12,5	220-240	0,5-3,5	5,7

Piano in vetroceramica Schott, timer 0-180 minuti, 1-10 livelli di potenza, temperatura 60-240°C. - Schott ceran hob, timer (0-180 min.), 1-10 power levels, temperature range 60°C-240°C.



Piastra ad induzione, da incasso
Induction cooker, to be built into counter
Induktionsplatte, thekeneinbau
Plaque à induction, montage an comptoir
Placa de inducción para emportar

art.	dim. cm.	h.	V	KW
49998-20	35,5x35,5	6	230	2

5 livelli di potenza, selezione temperatura da 60 a 240°C, piano in vetroceramica Schott. - Digital heat setting by 5 power levels, temperature range from 60 to 240°C. Schott ceramic glass.

Tubi UV actinici a lunga durata (1 anno). Cavo d'alimentazione mt 1,20. 230 Volts, 50-60 Hz. Griglia interna ad alta tensione e griglia di protezione in filo inox. Vaschetta recupero inox. - UV actinic tube, long lasting (1 year). Cable lenght 1,20 m. 230 Volts, 50-60 Hz. Internal high-voltage grid and grid protection in stainless steel wire. Stainless steel recovery tank.



N

Adattatore induzione
Induction adapter
Induktion Adapterplatte
Disque relais pour induction
Adaptador para inducción

art.	Ø cm.
41922-16	16
41922-22	22



Sterminatore elettrico, inox
Electric insect killer, stainless steel
Insektenvernichter, Edelstahl Rostfrei
Désinsectiseur électrique, inox
Exterminador de insectos, inox

art.	dim. cm.	h.	W	m ²	
49791-50	61,5x14,2	28,5	40	50	murale/wall mounting
49792-09	61,5x11	33,0	2x20	90	sospeso/cealing mounting

PIZZA E PANE *PIZZA & BREAD*



UTENSILI KITCHEN UTENSILS



Oliera, inox
Oil pourer, stainless steel
Ölkanne, Edelstahl Rostfrei
Huilière, inox
Alcuza, inox

art.	lt.
41780-07	0,75
41780-10	1,00
41780-20	2,00



Oliera, inox
Oil pourer, stainless steel
Ölkanne, Edelstahl Rostfrei
Huilière, inox
Alcuza, inox

art.	lt.
41780-05	0,45
41780-09	0,90



Oliera, rame
Oil pourer, copper
Ölkanne, Kupfer
Huilière, cuivre
Alcuza, cobre

art.	lt.	h. cm
41781-05	0,5	23
41781-10	1,0	27

Interno stagnato. - Tinned inside.



Oliera, rame
Oil pourer, copper
Ölkanne, Kupfer
Huilière, cuivre
Alcuza, cobre

art.	lt.	h. cm
41781-15	1,5	31,5

Interno stagnato. - Tinned inside.



Pala pizza, alluminio
Pizza peel, aluminum
Pizzaschaufel, Aluminum
Pelle à pizza, aluminum
Pala pizza, aluminio

art.	ø cm.	l.	gr.
11701-02	32	150	736
11701-06	37	150	870
11701-10	41	150	1226
11701-13	45	150	1460
11701-16	50	150	1604



Pala pizza, alluminio
Pizza peel, aluminum
Pizzaschaufel, Aluminum
Pelle à pizza, aluminum
Pala pizza, aluminio

art.	dim. cm.	l.	gr.
11702-02	32x32	150	784
11702-06	37x37	150	894
11702-10	41x41	150	1246
11702-16	50x50	150	1694

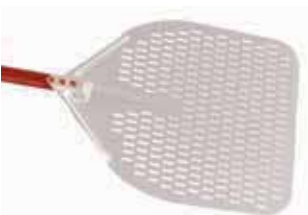

Pala pizza forata, alluminio
Perforated pizza peel, aluminum
Pizzaschaufel, gelocht, Aluminum
Pelle à pizza perforée, aluminum
Pala pizza perforada, aluminio

art.	dim. cm.	l.	gr.
11704-02	32x32	150	700
11704-06	37x37	150	816
11704-13	45x45	150	1250
11704-16	50x50	150	1409



Palettino, inox
Pizza peel, small, stainless steel
Pizzaschaufel, klein, Edelstahl Rostfrei
Petite pelle à pizza, inox
Pala pizza, pequeña, inox

art.	ø cm.	l.	gr.
11705-02	17	150	780
11705-06	20	150	846
11705-10	23	150	938
11705-14	26	150	984



Palettino forato, inox
Perforated pizza peel, small, s/s
Pizzaschaufel, gelocht, klein, Edelstahl
Petite pelle à pizza perforée, inox
Pala pizza perforada, pequeña, inox

art.	ø cm.	l.	gr.
11706-02	17	150	770
11706-06	20	150	830
11706-10	23	150	912
11706-14	26	150	954



Pala per infornare, alluminio
Oven pizza peel, aluminum
Back-Pizzaschaufel, Aluminum
Pelle à enfourner, aluminum
Pala para hornear, aluminio

art.	dim. cm.	l.	gr.
41765-32	32x32	150	1200
41765-37	37x37	150	1400
41765-41	41x41	150	1500
41765-45	45x45	150	1600
41765-50	50x50	150	1700



Pala per infornare, inox
Oven pizza peel, stainless steel
Back-Pizzaschaufel, Edelstahl
Pelle à enfourner, inox
Pala para hornear, inox

art.	ø cm.	l.	gr.
41735-29	29	150	870

Manico alluminio. - Aluminum handle.



Pala per infornare, alluminio
Oven pizza peel, aluminum
Back-Pizzaschaufel, Aluminum
Pelle à enfourner, aluminum
Pala para hornear, aluminio

art.	dim. cm.	l.	gr.
41736-32	32x30	150	954



Palettino forato, inox
Perforated pizza peel, small, s/s
Pizzaschaufel, gelocht, klein, Edelstahl
Petite pelle à pizza perforée, inox
Pala pizza perforada, pequeña, inox

art.	ø cm.	l.	gr.
41737-17	17	150	890
41737-20	20	150	910
41737-23	23	150	960



Palettino, inox
Pizza peel, small, stainless steel
Pizzaschaufel, klein, Edelstahl Rostfrei
Petite pelle à pizza, inox
Pala pizza, pequeña, inox

art.	ø cm.	l.	gr.
41738-17	17	150	905
41738-20	20	150	975
41738-23	23	150	1030



Palettino, alluminio
Pizza peel, small, aluminum
Pizzaschaufel, klein, Aluminum
Petite pelle à pizza, aluminum
Pala pizza, pequeña, aluminio

art.	ø cm.	l.	gr.
41735-20	20	150	800

Manico zincato. - Galvanized handle.



Pala pizza, legno
Pizza peel, wood
Pizzaschaufel, Holz
Pelle à enfourner, bois
Pala pizza, madera

art.	ø cm.	l.
41764-28	28	125
41764-33	33	200
41764-40	40	200



Paletta cenere, inox
Ash shovel, stainless steel
Asche-Schaufe, Edelstahl Rostfrei
Pelle à cendres, inox
Paleta recogedar cenizas, inox

art.	dim. cm.	l.
41768-21	21x31	173



Rastrello, inox
Rake, stainless steel
Harke, Edelstahl Rostfrei
Râteau, inox
Rastrillo, inox

art.	dim. cm.	l.
41768-22	24x10	150



Spazzola orientabile
Adjustable brush
Drehbare Bürste
Brosse orientable
Cepillo orientable

art.	dim. cm.	l.
41767-20	20x6,5	155

Setole ottone. - Brass bristles.



Spazzola orientabile
Adjustable brush
Drehbare Bürste
Brosse orientable
Cepillo orientable

art.	dim. cm.	l.
41766-27	27x7	150

Setole ottone. - Brass bristles.



Spazzola orientabile
Adjustable brush
Drehbare Bürste
Brosse orientable
Cepillo orientable

art.	dim. cm.	l.
41766-16	16x5	150

Setole ottone. - Brass bristles.



Spazzola orientabile
Adjustable brush
Drehbare Bürste
Brosse orientable
Cepillo orientable

art.	dim. cm.	l.
41766-14	14x7	150



Spazzola orientabile
Adjustable brush
Drehbare Bürste
Brosse orientable
Cepillo orientable

art.	dim. cm.	l.
41739-20	20x6,6	150



Spazzola per griglia, setole in acciaio
Stainless steel brush for grill cleaning
Grillenbürste mit Stahlborsten
Brosser pour grille avec soies en acier inox
Cepillo para parrilla con cerdas de acero

art.	dim. cm.
41740-00	27x4x15



Poggia pala pizza, inox
Support for peels, stainless steel
Schaufelträger aus Edelstahl
Support inox pour pelles à pizza
Portapala para palas, inox

art.	dim. cm.	kg	
41769-36	41x16x39	3,0	fino/up to 36 cm
41769-50	53x16x39	3,5	fino/up to 50 cm



Portapaletto da muro, alluminio
Small pizza peel wall rack, aluminum
Pizzaschaufel-Wandgestell, Aluminum
Support mural petite pelle, aluminum
Soporte mural de pala pizza, aluminio

art.
41769-02



Appendi pala da muro, alluminio
Pizza peel wall rack, aluminum
Pizzaschaufel-Wandgestell, Aluminum
Support mural pour pelle, aluminum
Soporte mural de pala pizza, aluminio

art.
41769-01



Spazzola bi-facciale
Double-sided brush
Bürste Deidseitig
Brosse double face
Cepillo doble

art.	manico/handle l. cm.
41761-02	100



Porta pale, inox
Pizza peel rack, stainless steel
Ständer für Schaufeln, Edelstahl
Support pour pelles, inox
Soporte para pala, inox

art.	h. cm.	kg.
41769-00	172	14

Fornito SENZA pale.
Supplied WITHOUT peels.



Porta pale, inox, base marmo
Pizza peel rack, s/s, marble base
Ständer für Schaufeln, Edelstahl
Support pour pelles, inox
Soporte para pala, inox

art.	dim. cm	h.
41769G00	25x35	183

Fornito SENZA pale.
Supplied WITHOUT peels.



Spazzola orientabile
Adjustable brush
Drehbare Bürste
Brosse orientable
Cepillo orientable

art.	dim. cm	l.
41767G20	20x6	160

Setole ottone. - Brass bristles.



Pala pizza, alluminio
Pizza peel, aluminum
Pizzaschaufel, Aluminum
Pelle à pizza, aluminum
Pala pizza, aluminio

art.	dim. cm	l.
41704G33	33x33	150
41704G36	36x36	150



Palettino forato, inox
Perforated pizza peel, small, s/s
Pizzaschaufel, gelocht, klein, Edelstahl
Petite pelle à pizza perforée, inox
Pala pizza perforada, pequeña, inox

art.	ø cm	l.
41737G20	20	150
41737G23	23	150



P

Pinza per teglie, inox
Pan gripper, stainless steel
Pizzablech-Zange, Edelstahl Rostfrei
Pince à plaques, inox
Pinza fuente horns, inox

art. l. cm.
18323-00 23



P

Pinza per teglie, inox
Pan gripper, stainless steel
Pizzablech-Zange, Edelstahl Rostfrei
Pince à plaques, inox
Pinza fuente horns, inox

art. l. cm.
42822-00 19



P

Tronchetto tagliapizza, inox
Pizza cutter, stainless steel
Pizzaschneider, Edelstahl Rostfrei
Coupe-pizza, inox
Cortador de pizza, inox

art. ø cm. l.
18324-00 13,5 19



P

Forbice pizza smontabile, inox
Divisible pizza scissors, stainless steel
Pizzaschere, teilbar, Edelstahl Rostfrei
Ciseaux à pizza, divisible, inox
Tijeras para pizza desmontables, inox

art. l. cm.
18276-00 25



P

Rotella taglia pizza, inox
Pizza wheel, stainless steel
Pizzaschneider, Edelstahl Rostfrei
Roulette à pizza, inox
Ruleta cortapizzas, inox

art. ø cm.
18324-10 10



P

Coltello per pizzaiolo, inox
Pizza knife, stainless steel
Pizzamesser, Edelstahl Rostfrei
Couteau à pizza, inox
Cuchillo para pizza, inox

art. l. cm.
48280-45 23



N

Coltello per farinata
Farinata knife
Farinata Messer
Couteau à Farinata
Cuchillo Farinata

art. l. cm.
42830-08 8



P

Paletta triangolare, forata, inox
Perforated spatula, stainless steel
Palette, gelocht, Edelstahl Rostfrei
Palette perforée, inox
Pala triangular perforada, inox

art. dim. cm.
18301-01 12x15



P

Paletta triangolare, inox
Spatula, stainless steel
Palette, Edelstahl Rostfrei
Palette, inox
Pala triangular, inox

art. dim. cm.
18301-02 12x15



Pala manicata, alluminio
Peel with handle, aluminum
Schaufel mit Griff, Aluminum
Pelle avec manche, alu
Pala con mango, aluminio

art. ø cm.
42826-32 32
42826-37 37
42826-41 41
42826-45 45



Pala manicata, alluminio
Peel with handle, aluminum
Schaufel mit Griff, Aluminum
Pelle avec manche, alu
Pala con mango, aluminio

art. ø cm. pcs
42827-01 45 6
42827-02 45 8
42827-03 50 6
42827-04 50 8



P

Pala manicata, forata, inox
Perforated peel with handle, s/s
Schaufel mit Griff, gelocht, Edelstahl
Pelle perforée avec manche, inox
Pala con mango, perforada, inox

art. dim. cm.
18302-01 22x18

UTENSILI KITCHEN UTENSILS



P

Pala manicata, inox
Peel with handle, stainless steel
Schaufel mit Griff, Edelstahl Rostfrei
Pelle avec manche, inox
Pala con mango, inox

art.	dim. cm.
18302-02	22x18



Vassoio rotondo liscio, faggio
Round tray, beech wood
Buchenholzbrett, rund
Plateau ronde, bois d'hêtre
Bandeja redonda, madera de haya

art.	ø cm.	h.
41774-33	33	1,2
41774-40	40	1,2
41774-45	45	1,2
41774-50	50	1,2



Vassoio rotondo spicchiato, faggio
Round tray with guides, beech wood
Buchenholzbrett, portionniert
Plateau ronde avec glissières, bois d'hêtre
Bandeja redonda con guías, madera de haya

art.	ø cm.	h.	pcs
41775-45	45	1,2	6
41775-50	50	1,2	8



Tagliere monoporzione, faggio
Cutting board for 1 portion, beech wood
Einzelportion Tablett, Buche
Planche mono-portion, bois d'hêtre
Tabla monoporción, madera de haya

art.	dim. cm.	h.
41775-34	34x20	1,2



Borsa isotermaica
Pizza delivery bag
Thermischetasche
Sac thermique
Bolsa térmica

art.	dim. cm.	Kg.	pz/pcs
44960-06	35x35x20	0,6	5 ø 33cm

Robusto tessuto lavabile, imbottito con anelli di sfianto per la condensa.
Made in heavy tissue, washable. Foam padding for insulation and holes for steam ventilation.



N

Borsa isotermaica
Pizza delivery bag
Thermischetasche
Sac thermique
Bolsa térmica

art.	dim. cm.	h.	pz/pcs
44960-04	46x44	19,5	5 ø 30-4 ø 33

Struttura in nylon, rivestimento in poliestere di 2 cm, chiusura in velcro e manici. Sistema di rilascio del vapore.
Nylon construction 2 cm of polyester insulation, velcro system closure and handles. Steam release system.

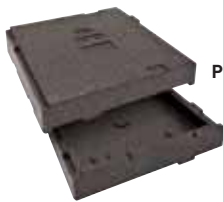

PIZZA SINGLE
35 X 35 CM



BASE E COPERCHIO
BASE AND LID
44975-35



BASE E COPERCHIO
BASE AND LID
44975-50

PIZZA FAMILY
50 X 50 CM



ESTENSORE
EXTENDER
44975H35



ESTENSORE
EXTENDER
44975H50



BASE E COPERCHIO
BASE AND LID
44975-35



BASE E COPERCHIO
BASE AND LID
44975-50

Il sistema modulare dove base e coperchio sono lo stesso elemento e grazie all'inserto estensore è possibile aumentare la capacità.
The modular system where the base and lid are the same element and due to the extender insert it is possible to increase capacity.

Contenitore isotermaico **PIZZA**
Insulated container
Thermobehälter
Conteneur isotherme
Contenedor isotérmico

art.	dim. cm.	h.
44975-35	41x41	7,5
44975H35	41x41	7,5

Contenitore isotermaico **PIZZA**
Insulated container
Thermobehälter
Conteneur isotherme
Contenedor isotérmico

art.	dim. cm.	h.
44975-50	57x57	10,5
44975H50	57x57	10,5



N

Contenitore isotermico **PIZZA**
Insulated container
Thermobehälter
Conteneur isotherme
Contenedor isotérmico

art.	dim. cm.	h.	lt.
44961-03	42x42	34,5	36

Con sistema di rilascio del vapore.
With steam release system.



Tagliapasta flessibile, inox
Dough scraper, flexible, stainless steel
Abstecher, flexibele, Edelstahl Rostfrei
Raclette flexible, inox
Cortapastas flexible, inox

art.	dim. cm.
18501-02	12x9,5



P

Tagliapasta, inox
Dough scraper, stainless steel
Abstecher, Edelstahl Rostfrei
Raclette, inox
Cortapastas, inox

art.	dim. cm.
18501-01	12x16
18501-03	13,5x10
18501-04	12x9,5



P

Raschia, inox
Dough scraper, stainless steel
Teigschäber, Edelstahl Rostfrei
Raclette, inox
Rasqueta, inox

art.	dim. cm.
18501-05	11x19,5



Raschia, inox
Dough scraper, stainless steel
Teigschäber, Edelstahl Rostfrei
Raclette, inox
Rasqueta, inox

art.	dim. cm.
18502-18	18x9



P

Raschia, inox
Dough scraper, stainless steel
Teigschäber, Edelstahl Rostfrei
Raclette, inox
Rasqueta, inox

art.	dim. cm.
18503-12	12x10



P

Raschia, inox
Dough scraper, stainless steel
Teigschäber, Edelstahl Rostfrei
Raclette, inox
Rasqueta, inox

art.	dim. cm.
18504-15	15x7,5



P

Raschia, inox
Dough scraper, stainless steel
Teigschäber, Edelstahl Rostfrei
Raclette, inox
Rasqueta, inox

art.	dim. cm.
18520-15	15x6



Mestolo pizza, fondo piatto
Pizza ladle, flat bottom
Schöpflöffel, flachboden
Louche fond plat
Cacillo fondo plano

art.	ø cm.	l.
12968-10	10	27

PA+
plus



P

Tagliapasta, PS
Dough cutter, PS
Teigschäber, PS
Raclette, PS
Rascador, PS

art.	dim. cm.
47621-11	10x24



P

Tagliapasta, PS
Dough cutter, PS
Teigschäber, PS
Raclette, PS
Rascador, PS

art.	dim. cm.
47621-12	13,5x14,5

Materiale antiurto e antigraffio. Non usare su fonti di calore.
Shock and scratchproof material. Do not use on heat sources.



Contenitore per impasti, impilabile, PE
Dough box, stackable, PE
Behälter für Pizzateig, stapelbar, PE
Réceptient à pétrissage, empilable, PE
Contenedor para masa de pizza, apilable, PE

art.	ext. dim. cm.	int. dim. cm.	lt.
41762-07	60x40x7,5	56,5x36,5x7	14
41762-09	60x40x9,5	56,5x36,5x9	19
41762-13	60x40x13	56,5x36,5x12	26



Coperchio per contenitore, PE
Cover for dough box, PE
Deckel für Pizzateig-Behälter, PE
Couvercle pour réceptient à pétrissage, PE
Tapa para contenedor, PE

art.	dim. cm.
41763-00	60x40



Retina pizza, alluminio
Pizza screen, aluminum
Pizzanetzscheibe, Aluminum
Toile à pizza, aluminium
Red para pizza, aluminio

art.	dim. cm.
41734-60	40x60



Retine pizza, alluminio
Pizza screens, aluminum
Pizzanetzscheiben, Aluminum
Toiles à pizza, aluminum
Red para pizza, aluminio

art.	ø cm.
41727-28	28
41727-30	30
41727-33	33
41727-36	36
41727-40	40
41727-45	45
41727-50	50
41727-55	55
41727-60	60

Senza giunzione. - Without seam.



Rastrelliera per retine, inox
Pizza screen rack, stainless steel
Pizzanetzscheiben-Träger, Edelstahl
Etagère à toiles, inox
Rack para red para pizza, inox

art.	dim. cm.
41771-96	23x35,6

Può contenere 96 retine.
Suitable for 96 pizza screens.



Rastrelliera per teglie pizza, inox
Pizza pan rack, stainless steel
Pizzableche-Träger, Edelstahl
Etagère pour plaques à pizza, inox
Rack para placas pizza, inox

art.	dim. cm.	h.
41770-15	30,5x30,5	70

Distanza fra i piani cm 3,5, per teglie fino a ø 36 cm. - Height between rails cm 3,5, suitable for baking sheets up to ø 36 cm.



Teglia forno, acciaio alluminizzato
Baking sheet, alusteel
Stahlblech mit Aluminumüberzug
Plaque à pizza, tôle aluminite
Placa pizza, acero aluminizado

art.	ø cm.	h.	u.pack
11739-20	20	2,5	10
11739-24	24	2,5	10
11739-28	28	2,5	10
11739-32	32	2,5	10



Teglia pizza, ferro blu pesante
Heavy pizza blue steel sheet
Pizzablech, Blaublech, Schwerausführung
Plaque à pizza, tôle forte bleuie
Placa pizza, hierro pesante

art.	ø cm.	h.	u.pack
11744-20	20	2,5	10
11744-24	24	2,5	10
11744-28	28	2,5	10
11744-32	32	2,5	10



Teglia pizza forata, antiaderente
Perforated pizza sheet, non stick coated
Pizza-Blech, gelocht, beschichtet
Plaque à pizza perforée, anti-adhésive
Placa pizza perforada, antiadherente

art.	ø cm.	h.
41729-30	30	1,3
41729-34	34	1,3



Teglia pizza, antiaderente a 2 strati
Pizza sheet double non stick-coating
Pizzablech mit Doppel-Beschichtung
Plaque à pizza, double revêtement
Placa pizza antiadherente, 2 capas

art.	ø cm.	h.	u.pack
11741-20	20	2,5	5
11741-24	24	2,5	5
11741-26	26	2,5	5
11741-28	28	2,5	5
11741-32	32	2,5	5

Teglia ad alta prestazione, resistente a 280 °C. - High performance sheet, heat resistant up to 280°C.



Teglia pizza, ferro blu
Pizzasheet, blue steel
Pizza-Blaublech
Plaque à pizza, tôle bleuie
Placa pizza, hierro

art.	ø cm.	h.	u.pack
11740-14	14	2,5	5
11740-16	16	2,5	5
11740-18	18	2,5	5
11740-20	20	2,5	5
11740-22	22	2,5	5
11740-24	24	2,5	5
11740-26	26	2,5	5
11740-28	28	2,5	5
11740-30	30	2,5	5
11740-32	32	2,5	5
11740-36	36	2,5	5
11740-40	40	2,5	5



Teglia pizza, ferro blu
Pizzasheet, blue steel
Pizza-Blaublech
Plaque à pizza, tôle bleuie
Placa pizza, hierro

art.	ø cm.	h.	u.pack
11742-16	16	3,5	10
11742-18	18	3,5	10
11742-20	20	3,5	10
11742-22	22	3,5	10
11742-24	24	3,5	10
11742-26	26	3,5	10
11742-28	28	3,5	10
11742-30	30	3,5	10
11742-32	32	3,5	5
11742-36	36	3,5	5
11742-40	40	3,5	5
11742-45	45	4,0	5
11742-50	50	4,0	5
11742-60	60	4,0	5



Teglia rettangolare, ferro blu
Blue steel baking sheet, rectangular
Rechteckiges Blaublech
Plaque rectangulaire, tôle bleuie
Placa rectangular, hierro

art.	dim. cm.	h.
41745-30	30x23	3
41745-35	35x28	3
41745-40	40x30	3
41745-50	50x35	3
41745-60	60x40	3
41745-65	65x45	3



Teglia, alluminata
Baking sheet, alusteel
Rechteckiges Blech, Aluminiumüberzug
Plaque rectangulaire, tôle aluminitée
Placa rectangular, acero aluminizado

art.	dim. cm.	h.
41746-60	60x40	2



Teglia, alluminata
Baking pan, alusteel
Backblech, Aluminiumüberzug
Plaque, tôle aluminitée
Placa, acero aluminizado

art.	dim. cm.	h.
41751-30	30x23	3
41751-35	35x28	3
41751-40	40x30	3
41751-50	50x35	3
41751-60	60x40	3
41751-65	65x45	3



Teglia forata, alluminio
Perforated aluminum baking tray
Aluminum Backbleche, gelocht
Plaque à cuisson perforée, aluminium
Placa pastelería perforada, aluminio

art.	dim. cm.	GN
41756-30	30x40	
41756-32	32,5x53	1/1
41756-53	53x65	2/1
41756-60	60x40	



Teglia rettangolare, antiaderente
Baking sheet, non stick coated
Blech mit Antihafbeschichtung
Plaque avec revêtement anti-adhésif
Placa pastelería anti-adherente

art.	dim. cm.	h.
41747-60	60x40	2



Teglia GN, antiaderente
Baking pan, GN, non stick coated
Backblech, GN, beschichtet
Plaque GN, revêtement anti-adhésif
Placa GN, antiadherente

art.	GN	ø cm.	h.	pcs
41755-11	1/1	12,5	3	6



Teglia, alluminata
Baking pan, alusteel
Backblech, Aluminiumüberzug
Plaque, tôle aluminitée
Placa, acero aluminizado

art.	dim. cm.	ø	h.	pcs
41752-08	60x40	14	3	8
41752-12	60x40	12	3	12
41752-24	60x80	12	3	24



Bacinella carré, ferro blu
Blue steel bread mould
Brotform, Blaublech
Pain de mie, tôle bleuie
Molde, hierro

art.	dim. cm.	h.
41748-20	20x10	10
41748-30	30x10	10
41748-35	35x10	10
41748-40	40x10	10
41748-50	50x10	10



Bacinella carré, alluminata
Bread mould, alusteel
Brotform mit Aluminiumüberzug
Pain de mie, tôle aluminitée
Molde, acero aluminizado

art.	dim. cm.	h.
41750-20	20x10	10
41750-30	30x10	10
41750-40	40x10	10
41750-41	40x15	15
41750-50	50x10	10



Teglia alluminio forato, siliconata
Sheet for French loaves, perforated, silicone coated
Pariserbrotblech, Silikon-beschichtet
Plaque perforée à pain parisien, siliconée
Placa perforada para pan, siliconada

art.	dim. cm.	canali/halfpipe
41758-53	53x32	4
41758-60	60x40	5
41758-65	65x43	6
41758-85	85x43	6



Supporti di cottura Silform® specifici per pane, antiaderenti, ideali per panini tondi, hot dogs, panini al latte, per hamburger, baguettes, ecc., ecc. La loro texture perforata ottimizza il trasferimento del calore per una perfetta croccantezza e doratura del prodotto. Si utilizzano indifferentemente su teglie in alluminio o griglie.

Silform® baking sheets are especially studied for breads, non-stick and ideal for a variety of small bread shapes: round, hot-dogs rolls, soft rolls, submarines, hamburger buns, sandwiches, etc., etc. Thanks to their perforated texture, the heat transfer is optimized, allowing unique crunchy and coloration. Can be used indifferently on aluminum baking trays or grids.

Rotondi - Round

art.	dim. cm.	ø mm.	h.	ml.	pcs
41759-01	60x40	67	15	48	28
41759-02	60x40	75	17	65	24
41759-03	60x40	79	15	65	24
41759-05	60x40	102	20	140	15
41759-09	60x40	125	16	175	11

Ovali - Ovals

art.	dim. cm.	dim. mm.	h.	ml.	pcs
41760-02	60x40	95x40	30	80	24
41760-05	60x40	155x41	25		18
41760-06	60x40	169x64	30		12
41760-08	60x40	259x64	30		8
41760-09	60x40	299x60	30		6





Stampo per pane
Bread mould
Brot-Ausstechforme
Découpoir à pain
Cortador para pan

art. dim. cm.
47041-01 14x10



Stampo per pane
Bread mould
Brot-Ausstechforme
Découpoir à pain
Cortador para pan

art. dim. cm.
47041-02 14x10



Stampo per pane
Bread mould
Brot-Ausstechforme
Découpoir à pain
Cortador para pan

art. Ø cm.
47041-03 12,5

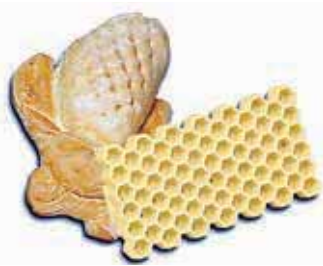

Stampo per pane
Bread mould
Brot-Ausstechforme
Découpoir à pain
Cortador para pan

art. dim. cm.
47041-04 16,5x8,5



Stampo per pane
Bread mould
Brot-Ausstechforme
Découpoir à pain
Cortador para pan

art. Ø cm.
47041-05 12,5



Stampo per pane
Bread mould
Brot-Ausstechforme
Découpoir à pain
Cortador para pan

art. Ø cm.
47041-06 8



Stampo per pane
Bread mould
Brot-Ausstechforme
Découpoir à pain
Cortador para pan

art. Ø cm.
47041-07 8



Stampo per pane
Bread mould
Brot-Ausstechforme
Découpoir à pain
Cortador para pan

art. Ø cm.
47041-08 8



Stampo per pane
Bread mould
Brot-Ausstechforme
Découpoir à pain
Cortador para pan

art. Ø cm.
47041-15 8



Marcatore girevole per pane Kaiser
Kaiser bread marker
Kaiserbrot Stempel
Empreinte pour pain Kaiser
Molde para pan Kaiser

art.
47040-00



UTENSILI KITCHEN UTENSILS



Spazzola pane
Bread brush
Brot-Bürste
Brosse à pain
Cepillo para pan

art.	l. cm.	file/rows
42614-04	24,5	4
42614-05	32,0	5
42614-06	41,0	6
42614-07	46,0	7



Lame panettiere usa e getta, inox
Disposable baker's blades, s/s
Einweg-Bäcker-Klingen, Edelstahl
Incisette boulanger jetables, inox
Láminas del panadero un solo uso, inox

art.	l. cm.	pz/pcs
48290-10	12	10



Cesta pane impilabile, polietilene
Bread basket, stackable, LLDPE
Brot-Korb, stapelbar, LLDPE
Corbeille à pain, empilable, LLDPE
Cesta pan, apilable, LLDPE

art.	dim. cm.	h.	lt.
44982-04	57x36	34	40
44982-06	66x45	35	60
44982-10	78x52	40	100



Cestino impasto, PP
Bread proofing basket, PP
Brotformen, PP
Banneton, PP
Molde para pan, PP

art.	Ø cm.	h.	gr.
47042-19	19	7,5	500
47042-22	22	9,3	1000
47042-25	25	9,0	1500



Cestino impasto, PP
Bread proofing basket, PP
Brotformen, PP
Banneton, PP
Molde para pan, PP

art.	dim. cm.	h.	gr.
47043-27	27x12	6,5	500
47043-35	35x13	7,2	1000
47043-42	42x14	7,5	1500



Cesto cotone, rotondo
Round canvas bag
Brottasche, rund, Baumwolle
Panier à pain rond, coton
Cesta pan redonda, algodón

art.	Ø cm.	h.
42875-17	17	8
42875-20	20	9



Cesto cotone, rotondo
Round canvas bag
Brottasche, rund, Baumwolle
Panier à pain rond, coton
Cesta pan redonda, algodón

art.	Ø cm.	h.
42875B17	17	8
42875B20	20	9



Cesto cotone, ovale
Oval canvas bag
Brottasche, oval, Baumwolle
Panier à pain ovale, coton
Cesta pan , algodón

art.	dim. cm.	h.
42876-20	20x15	7
42876-25	25x18	9

Cotone, lavabile a macchina fino a 30° C. - Cotton, machine-washable up to 30° C.



Cesto cotone, ovale
Oval canvas bag
Brottasche, oval, Baumwolle
Panier à pain ovale, coton
Cesta pan , algodón

art.	dim. cm.	h.
42876B20	20x15	7
42876B25	25x18	9

Cotone, lavabile a macchina fino a 30° C.
Cotton, machine-washable up to 30° C.



Cesto cotone, rotondo
Round canvas bag
Brottasche inklusive Kirschkernkissen, Baumwolle
Panier à pain, coton
Cesta pan, algodón

art.	Ø cm.	h.
42873-01	20	23,5

Cuscino in noccioli di ciliegio incluso. Scaldare in microonde per 90 secondi a 500 Watt.
Cherry stone pillow included. Easy to heat up in microwave for 90 sec. at 500 Watt.



Cesto cotone, ovale
Oval canvas bag
Brottasche, oval, Baumwolle
Panier à pain ovale, coton
Cesta pan , algodón

art.	Ø cm.	h.
42873-02	20	23,5



Cesti pane in polirattan.
Polyrattan bread baskets.



Cesto pane, PP
Bread basket
Brot-Korb
Corbeille à pain
Cesta pan

art.	dim. cm.	h.
42973-30	30x40	16/27



Cesto pane, PP
Bread basket
Brot-Korb
Corbeille à pain
Cesta pan

art.	dim. cm.	h.
42973-45	45x40	16/27



Divisorio, PP
Divider
42973-61



Cesto pane, PP
Bread basket
Brot-Korb
Corbeille à pain
Cesta pan

art.	dim. cm.	h.
42973-60	60x40	16/27



Cesta baguettes, PP
Bread basket
Brotkorb
Corbeille à pain
Cesta pan

art.	ø cm.	h.
42967-35	35	25-42



Cesta baguettes, PP
Bread basket
Brotkorb
Corbeille à pain
Cesta pan

art.	ø cm.	h.
42972-28	30	38



Cesta baguettes, PP
Bread basket
Brotkorb
Corbeille à pain
Cesta pan

art.	ø cm.	h.
42972-29	30	39



Cesto pane, PP
Bread basket
Brot-Korb
Corbeille à pain
Cesta pan

art.	ø cm.	h.
42968-38	38	10



Cesto pane, PP
Bread basket
Brot-Korb
Corbeille à pain
Cesta pan

art.	ø cm.	h.
42968-37	37	9



Cesto pane, PP
Bread basket
Brot-Korb
Corbeille à pain
Cesta pan

art.	ø cm.	h.
42968-42	42	12



Cesto pane, PP
Bread basket
Brot-Korb
Corbeille à pain
Cesta pan

art.	ø cm.	h.
42969-31	31/37	12/6



Cesto pane, PP
Bread basket
Brot-Korb
Corbeille à pain
Cesta pan

art.	ø cm.	h.
42969-36	36,5	12,0
42969-42	42,0	18,5



Cesto pane, PP
Bread basket
Brot-Korb
Corbeille à pain
Cesta pan

art.	dim. cm.	h.
42967-43	45x42	17-24





Cesto pane, PP
Bread basket
Brot-Korb
Corbeille à pain
Cesta pan

art.	dim. cm.	h.
42972-01	40x20	5
42972-02	40x30	5
42972-03	60x20	5
42972-04	60x40	5

Cesto pane, PP
Bread basket
Brot-Korb
Corbeille à pain
Cesta pan

art.	dim. cm.	h.
42967-53	53x32,5	15,5

Cesto pane, PP
Bread basket
Brot-Korb
Corbeille à pain
Cesta pan

art.	dim. cm.	h.
42936-23	23x19	9



Cesto pane, PP
Bread basket
Brot-Korb
Corbeille à pain
Cesta pan

art.	dim. cm.	h.
42936-24	24x17	8,0
42936-28	28x16	8,5

Cesto pane, PP
Bread basket
Brot-Korb
Corbeille à pain
Cesta pan

art.	dim. cm.	h.
42946-23	23x10	6
42946-37	37,5x15	7

Cesto pane, PP
Bread basket
Brot-Korb
Corbeille à pain
Cesta pan

art.	dim. cm.	h.
42947-23	23x15	7
42947-30	30x22	7
42947-40	41x29	7



Cesto pane, PP
Bread basket
Brot-Korb
Corbeille à pain
Cesta pan

art.	ø cm.	h.
42948-18	18	7
42948-20	20	7
42948-25	25	7

Cesto pane, PP
Bread basket
Brot-Korb
Corbeille à pain
Cesta pan

art.	dim. cm.	h.
42948-23	23x15	6,5

Cesto pane, PP
Bread basket
Brot-Korb
Corbeille à pain
Cesta pan

art.	ø cm.	h.
42935-19	19	9
42935-26	26	9



Cesto pane, PP
Bread basket
Brot-Korb
Corbeille à pain
Cesta pan

art.	ø cm.	h.
42944-23	23	7

Cesto pane, PP
Bread basket
Brot-Korb
Corbeille à pain
Cesta pan

art.	dim. cm.	h.
42945-27	27x20	10

Cesto pane, PP
Bread basket
Brot-Korb
Corbeille à pain
Cesta pan

art.	dim. cm.	h.
42945-18	18x13	6,5
42945-23	23x15	6,5



Cesto pane, PP
Bread basket
Brot-Korb
Corbeille à pain
Cesta pan

art.	dim. cm.	h.	GN
42969-11	53,5x32,5	9,5	1/1



Cesto pane, PP
Bread basket
Brot-Korb
Corbeille à pain
Cesta pan

art.	dim. cm.	h.	GN
42965-12	32,5x26,5	8	1/2



Cesto pane, PP
Bread basket
Brot-Korb
Corbeille à pain
Cesta pan

art.	ø cm.	h.	col.
42974C13	13	10	●
42974B13	13	10	●
42974M13	13	10	●
42974N13	13	10	●



41415-11



Cesto pane, PP
Bread basket
Brot-Korb
Corbeille à pain
Cesta pan

art.	dim. cm.	h.	GN
42967-11	56,5x36	10	1/1

Con telaio per fissare il coperchio.
With frame to fix the cover.



41452-53



Cesto pane, PP
Bread basket
Brot-Korb
Corbeille à pain
Cesta pan

art.	dim. cm.	h.	GN
42461-11	56,5x36	10	1/1

Con telaio per fissare il coperchio.
With frame to fix the cover.



42452-35



Cesto pane, PP
Bread basket
Brot-Korb
Corbeille à pain
Cesta pan

art.	ø cm.	h.
42461-35	35	20

Con telaio per fissare il coperchio.
With frame to fix the cover.



WICKER LOOK Cesti pane in polipropilene stampato.
Bread baskets, injection polypropylene



Cesto pane, PP
Bread basket
Brot-Korb
Corbeille à pain
Cesta pan

art.	ø cm.	h.	col.
42974G20	20	6,5	●
42974R20	20	6,5	●
42974B20	20	6,5	●
42974N20	20	6,5	●



Cesto pane, PP
Bread basket
Brot-Korb
Corbeille à pain
Cesta pan

art.	dim. cm.	h.	col.
42974G23	23x17	6,5	●
42974R23	23x17	6,5	●
42974B23	23x17	6,5	●
42974N23	23x17	6,5	●



Cesto pane, PP
Bread basket
Brot-Korb
Corbeille à pain
Cesta pan

art.	dim. cm.	h.	col.
42979B40	39,5x29,5	10	●
42979M40	39,5x29,5	10	●
42979N40	39,5x29,5	10	●



Cesti buffet sistema GN, con telaio in filo inox per stabilizzare il cesto.
Buffet baskets GN system, with stainless steel wire frame to stabilize the basket.



Cesto pane, sistema GN
Bread basket, GN system
Brot-Korb, GN System
Corbeille à pain, système GN
Cesta pan, sistema GN



art.	dim. cm.	h.	GN
42462-11	53x32,5	6,5	1/1
42462-12	32,5x26,5	6,5	1/2
42462-13	32,5x17,5	6,5	1/3
42462-14	26,4x16,2	6,5	1/4
42462-16	17,6x16,2	6,5	1/6
42462-23	32,5x35,4	6,5	2/3

Cesto pane, sistema GN
Bread basket, GN system
Brot-Korb, GN System
Corbeille à pain, système GN
Cesta pan, sistema GN



art.	dim. cm.	h.	GN
42463-11	53x32,5	10	1/1
42463-12	32,5x26,5	10	1/2
42463-13	32,5x17,5	10	1/3
42463-14	26,4x16,2	10	1/4
42463-16	17,6x16,2	10	1/6
42463-23	32,5x35,4	10	2/3



Cesto pane, sistema GN
Bread basket, GN system
Brot-Korb, GN System
Corbeille à pain, système GN
Cesta pan, sistema GN

art.	dim. cm.	h.	GN
42967-63	53x32,5	6,5	1/1
42967-64	32,5x26,5	6,5	1/2
42967-65	32,5x17,5	6,5	1/3
42967-66	26,4x16,2	6,5	1/4
42967-67	17,6x16,2	6,5	1/6
42967-68	32,5x35,4	6,5	2/3

Cesto pane, sistema GN
Bread basket, GN system
Brot-Korb, GN System
Corbeille à pain, système GN
Cesta pan, sistema GN

art.	dim. cm.	h.	GN
42967-73	53x32,5	10	1/1
42967-74	32,5x26,5	10	1/2
42967-75	32,5x17,5	10	1/3
42967-76	26,4x16,2	10	1/4
42967-77	17,6x16,2	10	1/6
42967-78	32,5x35,4	10	2/3



Cesto pane, sistema GN
Bread basket, GN system
Brot-Korb, GN System
Corbeille à pain, système GN
Cesta pan, sistema GN

art.	dim. cm.	h.	GN
42967-03	53x32,5	6,5	1/1
42967-04	32,5x26,5	6,5	1/2
42967-05	32,5x17,5	6,5	1/3
42967-06	26,4x16,2	6,5	1/4
42967-07	17,6x16,2	6,5	1/6
42967-08	32,5x35,4	6,5	2/3

Cesto pane, sistema GN
Bread basket, GN system
Brot-Korb, GN System
Corbeille à pain, système GN
Cesta pan, sistema GN

art.	dim. cm.	h.	GN
42967-13	53x32,5	10	1/1
42967-14	32,5x26,5	10	1/2
42967-15	32,5x17,5	10	1/3
42967-16	26,4x16,2	10	1/4
42967-17	17,6x16,2	10	1/6
42967-18	32,5x35,4	10	2/3



Cesto pane, PP
Bread basket
Brot-Korb
Corbeille à pain
Cesta pan

art.	dim. cm.	h.
42991-25	25x19	6,5
42991-32	32x23	7,0



Cesto pane, PP
Bread basket
Brot-Korb
Corbeille à pain
Cesta pan

art.	dim. cm.	h.
42991M25	25x19	6,5
42991M32	32x23	7,0



Cesto pane, PP
Bread basket
Brot-Korb
Corbeille à pain
Cesta pan

art.	dim. cm.	h.
42991N25	25x19	6,5
42991N32	32x23	7,0



Cesto pane, PP
Bread basket
Brot-Korb
Corbeille à pain
Cesta pan

art.	dim. cm.	h.
42993-40	40X30	10



Cesto pane, PP
Bread basket
Brot-Korb
Corbeille à pain
Cesta pan

art.	dim. cm.	h.
42993M40	40X30	10



Cesto pane, PP
Bread basket
Brot-Korb
Corbeille à pain
Cesta pan

art.	dim. cm.	h.
42993N40	40X30	10



Cesto pane, PP
Bread basket
Brot-Korb
Corbeille à pain
Cesta pan

art.	ø cm.	h.
42990-16	16	8
42990-20	20	8
42990-29	29	7



Cesto pane, PP
Bread basket
Brot-Korb
Corbeille à pain
Cesta pan

art.	ø cm.	h.
42990M16	16	8
42990M20	20	8
42990M29	29	7



Cesto pane, PP
Bread basket
Brot-Korb
Corbeille à pain
Cesta pan

art.	ø cm.	h.
42990N16	16	8
42990N20	20	8
42990N29	29	7



Alzata buffet, legno
Buffet stand, wood
Büffet-Gestell, Holz
Etagère à buffet, bois
Soporte buffet, madera

art.	dim. cm.	h.
42870-59	30,5x59	59

Per cesto Poly rattan 42968-38 e 42967-13 GN 1/1. - Made for Poly rattan basket 42968-38 and 42967-13 GN 1/1.



Supporto cromato, 2 piani
Frame, chrome plated, 2 tiers
Brotkorb-Gestell, Doppeldecker
Support chomé, 2 étages
Estructura cromada, 2 alturas

art.	dim. cm.	h.	GN
42965-AB	29x27	35,0	1/2
42965-AA	50x34	37,5	1/1



Alzata, cromata
Buffet stand, chrome plated
Büffet-Gestell, Metall hartverchromt
Présentoir, chromé
Soporte, cromado

art.	dim. cm.	h.
42872-02	46x24	21

Per cesti Poly rattan 42965-12, 42967-04-14-64-74. - Made for Poly rattan baskets 42965-12, 42967-04-14-64-74.

UTENSILI KITCHEN UTENSILS



Penna a gesso liquido
Chalkmarker
Kreidestifte
Stylo à Craie liquide
Rotulador de tiza líquida

art.	mm.	col.
47832-00	5	bianco/white
47832-01	5	blu/blue
47832-02	5	giallo/yellow
47832-03	5	verde/green
47832-04	5	arancione/orange
47832-05	5	rosso/red
47832-10	15	bianco/white
47832-11	15	blu/blue
47832-12	15	giallo/yellow
47832-13	15	verde/green
47832-14	15	arancione/orange
47832-15	15	rosso/red



Si pulisce con acqua. Scrive su tutte le superfici non porose (lastre, vetro, specchi, materie plastiche, metalli, piastrelle, ecc.)
Clean with water. Writes on all non porous surfaces (chalkboards, glass, mirrors, plastics, metals, tiles, etc.)



Cesta pane, faggio
Beech wood bread box
Holzkiste, Buche
Panier à pain, hêtre
Cesta pan, madera

art.	dim. cm.	h.
42874-01	34x26	12,5
42874-02	34x26	20,0



Tagliere, faggio
Beech wood bread cutting board
Brotschneidbrett, Buche
Planche à découper, hêtre
Tabla de corte, madera

art.	dim. cm.	h.
42874-03	52x34	2



Cesto uova, imbottito, POLYRATTAN
Egg basket, keeps warm
Eier-Korb, hält warm
Panier à oeufs, fourré
Cesta para huevos

art.	ø cm.	h.
42949-27	26	17

Per c.ca 20 uova. - For around 20 eggs.



Cesto uova, imbottito, RATTAN
Egg basket, keeps warm
Eier-Korb, hält warm
Panier à oeufs, fourré
Cesta para huevos

art.	ø cm.	h.
42949-26	26	17



Vassoio, melamina
Melamine tray
Tablett, Melamin
Plateau, melamine
Bandeja, melamine

art.	dim. cm.	h.
42874-04	60x35,5	3,5



10 clip porta etichette flex, PC
10 sign holders, flex
10 Schilderhalter, Flex-Clip
10 porte-étiquettes, flex
10 Porta etiquetas con clip, PC

art.	l. cm.	col.
41392-10	9,5	○
41392B10	9,5	●



10 clip porta etichette, PP
10 sign holders
10 Beschriftungsclips
10 porte-étiquettes
10 Porta etiquetas con clip, PP

art.	dim. cm.	col.
41393-10	6x2,7	○
41393B10	6x2,7	●



2 clip flessibili, cromate
2 sign holders, chromed
2 Schilderhalter, verchromt
2 porte-étiquettes, chromés
2 Porta etiquetas con clip, cromate

art.	h.
41394-02	12

KNIVES

COLTELLERIA
KNIVES
KOCHMESSER
COUTELLERIE
CUCHILLERIA

P **SERIE 18100**

COLTELLI FORGIATI
FORGED KNIVES



Uno studio approfondito e prove computerizzate di ergonomia, movimento e postura hanno permesso a Paderno di creare una linea di coltelli professionali, sintesi perfetta tra comfort e perfezione del taglio. Manico realizzato in speciale materiale plastico sviluppato per il settore alimentare, design ergonomico con bordi arrotondati, presa perfetta per garantire un taglio di precisione. Lama forgiata realizzata in lega di speciale acciaio, molibdeno e vanadio con particolare processo di tempra che garantisce al prodotto un ottimo taglio ed una perfetta e lunga tenuta di filo.

A deep study and computerised tests of ergonomics, movement and posture have allowed Paderno to create a professional knives line, that is the synthesis of comfort and cutting precision. Handle made of plastic specially developed for the food processing sector, ergonomic design with soft edges, perfect grip to ensure precise guidance. The forged blade realised in special steel and molybdenum/vanadium, thanks to a peculiar hardening process, guarantees to the product a perfect cut and a long life of the blade's edge.



Cottello cucina
Cook's knife
Kochmesser
Couteau cuisine
Cuchillo de cocinero

art.	dim. cm.
18100-16	16
18100-20	20
18100-24	24
18100-30	30
18100-36	36



Cottello francese
Butcher's knife
Kochmesser
Couteau de chef
Cuchillo de carnicero

art.	dim. cm.
18102-16	16
18102-20	20
18102-26	26
18102-30	30



Cottello cucina orientale
Oriental cook's knife
Japanisches Kochmesser
Couteau de chef style japonais
Cuchillo cocinero japoné

art.	dim. cm.
18103-18	18



Cottello cucina orientale, alveolato
Oriental cook's knife, dimpled ground
Japanisches Kochmesser mit Kullenschliff
Couteau de chef style japonais alveolé
Cuchillo cocinero japonés, con alvéolos

art.	dim. cm.
18104-18	18



Cottello affettare
Slicer
Fleischmesser
Tranchelard
Cuchillo para filetear

art.	dim. cm.
18106-15	15
18106-20	20
18106-25	25
18106-30	30



Cottello prosciutto
Ham knife
Schinkenmesser
Trancheur à rôti
Cuchillo para jamón

art.	dim. cm.
18109-26	26
18109-30	30
18109-36	36



Cottello prosciutto, alveolato
Ham knife, dimpled ground
Schinkenmesser mit Kullenschliff
Couteau à rôti alvéolé
Cuchillo para jamón, con alvéolos

art.	dim. cm.
18110-26	26
18110-30	30
18110-36	36



Cottello salmone
Salmon knife
Lachsmesser
Couteau à saumon
Cuchillo para salmón

art.	dim. cm.
18111-30	30



Cottello salmone, alveolato
Salmon knife, dimpled ground
Lachsmesser mit Kullenschliff
Couteau à saumon alvéolé
Cuchillo para salmón, con alvéolos

art.	dim. cm.
18112-30	30



Cottello trinciante
Carving knife
Filiermesser
Couteau à découper
Cuchillo para trinchar

art.	dim. cm.
18114-20	20



Coltello filettare, flessibile
Filetting, flexible
Filierrmesser, flexibel
Filet de sole, flexible
Cuchillo para filetear, flexible

art.	dim. cm.
18115-20	20
18115-25	25



Coltello disosso
Boning knife
Ausbeinmesser
Couteau à désosser
Cuchillo para deshuesar

art.	dim. cm.
18116-14	14
18116-18	18



Coltello bistecca
Steak knife
Steakmesser
Couteau à steak
Cuchillo para steak

art.	dim. cm.
18122-12	12



Spelucchino
Paring knife
Spickmesser
Couteau d'office
Cuchillo mondador

art.	dim. cm.
18124-09	9



Spelucchino
Paring knife
Spickmesser
Couteau d'office
Cuchillo mondador

art.	dim. cm.
18125-07	7
18125-10	10



Coltello cuoco
Bent paring knife
Tourniermesser
Bec d'oiseau
Cuchillo verdura

art.	dim. cm.
18126-07	7



Coltello tavola
Table knife
Allzweckmesser
Couteau bout rond cranté
Cuchillo para mesa

art.	dim. cm.
18123-11	11



Coltello pane
Bread knife
Brotmesser mit Wellenschliff
Couteau à pain ondulé
Cuchillo para pan

art.	dim. cm.
18128-20	20
18128-24	24
18128-30	30



Forchettone
Meat fork
Fleischgabel
Fourchette diapason
Tenedor para carne

art.	dim. cm.
18230-13	13
18230-17	17



Forchettone curvo
Carving fork curved
Fleischgabel
Fourchette à viande
Tenedor curvo para carne

art.	dim. cm.
18231-13	13

SERIE 18000 P

COLTELLI SERIE TRANCIATA
STAMPED KNIVES



La linea di coltelleria professionale "CCS" – Color Coding System riduce i rischi di contaminazione incrociata grazie all'utilizzo di un Sistema di Codifica dei Colori che identifica ogni coltello per un uso specifico e permette di individuare facilmente le diverse aree di lavoro. Gli acciai utilizzati per questa linea di coltelleria presentano un'eccezionale durezza ed elevata resistenza alla corrosione, grazie all'uso del sistema ICE-HARDENING, processo speciale per temprare l'acciaio. Per ogni articolo sono riportati i colori del manico in cui si rende disponibile, nonché le dimensioni delle rispettive lame. Il codice indicato nelle tabelle (es. 18000-16) si riferisce al manico in colore nero. Il codice del manico colorato si ottiene sostituendo il trattino con la lettera corrispondente al colore, da ricercarsi nella legenda. Se ad esempio si vuole ordinare un coltello con il manico rosso, la lettera corrispondente è la "R" e il codice di riferimento il 18000R16.

The professional cutlery line "Color-Line" helps to reduce the risk of cross contamination using a Color Coding System which identifies each knife with a specific task: different food processing areas are easily identified. The steel used for this cutlery line has exceptional hardness and very high resistance to corrosion due to ICE-HARDENED system, a special process to harden the steel. The colors of the handle for each article are indicated, as well as the dimensions of the respective blades. The reference in the descriptions (ex. 18000-16) refers to the handle in black color. The code of the colored handle is given by replacing the hyphen with the corresponding letter of the color, please see the key. For instance if you would like to order a knife with the red handle, the corresponding letter is "R" and the reference is 18000R16.

COLTELLERIA KNIVES



R = ROSSO / RED
Carni crude
Raw meat

M = MARRONE / BROWN
Verdure
Vegetables

B = BLU / BLUE
Pesce
Raw fish

Y = GIALLO / YELLOW
Carni cotte, polleria
Cooked meat, poultry

G = VERDE / GREEN
Insalate, frutta
Salad, fruit

W = BIANCO / WHITE
Latticini, pane
Dairy products, bakery



Coltello cucina
Cook's knife
Kochmesser
Couteau cuisine
Cuchillo de cocinero

art.	dim. cm.	colori disponibili / colors available
18000-16	16	●●●●●●●●
18000-20	20	●●●●●●●●
18000-23	23	●●●●●●●●
18000-26	26	●●●●●●●●
18000-30	30	●●●●●●●●
18000-36	36	●



Coltello scimitarra
Butcher's knife
Blockmesser
Couteau à découper
Cuchillo de carnicero

art.	dim. cm.	colori disponibili / colors available
18005-22	22	●●●●●●
18005-27	27	●●●●●●
18005-32	32	●●●●●●



Coltello francese
Butcher's knife
Schlachtmesser
Couteau à découper
Cuchillo carnicero francés

art.	dim. cm.	colori disponibili / colors available
18002-18	18	●●●●
18002-20	20	●●●●
18002-22	22	●●●●
18002-26	26	●●●●●●
18002-30	30	●●●●●●
18002-36	36	●●●●●●



Coltello affettare
Slicer knife
Wurstmesser
Couteau à jambon
Cuchillo para filetear

art.	dim. cm.	colori disponibili / colors available
18006-20	20	●●●●●●
18006-25	25	●●●●●●
18006-30	30	●●●●●●
18006-36	36	●



Coltello affettare, dentato
Slicer knife, wavy blade
Wurstmesser mit Wellenschliff
Couteau à jambon ondulé
Cuchillo para filetear, dentado

art.	dim. cm.	colori disponibili / colors available
18007-25	25	●
18007-30	30	●●
18007-36	36	●



Coltello cucina
Cook's knife
Kochmesser
Couteau cuisine
Cuchillo cocina

art.	dim. cm.	colori disponibili / colors available
18008-20	20	●
18008-26	26	●●
18008-30	30	●●●●
18008-36	36	●●



Coltello prosciutto
Ham knife
Schinkenmesser
Trancheur à rôti
Cuchillo para jamón

art.	dim. cm.	colori disponibili / colors available
18009-25	25	● ○ ● ● ● ● ● ●
18009-30	30	● ○ ● ● ● ● ●
18009-36	36	●



Coltello salmone
Salmon knife
Lachsmesser
Couteau à saumon
Cuchillo salmón

art.	dim. cm.	colori disponibili / colors available
18011-32	32	●



Coltello prosciutto, alveolato
Ham knife, dimpled ground
Schinkenmesser mit Kullenschliff
Couteau à rôti alvéolé
Cuchillo jamón con alvéolos

art.	dim. cm.	colori disponibili / colors available
18010-25	25	●
18010-30	30	● ●
18010-36	36	●



Coltello salmone, alveolato
Salmon knife, dimpled ground
Lachsmesser mit Kullenschliff
Couteau à saumon alvéolé
Cuchillo salmón con alvéolos

art.	dim. cm.	colori disponibili / colors available
18012-32	32	● ●



Coltello salati/Formaggio
Cheese slicer
Universalmesser
Couteau universel
Cuchillo universal/quesos

art.	dim. cm.	colori disponibili / colors available
18013-30	30	● ○
18013-36	36	● ○



Coltello per filettare
Filleting knife
Filiermesser
Filet de sole
Cuchillo para filetear

art.	dim. cm.	colori disponibili / colors available
18015-18	18	● ● ● ● ●
18015-22	22	● ● ● ●
18015-27	27	● ● ●



Coltello disosso
Boning knife
Ausbeinmesser
Couteau à désosser
Cuchillo para deshuesar

art.	dim. cm.	colori disponibili / colors available
18016-14	14	● ● ● ● ●
18016-16	16	● ○ ● ● ● ● ●



Coltello disosso emilia
Boning knife
Ausbeinmesser
Couteau à désosser
Cuchillo para deshuesar

art.	dim. cm.	colori disponibili / colors available
18017-14	14	● ● ● ● ●
18017-16	16	● ● ● ● ● ●
18017-18	18	●



Coltello scannapolli
Poultry sticking knife
Geflügelschlachtmesser
Couteau à volaille
Cuchillo para deshuesar

art.	dim. cm.	colori disponibili / colors available
18018-11	11	● ● ●



Coltello scannare
Sticking knife
Stechmesser
Couteau à saigner
Cuchillo para destrozar

art.	dim. cm.	colori disponibili / colors available
18019-12	12	● ●
18019-14	14	●
18019-16	16	● ● ●
18019-18	18	● ● ● ●
18019-20	20	● ● ● ●

COLTELLERIA KNIVES



Coltello surgelati a doppia lama seghettata
Froozen food, two serrated edges
Tiefkühltruhenmesser, Gezahnter Schliff
Couteau dentelé pour produits surgelés
Cuchillo para congelados, hoja doble, dentada

art. dim. cm. colori disponibili / colors available
18020-23 23 ●●●●



Coltello surgelati lama seghettata speciale
Froozen food special serrated blade
Tiefkühltruhenmesser, Gezahnter Schliff
Couteau dentelé pour produits surgelés
Cuchillo para congelados, dentado especial

art. dim. cm. colori disponibili / colors available
18021-18 18 ●●●●



Coltello bistecca
Steak knife
Steakmesser
Couteau à steak
Cuchillo para steak

art. dim. cm. colori disponibili / colors available
18022-12 12 ●



Coltello tavola, mezzo dentato
Table knife, half-waved
Allzweckmesser
Couteau universel
Cuchillo mesa, medio dentado

art. dim. cm. colori disponibili / colors available
18023-11 11 ●



Spelucchino
Paring knife
Spickmesser
Couteau d'office
Cuchillo mondador

art. dim. cm. colori disponibili / colors available
18024-08 8 ●●●●●●●●
18024-11 11 ●●●●●●●●



Spelucchino
Bent paring knife
Tourniermesser
Bec d'oiseau
Cuchillo verdura

art. dim. cm. colori disponibili / colors available
18026-07 7 ●●●●●



Coltello pasticceria
Baker's knife
Bächrmesser
Couteau de pâtissier
Cuchillo para pastelería

art. dim. cm. colori disponibili / colors available
18029-30 30 ●○
18029-36 36 ●○ seghettato - wavy



Coltello pane
Bread knife
Brotmesser
Couteau à pain
Cuchillo para pan

art. dim. cm. colori disponibili / colors available
18028-21 21 ●○



Coltello pane
Bread knife
Brotmesser
Couteau à pain
Cuchillo para pan

art. dim. cm. colori disponibili / colors available
18028-25 25 ●●●●●
18028-30 30 ●●●●●
18028-36 36 ●○



Coltello dolce
Cake knife
Bächrmesser
Couteau de pâtissier
Cuchillo para pastelería

art. dim. cm. colori disponibili / colors available
18030-26 26 ●○
18030-31 31 ●○
18030-36 36 ●○

PEZZI SPECIALI P

SPECIAL ITEMS



Coltello universale, seghettato
 Universal knife, wavy edge
 Universalmesser mit Wellenschliff
 Couteau universel, lame dentelée
 Cuchillo universal serrado

art.	dim. cm.	colori disponibili / colors available
18029-25	25	● ○



Falcetta cinese
 Slicer, chinese style
 Kochmesser, chinesische Form
 Couteau de cuisine, style chinois
 Cuchillo cocina, estilo chino

art.	dim. cm.	colori disponibili / colors available
18221-17	17	●●●●●●●
18221-19	19	●●●●●●●
18221-21	21	●●●●●●●



Falcetta macellaio
 Meat cleaver
 Hackmesser
 Couperet
 Hacha de carnicero

art.	dim. cm.	Kg.	colori disponibili / colors available
18220-18	18	0,55	●●●●



Falcetta macellaio
 Meat cleaver
 Hackmesser
 Couperet
 Hacha de carnicero

art.	dim. cm.	Kg.	colori disponibili / colors available
18220-20	20	1,1	●●●
18220-22	22	1,3	●●●●



Falcetta macellaio
 Meat cleaver
 Hackmesser
 Couperet
 Hacha de carnicero

art.	dim. cm.	Kg.	colori disponibili / colors available
18220-26	26	1,3	●●●●



Mezzo colpo
 Bone splitter
 Kochschlagmesser
 Couteau de cuisine lourd
 Cuchillo cocina pesado

art.	dim. cm.	Kg.	colori disponibili / colors available
18224-28	28	0,75	●●●●



Colpo
Bone splitter
Kochschlagmesser
Couteau de cuisine lourd
Cuchillo cocina pesado

art. 18225-28 dim. cm. 28 Kg. 1 colori disponibili / colors available ●●



Grana
Parmesan knife
Parmesanmesser
Couteau à Parmesan
Cuchillo para queso

art. 18205-10 dim. cm. 10



Grana
Parmesan knife
Parmesanmesser
Couteau à Parmesan
Cuchillo para queso

art. 18205-12 dim. cm. 12



Coltello segnaforme
Cheese knife
Käsemesser
Couteau à fromage
Cuchillo para queso

art. 18206-09 dim. cm. 9



Coltello lancia "Milano"
Cheese knife
Käsemesser
Couteau à fromage
Cuchillo para queso

art. 18207-15 dim. cm. 15



Coltello apriostriche
Oyster knife
Austernmesser
Couteau à huîtres
Cuchillo ostras

art. 18209-06 dim. cm. 15



Coltello formaggio
Cheese knife
Käsemesser
Couteau à fromage
Cuchillo queso

art. 18201-36 dim. cm. 36



Coltello verdure
Vegetables knife
Gemüsemesser
Couteau à crudités
Cuchillo verduras

art. 18222-18 dim. cm. 18



Cannula disosso prosciutti
Ham boner
Schinkenauslöser
Gouge à jambons
Cuchillo deshuesar jamón

art. 48021-21 dim. cm. 21



Coltello formaggio
Cheese knife
Käsemesser
Couteau à fromage
Cuchillo para queso

art. 18203-26 dim. cm. 26



Coltello gastronomia
Baking pan knife
Winkelmesser
Couteau à gastronomie
Cuchillo gastronomía

art.	dim. cm.
18215-13	13,5



Coltello gastronomia
Baking pan knife
Winkelmesser
Couteau à gastronomie
Cuchillo gastronomía

art.	dim. cm.
18215-21	21,5



Coltello per farinata
Farinata knife
Farinata Messer
Couteau à Farinata
Cuchillo Farinata

art.	l. cm.
42830-08	8



Coltello torta
Pie knife
Tortennmesser
Couteau à gâteau
Cuchillo para tartas

art.	dim. cm.
18514-18	18



Mezzaluna
Mincing knife
Wiegemesser
Hachoir
Media luna

art.	dim. cm.
48017-14	14
48017-25	26



Mezzaluna, lama doppia
Double blade mincing knife
Wiegemesser, Doppel-Klinge
Hachoir double lame
Media luna, doble

art.	dim. cm.
48215-14	14
48215-30	30



Coltello bistecca, manico PP
Steak knife, PP handle
Steakmesser, PP-Heft
Couteau à steak, manche PP
Cuchillo para steak, mango PP

art.	dim. cm.	u. pack
18217-12	12	6



Coltello bistecca/pizza
Steak/pizza knife
Steak-/Pizzamesser
Couteau à steak/pizza
Cuchillo para steak/pizza

art.	dim. cm.	u. pack
18218-12	12	6

COLTELLERIA KNIVES

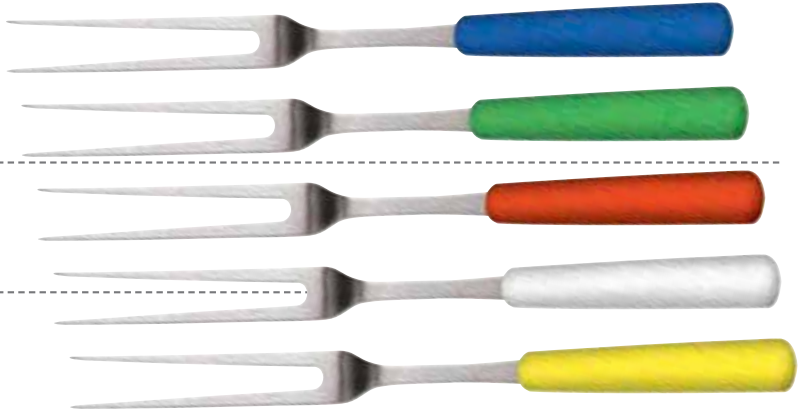

Forchettone
Meat fork
Fleischgabel
Fourchette diapason
Tenedor para carne

art. dim. cm. colori disponibili / colors available
18226-17 17 ● ○ ● ● ● ● ●



Acciaio
Sharpening steel
Wetzstahl
Fusil à affûter
Afilador



art. dim. cm. colori disponibili / colors available
18235-26 26 ●
18235-30 30 ● ○ ● ● ● ● ●



Acciaio ovale
Oval sharpening steel
Wetzstahl, oval
Fusil à affûter, ovale
Afilador ovalado

art. dim. cm.
18236-30 30



Acciaio diamantato
Diamond sharpening steel
Diamant-Wetzstahl
Fusil à affûter, diamant
Afilador adiamantado

art. dim. cm.
18237-26 26



Pietra per affilare
Sharpening stone
Abziehstein
Pierre à aiguiser
Piedra para afilar

art. dim. cm. h. grit
18251-01 21x7 3 1000/240



Pietra per affilare
Sharpening stone
Abziehstein
Pierre à aiguiser
Piedra para afilar

art. dim. cm. h. grit
18251-02 21x7 3 1000/600

AFFILATURA

Acciaio e pietra per affilare, due utensili indispensabili per la buona manutenzione dei coltelli. Per ottenere una corretta affilatura, occorre mantenere un angolo costante di 15-20 gradi tra la lama e il mezzo affilante durante l'operazione.

ACCIAINO

L'acciaio serve a correggere e mantenere l'affilatura dei coltelli. Esso riallinea le molecole che compongono il bordo tagliente, che sono state spostate dagli urti continui, "ripristinando" l'affilatura. L'acciaio tradizionale è di forma tonda, molti chefs usano però un acciaio ovale in quanto la forma più larga permette un movimento di affilatura più ampio ed efficiente. L'acciaio diamantato è invece particolarmente efficace per riaffilare coltelli a lama liscia e può ripristinare un filo di un buon coltello con 6 fino a max 10 movimenti.

SHARPENING

Sharpening steel and stone, two indispensable utensils for the knives' good maintenance. To operate a correct sharpening a constant angle of 15°-20° must be kept between the blade and the sharpening utensils during the operation.

SHARPENING STEEL

The sharpening steel is useful to correct and maintain the knives sharpening. It readjusts the molecules that are the basis of the cutting edge, that have been shifted by the usage. The traditional sharpening steel is round shaped, lots of chefs use anyway an oval shaped one, because the larger shape enables a wider and more efficient sharpening movement. The diamond sharpening steel is particularly indicated for knives with plain blade and can renew a good knife's edge with just 6 to a maximum of 10 movements.

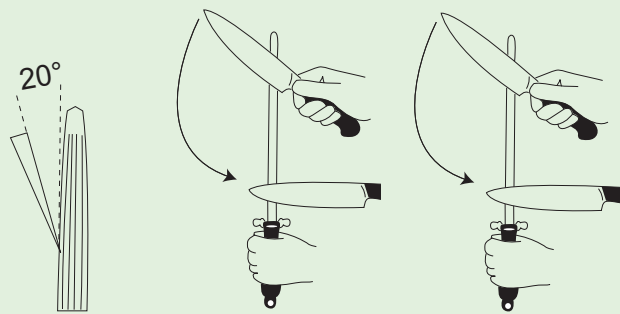

PIETRA ABRASIVA

L'affilatura vera e propria si esegue con la pietra abrasiva, composta di solito da ossido di alluminio o da carburo di silicio e deve necessariamente essere immersa in acqua prima dell'utilizzo, per garantire la sua lubrificazione durante l'uso. Esistono differenti tipi di pietra, identificate da livelli di grana diversi (grossa, media, fine), da utilizzare in relazione allo stato della lama: una pietra con grana fine (1000 grit) si utilizzerà per perfezionare l'affilatura, la grana grossa (300 grit) per un coltello che abbia perduto completamente il filo.

Procedimento di affilatura

Posizionare la pietra abrasiva con il suo supporto in gomma antiscivolo sul piano di appoggio.

Scegliere l'angolo di affilatura (per i coltelli da cucina di uso comune 15-20°).

Applicare un movimento continuo, circolare o alternato alla lama sulla pietra, facendo attenzione a mantenere costante l'angolo di affilatura e a mantenere la lama sempre a contatto con la superficie della pietra.

VALORI DI INCLINAZIONE INCLINATION VALUE

Larghezza lama (l) Width (l)	Altezza inclinazione (h) Height of inclination (h)
2 cm	6 mm
4 cm	12 mm
6 cm	18 mm
8 cm	24 mm
10 cm	30 mm
12 cm	26 mm

ABRASIVE STONE

The true sharpening is done using the abrasive stone, usually composed by aluminum oxide or by silicone carbide and must absolutely be rinsed in water before usage in order to guarantee its lubrication during work. There are several types of stone, identified by different grains (coarse, medium, fine) that have to be used according to the blade condition: a stone with fine grain (1000 grit) will be used to improve the sharpening, a coarse grain (300 grit) for a knife that has completely lost the cutting edge.

Sharpening procedure

Placing the abrasive stone with its no-sliding rubber support on the standing surface.

Choose the sharpening angle (for commonly used kitchen knives 15°-20°).

Move the stone on the blade with a continuous, circular or alternate movement, carefully maintaining the same sharpening angle and always keeping the blade in touch with the stone surface.



Forbice per gamberi
Seafood scissors
Meeresfrüchte Schere
Ciseaux à crevettes
Tijeras para camarones

N

art. dim. cm.
49639-17 17



Forbice per erbe, 5 lame
Herb scissors
Kräuterschere
Ciseaux à herbes
Tijeras hierbas

art. dim. cm.
18277-00 10



Forbice da cucina, smontabile
Divisible kitchen scissors
Küchenschere, teilbar
Ciseaux cuisine, divisible
Tijeras de cocina, desmontables

art. dim. cm.
18271-00 22,6



Forbice multiuso
Kitchen scissors
Küchenschere
Ciseaux cuisine
Tijeras de cocina, multiuso

art. dim. cm.
18272-00 18,5



Forbice da cucina, smontabile
Divisible kitchen scissors
Universal-Küchenschere, teilbar
Ciseaux cuisine, divisible
Tijeras de cocina, desmontables

art. dim. cm.
18273-00 18



Forbice da cucina, smontabile
Divisible kitchen scissors
Küchenschere, teilbar
Ciseaux cuisine, divisible
Tijeras de cocina, desmontables

art. dim. cm.
18274-00 20



Forbice pizza, smontabile
Divisible pizza scissors
Pizzaschere, teilbar
Ciseaux pizza, divisible
Tijeras para pizza, desmontables

art. dim. cm.
18276-00 25



Trinciapollo, smontabile
Divisible poultry shears
Geflügelschere, teilbar
Coupe volailles, divisible
Tijeras para aves, desmontables

art. dim. cm.
18261-00 24



Trinciapollo
Poultry shears
Geflügelschere
Coupe volailles
Tijeras para ave

art. dim. cm.
18263-00 25



Forbice pollame, smontabile
Poultry scissors, divisible
Geflügelschere, teilbar
Ciseaux à volaille, divisible
Tijeras para aves, desmontables

art. dim. cm.
18275-00 26,5

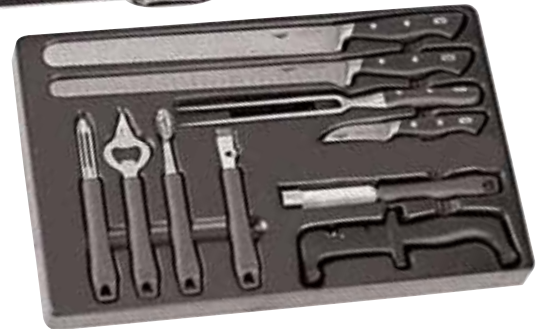

Valigia cuoco, 14 pz.
Chef's set, 14 pieces
Kochkoffer, 14 Stk.
Mallette de chef, 14 pièces
Maleta del Chef, 14 piezas

Valigia cuoco, 17 pz.
Chef's set, 17 pcs
Kochkoffer, 17 Stk.,
Mallette de chef, 17 pcs
Maleta del Chef, 17 piezas

18099-15:	comprendente/includesdim. cm.	
18000-26	cucina / cook's knife	26
18000-30	cucina / cook's knife	30
18002-18	francese / butcher's knife	18
18002-26	francese / butcher's knife	26
18009-30	prosciutto / ham knife	30
18016-16	disosso / boning knife	6
18024-11	spelucchino / paring knife	11
18026-07	spelucchino / paring knife	7
18028-30	pane / bread knife	30
18230-17	forchettone / chef's fork	17
18235-30	acciaino / sharpener	30
18519-26	spatola cuoco / cook's spatula	26
48280-34	pelapatate / potato peeler	
18276-00	forbice pizza / pizza scissors	

18199-19:	comprendente/includesdim. cm.	
18100-24	cucina / cook's knife	24
18100-30	cucina / cook's knife	30
18112-30	salmone alveolato / salmon knife	30
18115-20	filettare / filleting knife	20
18116-14	disosso / boning knife	14
18125-10	spelucchino / paring knife	10
18126-07	spelucchino / bent paring knife	7
18128-30	pane / bread knife	30
18230-17	forchettone / chef's fork	17
18235-30	acciaino / sharpener	30
18276-00	forbice pizza / pizza scissors	
18255-00	affila coltelli / knife sharpener	
48280-25	levatorsoli / apple corer	
48280-34	pelapatate / potato peeler	
48280-02	apribottiglie / can opener	
48280-27	scavino ovale / oval melon baller	
48280-92	decora limoni / lemon stripper	



Rotolo portacoltelli, 9 pz. forgiati
Knife roll-bag, 9 pieces forged
Rolltasche, 9-teilig
Rouleau à couteaux, 9 pièces
Bolsa porta cuchillos, 9 piezas
art.

18190-09

Comprendente/Includes:
cucina/cook's knife cm 24 - affettare/slicer cm 25 - prosciutto/ham knife cm 26 - disosso/boning knife cm 14 - spelucchino/paring knife cm 9 - pane/ bread knife cm 24 - forchettone/chef's fork - acciaino/sharpener - forbice cucina/kitchen scissors.



Barra magnetica
Magnetic knife rack
Magnet-Messerhalter
Porte-couteaux magnetic
Barra magnética portas cuchillos

art.	l. cm.
48032-30	30
48032-45	45
48032-60	60



Etlund

Ceppo porta coltelli, inox
Knife block, stainless steel
Messerblock, Edelstahl Rostfrei
Bloc à couteaux, inox
Bloque portacuchillos, inox

art.	dim. cm.	h.
49875-06	26x14	33



P

Ceppo porta coltelli legno, set 9 pz
Wood knife block, 9 pcs set
Holz-Messerblock, 9-tlg.
Bloc à couteaux en bois, set 9 pièces
Bloque portacuchillos de madera, 9 piezas

art. 18192-09

Comprendente/Includes:
18100-20 cucina/cook's knife cm 20



18106-20 affettare/slicer cm 20



18124-09 spelucchino/paring knife cm 9



18128-20 pane/ bread knife cm 20



18230-17 forchettone/chef's fork cm 17



18235-26 acciaino/sharpener cm 26



18271-00 forbice cucina/kitchen scissors



18102-16 francese/butcher's knife cm 16

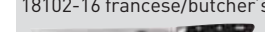

18126-07 cuoco/paring knife cm 7.

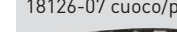

P

Ceppo porta coltelli, silicone
Knife block, silicone
Messerblock, Silikon
Bloc à couteaux, silicone
Bloque portacuchillos, silicona

art.	ø cm.	h.
18191-22	10,5	22,5



Ideale per ogni tipo di coltello, l'inserto removibile e facile da lavare è formato da astine flessibili che tengono i coltelli in posizione. Coltelli non inclusi. - To store any type of knives, the flexible rods hold knives in place anywhere in the block and can be removed for easy washing. Knives not included.



48040-AA



Porta coltelli, inox
Knife rack, stainless steel
Messeraufhänger, Edelstahl Rostfrei
Support à couteaux, inox
Porta cuchillos, inox

Etlund

art.	dim. cm.	h.
48040-00	30,5x6,6	30,5
48040-AA	30,5x6,6	

Può contenere 8 coltelli cuoco, più 2 coltelli più piccoli, 1 acciaino e forbici.
Holds 8 chef's knives, plus 2 smaller knives, 1 steel and scissors



Porta coltelli, inox
Knife rack, stainless steel
Messeraufhänger, Edelstahl Rostfrei
Support à couteaux, inox
Porta cuchillos, inox

Etlund

art.	dim. cm.	h.
48040-10	30,5x6,6	35,6
48040-AA	30,5x6,6	



Porta coltelli, inox
Knife rack, stainless steel
Messeraufhänger, Edelstahl Rostfrei
Support à couteaux, inox
Porta cuchillos, inox

Etlund

art.	dim. cm.	h.
48039-06	15,2x6,6	30,5

Può contenere 1 mannaia e 4 coltelli cuoco o 6 coltelli cuoco o 8 coltelli affettare o 12 spelucchini e 1 acciaino tondo. - Holds 1 cleaver and 4 chef knives or 6 chef knives or 8 slicers or 12 paring knives and 1 round or diamond steel.

COLTELLERIA KNIVES
ACCESSORI ACCESSORIES



Illustrazione con tubo di drenaggio opzionale.
Shown with optional drainage tube.



Sterilizzatore ad immersione
Knife sanitizing system
Messerentkeimer
Stérilisateur à couteaux
Esterilizador a inmersión



art.	dim. cm.	h.
48040-50	45,7x11,5	45,7

Il serbatoio permette la sterilizzazione ad immersione dell'intera lama. Fissaggio al muro stabile e sicuro. Inserti e serbatoio estraibili per una facile pulizia. - The liquid sanitizing tank allows for submersion of the entire blade. Secure wall mounting. Removable inserts and tank for easy cleaning.



Pulisci coltelli
Knife cleaner
Messerabstreifbehälter
Nettoyeur à couteaux
Limpiador de cuchillos

art.	ø cm.	h.
48038-10	13	18



Sterilizzatore 20 coltelli ad 1 porta, inox
Knife sterilizer for 20 pcs, stainless steel
Elektro-Messerentkeimer, Edelstahl Rostfrei
Armoire de sterilisation, inox
Esterilizador para cuchillos, inox

art.	dim. cm.	h.	V	W
49871-10	57,5x17	60	230	15

Sterilizzatore 40 coltelli ad 1 porta, inox
Knife sterilizer for 40 pcs, stainless steel
Elektro-Messerentkeimer, Edelstahl Rostfrei
Armoire de sterilisation, inox
Esterilizador para cuchillos, inox

art.	dim. cm.	h.	V	W
49871-20	103x17	60	230	30

Porta in plexiglas, chiusura magnetica. Programmabile da 0 a 2 ore. Dispositivo d'arresto all'apertura porta. Indice di protezione IP 24. - Plexiglas door, magnetic lock. Timer setting from 0 up to 2 hours. Door with stop device when opening. Protection IP 24.



Affilacoltelli manuale
Manual sharpener
Messer Schleifapparat
Affûteur manuel
Afilador manual

art.
18255-00



Affilacoltelli elettrico, inox
Electric knife sharpener, stainless steel
Elektro-Messerschleifapparat, Edelstahl Rostfrei
Aiguiseur électrique, inox
Afilador eléctrico, inox

art.	dim. cm.	h.	kg.
49872-00	25x10	12	4

230V-172W, Rpm 1.550 - Guida in ABS estraibile. Motore con dispositivo autobloccante. - ABS knife guide. Pressure sensitive motor shuts down automatically.



Affilacoltelli elettrico
Electric knife sharpener
Elektro-Messerschleifapparat
Aiguiseur électrique
Afilador eléctrico

art.	dim. cm.	h.	kg.	V
49741-15	23x33	16	6,4	220/240

Affilacoltelli elettrico
Electric knife sharpener
Elektro-Messerschleifapparat
Aiguiseur électrique
Afilador eléctrico

art.	dim. cm.	h.	kg.	V
49741-07	23x16	16	4,6	220/240



Affilacoltelli manuale
Manual sharpener
Messer Schleifapparat
Affûteur manuel
Afilador manual

art.
49739-00

COLTELLERIA KNIVES



Pungisalame
Salami pricker
Salamistachel
Pique saucisson
Picadura pra embutido

art.
42523-00



Ago lardellare, con becco, inox
Larding needle, with flap, stainless steel
Spicknadel, mit Klappe, E.R.
Lardoire à clapet, inox
Aguja con clip, inox

art. l. cm. Ø mm.
42514-20 20 5



Ago da cucina, inox
Lacing needle, straight, stainless steel
Dressiernadel, gerade, E.R.
Aiguille à brider, droite, inox
Aguja de cocina, inox

art. l. cm.
42515-18 18
42515-20 20



Ago da cucina, curvo, inox
Lacing needle, bent, stainless steel
Dressiernadel, gebogen, E.R.
Aiguille à brider, courbe, inox
Aguja de cocina, inox

art. l. cm.
42516-18 18
42516-20 20



Set 5 aghi, inox
Set 5 pcs needles, stainless steel
Nadelsatz, 5 Stk., E.R.
Set 5 aiguilles, inox
Set 5 agujas, inox

art.
42517-06



Gruppo sei spiedini, inox
Set 6 skewers, stainless steel
Satz 6 Stk. Fleischspieß, E. R.
Set 6 brochettes, inox
Set 6 palos para asar, inox

art. l. cm.
42529-06 30



Taglia spiedini, inox
Kebabs preparation appliance, stainless steel
Fleischspießschneider, Edelstahl Rostfrei
Coupe-brochettes rapides, inox
Cortador para pinchos, inox

art. dim. cm. h. kg.
49877-12 16,5x12 28,5 2,2

Fornito con 12 spiedini.
Supplied with 12 skewer picks.



Spiedini piatti, 18/8
Skewers, 18/8
Fleischspieß, 18/8
Brochettes, 18/8
Pinchos, 18/8

art. dim. mm. u. pack
42511-20 200x3 10
42511-25 250x3 10
42511-30 300x3 10
42511-35 350x3 10
42511-40 400x3 10
42511-56 560x5 10

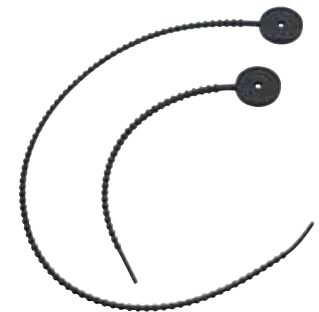

Laccetti da cucina, set 6 pezzi
Kitchen strings, 6 pcs set
Silikonbänder, Satz 6 Stk.
Lacets de cuisson, set 6 pcs.
Correas, juego 6 pz.

art. l. cm.
51595B44 22
51595B45 53

Laccetto da cucina in alternativa allo spago da cucina. Realizzato in silicone alimentare al 100%. - Silicone kitchen strings as alternative to twine and rope. Made of 100% food-grade silicone.



Spade, 18/8
Swords, 18/8
Schwerter, 18/8
Epées, 18/8
Espadas, 18/8

art. dim. mm.
42511-60 600x15x3
42511-70 700x15x3



Gancio ad ancora, inox
Anchor meat hook, stainless steel
Anker Fleischhaken, Edelstahl Rostfrei
Esse à ancre, inox
Gancho forma ancla, inox

art. Ø cm. l. u. pack
42507-12 0,7 13 10





Gancio girevole, inox
Sliving meat hook, stainless steel
Fleischdrehhaken, Edelstahl Rostfrei
Esse-tournante, inox
Gancho giratorio, inox

art.	Ø cm.	l.	u. pack
42525-27	1,2	27	10



Gancio fisso, 2 punte, inox
Meat hook, 2 peacks, stainless steel
Fleischhaken, 2 Spitze, E. R.
Crochet esse, 2 pointes, inox
Gancho 2 puntas, inox

art.	Ø cm.	l.	u. pack
42524-06	0,3	6	10
42524-08	0,4	8	10
42524-10	0,4	10	10
42524-12	0,5	12	10
42524-14	0,5	14	10
42524-16	0,6	16	10
42524-18	0,6	18	10
42524-20	0,9	20	10
42524-22	0,9	22	10
42524-30	1,2	30	10



Gancio fisso, 1 punta, inox
Meat hook, 1 peack, stainless steel
Fleischhaken, 1 Spitze, E. R.
Crochet esse, 1 pointe, inox
Gancho 1 punta, inox

art.	Ø cm.	l.	u. pack
42506-08	0,3	8	10
42506-10	0,4	10	10
42506-12	0,5	12	10
42506-14	0,5	14	10
42506-16	0,6	16	10
42506-18	0,6	18	10



Gancio girevole, inox
Sliving meat hook, stainless steel
Fleischdrehhaken, Edelstahl Rostfrei
Esse-tournante, inox
Gancho giratorio, inox

art.	Ø cm.	l.
42505-21	0,9	22
42505-24	1,0	26
42505-27	1,2	28
42505-50	1,2	50



Gancio scorrevole, inox
Meat hook, stainless steel
Fleischhaken, Edelstahl Rostfrei
Crochet coulissant, inox
Gancho, inox

art.	Ø cm.	l.	u. pack
42526-12	0,9	12	10
42526-14	1,2	14	10



Pinza per affettati, inox
Ham-tong, stainless steel
Schinkenzange, Edelstahl Rostfrei
Pince à jambon, inox
Pinza para jamón, inox

art.	cm.
42510-00	11x6



Batticarne a pugno, inox
Meat tenderizer, stainless steel
Kotelettklopfer, Edelstahl Rostfrei
Aplatisseur, inox
Aplasta carnes, inox

art.	Kg.
42501-15	1,5
42501-20	2,0



Batticarne a due tagli, inox
Meat tenderizer, stainless steel
Kotelettklopfer, Edelstahl Rostfrei
Aplatisseur, inox
Aplasta carnes, inox

art.	Kg.
42502-11	1,1



Batticarne a paletta, inox
Meat tenderizer, stainless steel
Kotelettklopfer, Edelstahl Rostfrei
Aplatisseur, inox
Aplasta carnes inox

art.	Kg.
42503-10	1



Batticarne, alluminio
Steak hammer, aluminum
Aluminum-Fleischklopfer
Attendrisseur, alu
Aplasta carnes, aluminio

art.	l. cm.	Kg.
42508-00	32	0,6



Batticarne, alluminio
Steak hammer, aluminum
Aluminum-Fleischklopfer
Attendrisseur, alu
Aplasta carnes, aluminio

art.	l. cm.	Kg.
42508-01	25	0,41



Sega per ossa, inox
Bone-saw, stainless steel
Knochensäge, Edelstahl Rostfrei
Scie à os, inox
Sierra de cocina, inox

art.	l. cm.
48231-40	40
48231-45	45
48231-50	50



Portaspago, inox
String holder, stainless steel
Schnurrolle-Halter, Edelstahl Rostfrei
Porte rolls sur socle, inox
Porta cuerda, inox

art.	dim. cm.	h.
42579-00	19x12	17



Portaspago, inox
String holder, stainless steel
Schnurrolle-Halter, Edelstahl Rostfrei
Porte rolls sur socle, inox
Porta cuerda, inox

art.	dim. cm.	h.
42579-01	17x14,5	20



Vassoio rettangolare, inox
Meat pan, stainless steel
Fleischblech, Edelstahl Rostfrei
Plat boucher, inox
Bandeja rectangular, inox

art.	dim. cm.	h.
42534-26	26x23	2
42534-32	34x21	2
42534-41	45x25	2



Vassoio espositore, inox
Display tray, stainless steel
Ausstellplateau, Edelstahl Rostfrei
Plateau, inox
Bandeja expositora, inox

art.	dim. cm.	h.
42532-29	29x21	2
42532-58	58x21	2



Contenitore con griglia, inox
Pan with grid, stainless steel
Plateau mit Siebeinsatz, E. R.
Plat boucher avec grille, inox
Contenedor con rejilla, inox

art.	dim. cm.	h.
42531-26	24,4x21,6	5,5
42531-32	32x23	5,5
42531-41	41x31	5,5
42531-50	50x35	5,5



Contenitore, inox
Pan, stainless steel
Plateau, Edelstahl Rostfrei
Plat bouchera, inox
Contenedor, inox

art.	dim. cm.	h.
42530-26	24,4x21,6	5,5
42530-32	32x23	5,5
42530-41	41x31	5,5
42530-50	50x35	5,5



Ferma prosciutto base marmo
Ham stand on marble
Schinkenhalter, Marmorsocket
Pince à jambon sur marbre
Jamonero, base mármol

art.	dim. cm.	h.	kg.
41583-00	24x45	15	10,3



Ferma prosciutto base legno
Ham stand on wood
Schinkenhalter, Holzsocket
Pince à jambon sur bois
Jamonero, base madera

art.	dim. cm.	h.	kg.
41582-00	24x45	16	4,5



Pressa-hamburger, inox
Hamburger press, stainless steel
Hamburgerpresse, Edelstahl Rostfrei
Moule à steak, inox
Prensa para hamburguesa, inox

art.	dim. cm.	l.
42864-00	11x8	36



Pressa-hamburger, inox
Hamburger press, stainless steel
Hamburgerpresse, Edelstahl Rostfrei
Moule à steak, inox
Prensa para hamburguesa, inox

art.	ø cm.	l.
42864-10	10	36



Pressa-hamburger, alluminio anodizzato
Hamburger press, anodized aluminum
Hamburgerpresse, Aluminium eloxiert
Moule à steak, aluminium anodisé
Prensa para hamburguesa, aluminio anodizado

art.	dim. cm.	h.	kg.
49978-10	37x25	50	5,0
49978-13	42x27,5	53	5,5

Parti a contatto con il cibo in acciaio inox per alimenti. The parts coming into contact with food are in stainless steel.



Insaccatrice verticale
Vertical manual sausage filler
Wurstfüller
Poussoir manuel vertical
Ensacadora vertical

art.	dim. cm.	lt.	kg.
49876-03	30x22x47,5	3	6,2

Accessori: 3 imbuto.
Equipment: 3 funnels.



Tritacarne elettrico
Electric meat mincer
Elektr. Fleischwolf
Hachoir électrique
Tritador de carne, eléctrico

art.	dim. cm.	h.	kg.	V	KW
49921-00	18x42	43	6	220-240	0,35



Tritacarne elettrico
Electric meat mincer
Elektr. Fleischwolf
Hachoir électrique
Tritador de carne, eléctrico

art.	dim. cm.	h.	kg.	V	KW
49920-00	18x35	38	3,2	220-240	0,2



Accessorio grattugia
Grater accessory
Raffel für Fleischwolf
Accessoire bloc râpeur
Accesorio ralladora

art.	kg.
49921-10	1,6

Dotazione 3 cilindri: verdure, parmigiano, gruviera. - Equipment 3 drums: rawness, parmesan, gruyère.



Affettatrice elettrica
Electric slicer
Elektr. Aufschnitt-Maschine
Trancheur électrique
Cortadora eléctrica

art.	ø cm.	dim.	h.	V	HP	kg.	rpm
49975-19	19,5	52x36	31,5	230	0,2	10	300 CE
49975U19*	19,5	52x36	31,5	230	0,2	10	300 extra CE

* Affilatoio fisso. - Built-in blade sharpener.
Spessore taglio mm. 0÷15. Taglio utile cm 14x14. Costruzione in lega di alluminio anodizzato. - Cut thickness range mm 0÷15. Cut cm 14x14. Anodized aluminum construction.



Affettatrice elettrica
Electric slicer
Elektr. Aufschnitt-Maschine
Trancheur électrique
Cortadora eléctrica

art.	ø cm.	dim.	h.	V	HP	kg.	rpm
49975-25	25	62x42,5	37	230	0,3	15,5	300 CE
49975U25*	25	62x42,5	37	230	0,3	15,5	300 extra CE

* Affilatoio fisso, motore ventilato. - Built-in blade sharpener, ventilated motor. Spessore taglio mm. 0÷16. Taglio utile cm 22x19. Costruzione in lega di alluminio anodizzato. - Cut thickness range mm 0÷16. Cut cm 22x19. Anodized aluminum construction.



Affettatrice elettrica
Electric slicer
Elektr. Aufschnitt-Maschine
Trancheur électrique
Cortadora eléctrica

art.	ø cm.	dim.	h.	V	HP	kg.	rpm
49975-22	22	58x40,5	34	230	0,25	10	300 CE
49975U22*	22	58x40,5	34	230	0,25	10	300 extra CE

* Affilatoio fisso, motore ventilato. - Built-in blade sharpener, ventilated motor. Spessore taglio mm. 0÷15. Taglio utile cm 19x16. Costruzione in lega di alluminio anodizzato. - Cut thickness range mm 0÷15. Cut cm 19x16. Anodized aluminum construction.



Affettatrice elettrica
Electric slicer
Elektr. Aufschnitt-Maschine
Trancheur électrique
Cortadora eléctrica

art.	ø cm.	dim.	h.	V	HP	kg.	rpm
49975-30	30	65x49,5	44	230	0,35	23	300 CE
49975U30*	30	65x49,5	44	230	0,35	23	300 extra CE

* Affilatoio fisso, motore ventilato. - Built-in blade sharpener, ventilated motor. Spessore taglio mm. 0÷16. Taglio utile cm 22x22. Costruzione in lega di alluminio anodizzato. - Cut thickness range mm 0÷16. Cut cm 22x22. Anodized aluminum construction.





Affettatrice elettrica
Electric slicer
Elektr. Aufschnitt-Maschine
Trancheur électrique
Cortadora eléctrica

art.	ø cm.	dim.	h.	V	HP	kg.	rpm
49975-35	35	89x58,5	48	220	0,5	36	260 CE
49975U35*	35	89x58,5	48	220	0,5	36	260 extra CE

* Affilatoio fisso, motore ventilato. - **Built-in blade sharpener, ventilated motor.** Spessore taglio mm. 0÷15. Taglio utile cm 31x26. Costruzione in lega di alluminio anodizzato. - **Cut thickness range mm 0÷15. Cut cm 31x26. Anodized aluminum construction.**



Affettatrice elettrica
Electric slicer
Elektr. Aufschnitt-Maschine
Trancheur électrique
Cortadora eléctrica

art.	ø cm.	dim.	h.	V	HP	kg.	rpm
49974-25	25	53x52	50	230	0,35	24	300 CE
49974U25	25	53x52	50	230	0,35	24	300 extra CE

Affilatoio incorporato. Spessore taglio mm. 0÷16. Taglio utile cm 22x22. Costruzione in lega di alluminio anodizzato. - **Built-in blade sharpener.** Cut thickness range mm 0÷16. Cut cm 22x22. Anodized aluminum construction.



Affettatrice elettrica
Electric slicer
Elektr. Aufschnitt-Maschine
Trancheur électrique
Cortadora eléctrica

art.	ø cm.	dim.	h.	V	HP	kg.	rpm
49974-30	30	53x52	50	230	0,5	27	CE
49974U30	30	53x52	50	230	0,5	27	300 extra CE

Affilatoio incorporato. Spessore taglio mm. 0÷16. Taglio utile cm 26x21. Costruzione in lega di alluminio anodizzato. - **Built-in blade sharpener.** Cut thickness range mm 0÷16. Cut cm 26x21. Anodized aluminum construction.



Affettatrice
Slicer
Aufschnitt-Maschine
Trancheur
Cortadora

art.	ø cm.	dim.	h.	kg.	corsa piatto/race
49971-25	25	68x52	51	33	20,5 cm

Spessore taglio mm. 0÷2,3. 8 scatti. Taglio utile cm 18,5x15. **Cut thickness range mm 0÷2,3. 9 cutting positions. Cut cm 18,5x15.**



Affettatrice
Slicer
Aufschnitt-Maschine
Trancheur
Cortadora

art.	ø cm.	dim.	h.	kg.	corsa piatto/race
49972-30	30	72x60	74	45,5	20,5 cm

Spessore taglio mm. 0÷2,5. 9 scatti. Taglio utile cm 23x19. - **Cut thickness range mm 0÷2,5. 9 cutting positions. Cut cm 23x19.**



OPTIONAL VOLANO

art.	
49970-AR	Volano rosa/ Rose handwheel
49970-AM	Volano margherita/ Daisy handwheel



VOLANO 250 - 300

Le affettatrici a volano sono costruite in alluminio, con parti in acciaio e una verniciatura a forno. A funzionamento manuale. Affilatoio incorporato. Dotate di protezione ad anello attorno alla lama; conformi agli standard di prodotto CEE.

Made of aluminium with parts of steel and black finishing. Fully hand-operated. Built-in blade sharpener. Equipped with protecting ring around the blade; in conformity with CE standards.



OPTIONAL VOLANO

art.		dim. cm
49971P25	Piedistallo/ Stand	65x80
49972P30	Piedistallo/ Stand	65x80



OPTIONAL VOLANO

art.		dim. cm
49971R00	Piedistallo con ruote Stand with wheels	65x80

COLTELLERIA KNIVES



Spazzola per ceppa
Block brush, plastic handle
Blockbürste, Kunststoffgriff
Brosse à billot, matière plastique
Cepillo para cepa

art. l. cm.
42518-01 20



Tagliere con vasca, PE
Cutting board with tray, PE
Tranchierbrett mit Tablett, PE
Planche à découper avec plateau, PE
Tabla de corte con bandeja, PE

art. dim. cm. h.
44947-00 33,5x46 5,5



Tagliere bar, PE
Cutting board, PE
Tranchierbrett, PE
Planche à découper, PE
Tabla de corte, PE

art. dim. cm. h.
42521-16 16x24,5 1
42521-24 24,5x32,5 1

HD-PE	03 = ROSSO / RED Carni crude Raw meat and poultry Rohes Fleisch Viande crue Carne cruda	02 = MARRONE / BROWN Verdure crude Raw vegetables Rohes Gemüse Cruautés Verduras crudas	04 = BLU / BLUE Pesce Raw fish Fisch Poisson Pescado	01 = GIALLO / YELLOW Carni cotte Cooked meats Gekochtes Fleisch Viande cuite Carne cocida	05 = VERDE / GREEN Insalata e frutta Salads and fruits Salat und Früchte Salade et fruits Ensalada y fruta	00 = BIANCO / WHITE Pane e formaggi Bakery and dairy products Brot und Käse Pain et fromages Pan y quesos



Tagliere in polietilene HD
Cutting board, PE HD
Tranchierbrett, PE HD
Planche à découper, PE HD
Tabla de corte, PE HD

art.	dim. cm.	h.	GN
○42522-00	32x26,5	2	1/2
●42522-01	32x26,5	2	1/2
●42522-02	32x26,5	2	1/2
●42522-03	32x26,5	2	1/2
●42522-04	32x26,5	2	1/2
●42522-05	32x26,5	2	1/2
●42522-09	32x26,5	2	1/2



Tagliere in polietilene HD
Cutting board, HD polyethylene
Tranchierbrett, PE HD
Planche à découper, PE HD
Tabla de corte, PE HD

art.	dim. cm.	h.	GN
○42538-00	53x32,5	2	1/1
●42538-01	53x32,5	2	1/1
●42538-02	53x32,5	2	1/1
●42538-03	53x32,5	2	1/1
●42538-04	53x32,5	2	1/1
●42538-05	53x32,5	2	1/1
●42538-09	53x32,5	2	1/1



Tagliere in polietilene HD
Cutting board, HD polyethylene
Tranchierbrett, PE HD
Planche à découper, PE HD
Tabla de corte, PE HD

art.	dim. cm.	h.
○42539-00	60x40	2
●42539-01	60x40	2
●42539-02	60x40	2
●42539-03	60x40	2
●42539-04	60x40	2
●42539-05	60x40	2
●42539-09	60x40	2



Tagliere con canalina, PE
Cutting board with groove, PE
Tranchierbrett, PE
Planche à découper avec rigole, PE
Tabla de corte con ranura, PE

art.	dim. cm.	h.	GN
○42546-00	65x53	2	2/1
●42546-01	65x53	2	2/1
●42546-02	65x53	2	2/1
●42546-03	65x53	2	2/1
●42546-04	65x53	2	2/1
●42546-05	65x53	2	2/1

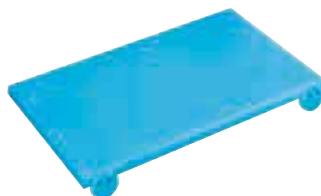

Tagliere in PE HD, con fermi
Cutting board with stoppers, HD PE
Tranchierbrett mit Stiften, PE HD
Planche à découper avec arrêts, PE HD
Tabla de corte, PE HD

art.	dim. cm.	h.	GN
○42543-00	53x32,5	2	1/1
●42543-01	53x32,5	2	1/1
●42543-02	53x32,5	2	1/1
●42543-03	53x32,5	2	1/1
●42543-04	53x32,5	2	1/1
●42543-05	53x32,5	2	1/1



Tagliere in polietilene HD, con fermi
Cutting board with stoppers, HD PE
Tranchierbrett mit Stiften, PE HD
Planche à découper avec arrêts, PE HD
Tabla de corte, PE HD

art.	dim. cm.	h.
○42544-00	60x40	2
●42544-01	60x40	2
●42544-02	60x40	2
●42544-03	60x40	2
●42544-04	60x40	2
●42544-05	60x40	2



42519-01

42518-50

Ceppa in polietilene
PE butchers table
Hackblock, PE
Billot, PE
Cepa en polietileno

art.	dim.cm.	h.	mm.*
42518-50	50x50	86	40

Ceppo/Worktop

42519-01	50x50	4	
----------	-------	---	--

* Spessore. - Thickness.



Tagliere in polietilene HD
Cutting board, PE HD
Tranchierbrett, PE HD
Planche à découper, PE HD
Tabla de corte, PE HD

art.	dim. cm.	h.	GN
42522-07	32x26,5	2	1/2
42538-07	53x32,5	2	1/1
42539-07	60x40	2	



Set 6 taglieri colorati, polietilene
Set 6 colored cutting boards, PE
6 Stk. Tranchierbretter, Polyäthylen
6 planches à découper, PE
Juego 6 tabla de corte, PE

art.	dim. cm.	h.
42541-06	46x31	1,3



Raschietto, polietilene
Board scraper, PE
Blockschäber, PE
Racloir à planches, PE
Rascador, PE

art.	dim. cm.	h.
42520-00	17x6	9

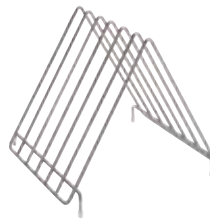

Portataglieri in filo, inox
Cutting board rack, stainless steel
Tranchierbrett-Träger, E. R.
Sechoir à planches à découper, inox
Porta tablas, inox

art.	dim. cm.	h.
42542-00	30x26	27,5



Tagliere tondo, PE
Round cutting board, PE
Tranchierbrett, rund, PE
Planche à découper, ronde, PE
Tabla de corte redonda, PE

art.	Ø cm.	h.
42535-24	24,0	1,0
42535-32	32,5	1,5
42535-49	49,0	1,5



Tagliere in polietilene HD
Cutting board, HD polyethylene
Tranchierbrett, PE HD
Planche à découper, PE HD
Tabla de corte, PE HD

art.	dim. cm.	h.
42537-40	40x30	2
42537-50	50x30	2
42537-80	80x40	2



Tagliere in polietilene HD, con fermi
Cutting board with stoppers, HD PE
Tranchierbrett mit Stiften, PE HD
Planche à découper avec arrêts, PE HD
Tabla de corte, PE HD

art.	dim. cm.	h.
42540-40	40x30	2
42540-50	50x30	2
42540-80	80x40	2



Tagliere pane, legno
Bread cutting board, wood
Brotschneidbrett, Naturholz
Planche à découper en bois
Tabla de corte, madera

art.	dim. cm.	h.	GN
42964-53	53x32,5	2	1/1
42964-60	60x40	2	



**ABBIGLIAMENTO PROFESSIONALE
TESSILE, MONOUSO, PROTETTIVO**
PROFESSIONAL WORK CLOTHING
TEXTILE, DISPOSABLE, PROTECTIVE



Grembiule cuoco
Chef apron
Chef Schurz
Tablier du chef
Mandil chef



art. dim.cm
48541-00 70x46 h.
100% cotone. - Cotton. - 185 g/mq.



Grembiule barman
Barman apron
Barman Schurz
Tablier barman
Mandil barman



art. dim.cm
48543-01 70x40 h.
65% poliestere. - Polyester.
35% cotone. - Cotton. - 195 g/mq.



Grembiule barman
Barman apron
Barman Schurz
Tablier barman
Mandil barman



art. dim.cm
48543-02 70x40 h.
65% poliestere. - Polyester.
35% cotone. - Cotton. - 195 g/mq.



Giacca cuoco, maniche corte
 Chef jacket, short sleeve
 Chef Jacke, kurz Ärmel
 Veste de chef, manche courte
 Chaqueta chef, manga corta

art.	Taglia/Size
48530-01	S
48530-02	M
48530-03	L
48530-04	XL
48530-05	XXL

100% cotone. - Cotton. - 185 g/mq.



Giacca cuoco, maniche lunghe
 Chef jacket, long sleeve
 Chef Jacke, lange Ärmel
 Veste de chef, manche longue
 Chaqueta chef, manga larga

art.	Taglia/Size
48531-02	M
48531-03	L
48531-04	XL
48531-05	XXL

100% cotone. - Cotton. - 185 g/mq.
 Incl. fazzoletto collo + set bottoni neri di ricambio. - With neckcloth + one set black spare knops.



Cappello cuoco
 Chef hat
 Chef-Kochmütze
 Chapeau de chef
 Gorro de papel pastel-cocinero

art.	48540-00
------	----------

100% cotone. - Cotton. - 185 g/mq.

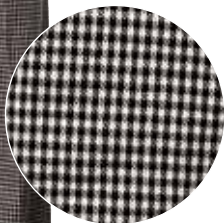

Pantaloni cuoco
 Chef trousers
 Chef Hosen
 Pantalon du chef
 Pantalones chef

art.	Taglia/Size
48536-01	42
48536-02	44
48536-03	46
48536-04	48
48536-05	50
48536-06	52
48536-07	54
48536-08	56
48536-09	58

100% cotone. - Cotton. - 185 g/mq.
 Incl. torcione. - With dish cloth.



Grembiule sommelier
 Sommelier apron
 Sommelier Schurz
 Tablier sommelier
 Delantal sommelier

art.	dim.cm
48542-01	94x100 h.

65% poliestere. - Polyester.
 35% cotone. - Cotton. - 195 g/mq.



Grembiule cameriere
 Waiter apron
 Ober Schurz
 Tablier garçon
 Delantal camarero

art.	dim.cm
48544-02	90x110 h.

100% cotone. - Cotton. - 140 g/mq.



Guanto in cotta di maglia
Chainmail glove
Fingerhandschuhe
Gant en cotte de mailles
Guante de malla

art.	taglia/size	Col.
48505-01	S	bianco/white
48505-02	M	rosso/red
48505-03	L	blu/blue

Ambidestro, in acciaio AISI 316 L, anelli saldati, ø esterno 4 mm - ø del filo 0,5 mm, cinturino nylon.
Fits either hands, made of stainless steel AISI 316 L, welded rings - external ø of the rings 4 mm - wire ø 0,5 mm, nylon strap.



Guanto lungo in cotta di maglia
Chainmail glove, extended cuff
Fingerhandschuhe, lang
Gant en cotte de mailles, manchette longue
Guante largo de malla

art.	taglia/size	Col.
48506-01	S	bianco/white
48506-02	M	rosso/red
48506-03	L	blu/blue



Grembiule di protezione
Protective apron
Schutzschürze
Tablier de protection
Delantal de protección

art.	dim. cm.
48501-76	75x55

EN ISO 13998 - Livello/Level 2
Costituito da piastrine in alluminio di dimensioni 20x19x0,8 mm collegate da anelli in acciaio inossidabile ø 1 mm. Dotato di bretelle regolabili e staccabili.
Made with aluminum plates dimensions 20x19x0,8 mm Stainless steel ring links ø 1 mm. Belt fastening with textile adjustable and detachable straps.



Guanto anti taglio
Cut resistant glove
Schnittschutz-Handschuh
Gant anti-coupures
Guante de protección

art.	taglia/size
48523-01	S
48523-02	M
48523-03	L
48523-04	XL

Guanto in fibra spectra in maglia a trama fine, resistenza al taglio livello massimo [EN388: livello 5], lavabile fino a 95°C, ambidestro. - Spectra fiber glove, fine weave knit, cut resistance maximum level [EN388: level 5], washable up to 95 °C, ambidextrous.



Guanti anticalore a 3 dita (paio)
Three-finger oven glove
Backhandschuhe, 3 Finger
Moufles protection thermique, 3 doigts
Guantes de protección

art.	l. cm.
48517-03	35,5

Resistenti all'abrasione, agli strappi ed ai tagli. Marcati CE, rispettano i requisiti essenziali di salute e sicurezza secondo le direttive europee 89/686/C.E.E. Hanno una resistenza al calore per contatto fino a 350°C per 20 secondi. - Resistant to abrasion, tears and cuts. CE marking, in accordance to the basic requirements concerning health and security of the European Directives 89/686/C.E.E. Contact heat resistant up to +350°C for 20 seconds.



Guanti da forno (paio)
Oven mitts
Backhandschuhe
Moufles de défournement
Manoplas de protección

art.	dim. cm.
48513-02	26x14,5

In cotone speciale, colore naturale, esecuzione rinforzata palmo e pollice. Resistente fino a +200°C. Lavabile in lavatrice max. 40°C. - Special cotton fabric, natural color, reinforced palm and thumb. Heat resistant up to +200°C. Machine washable up to +40°C.



Guanto da forno
Oven mitt
Ofenhandschuh
Moufle de déformement
Manopla de protección

art.	l. cm.
48510-00	27,5

Tessuto esterno 100% cotone con rivestimento argenteo 100 g/mq.
Outer fabric 100% cotton with silver coating, 100 g/mq.



Guanti da forno (paio)
Oven mitts
Backhandschuhe
Moufle de déformement
Manoplas de protección

art.	dim. cm.
48511-02	34x16

In cotone speciale, colore naturale, esecuzione rinforzata palmo e pollice. Resistente fino a +200°C. Lavabile in lavatrice max. 40°C. - Special cotton fabric, natural color, reinforced palm and thumb. Heat resistant up to +200°C. Machine washable up to +40°C.



Guanti da forno (paio)
Oven mitts
Backhandschuhe
Moufles de déformement
Manoplas de protección

art.	dim. cm.
48512-02	27x15



N

Guanti anticalore, nitrile (paio)
 Oven glove, nitrile
 Backhandschuhe, Nitril
 Moufles protection thermique, nitrile
 Guantes de protección, nitrile

art.	l. cm	taglia/size
48515-09	45	9
48515-11	45	11
48515-12	45	12

Protezione al calore da contatto fino a 150°C. Resistenza agli oli, ai grassi e ai principali detersivi. Lavabili all'interno e all'esterno. - **Contact heat protection up to 150°C. Resistance to oils, grases and main detergents. Washable inside and outside.**



Guanto da forno, silicone
 Oven mitt, silicone
 Backhandschuhe, Silikon
 Gant de protection, silicone
 Manopla de protección, silicona

art.
 48514-00

Ambidestro. Resistenza al calore per contatto fino a 300°C per 15 secondi. Stagno all'acqua e agli oli bollenti, lavabile in lavastoviglie. - **Ambidextrous. Contact heat resistant up to +300°C for 15 seconds. Non-slip, water and oil tight, dishwasher safe.**



VERDURE: Il guanto per verdure è un guanto universale. In taglia unica è ideale per pulire, lavare patate, radici, bietole, funghi, zucche/zucchine, mais e quant'altro.

VEGGIE: The veggie glove is the universal vegetable glove. The glove is a one size fits all and ideal to scrub, rinse and clean potatoes, beet roots, radices, leaks, mushrooms, gourds, corn, and many more.



Guanti scrub (paio)
 Scrubbing gloves
 Schrubben Handschuhe
 Gants à scrubbing
 Guantes para fregar

art.	taglia/size
48518-01	unica/one size



Guanti scrub (paio)
 Scrubbing gloves
 Schrubben Handschuhe
 Gants à scrubbing
 Guantes para fregar

art.	taglia/size
48518-02	unica/one size



Guanti scrub (paio)
 Scrubbing gloves
 Schrubben Handschuhe
 Gants à scrubbing
 Guantes para fregar

art.	taglia/size
48518-03	unica/one size

Non utilizzare su fonti di calore, forno, o BBQ, non mettere nel microonde. Ideonei al contatto con alimenti. Realizzati in nylon resistente ma flessibile, lavabile in lavatrice e lavastoviglie. - **It is not an oven mitt, do not use on heat, oven, BBQ or do not put it in the microwave. Food-tested. Made with durable nylon, machine-washable and dishwasher-safe.** - **PATATE:** Ideale per pulire, lavare le patate in genere, come pure molte altre verdure. - **PESCE:** Ideale per impugnare saldamente, pulire e strofinare frutti di mare e pesce, include inserto desquamante. - **POTATO:** Ideal to scrub, rinse and clean new potatoes, baked potatoes and many other vegetables. - **FISH:** A perfect aid to hold, clean and scrub seafood and fish without getting smelly fingers. Includes de-scaling patch.

Guanto monouso in nitrile. Trattamento Powder free - Peso 4,5 gr/M - Finitura Microgrip. Privo di polvere. I valori di durata sono associati ad una ottima resistenza chimica e ad una buona protezione meccanica (resistenza alla trazione e perforazione). Non contiene fattori allergizzanti essendo un prodotto Latex free. - **Disposable nitrile glove. Treatment Powder free - Weight 4,5 gr/M - Finish microgrip. Free of dust. The duration values offered by this glove are associated with a very good chemical resistance and a good mechanical protection (tensile and puncture strength). Do not contain allergens being a Latex-free product.**



Guanti in lattice (paio)
 Sugar gloves
 Zucker-Handschuhe
 Gants à tirer le sucre
 Guantes de látex

art.	T./size
48516-07	7 - 7 1/2
48516-08	8 - 8 1/2
48516-09	9 - 9 1/2



Guanti blu, nitrile
 Blue gloves, nitrile
 Blau-Handschuhe, Nitril
 Gants en nitrile, bleu
 Guantes azules, nitrile

art.	T./size	u. pack
48519-01	S	100
48519-02	M	100
48519-03	L	100
48519-04	XL	100



Guanti in polietilene HD
 Gloves, HD polyethylene
 HD Polyethylen Handschuhe
 Gants en polyéthylène HD
 Guantes de polietileno HD

art.	l. cm	u. pack
48522-24	24	500

Taglia unica, finitura palmo e dita microgrip. - **One size, palm and fingers microgrip finishing.**



Cappello Grand Chef, carta
Paper Chef hat
Kochmütze, Papier
Toque papier
Tocado, papel

art.	h. cm	u. pack
48520-20	20	20

Carta crespata doppia lavorazione, fascia assorbi sudore, adesivo regolabile, areato.
Double crepe paper processing, absorbent, adjustable size, ventilated.



Cappello Grand Chef, carta
Paper Chef hat
Kochmütze, Papier
Toque papier
Tocado, papel

art.	h. cm	u. pack
48520-23	23	20



Grembiule LDPE
Apron, LDPE
Schurz, LDPE
Tablier, LDPE
Delantal, LDPE

art.	dim. cm	u. pack
48524-75	75x120	50 15gr/m ²

Impermeabile e resistente, lunghezza 120 cm dal petto, totale 140 cm.
Waterproof and resistant, length 120 cm from the chest, total length 140 cm.



Cappello Grand Chef, carta
Paper Chef hat
Kochmütze, Papier
Toque papier
Tocado, papel

art.	h. cm	u. pack
48520-30	30	20

Carta crespata doppia lavorazione, fascia assorbi sudore, adesivo regolabile, areato. - Double crepe paper processing, absorbent, adjustable size, ventilated.



Cappello Monsieur Chef, TNT
Chef's hat, TNT
Chef-Kochmütze, tnt
Toque plisée chef, TNT
Gorro Chef, TNT

art.	u. pack
48529-00	20

Tnt-polipropilene, plissettato, fascia assorbi sudore, adesivo regolabile per fissare la taglia. - Tnt-polypropylene, pleated, band absorb sweat, adjustable adhesive to fix the size.



Bustina carta
Paper cap
Papier Mütze
Calot papier
Gorro barco papel

art.	u. pack
48528-00	100

Carta doppia lavorazione, fascia assorbi sudore, adesivo regolabile, aerata.
Double paper processing, absorbent, adjustable size, ventilated.



Cuffia, TNT
Cap, TNT
Einweghauben, TNT
Charlotte, TNT
Cubrecabezas, TNT

art.	u. pack
48527-00	100

Cuffia plissettata TNT 16gr/m², molto leggera, morbido elastico, ø 50 cm.
Pleated cap, TNT 16gr/m², very light, soft elastic, ø 50 cm.



Kit visitatore, TNT
Visitor kit, TNT
Besucher-Kits, TNT
Kit visiteur, TNT
Conjunto visitador, TNT

art.
48525-03

Composta da 1 camice e cuffia in TNT e 1 set copriscarpe CPE. - Composed: 1 TNT overall and cap, 1 CPE overshoes.



Copriscarpe, PE
Overshoes, PE
Überschuhe, PE
Sur-chaussures, PE
Cubrezapatos, PE

art.	l. cm	u. pack
48526-44	44	110

PE doppio spessore, impermeabili, elastico alla caviglia, fondo gofrato.
PE double-thickness, waterproof, elastic ankle, embossed bottom.

STORAGE & TRANSPORT

STOCCAGGIO E TRASPORTO
STORAGE & TRANSPORT
LAGERUNG UND TRANSPORT
STOCKAGE & TRANSPORT
ALMACENAMIENTO Y TRANSPORTE

SERIE 14000

CESTELLI
WASHRACKS



Realizzati in polipropilene, stampati unipezzo a doppio spessore. Resistenti agli urti ed alte temperature, agenti chimici e residui alimentari. Concepiti per assicurare una protezione ottimale a bicchieri e stoviglie, il loro design permette inoltre una perfetta circolazione dell'acqua di lavaggio ed una rapida e perfetta asciugatura. Facili e veloci da impilare. Leggeri e maneggevoli, tutti i cestelli di base sono dotati di maniglie integrali su tutti i lati.

214

Molded in one-piece with double-wall construction made of polypropylene. Resistant to shock, high temperatures and chemicals. Designed to give optimum protection to glass and chinaware as well as to maximise water circulation and drying in professional dishwasher. Easy and quickly stackable without tools or screws. Base racks have comfortable hand grips on all four sides facilitating handling.



Cestello 9 bicchieri
9-Compartment base
Grundkorb für 9 Gläser
Panier de base 9 verres
Cesta 9 compartimentos

art.	dim. mm.	h.
14001-09	500x500	103
Scomparti/Compartments 151x151x88 ø max 151 mm.		



Estensore per cestello 9 bicchieri
9-Compartment extender
Aufsatz zum Grundkorb für 9 Gläser
Réhausse pour panier de base 9 verres
Extensión 9 compartimentos

art.	dim. mm.	h.
14003-09	500x500	45
Scomparti/Compartments 151x151x42 ø max 151 mm.		



Cestello 16 bicchieri
16-Compartment base
Grundkorb für 16 Gläser
Panier de base 16 verres
Cesta 16 compartimentos

art.	dim. mm.	h.
14001-16	500x500	103
Scomparti/Compartments 112x112x88 ø max 112 mm.		



Estensore per cestello 16 bicchieri
16-Compartment extender
Aufsatz zum Grundkorb für 16 Gläser
Réhausse pour panier de base 16 verres
Extensión 16 compartimentos

art.	dim. mm.	h.
14003-16	500x500	45
Scomparti/Compartments 112x112x42 ø max 112 mm.		



Cestello 25 bicchieri
25-Compartment base
Grundkorb für 25 Gläser
Panier de base 25 verres
Cesta 25 compartimentos

art.	dim. mm.	h.
14001-25	500x500	103
Scomparti/Compartments 88x88x88 ø max 88 mm.		



Estensore per cestello 25 bicchieri
25-Compartment extender
Aufsatz zum Grundkorb für 25 Gläser
Réhausse pour panier de base 25 verres
Extensión 25 compartimentos

art.	dim. mm.	h.
14003-25	500x500	45
Scomparti/Compartments 88x88x42 ø max 88 mm.		



Cestello 36 bicchieri
36-Compartment base
Grundkorb für 36 Gläser
Panier de base 36 verres
Cesta 36 compartimentos

art.	dim. mm.	h.
14001-36	500x500	103
Scomparti/Compartments 73x73x88 ø max 73 mm.		



Estensore per cestello 36 bicchieri
36-Compartment extender
Aufsatz zum Grundkorb für 36 Gläser
Réhausse pour panier de base 36 verres
Extensión 36 compartimentos

art.	dim. mm.	h.
14003-36	500x500	45
Scomparti/Compartments 73x73x42 ø max 73 mm.		



Cestello 49 bicchieri
49-Compartment base
Grundkorb für 49 Gläser
Panier de base 49 verres
Cesta 49 compartimentos

art.	dim. mm.	h.
14001-49	500x500	103
Scomparti/Compartments 62x62x88 ø max 62 mm.		



Estensore per cestello 49 bicchieri
49-Compartment extender
Aufsatz zum Grundkorb für 49 Gläser
Réhausse pour panier de base 49 verres
Extensión 49 compartimentos

art.	dim. mm.	h.
14003-49	500x500	45
Scomparti/Compartments 62x62x42 ø max 62 mm.		



Estensore aperto
Open extender
Universalrand ohne Einteilung
Réhausse sans cloisons
Extensión abierta

art.	dim. mm.	h.
14004-00	500x500	42



Coperchio per cestelli
Rack cover
Deckel für Körbe
Couvercle à panier
Tapa para cestas

art.	dim. mm.	h.
14011-00	505x505	25



Cestello universale
Open rack
Universal-Korb
Panier universel
Cesta universal

art.	dim. mm.	h.
14010-00	500x500	103



Cestello per posate
Cutlery rack
Besteckkorb
Panier à couverts
Cesta para cubiertos

art.	dim. mm.	h.
14006-00	500x500	103



Cestello per piatti e vassoi
Plates & trays rack
Tablett- u. Tellerkorb mit Fingern
Panier à plateaux et assiettes
Cesta para bandejas y platos

art.	dim. mm.	h.
14008-00	505x505	103

Per 18 piatti piani oppure 9 vassoi max. 460 mm. - For 18 flat plates or 9 trays max. 460 mm.



Cestello per vassoi, aperto
Tray rack, open
Tablettkorb mit Fingern, offen
Panier à plateaux, ouvert
Cesta abierto para bandejas

art.	dim. mm.	h.
14007-00	500x500	103

Per vassoi oltre 460 mm. Cap. 9 pezzi.
For trays over 460 mm. Capacity 9 pieces.



Etichette di identificazione
Clip tags
Markierungsklipp
Clips
Etiquetas

art.	dim. mm.	pz. / pcs
14013-00	80x40	10



Cestello per posate 8 scomparti
Cutlery holder 8 compartments
Besteckkorb, 8 Unterteilungen
Panier à couverts 8 compartiments
Cesta para cubiertos

art.	dim. mm.	h.
14015-08	426x206	150

Per 200/250 posate.
For 200/250 pcs cutlery.



Recipiente, polipropilene
Multipurpose box, polypropylene
Behälter, Polypropylen
Conteneur multiservice, PP
Contenedor, PP

art.	dim. cm.	h.
42585-06	54x33	13



Cestello porta posate, inox
Cutlery holder, stainless steel
Besteckbehälter, Edelstahl Rostfrei
Réipient à couverts, inox
Cestillo para cubiertos, inox

art.	Ø cm.	h.
42586-10	10	14



Cestello porta posate, polietilene
Cutlery holder, polyethylene
Besteckbehälter, Polyäthylene
Réipient à couverts, poliéthylène
Cestillo para cubiertos, PE

art.	Ø cm.	h.
42586-09	9,5	13,5



Porta posate, inox
Cutlery dispenser, stainless steel
Besteckbehälter, Edelstahl Rostfrei
Réipient à couverts, inox
Contenedor para cubiertos, inox

art.	dim. cm.	h.
42587-04	26x30	20



Porta posate, polietilene
Cutlery box, polyethylene
Besteckbehälter, Polyäthylene
Ramasse-couverts, polyéthylène
Contenedor para cubiertos, PE

art.	dim. cm.	h.
42585-04	GN 1/1	10



Coperchio per porta posate, PP
Cutlery box lid, PP
Deckel für Besteckbehälter, PP
Couvercle pour ramasse-couverts, PP
Tapa para contenedor cubiertos, PP

art.	dim. cm.	h.
42585-00	32,5x53	2



Carrello con maniglione
Dolly with handle
Transportwagen mit Griff
Chariot avec poignée
Carretilla con manillar

art.	dim. cm.	h.	Kg.
44023-00	54x54	76	10

Base in PP. - Polypropylene base.



Carrello senza maniglione
Dolly without handle
Transportwagen ohne Griff
Chariot sans poignée
Carretilla sin manillar

art.	dim. cm.	Kg.
44024-00	54x54	8,5

Base in PP. - Polypropylene base.



Carrello con maniglione, inox
Dolly with handle, stainless steel
Transportwagen mit Griff, E. R.
Chariot avec poignée, inox
Carretilla con manillar, inox

art.	dim. cm.	carico/load
44025-50	55x55x9	kg 60

Manico estraibile, tappo di scarico.
Removable handle, with drip and drain plug.



Copertura protettiva
Dust cover
Schutzhülle
Housse de protection
Cubierta protectora

art.	dim. cm.	h.
44009-00	55x55	122



Carrello porta cestelli, inox
Washrack trolley, stainless steel
GläserKörbe-Wagen, Edelstahl R.
Chariot pour casiers à vaisselle, inox
Carro para cestas vajillas, inox

art.	dim. cm.	h.
44020-21	100x50	178,5

3 livelli carico verticale, 24 cestelli.
3 levels, suitable for 24 racks.



Carrello, inox
Dolly, stainless steel
Transportwagen, Edelstahl Rostfrei
Chariot, inox
Carro, inox

art.	dim. cm.
44975C50	51x51



Recipiente, PP
Multipurpose box, PP
Behälter, PP
Conteneur multiservice, PP
Contenedor, PP

art.	dim. cm.	h.
44031-04	52x39	12,7
44031-05	52x39	17,7



Scolapiatti a muro, inox
Wall draining rack, stainless steel
Wand-Trockengestell, Edelstahl Rostfrei
Egouttoir au mur, inox
Escurridor mural de platos, inox

art.	dim. cm.	carico/load
44029-00	87x30x20	kg 70



Porta piatti in filo metallo/rilsan
Wire dish rack
Tellergestell
Porte-assiettes
Porta platos

art.	Ø cm.	h.
44047-17	17	30
44047-19	19	30
44047-22	22	30
44047-25	25	30
44047-28	28	30



Carrello portapiatti, inox
Dish dolly, stainless steel
Teller-Transportwagen, Edelstahl Rostfrei
Chariot porte-assiettes, inox
Carro porta platos, inox

art.	dim. cm.	h.	Carico/load max kg.
44027-00	74x61	81	240

Costruzione in acciaio inox. Arcata in tubo 25x25 mm. 4 ruote girevoli ø 125 mm. di cui 2 con freno, in gomma non tracciante, calotta in poliammide. Fornito con 2 griglie di separazione/anti-caduta regolabili, in filo inox ø 6 mm. Per piatti fino a ø 290 mm. - Stainless steel construction. Side rail tube 25x25 mm. 4 swivel casters ø 125 mm. 2 with brake, non-tracing rubber, cap made of polyamide. Supplied with 2 adjustable separation grids, stainless steel wire ø 6 mm. For dishes up to ø 290 mm.



Carrello portapiatti regolabile, PE
Adjustable dish dolly, PE
Teller-Transportwagen, einstellbar, PE
Chariot de stockage d'assiettes réglable, PE
Carro ajustable para platos, PE

art.	dim. cm.	h.	kg.
49304-06	73x73	81,5	28

Carrello fornito con copertura vinilica e 4 divisori. Per piatti ø cm 16-32, capienza 180/400 pezzi.
Each cart is delivered with dust cover and 4 dividers.
Dishes ø cm 16-32, capacity 180/400 pcs.



SCUOLE/SCHOOLS - OSPEDALI/HOSPITALS - RESIDENCE - CATERING

Vasellame in policarbonato. Riduce considerevolmente il peso, è impilabile e infrangibile. Sopporta temperature tra i -30°C ed i +120°C. Adatto a lavastoviglie e microonde. - Polycarbonate holloware considerably reduces weight, is unbreakable and stackable. Can withstand temperatures between -30°C and +120°C. Dishwasher and microwave safe.



BASE + COPERCHIO
BASE + LID

Vassoio isotermico, PP
Isothermic tray, PP
Thermo-Tablett, PP
Plateau isotherme, PP
Bandeja isotérmica, PP

art.	dim. cm.	h.
44871-00	57x37	11

Stoviglie escluse, vedi pagina seguente. Dishes not included, see next page. Bordi rotondi ed angoli a norma, senza spigoli. Interno isolante in poliuretano. Può accogliere stoviglie in porcellana o in PC. Coperchio e vassoio sono tra loro impilabili. Incavo laterale per l'inserimento di una etichetta. - Rounded edges smooth form and non sharp corners with insulating polyurethane interior. Both polycarbonate and chinaware may be used with the tray. Both bases and covers are stackable. A card holder can be fixed to the side of the tray to indicate the username and their diet.





Piatto piano, PC
Flat plate
Teller, flach
Assiette plate
Plato llano

art. 44871-01 Ø cm. 23,3



Piatto piano frutta, PC
Flat plate
Teller, flach
Assiette plate
Plato llano para fruta

art. 44871-02 Ø cm. 20,6 h. 3



Piatto fondo, PC
Soup plate
Suppenteller
Bol à soupe
Plato hondo

art. 44871-03 Ø cm. 18,5 h. 5

Su richiesta/On demand
MOQ 50 pz/pcs



Coperchio ermetico PP
Hermetic cover
Hermetische Abdeckung für 44871-03
Couvercle hermétique
Tapa hermética

art. 44871-04 Ø cm. 19 per/for art. 44871-03



Bolo, PC
Bowl
Schüssel
Bol
Tazón

art. 44871-06 Ø cm. 12,5 h. 6



Bolo isotermico, PC
Insulated bowl
Isolierschüssel
Bol isotherme
Tazón isotérmico

art. 44871-07 Ø cm. 12,5 h. 7,5



Coperchio ermetico per bolo, PP
Bowl hermetic lid
Hermetische Deckel für Schüssel
Couvercle hermétique pour bol
Tapa hermética para tazón

art. 44871-08 Ø cm. 13 per/for art. 44871-06/-07



Terrina, PC
Rectangular bowl
Rechteckige Schüssel
Ravier rectangulaire
Fuente rectangular

art. 44871-09 dim. cm. 13,8x9,5 h. 4,5



Tazza caffè, PC
Coffee cup
Kaffeetasse
Tasse à café
Taza café

art. 44871-13 Ø cm. 9,4 h. 6,8 cc. 325



Bicchieri acqua, PC
Water tumbler, PC
Wasserglas, PC
Verre à eau, PC
Vaso agua, PC

art.	Ø cm.	h.	ml.	u. pack
44871-20	7,0	7,0	170	10
44871-21	7,0	10,2	250	10
44871-22	7,8	11,4	350	10

Impilabile. - Stackable.

Su richiesta/On demand
MOQ 50 pz/pcs



Coperchio con beccuccio, PP
Cover with spout, PP
Deckel mit Ausguss, PP
Couvercle avec bec, PP
Tapa con boquilla, PP

art. 44871-23 Ø cm. 7 u. pack 50

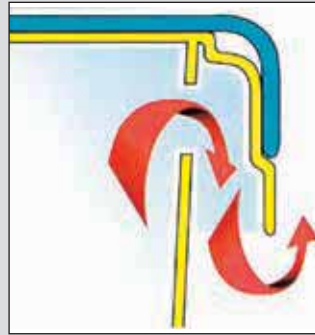

Contenitori in polipropilene trasparente per alimenti. Estremamente resistenti alle sollecitazioni, offrono protezione sicura nel trasporto. Dimensioni adatte a EURO-pallets. Adatti al lavaggio in lavastoviglie, design studiato per consentire il defluire dell'acqua. Coperchi di colore diverso facilitano l'individuazione del contenuto. Impilabili, a pieno la loro robustezza consente un'elevata capacità di sovrapposizione. Fessure di aerazione per un costante ricambio d'aria.

Clear polypropylene construction, full compliance with food contact requirements. A removable tower insert provides total flexibility. Strong, it prevents dish breakage in transport. Dimensions suitable to EURO-pallets. Lids are tightly fitting, hygienic, dish-washer safe. Covers available in different colors, assure easy and quick content identification. Stackable once empty, their strongness provides high loading density once full. Ventilation holes assure constant air circulation. Design studied to enable water flow while washing.



Contenitore, polipropilene
Polypropylene box
Korb, Polypropylen
Panier en polypropylène
Contenedor en polipropilene

Fondo piatto
Base insert
Flach-Einsatz
Plateau double fond
Base plana

Inserto croce
Cross insert
Kreuz-Einsatz
Cloison à croix
Separador a cruz

art.	dim. cm.	h. cm.	lt.
44040-40	40x40	31,5	32

art.	dim. cm.
44042-00	40x40

art.	dim. cm.
44043-00	40x40



Coperchio, polipropilene
Polypropylene cover
Deckel, Polypropylen
Couvercle en polypropylène
Tapa en polipropilene

Coperchio, polipropilene
Polypropylene cover
Deckel, Polypropylen
Couvercle en polypropylène
Tapa en polipropilene

Tubo fermapiatti
Tower insert
Rohr-Einsatz
Tuyau
Tubo

art.	colore/color
44041-00	trasparente/clear
44041-01	giallo/yellow
44041-03	rosso/red

art.	colore/color
44041-04	blu/blue
44041-05	verde/green

art.
44044-00

CONTENITORI QUADRATI - SQUARE CONTAINERS



Contenitori impilabili. Disponibili in un copoliestere alternativo privo di bisfenolo A (BPA free) trasparente per identificare il contenuto o in resistente polietilene bianco. Graduati: rosso USA e blu per i litri. Impugnature resistenti per un trasporto più pratico e fori di drenaggio per il lavaggio e un'asciugatura accurata. I contenitori in copoliestere resistono a temperature comprese fra i -40°C e i 100°C. I contenitori in polietilene resistono a temperature comprese fra i -28°C e i 65°C. Lavabili in lavastoviglie. Coperchi con linguetta con chiusura ermetica a pressione. Disponibili in due misure adattabili a tutti i contenitori.

Square stackable containers. Available in clear copolyester (BPA-free) for visibility or in white polyethylene. Smooth surfaces for easy cleaning. Precise measurement gradations in red/blue. User-friendly, easy-grip handles with dishwasher drain hole. Nest for compact storage. Temperature range, copolyester containers: -40°C to 100°C. Temperature range, polyethylene containers: -28°C to 65°C. Dishwasher safe. Tight-fitting lids with flap. Available in two sizes to fit all containers.



Contenitore per alimenti, copoliestere
Food container, copolyester
Vorratsdosen, Copoliéster
Conteneur pour aliments, copolyester
Contenedor para alimentos, copolyester

art.	dim. cm.	h.	lt.
44620-01	22,2x21,1	6,8	1,9
44620-02	22,2x21,1	12,1	3,8
44620-03	22,2x21,1	17,6	5,7
44620-04	22,2x21,1	22,2	7,6
44620-05	28,7x26,7	19,7	11,4
44620-06	28,7x26,7	30,3	17,0
44620-07	28,7x26,7	36,7	20,8

Contenitore per alimenti, PE
Food container, PE
Vorratsdosen, PE
Conteneur pour aliments, PE
Contenedor para alimentos, PE

art.	dim. cm.	h.	lt.
44624-03	22,2x21,1	17,6	5,7
44624-04	22,2x21,1	22,2	7,6
44624-05	28,7x26,7	19,7	11,4
44624-06	28,7x26,7	30,3	17,0
44624-07	28,7x26,7	36,7	20,8

Coperchio, PE
Lid, PE
Deckel, PE
Couvercle, PE
Tapa, PE

art.	dim. cm.
44620-14	22,2x21,1
44620-17	28,7x26,7

CONTENITORI ROTONDI - ROUND CONTAINERS



La forma tonda permette una migliore circolazione dell'aria per la conservazione in frigorifero o congelatore. Impilabili con maniglie, in polipropilene trasparente. Resistono a temperature comprese fra i -28°C e i 65°C. Lavabili in lavastoviglie. I coperchi sono a chiusura ermetica con doppia barriera e linguetta di apertura nell'angolo. Consentono l'indicazione della data e del contenuto in un'apposita area di scrittura. Disponibili in due misure adattabili a tutti i contenitori.

In clear polypropylene. Stackable. Nest for compact storage. Reinforced rim for added strength. User-friendly, easy grip handles with dishwasher drain hole. Temperature range: -28°C to 65°C. Dishwasher safe. Tight-fitting lids with double barrier and opening flap in the corner. Writing area on the cover to specify date and content. Available in two sizes to fit all containers.



Contenitore per alimenti, PP
Food container, PP
Vorratsdosen, PP
Conteneur pour aliments, PP
Contenedor para alimentos, PP

art.	ø cm.	h.	lt.
44625-04	25,4	27,0	7,6
44625-05	33,3	20,6	11,4
44625-06	33,3	30,2	17,0
44625-07	33,3	35,6	20,8
44625-08	33,3	35,6	20,8

Con manico / With handle

Coperchio, PE
Lid, PE
Deckel, PE
Couvercle, PE
Tapa, PE

art.	ø cm.	h.
44625-26	26,0	2,5
44625-34	34,3	3,2

Il Sistema del codice colore per il settore della ristorazione permette di proteggere i propri clienti dai pericoli di malattie e allergeni dovuti al cibo. Previene la contaminazione crociata durante la conservazione di diversi tipi di alimenti. Utilizzate i contenitori e i coperchi con codice colore per tenere separati i cibi non cotti, come la carne cruda, dagli alimenti pronti da consumare. - **The Color-Coded Foodservice System enables users to protect their patrons from food borne illnesses and allergens. Prevents cross contamination when storing different types of food. Use colour-coded storage containers and lids to keep uncooked foods like raw meat separate from ready-to-eat foods.**

QUADRATI E ROTONDI, IN 3 DIMENSIONI, IN 7 COLORI. - **ROUND AND SQUARE, AVAILABLE IN 3 SIZES AND IN 7 COLORS.**



CARNE CRUDA
RAW MEAT



PESCE CUDDO
RAW FISH



CARNE COTTA
COOKED MEAT



ALLERGENI
ALLERGENS



FRUTTA/INSALATA
FRUIT/SALAD



VERDURE
VEGETABLES



LATTICINI
DAIRY

CONTENITORI QUADRATI - SQUARE CONTAINERS



In policarbonato perfettamente trasparente. Impugnature resistenti e fori di drenaggio. Intervallo termico: da -40°C a 100°C. Impilabili, con tacche graduate. Coperchi ermetici in Polietilene con chiusura a pressione. Linguette angolari per rimuovere agevolmente il coperchio. Lavabili in lavastoviglie.

In crystal-clear polycarbonate. Durable handles and drain holes. Temperature range: -40° to 100°C. Stackable with easy to read measurement graduations. Leak-resistant, Polyethylene snap-tight lids. Corner pull tabs for easy lid removal. Commercial dishwasher safe.

	Lt.	Dim. cm.	Bianco White	Rosso Red	Verde Green	Blu Blue	Giallo Yellow	Viola Violet	Marrone Brown
Contenitore quadrato Square container	3,8	23,14x22,34x11,94	44626W04	44626R04	44626G04	44626B04	44626Y04	44626V04	44626M04
Contenitore quadrato Square container	7,6	23,14x22,34x22,20	44626W08	44626R08	44626G08	44626B08	44626Y08	44626V08	44626M08
Contenitore quadrato Square container	11,4	29,48x28,87x19,69	44626W11	44626R11	44626G11	44626B11	44626Y11	44626V11	44626M11
Coperchio/Lid	3,8/7,6		44620-14	44620R14	44620G14	44620B14	44620Y14	44620V14	44620M14
Coperchio/Lid	11,4		44620-17	44620R17	44620G17	44620B17	44620Y17	44620V17	44620M17

CONTENITORI ROTONDI - ROUND CONTAINERS



In polipropilene semitrasparente. Intervallo termico: da 2°C a 66°C. Impilabili. Tacche di misurazione. Impugnature resistenti e fori di drenaggio. Coperchi in polietilene a chiusura ermetica (a doppia guarnizione) e linguette per il sollevamento. Lavabili in lavastoviglie.

In semi-clear polypropylene. Temperature range: from 2°C to 66°C. Stackable. Easy to read graduation marks. Secure, leak-resistant polyethylene lids (double-wall seal) with pull tabs. Commercial dishwasher safe.

	Lt.	Dim. cm.	Bianco White	Rosso Red	Verde Green	Blu Blue	Giallo Yellow	Viola Violet	Marrone Brown
Contenitore rotondo Round container	3,8	ø 23,21x19,56	44627W04	44627R04	44627G04	44627B04	44627Y04	44627V04	44627M04
Contenitore rotondo Round container	7,6	ø 28,28x26,86	44627W08	44627R08	44627G08	44627B08	44627Y08	44627V08	44627M08
Contenitore rotondo Round container	11,4	ø 37,08x20,51	44627W11	44627R11	44627G11	44627B11	44627Y11	44627V11	44627M11
Coperchio/Lid	3,8		44625W20	44625R20	44625G20	44625B20	44625-20	44625V20	44625M20
Coperchio/Lid	7,6		44625W26	44625R26	44625G26	44625B26	44625-26	44625V26	44625M26
Coperchio/Lid	11,4		44625W34	44625R34	44625G34	44625B34	44625-34	44625V34	44625M34



Contenitore per alimenti
Food container
Nahrungsmittel-Behälter
Conteneur pour aliments
Contenedor para alimentos

art.	dim. cm.	h.	lt.
49384-03	45,7x30	22,9	19,0
49384-04	45,7x66	8,9	19,0
49384-05	45,7x66	15,0	32,3
49384-06	45,7x66	23,0	47,0
49384-07	45,7x66	38,0	81,5



Vasca di drenaggio
Drain tray
Abtropf-Behälter
Conteneur perforé
Contenedor para colar

art.	dim. cm.	h.
49384-11	45,7x66	12



Coperchio
Lid
Deckel
Couvercle
Tapa

art.	dim. cm.	da/a - from/to
49384-14	45,7x30	7,6 → 19 lt.
49384-15	45,7x66	32,2 → 81,5 lt.



Contenitore per alimenti, PP
Food container, PP
Nahrungsmittel-Behälter, PP
Conteneur pour aliments, PP
Contenedor para alimentos, PP

art.	dim. cm.	h.	lt.
49382-10	30x30	21,6	10,0
49382-23	60x29	43,0	23,5
49382-47	60x49	43,0	47,0



Carrello per derrate alimentari, PP
Storage container, PP
Fahrbares Nahrungsmittelbehälter, PP
Chariot mobile de stockage, PP
Contenedor para hortalizas, PP

art.	dim. cm.	h.	lt.
49381-01	74x33,5	71	79,0
49381-02	75x39,5	71	97,5
49381-03	75,5x45,5	71	116,0



Contenitore tondo, PE
Container, round, PE
Behälter, Rund, PE
Conteneur, rond, PE
Contenedor redondo, PE

art.	ø cm.	h.	lt.
49373-01	39,7	43,5	37,9
49373-02	49,5	58,1	75,7
49373-03	55,9	69,2	121,1
49373-04	67,3	83,8	208,2



Coperchio tondo, PE
Lid, round, PE
Deckel, Rund, PE
Couvercle, rond, PE
Tapa redonda, PE

art.	ø cm.	h.
49373-11	40,6	2,5
49373-12	50,5	3,2
49373-13	56,5	3,5
49373-14	67,9	5,1



Contenitore quadrato, PE
Container, square, PE
Behälter, viereckig, PE
Conteneur carré, PE
Contenedor cuadrado, PE

art.	dim. cm.	h.	lt.
49374-01	54,6x54,6	57,2	106,0
49374-02	59,7x59,7	73,0	151,4



Coperchio quadrato, PE
Lid, square, PE
Deckel, viereckig, PE
Couvercle carré, PE
Tapa cuadrada, PE

art.	dim. cm.	h.
49374-11	56x56	5,1
49374-12	61x61	5,1



Supporto mobile, PE
Dolly, PE
Wagen, PE
Chariot, PE
Soporte móvil, PE

art.	dim. cm.	h.	carico/load
49373-90	∅ 46,4	16,8	kg. 113,4
49374-90	44x44	16,0	kg. 113,4



Cesta pane impilabile, polietilene
Bread basket, stackable, LLDPE
Brot-Korb, stapelbar, LLDPE
Corbeille à pain, empilable, LLDPE
Cesta pan, apilable, LLDPE

art.	dim. cm.	h.	lt.
44982-04	57x36	34	40
44982-06	66x45	35	60
44982-10	78x52	40	100



Carrello vasca, inox
Sink trolley, stainless steel
Obst/Gemüsewaschwagen, Edelstahl Rostfrei
Chariot à evier, inox
Carro-cuba lavado verduras, inox

art.	dim. cm.	h.
44028-00	86x66	100

Con 4 ruote pivotanti di cui 2 con freno.
4 swivel casters, 2 with brakes.



Contenitore con coperchio
Space saving box with cover
Behälter mit Deckel
Récepteur avec couvercle
Contenedor con tapa

art.	dim. cm.	h.
44033-23	66x45	23
44033-38	67x46	38

Sovrapponibile e impilabile.
Stackable and nestable.



Cesto gastronorm, PP
Gastronorm basket, PP
Gastronorm-Korb, PP
Panier gastronorme, PP
Cesta gastronorm, PP

art.	dim. cm.	h.
44034-11	59x39	19,5

Impilabile. - Stackable.



Contenitore sovrapponibile, HDPE
Stackable container, HDPE
Behälter, stapelbar, HDPE
Conteneur empilable, HDPE
Contenedor apilable, HDPE

art.	dim. cm.	h.	lt.
44511E21	60x40	10	21
44511E63	60x40	32	63
44511E90	60x40	45	90

Fondo e pareti chiuse.
Solid bottom and sides.



Contenitore sovrapponibile, HDPE
Stackable container, HDPE
Behälter, stapelbar, HDPE
Conteneur empilable, HDPE
Contenedor apilable, HDPE

art.	dim. cm.	h.	lt.
44512E12	60x40	7	12
44512E21	60x40	10	21

Fondo chiuso e pareti forate.
Solid bottom and perforated sides.



Contenitore sovrapponibile, HDPE
Stackable container, HDPE
Behälter, stapelbar, HDPE
Conteneur empilable, HDPE
Contenedor apilable, HDPE

art.	dim. cm.	h.	lt.
44513E12	60x40	7	12
44513E21	60x40	10	21

Fondo e pareti forate.
All perforated.



Coperchio, polipropilene
Lid, PP
Deckel, PP
Couvercle, PP
Tapa, PP

art.	dim. cm.	h.
41763-00	60x40	2



Coperchio, polipropilene
Lid, PP
Deckel, PP
Couvercle, PP
Tapa, PP

art.	dim. cm.	h.
41763-30	40x30	2



Contenitore sovrapponibile, HDPE
Stackable container, HDPE
Behälter, stapelbar, HDPE
Conteneur empilable, HDPE
Contenedor apilable, HDPE

art.	dim. cm.	h.	lt.
44521E10	40x30	12	10

Fondo e pareti chiuse.
Solid bottom and sides.



Contenitori sovrapponibili con dimensioni esterne di mm 600 x 400 e 400 x 300 perfettamente pallettizzabili su pallet EUR mm 800 x 1200 e 1000 x 1200. Disponibili in diverse altezze e versioni. Polietilene alta densità HDPE. Uno dei materiali termoplastici più dotato di resistenza all'impatto con basse temperature (da -30°C a +70°C).

Stackable containers, external dimensions 600 x 400 mm and 400 x 300 mm, they perfectly fit to 800 x 1200 mm EUR pallets and to 1000 x 1200 mm. Available in different heights and versions. High density polyethylene HDPE. A thermoplastic that offers excellent impact resistance at low temperatures (from -30°C to +70°C).



Contenitore sovrapponibile, HDPE
Stackable container, HDPE
Behälter, stapelbar, HDPE
Conteneur empilable, HDPE
Contenedor apilable, HDPE

art.	dim. cm.	h.	lt.
44521-16	40x30	17	16
44521-21	40x30	22	21
44521-31	40x30	32	31

Fondo e pareti chiuse.
Solid bottom and sides.

Contenitore sovrapponibile, HDPE
Stackable container, HDPE
Behälter, stapelbar, HDPE
Conteneur empilable, HDPE
Contenedor apilable, HDPE

art.	dim. cm.	h.	lt.
44511-27	60x40	15	27
44511-34	60x40	17	34
44511-38	60x40	20	38
44511-42	60x40	22	42
44511-63	60x40	32	63
44511-90	60x40	45	90

Fondo e pareti chiuse.
Solid bottom and sides.



Contenitore sovrapponibile, HDPE
Stackable container, HDPE
Behälter, stapelbar, HDPE
Conteneur empilable, HDPE
Contenedor apilable, HDPE

art.	dim. cm.	h.	lt.
44522E10	40x30	12	10

Fondo chiuso e pareti forate.
Solid bottom and perforated sides.



Contenitore sovrapponibile, HDPE
Stackable container, HDPE
Behälter, stapelbar, HDPE
Conteneur empilable, HDPE
Contenedor apilable, HDPE

art.	dim. cm.	h.	lt.
44522-16	40x30	17	16
44522-21	40x30	22	21
44522-31	40x30	32	31

Fondo chiuso e pareti forate.
Solid bottom and perforated sides.



Contenitore sovrapponibile, HDPE
Stackable container, HDPE
Behälter, stapelbar, HDPE
Conteneur empilable, HDPE
Contenedor apilable, HDPE

art.	dim. cm.	h.	lt.
44512-34	60x40	17	34
44512-42	60x40	22	42
44512-63	60x40	32	63
44512-90	60x40	45	90

Fondo chiuso e pareti forate.
Solid bottom and perforated sides.



Contenitore sovrapponibile, HDPE
Stackable container, HDPE
Behälter, stapelbar, HDPE
Conteneur empilable, HDPE
Contenedor apilable, HDPE

art.	dim. cm.	h.	lt.
44513-34	60x40	17	34
44513-38	60x40	20	38
44513-54	60x40	29	54
44513-63	60x40	32	63
44513-90	60x40	45	90

Fondo e pareti forate.
All perforated.

+ OPTIONAL

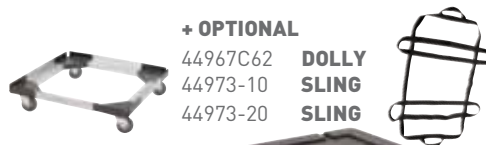

44967C62 **DOLLY**
44973-10 **SLING**
44973-20 **SLING**



Contenitore isotermico GN 1/2
Insulated box 1/2 GN
GN 1/2-Thermobehälter
Conteneur isotherme GN 1/2
Contenedor isotérmico GN 1/2

art.	cm. ext.	cm. int.
44972-20	41,5x32x28,5	35x27x21,5
44972-25	41,5x32x32	35x27x25
44972-33	41,5x32x40	35x27x33



Contenitore isotermico GN 1/1
Insulated box 1/1 GN
GN 1/1-Thermobehälter
Conteneur isotherme GN 1/1
Contenedor isotérmico GN 1/1

art.	cm. ext.	cm. int.
44970-10	60x40x17	54x34x11
44970-15	60x40x23	54x34x17
44970-20	60x40x27	54x34x21
44970-34	60x40x34,5	54x34x28



Contenitore isotermico PLUS GN 1/1
Insulated box
Thermobehälter
Conteneur isotherme
Contenedor isotérmico

art.	cm. ext.	cm. int.
44978-10	68x44,5X20	56x37x12
44978-20	68x44,5X30	56x37x22

Il polipropilene è un materiale idoneo per il contatto con sostanze alimentari. Non cede odori e sapori anomali agli alimenti ed è facilmente lavabile e sanificabile dopo il suo utilizzo. I contenitori isotermici sono ideali per proteggere gli alimenti da sollecitazioni di tipo meccanico grazie allo spessore ed alla struttura a cellula chiusa; sono leggeri e privi di sporgenze e spigoli vivi per tutelare la sicurezza degli operatori durante le operazioni di movimentazione e trasporto. Resistenti, igienici, ecologici e riciclabili al 100%, sono compatibili al lavaggio e alla disinfezione industriale con detergenti e disinfettanti, acqua calda e vapore umido fino alla temperatura di 110°C (HAACCP System). Sono idonei a proteggere gli alimenti da sollecitazioni termiche grazie alle proprietà coiberanti del polimero espanso il quale possiede un coefficiente di resistività (Lambda) di 0,039 W/mk e garantisce una caduta termica di 1,5-2,5°C/H/contenitore.

The polypropylene is certified as material suitable for contact with food. It does not hand over odours or flavours to foods and it is easy to wash and disinfect after use. The isothermal containers, entirely made of closed-cell expanded polypropylene, are ideal to protect food from mechanical stresses; they are light and free of protrusions and sharp edges in order to guarantee the operators' safety during handling and transport operations. They are resistant, hygienic, economic, 100% recyclable, suitable for industrial washing and disinfection with detergents and disinfectants, hot water, and wet vapour up to a temperature of 110°C (HACCP System). These containers are suitable to protect food thermal stresses thanks to the insulating properties of the expanded polymer which has a resistivity coefficient (Lambda) of 0.039 W/mk and guarantees a thermal loss of 1.5-2.5°C/H/container.

CURVA DELLA TEMPERATURA
TEMPERATURE CURVE

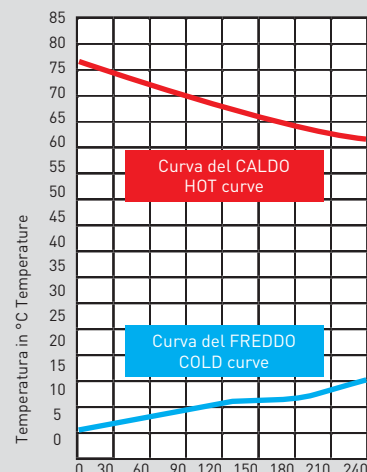

N

Contenitore isotermico POWERBOX
Insulated container
Thermobehälter
Conteneur isotherme
Contenedor isotérmico

art.	cm. ext.	cm. int.	lt.
44961-05	64,5x40x31,5	55x34x24	45



Contenitore isotermico UNIVERSAL PN
Insulated container
Thermobehälter
Conteneur isotherme
Contenedor isotérmico

art.	cm. ext.	cm. int.
44986-12	61x43x20	54,5x36,5x12
44986-17	61x43x25	54,5x36,5x17
44986-21	61x43x29,5	54,5x36,5x21,5
44986-28	61x43x36,5	54,5x36,5x28,5



Contenitore isotermico per pasticceria
Insulated pastry box
Konditorei-Thermobehälter
Conteneur isotherme à pâtisserie
Contenedor isotérmico

art.	cm. ext.	cm. int.
44974-21	68,5x48,5x27	62,5x42,2x21
44974-27	68,5x48,5x33	62,5x42,2x27
44974-31	68,5x48,5x37	62,5x42,2x31



N

Contenitore isotermico BOXSHOP
Insulated container
Thermobehälter
Conteneur isotherme
Contenedor isotérmico

art.	cm. ext.	cm. int.	lt.
44961-02	41,5x32x32	35x27x25	21,6



N

Contenitore isotermico TROLLEYBOX
Insulated container
Thermobehälter
Conteneur isotherme
Contenedor isotérmico

art.	cm. ext.	cm. int.	lt.
44961-04	42x42x60	36x36x46	60



N

Contenitore isotermico PIZZABOX
Insulated container
Thermobehälter
Conteneur isotherme
Contenedor isotérmico

art.	cm. ext.	cm. int.	lt.
44961-03	42x42x34,5	36x36x28	36

Con sistema di rilascio del vapore.
With steam release system.



+ OPTIONAL
44979-05
44979-02
44987C11

**COLD
HOT
DOLLY**



Contenitore isotermico PORTER GN 1/1
Insulated box GN 1/1
GN 1/1 Thermobehälter
Conteneur isotherme GN 1/1
Contenedor isotérmico GN 1/1

art.	cm. ext.	cm. int.
44987-11	65x50x61	54x33x48

Per GN 1/1 o sottomultipli. 12 guide.
For GN 1/1 or submultiples. 12 guides.

+ OPTIONAL
44979-06
44987C60

**COLD
DOLLY**



Contenitore isotermico PORTER MAXI
Insulated box
Thermobehälter
Conteneur isotherme
Contenedor isotérmico

art.	cm. ext.	cm. int.
44987-60	72x60x63	60x40x50

9 guide. - 9 guides.



+ OPTIONAL
44967C62 **DOLLY**

Contenitore isotermico GN CRYSTAL®
Insulated container
Thermobehälter
Conteneur isotherme
Contenedor isotérmico

art.	cm. ext.	cm. int.
44968-00	60x40x30	54x34x24

Robusto e leggero con interno cristallizzato perfettamente liscio, rigido e impermeabile. - Strong and light, inside crystallized and therefore perfectly smooth, rigid and waterproof.



Accumulatore di freddo
Eutectic pad
Kühlakku
Cartouche eutectique
Placa eutética

art.	dim. cm.	°C	GN
44979-04	32,5x26,5x3	0/-21	1/2
44979-05	53x32,5x3	0/-21	1/1
44979-06	60x40x3	0/-21	



Accumulatore di caldo
Heat accumulator
Wärmespeicher
Accumulateur de chaleur
Acumulador de calor

art.	dim. cm.	°C	GN
44979-02	53x32,5x3	0/+85	1/1



Carrello, alluminio/ABS
Dolly, aluminum/ABS
Fahrgestell, Aluminium/ABS
Chariot, aluminium/ABS
Carro, aluminio/ABS

art.	dim. cm.	per/for
44975C50	58,5x58,5	44975-50
44987C11	68x52	44987-11
44987C60	75x61	44987-60
44967C62	62x42	44968-00



Box isotermico Domus
Insulated Domus box
Domus-Thermobehälter
Conteneur isotherme Domus
Contenedor individual isotérmico

art.	dim. cm.	dim. int.
44976-04	44x38x12	40x34x90

3 vani indipendenti per piatti di ø 12 cm., h 6 cm., o da 16x16 cm. - 3 separate sections for dishes ø 12 cm., h 6 cm. or size 16x16 cm.



Box isotermico Dinner Box
Insulated Dinner box
Dinner Box-Thermobehälter
Conteneur isotherme Dinner box
Contenedor individual isotérmico

art.	dim. cm.	h.
44976-05	24x25	35

3 vani coibentati. Apertura frontale.
3 compartments. Front opening.

STOCCAGGIO E TRASPORTO STORAGE & TRANSPORT



BASE E COPERCHIO
BASE AND LID
44975-35



ESTENSORE
EXTENDER
44975H35



BASE E COPERCHIO
BASE AND LID
44975-35

Contenitore isotermico **PIZZA**
Insulated container
Thermobehälter
Conteneur isotherme
Contenedor isotérmico

art.	cm. ext.	cm. int.	
44975-35	41x41x7,5	35x35x7,5	Base e coperchio/Base and lid
44975H35	41x41x7,5	35x35x4,5	Estensore/Extender



BASE E COPERCHIO
BASE AND LID
44975-50



ESTENSORE
EXTENDER
44975H50



BASE E COPERCHIO
BASE AND LID
44975-50

Contenitore isotermico **PIZZA**
Insulated container
Thermobehälter
Conteneur isotherme
Contenedor isotérmico

art.	cm. ext.	cm. int.	
44975-50	57x57x10,5	51x51x10,5	Base e coperchio/Base and lid
44975H50	57x57x10,5	51x51x6,3	Estensore/Extender



Box isotermico 2 vani
Insulated box, 2 compartments
2-Abteilung-Thermobehälter
Conteneur isotherme, 2 compartments
Contenedor individual isotérmico

art.	dim. cm.	dim. int.
44976-02	42,5x26,5x16,5	38x22x12

Due vani indipendenti, per piattini in PP 18x18 cm. - Two separate sections for polypropylene dishes size 18x18 cm.



Box isotermico Monoking
Insulated Monoking box
Monoking-Thermobehälter
Conteneur isotherme Monoking
Contenedor individual isotérmico

art.	dim. cm.	dim. int.
44976-01	42,5x35x16	42x29x12

Due vani coibentati per piattini in PP 18x18 cm. - With two insulated sections for polypropylene dishes size 18x18 cm.



Box isotermico Thermoking
Insulated Thermoking box
Thermoking-Thermobehälter
Conteneur isotherme Thermoking
Contenedor individual isotérmico

art.	dim. cm.	dim. int.
44976-03	47x37x18,5	40x30x11,5

Coperchio a incastro. Altezza utile interna 11,5 cm. - With release latch lid. Usable internal height 11,5 cm.

Il sistema modulare dove base e coperchio sono lo stesso elemento e grazie all'inserto estensore è possibile aumentare la capacità - The modular system where the base and lid are the same element and due to the extender insert it is possible to increase capacity.

PIZZA FAMILY 50 X 50 CM

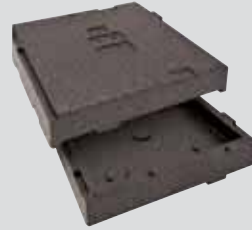

PIZZA SINGLE 35 X 35 CM

DOLCISSIMA 35 X 35 CM - 50 X 50 CM

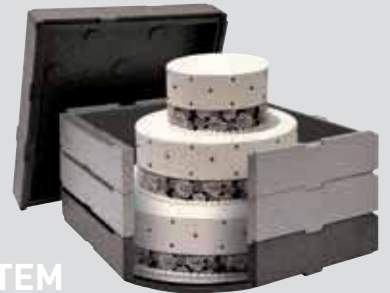

FINGER FOOD SYSTEM 50 X 50 CM



44975C50

DOLLY

NO LIMITS

Aumenta la capacità - sovrapposizione base/coperchio - con estensione.
Increases capacity - overlapping base/lid - with extender insert.



Contenitore isotermico, inox AISI 304
Insulated container, stainless steel
Thermobehälter, Edelstahl Rostfrei
Conteneur isotherme, inox
Contenedor isotérmico, inox

art.	ø cm.	h.	lt.	kg.
44505-05	30	17,0	5	3
44505-10	30	22,5	10	4
44505-15	36	21,5	15	5
44505-20	36	28,5	20	6
44505-25	36	35,0	25	7



1. Impilabile.
2. Impugnature ergonomiche.
3. Coperchio a chiusura ermetica.
4. Valvola di sfiato per evitare l'effetto sottovuoto.
5. Guarnizioni in gomma vulcanizzata.
6. Realizzazione a doppia parete.
7. Rubinetto h. 11 cm.

1. Stackable.
2. Ergonomic handles.
3. Tight-fitting lid.
4. Vent valve to prevent vacuum effect.
5. Vulcanized rubber gaskets.
6. Double-wall construction.
7. Tap height 11 cm.



Contenitore isotermico GN 1/1
Insulated container GN 1/1
Thermobehälter GN 1/1
Conteneur isotherme GN 1/1
Contenedor isotérmico GN 1/1

art.	ø cm.	h.	lt.	kg.
44506-05	30	28	5	5
44506-09	30	34	9	6

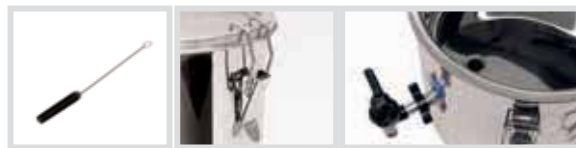

Incluso spazzolino per la pulizia, serie di etichette Latte, Caffè e Tè in 5 lingue. - Included into the package cleaning brush and labels set Milk, Coffee and Tea in 5 languages.



Pietanziera, inox
Food container, stainless steel
Speisenbehälter, 18-10 Edelstahl
Porte-manger, inox
Contenedor comida, inox

art.	ø cm.	h.
44977-12	12	6



Contenitore isotermico GN 1/1
Insulated container GN 1/1
Thermobehälter GN 1/1
Conteneur isotherme GN 1/1
Contenedor isotérmico GN 1/1

art.	dim. cm.	lt.	kg
44932-15	61x41x25	24,6	5,9
44932-20	61x41x30	31,1	5,9



Contenitore isotermico GN 1/1
Insulated container GN 1/1
Thermobehälter GN 1/1
Conteneur isotherme GN 1/1
Contenedor isotérmico GN 1/1

art.	dim. cm.	lt.	kg
44934-30	44x64x48	63	11,5



Distributore di bevande isotermico
Insulated beverage dispenser
Isolierte Getränkebehälter
Conteneur isotherme avec robinet
Contenedor isotérmico con grifo

art.	dim. cm.	lt.	kg
44930-10	24x43x43	10	4,6
44930-20	30x46x46	20	6,0

Per 3 GN 1/1 h. 20 cm. 50-70 pasti.
For 3 pans GN 1/1 h. 20 cm. 50-70 meals.



Carrello termico GN 3/1
Thermic wagon GN 3/1
Wärmewagen GN 3/1
Chariot thermique GN 3/1
Carro térmico GN 3/1

art.	dim. cm.	V	KW
44802-31	116x67x86	230	2

In acciaio inox, con riscaldamento a bagno maria. Vasca coibentata, dotata di rubinetto di scarico. Termostato meccanico 0-90°C, spia di accensione, termostato di sicurezza. 4 ruote pivotanti di cui 2 con freno. Forniti senza vasche GN, da ordinarsi separatamente. - Stainless steel construction. Insulated tank with drain cock. Mechanical thermostat 0-90°C, pilot light, safety thermostat. 4 swivel casters, 2 with brakes. Supplied without GN pans, to be ordered separately.

Per 2 GN 1/1 h. 20 cm. 35-50 pasti.
For 2 pans GN 1/1 h. 20 cm. 35-50 meals.



Carrello termico GN 2/1
Thermic wagon GN 2/1
Wärmewagen GN 2/1
Chariot thermique GN 2/1
Carro térmico GN 2/1

art.	dim. cm.	V	KW
44802-21	84x67x86	230	2



Contenitore isotermico, PE
Insulsierte-Carrier, PE
Isolierte-Thermobehälter, PE
Conteneur isotherme, PE
Contenedor isotérmico, PE



art.	dim. cm.	h.	lt.
44935-01	47,6x67,9	70,5	89
44935-02	47,6x67,9	85,4	89

Per 6 GN 1/1 o sottomultipli, h. 65 mm.
For 6 GN 1/1 or submultiples, h. 65 mm.



Carrello porta ghiaccio
Ice cart
Eiswagen
Chariot à glace
Carro hielo

art.	dim. cm.	carico-load
44936-57	72x57x85	kg. 57

Coperchio brevettato a 3 posizioni, senza cerniere metalliche. La doppia parete e l'alto grado d'isolamento mantengono il ghiaccio per lunghi periodi. Costruzione in polipropilene grigio stampato, polimeri resistenti a ruggine e corrosione. Ruote antiriscaldamento. Due ruote anteriori girevoli (Ø 127 mm) di cui una con freno. Due ruote posteriori fisse (Ø 203 mm).
Unique, patented 3-position lid offers multiple openings without lid removal or use of metal hinges. Double wall and deep insulation will hold ice for extended periods. Durable molded gray polyethylene construction, rust and corrosion proof polymer construction. Non-marking casters. Two front swivel casters (127mm) one with brake. Two (203mm) fixed rear wheels.



Pala ghiaccio con supporto, PC
Ice scoop with holder
Eisschaufel mit Träger
Pelle à glace avec support
Librador hielo con soporte

art.	dim. cm.	h.	lt.
44936-02	30,7x20,3	19	2

Paletta dotata di paramani e supporto. Dotata di bordo d'attacco rinforzato. Lavabile in lavastoviglie.
Ice scoop with hand guard and holder. Equipped with reinforced attachment board. Washable in dishwasher.



Secchio ghiaccio, PC
Ice bucket
Eiseimer
Seau à glace
Cubo hielo

art.	dim. cm.	h.	lt.
44936-20	33,7x31	45,3	20,8

Secchiello per ghiaccio con adattatore. L'adattatore si aggancia alle macchine per il ghiaccio. Sistema di presa inferiore sollevato dal suolo per prevenire la contaminazione incrociata. Non impilabile; lavabile in lavastoviglie.
Ice bucket with adapter. The bucket hook adapter attaches to ice machines. Lower grip system raised from the ground to prevent cross contamination. Not stackable, washable in dishwasher.

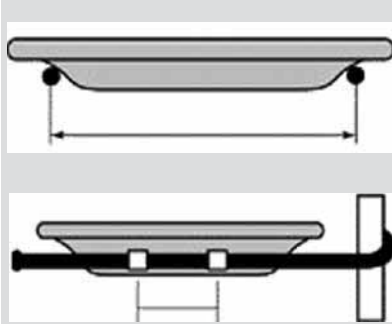

JACKSTACK. Struttura in acciaio saldato. Rivestimento nero elettrostatico. Assemblaggio veloce. Adattabile ad ogni misura di piatto (ø max cm 30, kg 3 cad.). Lunghezza bracci 17 cm, distanza 5 cm.
Welded steel construction. Black electrostatic powder coating. Quick set assembly in minutes. Quick-change to any plate size (max ø cm 30, kg 3 each). Length of plate support 17 cm, spacing 5 cm.

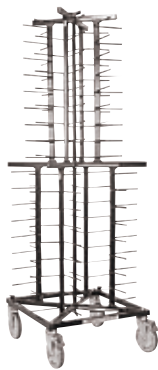

Carrello porta piatti, 104 pz.
 Mobile plate rack, 104 pcs
 Fahrbares Tellergerüst, 104 Stk.
 Chariot porte-assiettes mobile, 104 pcs
 Carrito para almacenaje de platos, 104 pz

Carrello porta piatti
 Mobile plate rack
 Fahrbares Tellergerüst
 Chariot porte-assiettes mobile
 Carrito para almacenaje de platos

Porta piatti rotante
 Swivelling table top rack
 Drehbares Tischgerüst
 Porte-assiettes de table pivotant
 Soporte para almacenaje de platos

art.	dim. cm.	h.	kg.
44830-99	60x60	179	30

art.	dim. cm.	h.	kg.
44830-72	60x60	179	28

art.	dim. cm.	h.	kg.
44831-52	48x48	89	13



Copertura in plastica
 Zippered plastic cover
 Plastik Schutzhülle
 Housse en plastique
 Cubrecarrito, plástico

Copertura termica
 Thermo cover
 Thermo-Hülle
 Thermo-housse
 Cubrecarrito, térmico

Carrello porta piatti
 Mobile plate rack
 Fahrbares Tellergerüst
 Chariot porte-assiettes mobile
 Carrito para almacenaje de platos

art.	per/for item #
44832-99	44830-72 & 44830-99

art.	per/for item #
44833-52	44830-52 & 44831-52
44833-99	44830-72 & 44830-99

art.	dim. cm.	h.	kg.
44830-52	60x60	103	22

STOCCAGGIO E TRASPORTO STORAGE & TRANSPORT

In caso di acquisto del solo box termico specificare con quale tavolo deve essere utilizzato. - If the hot box is ordered individually always indicate under which table it will be used.



Box termico, inox
Thermic box, stainless steel
Speisen-Kaste, Edelstahl Rostfrei
Caisson thermique, inox
Cajón térmico, inox

art.	dim. cm.	h.	Volt/Watt
44094-00	38x45	52	230/500

Termostato meccanico 0-90°C, spia di accensione, termostato di sicurezza, cavo asportabile da 2 mt. - Mechanical thermostat 0-90°C, pilot light, safety thermostat, removable cable length 2 mt.



Carrello room-service, top fisso
Room-service trolley, fix top
Room-Service-Wagen, fix Tischplatte
Chariot room-service, étagère fix
Carro room-service, top fijo

art.	dim. cm.	h.
44094-01	ø90/55	77

Struttura tubolare cromata, piano laminato grigio grafite con texture antiscivolo e antigraffio, 2 ruote con freno. - Chromed tube structure, laminated top in graphite gray with non-slip and scratch-resistant texture, 2 castors with brakes.



Carrello con box termico
Trolley with thermic box
Wagen mit Speisen-Kaste
Chariot avec caisson thermique
Carro con cajón térmico

art.	dim. cm.	h.	Volt/Watt
44094-02	ø90/55	77	230/500

[44094-00 + 44094-01]



Carrello room-service, top ribaltabile
Room-service trolley, revolving top
Room-Service-Wagen, Klappbaretischplatte
Chariot room-service, étagère rabattable
Carro room-service, top abatible

art.	dim. cm.	h.
44094-03	ø90/55	77
Chiuso-Closed	55x74	117



Carrello con box termico
Trolley with thermic box
Wagen mit Speisen-Kaste
Chariot avec caisson thermique
Carro con cajón térmico

art.	ø cm.	h.	Volt/Watt
44094-04	90	79	230/500

[44094-00 + 44094-03]



Carrello room-service, top pieghevole
Room-service trolley, folding top
Room-Service-Wagen, Kippbaretischplatte
Chariot room-service, étagère pliable
Carro room-service, top puegable

art.	dim. cm.	h.
44094-05	ø90	76
Chiuso-Closed	90x33	98



Carrello con box termico
Trolley with thermic box
Wagen mit Speisen-Kaste
Chariot avec caisson thermique
Carro con cajón térmico

art.	dim. cm.	h.	Volt/Watt
44094-06	ø90/73	76	230/500

[44094-00 + 44094-05]



Coperture monouso, 200 pezzi
Disposable covers, 200 pcs
Einweg-Schutzhüllen, 200 Stk.
Housses usage unique, 200 pcs
Cubrecarritos desechables, 200 pz

art.	per/for	h.
42512-91	GN 1/1	180
42512-92	GN 2/1 60x40	180



Porta rotolo, inox
Roll holder, stainless steel
Rollenhalter, Edelstahl Rostfrei
Dérouleur mural, inox
Portarollos, inox

art.	dim. cm.	h.	kg.
42512-90	90x23	19	1,5



Carrello GN 2/1, inox
Utility rack GN 2/1, stainless steel
2/1 GN-Behälterwagen, E. R.
Chariot GN 2/1, inox
Carro GN 2/1, inox

art.	dim. cm.	h.
44807-28	60x70	153,5

Struttura saldata, 28 guide, 4 ruote girevoli di cui 2 con freno.
Welded structure, 28 rails, 4 wheels, 2 with brakes.



18 GN 2/1
36 GN 1/1

Carrello GN 2/1, inox
Utility rack GN 2/1, stainless steel
2/1 GN-Behälterwagen, E. R.
Chariot GN 2/1, inox
Carro GN 2/1, inox

art.	dim. cm.	h.
44807-36	73x62	6,88 171

Fornito smontato, 18 guide, accoglie GN di h. 65 mm. Carico max 300 kg. - To be assembled, 18 rails, accomodates GN pans height 65 mm. Load max 300 kg.



9 GN 2/1
18 GN 1/1

Carrello GN 1/1, inox
Utility rack GN 1/1, stainless steel
1/1 GN-Behälterwagen, E. R.
Chariot GN 1/1, inox
Carro GN 1/1, inox

art.	dim. cm.	h.
44807-18	38x62	6,9 164

Fornito smontato, 18 guide, accoglie GN di h. 65 mm. Carico max 150 kg. - To be assembled, 18 rails, accomodates GN pans height 65 mm. Load max 150 kg.



Carrello GN 1/1, inox
Utility rack GN 1/1, stainless steel
1/1 GN-Behälterwagen, E. R.
Chariot GN 1/1, inox
Carro GN 1/1, inox

art.	dim. cm.	h.
44801-09	38x62	6,9 94,5

Fornito smontato, 9 guide, accoglie GN di h. 65 mm. Carico max 75 kg. - To be assembled, 9 rails, accomodates GN pans height 65 mm. Load max 75 kg.



Carrello GN 2/1, inox
Utility rack GN 2/1, stainless steel
2/1 GN-Behälterwagen, E. R.
Chariot GN 2/1, inox
Carro GN 2/1, inox

art.	dim. cm.	h.
44801-18	73x62	6,88 94,5

Fornito smontato, 9 guide, accoglie GN di h. 65 mm. Carico max 150 kg. - To be assembled, 9 rails, accomodates GN pans height 65 mm. Load max 150 kg.



Carrello porta teglie, inox
Baking sheet trolley, stainless steel
Backbleche-Wagen, Edelstahl Rostfrei
Chariot pour plaques, inox
Carro porta placas, inox

art.	dim. cm.	h.
44826-08	53x67	89

Struttura avvitata, 8 guide per teglie 60x40 cm, distanza guide 7,5 cm, 2 ruote con freno. - Screwed structure, 8 rails for baking sheets 60x40, height clearance 7,5 cm, 2 wheels with brakes.



Carrello porta teglie, inox
Baking sheet trolley, stainless steel
Backbleche-Wagen, Edelstahl Rostfrei
Chariot pour plaques, inox
Carro porta placas, inox

art.	dim. cm.	h.	carico/load
44826-20	69x49	7,8 187	kg.100

20 guide per teglie cm 60x40, distanza guide 8 cm. - 20 rails for baking sheets cm 60x40, height clearance 8 cm.



Carrello porta teglie, zincato
Baking sheet trolley, galvanized steel
Backbleche-Wagen, verzinkt
Chariot pour plaques, galvanisé
Carro porta placas, galvanizado

art.	dim. cm.	h.	carico/load
44825-20	51x50	6,6 170	kg.80

20 guide, distanza guide 8 cm.
20 rails, height clearance 8 cm.



Carrello porta teglie, zincato
Baking sheet trolley, galvanized steel
Backbleche-Wagen, verzinkt
Chariot pour plaques, galvanisé
Carro porta placas, galvanizado

art.	dim. cm.	h.	carico/load
44825-40	51x75	6,6 170	kg.160

40 guide, distanza guide 8 cm.
40 rails, height clearance 8 cm.



5 piani, 3 regolabili.
Struttura in metallo verniciata grigia, pannelli laterali in legno HPL. 2 ruote con freno. Portata max 250 kg equamente distribuiti. - 5 shelves, 3 of them adjustable.
Metal structure, grey enamelled, HPL wood side walls. 2 wheels with brake. Max load kg 250 evenly distributed.

Carrello servizio
Service trolley
Servierwagen
Chariot de service
Carro de servicio

art.	dim. cm.	h.
44095-06	85x57	131
44095-07	105x57	131



Carrello di servizio, inox
Serving trolley, stainless steel
Mehrzweckwagen, Edelstahl Rostfrei
Chariot de service, inox
Carrito para desocupar, inox

art.	dim. cm.	h.
44820-80	80x50	93,5
44820-99	100x50	93,5

Fornito smontato, 4 ruote girevoli di cui 2 con freno. Portata max. per ripiano kg 30.
To be assembled, 4 swivel castors, 2 with brakes. Max load per shelf kg 30.



Carrello di servizio, inox
Serving trolley, stainless steel
Mehrzweckwagen, Edelstahl Rostfrei
Chariot de service, inox
Carrito para desocupar, inox

art.	dim. cm.	h.	carico/load
44819-02	91x59	93	kg. 80

Fornito smontato, 4 ruote girevoli di cui 2 con freno. - **To be assembled, 4 swivel castors, 2 with brakes.**



Carrello servizio, inox
Service trolley, stainless steel
Servierwagen, Edelstahl Rostfrei
Chariot de service, inox
Carro de servicio, inox

art.	dim. cm.	h.
44095-05	83x53	135

Fornito smontato. Con sacco in PVC, 2 ruote con freno. - **To be assembled. Equipped with PVC bag and 2 wheels with brake.**



Carrello di servizio, inox
Serving trolley, stainless steel
Mehrzweckwagen, Edelstahl Rostfrei
Chariot de service, inox
Carrito para desocupar, inox

art.	dim. cm.	h.
44822-80	80x50	93,5
44822-99	100x50	93,5

Fornito smontato, 4 ruote girevoli di cui 2 con freno. Portata max. per ripiano kg 30.
To be assembled, 4 swivel castors, 2 with brakes. Max load per shelf kg 30.



Carrello di servizio, inox
Serving trolley, stainless steel
Mehrzweckwagen, Edelstahl Rostfrei
Chariot de service, inox
Carrito para desocupar, inox

art.	dim. cm.	h.	carico/load
44819-03	91x59	93	kg. 120

Fornito smontato, 4 ruote girevoli di cui 2 con freno. - **To be assembled, 4 swivel castors, 2 with brakes.**



Carrello 3 ripiani, PP
3-shelf cart, PP
Mehrzweckwagen mit 3 Etagen, PP
Chariot de service, 3 plateaux, PP
Carrito para desocupar, 3 niveles, PP

art.	dim. cm.	h.	kg.
44030-03	42x71	90	11,5



Cesti e contenitori, PP
Bins and containers, PP
Kasten und Körbe, PP
Réipients et containers, PP
Cubos y contenedores, PP

art.	dim. cm.	h.	kg.
44033B23	66x45	23,0	2,10
44031-04	52x39	12,7	0,75
44031-05	52x39	17,7	0,92



Contenitore, PE-HD
Container, PE-HD
Kaste, PE-HD
Réipient, PE-HD
Contenedor, PE-HD

art.	dim. cm.	h.	kg.
44031-01	33,7x23	56,0	2,10
44031-02	33,7x23	18,7	0,85



Carrello di servizio, PP
Serving trolley, PP
Mehrzweckwagen, PP
Chariot de service, PP
Carrito para desocupar, PP



art. dim. cm. h.
49995-04 97x51 99

Portata 135 kg (45 kg per ripiano). - High load capacity 135 kg (45 kg per shelf).



Carrello per rifornimento frigobar
Minibar restocking cart
Wagen für Minibar-Versorgung
Chariot mini-bar
Carro servicio minibar

art. dim. cm. h. carico/load
44095-03 105x54 119 kg.250

Metallo verniciato grigio, 3 cassetti estraibili, chiusura con serratura, 4 ruote pivotanti ø200mm di cui 2 con freno. - Structure in grey enamelled metal, 3 drawers, doors with lock, 4 swivel casters ø200mm, 2 with brakes.



Carrello per rifornimento frigobar
Minibar restocking cart
Wagen für Minibar-Versorgung
Chariot mini-bar
Carro servicio minibar

art. dim. cm. h. carico/load
44095-04 85x54 132 kg.250

Legno laminato in 17 colori, 3 cassetti estraibili, chiusura con serratura, 4 ruote pivotanti di cui 2 con freno. - Laminated wood structure available in 17 colors, 3 drawers, doors with lock, 4 swivel casters, 2 with brakes.



Carrello per rifornimento frigobar
Minibar restocking cart
Wagen für Minibar-Versorgung
Chariot mini-bar
Carro servicio minibar

art. dim. cm. h. carico/load
44095-01 82x53 112 kg.150

Struttura tubolare cromata, ripiani laminato noce, 4 ruote pivotanti.
Tube chromed structure, laminated shelves walnut color, 4 swivel castors.



Carrello porta cassette, inox
Dolly for cases, stainless steel
Plattformwagen, Edelstahl Rostfrei
Chariot à caisses, inox
Carretilla de transporte, inox

art. dim. cm. h. carico/load
44026-60 65x45 12 kg. 50



Carrello trasporto materiali, PE
Platform cart, PE
Plattformwagen, PE
Chariot de transport, PE
Plataforma móvil, PE

art. dim. cm. h. carico/load
49378-00 82,6x52 98,7 kg. 181

Maniglia regolabile in 3 posizioni. Superficie antiscivolo. 2 ruote fisse e 2 pivotanti. - Three position handle ensures optimum handling whatever the load. Non slip deck, 2 swivel and 2 rigid castors.



Carrello convertibile, PP
Trolley, PP
Plattformwagen, PP
Chariot, PP
Carretilla, PP

art. dim. cm. h.
49379-00 56x53 43,5



Ruote antitraccia di cui 2 fisse e 2 girevoli, ruote posteriori bloccabili. Struttura in PP e metallo verniciato.
Four non-marking casters (two rear locking), 2 swivel and 2 rigid. Structure PP and powder coated metal.

Realizzabili in 17 colori di legno laminato e completati con vari optional per qualsiasi necessità di utilizzo. Buffet disponibili anche in dimensione 4 e 5 GN 1/1.

Can be manufactured in 17 different laminated wood colors and can be equipped with various optional to satisfy any needs. Buffet available also in 4 and 5 GN 1/1 sizes.



Buffet refrigerato, 3x GN 1/1
Refrigerated buffet
Kühl-Bufferwagen
Buffet réfrigéré
Buffet refrigerado



art.	dim. cm.	h.
49994-06	74,3x117	151

Refrigerati con struttura in legno laminato. Calottina superiore in Plexiglass fissa. Vasca profonda 26 cm. con rubinetto di scarico. Refrigerazione statica gas R404a. Termostato digitale (+2°/+8°C). Illuminazione a LED. Due ruote in poliammide con freno di serie.
Refrigerated buffets with laminated wood structure. Upper Plexiglas fixed sneezeguard. Well 26 cm. deep with drain cock. Static refrigeration of the well, gas R404a. Digital thermostat (+2°/+8°C) and lighting with LED. Two polyamide castors with brake included.

Completo di portapiatti perimetrale, chiusura vano inferiore con pareti e porte con sistema di chiusura rallentata.

OPTIONAL da ordinarsi separatamente: griglie inox 3x GN 1/1, vasche GastroNorm.

Supplied with perimeter dish shelf, lower compartment closure with walls and doors with slow closing system.

OPTIONALS to be ordered separately: stainless steel grid 3x GN 1/1, GastroNorm pans.



Buffet bagnomaria con alogene, 3x GN 1/1
Heated buffet with halogen lamps
Beheizte Buffetwagen mit Halogenlampen
Buffet chauffé avec lampes halogènes
Buffet caliente con lámparas halógenas



art.	dim. cm.	h.
49994-10	74,3x117	151

Riscaldato con struttura in legno laminato. Calottina superiore in Plexiglas fissa. Vasca profonda 26 cm. con rubinetto di scarico. Riscaldamento a bagnomaria con termostato digitale. Due ruote in poliammide con freno di serie. Lampade alogene ad accensione indipendente.

Heated buffet, laminated wood structure. Upper fixed sneezeguard. Well depth 26 cm. with drain cock. Bain marie heating and digital thermostat. Two castors with brake included. Equipped with halogen lamps over the well with independent switch.

Completo di portapiatti perimetrale, chiusura vano inferiore con pareti e porte con sistema di chiusura rallentata.

OPTIONAL da ordinarsi separatamente: griglie inox 3x GN 1/1, vasche GastroNorm.

Supplied with perimeter dish shelf, lower compartment closure with walls and doors with slow closing system.

OPTIONALS to be ordered separately: stainless steel grid 3x GN 1/1, GastroNorm pans.



PULIZIA E SICUREZZA *CLEANING & SAFETY*



Quick Cart

art.	dim. cm.	h.	kg.	int. dim. cm.	cap. kg.	cap. m ³	model
44178-01	41,9x36,3	43,2	6,53	40,6x31,7x36,8	13,6	0,048	SMALL
44178-02	41,9x36,3	53,3	7,17	40,6x31,7x47	18,1	0,060	MEDIUM
44178-03	41,9x36,3	63,5	7,80	40,6x31,7x57,1	27,2	0,074	LARGE

Design elegante. Aspetto discreto: design compatto, poco appariscente agli sguardi nelle aree pubbliche fino a scomparire nelle camere. Design compatto ed ergonomico: leggeri e più compatti rispetto ai carrelli tradizionali, facili da manovrare in spazi ristretti. Scomparti versatili consentono molteplici configurazioni e usi. - **Smart design. Discreet, appearance: compact design remains inconspicuous by blending into public areas and disappearing into guest rooms. Compact and ergonomic design: lightweight and more compact than traditional carts for easier manoeuvrability in tight spaces. Versatile compartments allow for multiple configurations and uses.**

**Divisori removibili
Adjustable dividers**

**Cestello estraibile
Removable caddy**

**Respinge acqua, olio e macchie
Rivestimento in Teflon®
Repels water, oil and stains
Teflon® fabric protector**

**Scocca rinforzata
in gomma
Reinforced rubberised
kick plate**

SALVASPAZIO - SPACE SAVING!

Telaio pieghevole, acciaio verniciato
Collapsible frame, powder coated steel
Klappbares Gestell, pulverbeschichtete Stahl
Châssis repliable, acier peint
Carre plegable, acero pintado

Sacco vinile, nero
Vinyl bag, black
Vinyl-Sack, schwarz
Sac en vinyle, noir
Bolsa de vinilo, negro

Copertura vinile, nero
Vinyl bag cover, black
Vinyl-Sack-deckel, schwarz
Couvercle à sac en vinyle, noir
Tapa para bolsa de vinilo, negro

art.	dim. cm.	h.	lt.
44178-15	51,6x61,3	83,9	150
44178-16	88,9x61,3	83,9	300

art.	dim. cm.	h.	lt.
44178-17	39x56,9	69,3	150
44178-18	78x56,9	69,3	300

art.	dim. cm.	h.
44178-19	64,4x50,4	22,8
44178-20	88,9x66,6	22,8

chiuso/closed

44178-15	39x56,9	69,3	150
44178-16	78x56,9	69,3	300

Telaio pieghevole consente uno stoccaggio efficiente. Design compatto e leggero per una maggiore manovrabilità. Sacchi in vinile durevoli, ad alta capacità (100 kg); facili da pulire. Copertura: con tasche integrate su ogni lato. Comodo, accesso rapido all'interno del carrello, senza dover rimuovere il coperchio. Telaio rimane pieghevole con o senza copertura. - **Collapsible frame enables efficient storage. Compact, lightweight design for superior manoeuvrability. Durable, high capacity (100 kg) vinyl bag accommodates large loads; easy-to-clean. X-Cart Cover: multiple, built-in storage pockets on each side. Convenient, Quick-Access-Lid provides easy access to contents inside of cart without having to remove cover. Frame remains collapsible with or without cover.**



Sistema di pulizia, kit Pulse
Cleaning system, Pulse
Reinigungssystem Pulse
Système de nettoyage Pulse
Sistema de limpieza Pulse



art.	dim. cm.	h.
44151-00	12,4x9,5	142,2

Telaio in alluminio con velcro da 40 cm, 2 mop in microfibra. Dotato di deposito integrato da 700 ml che permette di pulire fino a 80 mq.
Aluminum frame 40 cm and 2 microfibre mops. On-board reservoir 700 ml that allows to clean up to 80 sqm.

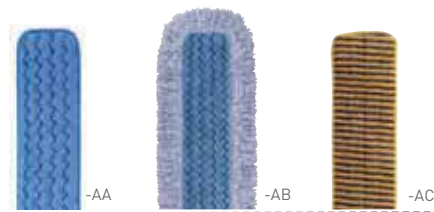

Mop in microfibra, conf. 10 pz
Microfibre mop, 10 pcs pack
Microfibre-Mop, 10 Stück Packung
Frange en microfibra, 10 pcs
Fregadora de microfibra, 10 piezas

art.	dim. cm.	h.	
44151-AA	40x14	1,6	Wet mop
44151-AB	40x14	1,6	High absorbency WM
44151-AC	40x14	1,6	Scrubber mop

Uso umido ad elevata assorbenza, per 80 mq. Ciclo di vita: 500 lavaggi (200 con candeggina) ad elevate temperature.
Wet use, high absorbency, for 80 sqm. Launderable up to 500 times (200 with bleach) at high water temperature.



Aspirapolvere meccanico
Mechanical sweeper
Kehrer mit mechanischem Antrieb
Balai mécanique
Escoba mecánica

art.	dim. cm.	h.	lt.
44150-19	28,6x24,8	101,6	0,6

Battuta/Sweeping path: 19 cm. In ABS e acciaio galvanizzato. Ideale sia per tappeti/moquette a pelo corto che per pavimenti. - ABS and galvanised steel construction. Ideal for hard floors and low pile carpets.



Scopa + alza immondizia, PP
Broom + dust pan, PP
Kehrset mit Stiel und Schmutzcontainer, PP
Balai + pelle, PP
Escoba + recogedor, PP

art.	dim. cm.	h.
44149-03	28,6x12,7	32,4

Porta immondizia con coperchio. Staffa di supporto per scopa.
Self opening and closing lid. Broom hanger bracket.



Paletta con serbatoio, PP
Wet/dry spill pan, PP
Schmutzcontainer, PP
Pelle avec réservoir, PP
Recogedor, PP

art.	dim. cm.	h.	lt.
44148-00	43x31,5	103	2

Permette di raccogliere qualunque tipo di rifiuto solido o liquido.
Allows to collect any type of solid or liquid waste.



Scopa spingiacqua
Cleaning wand
Abzieher
Balai raclette
Escoba

art.	dim. cm.
44148-01	116,8x40

Testa della scopa realizzata in morbida gommaspugna a doppio strato sostenuta da telaio in metallo galvanizzato. - Blade made of soft double mass squeegee foam supported by a galvanized metal frame.



Manico per mop
Wet mop handles
Nassmopp-Stiele
Supports pour franges
Mangos para fregonas

art.	l. cm.	colore/color
44141-01	152,4	●
44141-03	152,4	●

Polipropilene/fibra di vetro. - Polypropylene/Glass fiber.

Mop a strisce in cotone
Cotton-end string mop
Spaghetti-Mop mit Baumwollend
Frangé à ficelles en coton
Mopa de algodón

art.	gr.
44142-40	400

Alta capacità di assorbimento. La lavorazione delle frange riduce la formazione di grovigli. - High absorbency. Looped-ends and tail banding reduces tangling.



Panno in microfibra, conf. 12 pz
Microfibre cloth, 12 pcs pack
Mikrofasertuch, 12 Stück Packung
Carré en microfibre, 12 pcs
Paño de microfibra, 12 piezas

art.	dim. cm.	colore/color
44147-00	40,6x40,6	●
44147-01	40,6x40,6	●
44147-02	40,6x40,6	●
44147-03	40,6x40,6	●

Dura 100 lavaggi con candeggina e 250 senza.
Launderable up to 100 times with bleach and 250 without bleach.



Cavalletto di segnalazione a 2 lati, PP
2-sided floor sign, PP
2-seitig, Warnschild
Panneau d'avertissement 2 côtés, PP
Señal de suelo 2 lados,

art.	dim. cm.	colore/color
44077-CC	67,3x27,9x30,5	●
44077-CE	67,3x27,9x30,5	●



VASSOI IN MELAMINA
Melamine trays
PAGINA - Page: 372-373

Distributore di sapone in schiuma, cromo/nero
AutoFoam™ Dispenser, chrome/black
Schaumseifenspender, chrom/schwarz
Distributeur de savon mousse, chrome/noir
Dispensador de jabón en espuma, cromo/negro

art.	dim. cm.
44178-66	14,2x14,2x28,4

Elettronico. Ricarica igienicamente sigillata. Con sensore ad avanzata tecnologia e pompa nuova fornita con ogni ricarica. Dosi: 0,4 ml. Batterie: 4x D Cell alkaline. - 120.000 erogazioni. - Touch free. Hygienically sealed refill. With advanced sensor dispenser technology and a new pump supplied with every refill. Dose: 0.4ml. One shot Automatic dispensers require 4 x D Cell Alkaline batteries - 120'000 uses.



VASSOI IN MELAMINA
Melamine trays
PAGINA - Page: 372-373

Ricarica sapone in schiuma
Foam refill
Schaumseife-Nachfüllpatrone
Recharge de savon mousse
Recambio de jabón en espuma

art.	dim. cm.	ml.
44178-67	25,5x16x7	1.100

Free'n Clean: Adatto per l'uso nella gestione e trasformazione di prodotti alimentari. Formulazione per pelli sensibili e ideale per lavaggi frequenti. - Suitable for use in food handling and processing. Sensitive skin formulation ideal for frequent hand washing.



Scaletta, PP
Ladder, PP
Leiter, PP
Marche-pied pliable, PP
Escalera plegable, PP

art.	dim. cm.	h.	carico/load
49378-48	48,6x17,2	63	kg.150

Pieghevole, resiste da 0 a 50°C.
Folding, resists from 0 to 50 °C.



Cesto a rete, acciaio verniciato nero
Mesh bin, black painted steel
Netz-Eimer
Corbeille à mailles
Papelera

art.	ø cm.	h.	lt.
44098-29	29	35,6	19



Pattumiera a pedale, PE
Step on bin, PE
Pedaleimer, PE
Poubelle à pédale, PE
Colector a pedal, PE

art.	dim. cm.	h.	lt.
49933-30	49,7x31	56,6	30
49933-50	52,7x34,3	72,0	50
49933-68	56,1x37,3	78,0	68



Contenitore rifiuti, PE SLIM JIM
Waste container, PE
Abfallbehälter, PE
Collecteur, PE
Colector, PE

art.	dim. cm.	h.	lt.
49931-60	59x28	63	60
49931-87	56x28	76	87

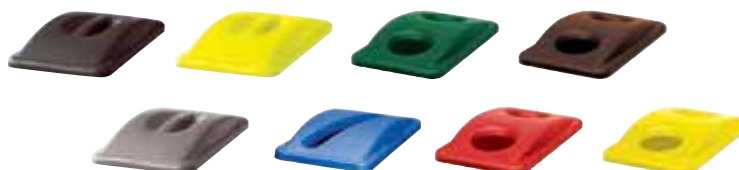

Coperchio, PP
Lid, PP
Deckel, PP
Couvercle, PP
Tapa, PP

art.	dim. cm.	h.	art.	dim. cm.	h.
49931A02	51,8x28,7	7	49931B05	51,8x28,7	7
49931A01	51,8x28,7	7	49931B02	51,8x28,7	7
49931A00	51,8x28,7	7	49931B03	51,8x28,7	7
49931C04	51,8x28,7	7	49931B01	51,8x28,7	7



Coperchio, PP
Lid, PP
Deckel, PP
Couvercle, PP
Tapa, PP

art.	dim. cm.	h.
49931-00	55,6x34,1	3,1

ancorato/hinged



Carrello, PP
Dolly, PP
Transportwagen, PP
Chariot, PP
Carrito, PP

art.	dim. cm.	h.
49931-64	60,6x37,4	21,2



Aggancio laterale a clip che permette di trainare insieme diversi carrelli. Rilascio a pedale semplice e veloce. - Side clip allows to tow together more trolleys, pedal release fast and simple.



Benna ribaltabile, PE
Tilt truck, PE
Falten Eimerwagen, PE
Benne, PE
Carrito plegable, PE

art.	dim. cm.	h.	lt./kg
49934-04	145x68	86	400/205
49934-06	164x77	97	600/272



Coperchio a doppia apertura, PE
Domed linged lid, PE
Doppel-Deckel, PE
Couvercle double, PE
Tapa doble, PE

art.	dim. cm.	h.
49934-14	132x71	23
49934-16	155x81	23



Fasciatoio da parete, PP
Changing table, PP
Windeln-Tisch, PP
Table à langer, PP
Mesa cambia-pañales, PP

art.	dim. cm.	h.
49336-00	91x71	49,5



Fasciatoio da parete, PP
Changing table, PP
Windeln-Tisch, PP
Table à langer, PP
Mesa cambia-pañales, PP

art.	dim. cm.	h.
49336-02	59,5x87,8	48,3

Applicabile a parete. Portata max in uso 23 kg. - Wall mounting. Rated for continuous use up to 23 kg.



Su richiesta/On demand



Seggiolone, PP
Sturdy chair, PP
Kinderstuhl, PP
Chaise d'enfant, PP
Silla niños, PP

art.	dim. cm.	h.
49337-00	60x60	75,5



Su richiesta/On demand



Assicella, PP
Tray, PP
Tablett, PP
Plateau, PP
Bandeja, PP

art.	dim. cm.	h.
49337-01	29x47	8,3

Impilabile. Prodotto adatto a bambini fino a 3 anni di età o 18 kg di peso. Robusto polipropilene, con protezione antibatterica in Microban. Progettato per garantire stabilità e sicurezza, con sponda di protezione integrata nello stampo. Facile da pulire e molto resistente. - Stackable. Suitable for children up to 3 years old or 18 kg weight. Sturdy polypropylene with Microban antimicrobial protection. Designed to ensure stability and safety, with one piece t-bar and safety harness. Easy to clean and very durable.



Carrello di servizio
Service trolley
Servicewagen
Chariot de service
Carro de habitaciones

art.	dim. cm.	h.	lt.	kg.
44174-24	177x58	107	120+120	26,4

Ruote ø125 mm, 2 portasacco pieghevoli + 2 sacco lt. 120. Prodotto in polipropilene copolimero. - Wheels ø125 mm, 2 bag holders + 2 bags lt. 120. Made in polypropylene copolymer.



Carrello di servizio
Service trolley
Servicewagen
Chariot de service
Carro de habitaciones

art.	dim. cm.	h.	lt.	kg.
44177-12	104x56	130	150	26

Base in polipropilene copolimero, montanti in tubolari in acciaio ø 22 mm, verniciato Rilsan. Ruote ø 125 mm. 3 ripiani legno 50x46 cm. Portasacco+sacco in tela poliestere 100% cm. 55x55x94, capacità lt.150. Polypropylene copolymer base, frame in tubular steel ø 22 mm, Rilsan coated. Wheels ø 125 mm. 3 wooden shelves 50x46 cm. Bag holder + canvas bag 100% polyester cm. 55x55x94, lt. 150.



Carrello portabiancheria
Housekeeping cart for linen collection
Hotelwäschewagen
Chariot d'étage à linge
Carro de recogida de ropa

art.	dim. cm.	h.	lt.	kg.
44176-30	105x55	105	300	12,5

Base in polipropilene copolimero. Montanti tubolari in acciaio ø 22 mm, verniciato Rilsan. Ruote ø 125 mm. Sacco in nylon 210 plastificato. Polypropylene copolymer base. Tubular frame ø 22 mm, Rilsan coated steel. Wheels ø 125 mm. Bag, nylon 210.



Carrello portabiancheria
Housekeeping cart for linen collection
Hotelwäschewagen
Chariot d'étage à linge
Carro de recogida de ropa

art.	dim. cm.	h.	lt.	kg.
44175-15	62x60	103	150	6,39

Capiente sacco in tela plasticata lavabile a 30°. Telaio pieghevole. Ruote piroettanti ø80 mm. - Capacious canvas bag laminated washable at 30°. Folding frame. Swivel casters ø80 mm.



Carrello multiuso, PP
Multi-purpose trolley, PP
Allzweckwagen, PP
Chariot multi-usage, PP
Carro de limpieza, PP

art.	dim. cm.	h.	lt.	kg.
44173-00	97x68	111	120	16,8

Ruote ø100 mm, portasacco + sacco lt. 120 e coperchio, vaschetta con ganci, 2 secchi lt. 4, 2 secchi lt. 15 con strizzatore. Wheels ø100 mm, bag holder with cover + bag lt. 120, pan with hooks, 2 buckets lt. 4 and 2 buckets lt. 15 with wringer.



Carrello lavapavimenti con strizzatore, PP
Mopping trolley with press, PP
Wringer Reinigungswagen mit Presse, PP
Chariot de ménage avec presse, PP
Carro con prensa escurridora, PP

art.	dim. cm.	h.	lt.	kg.
44171-24	62x42	90	25	6,4

Ruote ø80 mm con paracolpi, strizzatore e 1 secchio lt. 25. Vano portaoggetti. Impugnatura in PSV completa di rinforzi. Wheels ø80 mm with bumpers, wringer and 25 lt. bucket. With storage compartment. PSV reinforced handle.



Carrello lavapavimenti con strizzatore, PP
Mopping trolley with press, PP
Wringer Reinigungswagen mit Presse, PP
Chariot de ménage avec presse, PP
Carro con prensa escurridora, PP

art.	dim. cm.	h.	lt.	kg.
44171-50	69x42	90	2x25	7,8

Ruote ø 80 mm con paracolpi, strizzatore e 2 secchi da lt. 25. Impugnatura verniciata, reversibile. - Wheels ø 80 mm with bumpers, wringer and 2 buckets lt. 25 each. Painted handle, reversible.



Carrello lavapavimenti con strizzatore, PP
Mopping trolley with press, PP
Wringer Reinigungswagen mit Presse, PP
Chariot de ménage avec presse, PP
Carro con prensa escurridora, PP

art.	dim. cm.	h.	lt.	kg.
44172-30	47x40	93	30	6,3

Monovasca con strizzatore, ruote ø80 mm. con paracolpi. - Single tank with wringer, wheels ø80 mm. with bumpers.



Secchio graduato, PP
Graduated bucket, PP
Eimer mit Skala, PP
Seau gradué, PP
Cubo con medidas, PP

art.	dim. cm.	h.	lt.	kg.
● 44169B06	24,2x18,8	21,5	6	0,48
● 44169R06	24,2x18,8	21,5	6	0,48



Secchio graduato, PP
Graduated bucket, PP
Eimer mit Skala, PP
Seau gradué, PP
Cubo con medidas, PP

art.	dim. cm.	h.	lt.	kg.
● 44169B14	34x33,5	28,3	15	0,78
● 44169R25	37x36,5	31,7	25	0,99



Secchio con strizzatore, PP
Bucket with wringer, PP
Eimer mit Presse, PP
Seau avec essoreur, PP
Cubo con prensa, PP

art.	dim. cm.	h.	lt.	kg.
44168-12	35x27	29,5	12	0,54

Scala graduata da 0 a 12 lt.
Graduated scale from 0 to 12 lt.



Manico per mop, attacco filettato
Cotton mop rod, screw fitting
Mop-Stange mit Schraubanschluss
Manche pour mop avec attache à vis
Mango para fregadora, conexión tornillo

art.	ø cm.	l.
44167-13	2,2	130

In ferro verniciato rosso. Leggero ed inossidabile. - Red lacquered iron. Lightweight and rustproof.



Mop in cotone, attacco filettato
Cotton mop, screw fitting
Baumwollmop mit Schraubanschluss
Mop en coton avec attache à vis
Mopa de algodón

art.	gr.
44166-28	280



Manico telescopico, alluminio
Telescopic rod, aluminum
Teleskopstange, Aluminum
Manche telescopique, aluminum
Mango telescópico, aluminio

art.	ø cm.	l.
44161-00	2,3	97→184

Alluminio anodizzato due pezzi.
Two-piece anodized aluminum rod.



Pinza per mop, PP
Mop holder, PP
Wischnophalter, PP
Pince faubert, PP
Pinza, PP

art.
44164-00

Ghiera universale consente l'utilizzo di qualsiasi manico con ø 20→ø 24 mm.
Universal ring allows the use of any handle with from ø 20 to ø 24 mm.



Mop a strisce in cotone
Cotton-end string mop
Spaghetti-Mop mit Baumwollend
Frange à ficelles en coton
Mopa de algodón

art.	gr.
44165-35	350
44165-40	400
44165-50	500



Scopa a forbice completa
Dust beater "V" sweeper complete
Doppel-Wischmop
Balai double mop
Escoba doble

art. h. cm.
44160-03 135

Apertura 140° circa. Frange in cotone
cm.100. - Opening angle 140° about.
Cotton mops length 100 cm.



Paletta manico lungo
Dustpan
Müllschaufel
Pelle à poussière
Pala

art.
44170-00



Scopa, manico alluminio
Broom, aluminum rod
Besen mit Alustiel
Balai, manche alu
Escoba, mango alumimio

art. ø cm. l.
44170-01 21 80



Cavalletto di segnalazione a 2 lati, PP
2-sided floor sign, PP
2-seitig, Warnschild, PP
Panneau d'avertissement 2 côtés, PP
Señal de suelo 2 lados, PP

art. h. cm.
44077-00 57



Carrello portasacco
Refuse bag holder trolley
Sackhalterwagen
Chariot porte-sac
Colector móvil

art. dim. cm. h. lt. kg.
44089-12 58x56 102 120 6,1



Pattumiera a pedale, PP
Mobile pedal bin
Pedaleimer
Poubelle à pédale
Colector con tapa, abertura pedal

art. dim. cm. h. lt.
44095-18 40x65 81 80



Pattumiera a pedale, PE-HD
Step-on bin
Pedaleimer
Poubelle à pédale
Colector a pedal

art. dim. cm. h. lt.
44095-12 48x55 93 120

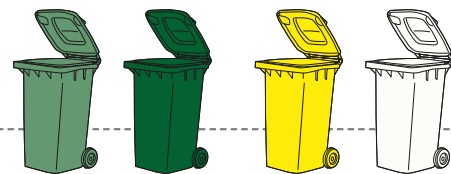
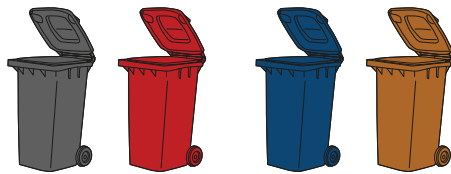

A RICHIESTA ALTRI COLORI - OTHER COLORS UPON REQUEST

Certificata UNI EN 840. Resistente agli agenti chimici, lavabile e sterilizzabile.
Certified UNI EN 840. Withstanding chemical, can be washed and sterilized.



Pattumiera a pedale, PP
Pedal bin, PP
Pedaleimer, PP
Poubelle à pédale, PP
Colector a pedal, PP

art. dim. cm. h. lt. Col.
44096-80 48x50 78 80 ○
44096B80 48x50 78 80 ●●
44096Y80 48x50 78 80 ●●
44096R80 48x50 78 80 ●●
44096G80 48x50 78 80 ●●



Pattumiera a pedale, ignifuga, PP
Pedal bin, fire-proof, PP
Pedaleimer, feuersicher, PP
Poubelle à pédale, ignifugée, PP
Colector a pedal, ignifugo, PP

Coperchi
Lids
Deckel
Couvercles
Tapas

art.	dim. cm.	lt.	col.
49899-01	46x32x80	70	grigio/grey

art.	dim. cm.	col.
49899-91	46x32x80	grigio/grey
49899-92	46x32x80	giallo/yellow
49899-93	46x32x80	verde/green
49899-94	46x32x80	rosso/red
49899-95	46x32x80	blu/blue

Ignifugo a norma di legge. Parti meccaniche in acciaio inox. Angoli arrotondati e superfici lisce. Coperchio staccabile. Si possono impiegare sacchi standard con capacità 70 lt. Apertura del coperchio azionata da pedale. La speciale dinamica di apertura e chiusura del coperchio è in grado di soffocare le fiamme e non consente l'ingresso di aria nuova all'interno del raccogliitore. Fire-proof. All mechanical parts are made in stainless steel. Its rounded off corners and smooth surfaces. The lid can be removed. You can use standard disposable 70 lt bags. Lid opening is operated by pedal. The special opening and closing lid system is able to put out fire and does not allow oxygen to enter into the bin.



Cestino, PP
Waste container
Abfallbehälter
Collecteur
Papelera

Pallet, PE-HD
Pallet
Pallet
Palette
Racks para suelos

Pedana
Dunnage rack
Lageruntersätze
Palettes
Bancada

art.	ø. cm.	h.
44097-00	30	32

art.	dim. cm.	kg.	*kg.
49373-05	80x120x14	4,6	1000

art.	dim. cm.	h.	Load
49371-09	91,4x55,9	30,5	68 kg
49371-12	121,9x55,9	30,5	136 kg

* Carico statico. Per uso alimentare.
* Static load. Appropriate for food.

Materiale polimerico resistente alla ruggine e alla corrosione. - Rust and corrosion-proof polymer material.



Posacenere a colonna, inox
Floor standing ashtray, stainless steel
Standascher/Abfalleimer
Cendrier sur pied, inox
Contenedor con cenicero, inox

Posacenere/pattumiera, inox
Standing ashtray/bin, stainless steel
Standascher/Abfalleimer
Cendrier/poubelle, inox
Cenicero/papelera, inox

Posacenere/fioriera, PP
Standing ashtray, PP
Standascher, PP
Cendrier sur pied, PP
Cenicero, PP

art.	ø cm.	dim.	h.	lt.
49897-09	9	24x24	86	3

art.	ø cm.	h.
49898-30	30	60

art.	ø cm.	h.
49892-40	40	60

Incl. sacchetto sabbia kg 1,5.
Included bag of sand 1,5 kg.

Incl. sacchetto sabbia kg 1,5.
Included bag of sand 1,5 kg.

TABLE TOP SERVICE

TAVOLA
TABLE TOP SERVICE
TISCHSERVICE
SERVICE DE TABLE
SERVICIO DE MESA

VASELLAME INOX 18-10
HOLLOWWARE 18-10 STAINLESS STEEL

Arthur Krupp®





Caffettiera
Coffee pot
Kaffeekanne
Cafetière
Cafetera

Teiera
Tea pot
Teekanne
Théière
Tetera

Lattiera / Cremiera
Milk pot / Creamer
Milchgießer / Gießer
Pot à lait / Crémier
Jarra leche / Jarrita

art.	lt.
66201-03	0,30
66201-06	0,60
66201-09	0,90
66201-16	1,60

art.	lt.
66208-03	0,30
66208-06	0,60
66208-09	0,90

art.	lt.
66204-01	0,15
66206-03	0,30
66206-06	0,60
66206-09	0,90



Brocca acqua
Water jug
Eiswasserkrug
Carafe à eau
Jarra agua

Caraffa termica
Insulated beverage server
Thermokanne
Pot isotherme
Jarra térmica

Caraffa termica
Insulated beverage server
Thermokanne
Pot isotherme
Jarra térmica

art.	lt.
66216-16	1,6

Con ferma ghiaccio. - With ice guard.

art.	lt.
66214-05	0,50
66214-08	0,80

art.	lt.
66215-06	0,60
66215-08	0,80
66215-12	1,20
66215-16	1,60



Ciotolina
Small bowl
Schale
Petite coupelle
Bol

Zuccheriera c/coperchio
Sugar bowl with cover
Zuckerdose mit Deckel
Sucrier avec couvercle
Azucarero con tapa

Zuccheriera
Sugar bowl
Zuckerdose
Sucrier
Azucarero

art.	dim. cm.	h.
66290-25	11,5x9,5	3,5

art.	dim. cm.	h.
66210-25	9,5x7	5

art.	dim. cm.	h.
66210-05	9,5x7	5



Lattiera/teiera
Milk pot/tea pot
Milchgießer/Teekanne
Pot à lait/théière
Jarra leche/tetera

art.	lt.
66303-01	0,15
66303-03	0,30
66303-06	0,60



Lattiera cappuccino
Cappuccino milk pot
Capuccino-Milchkanne
Pot à cappuccino
Jarra cappuccino

art.	lt.
66307-06	0,60
66307-09	0,90
66307-12	1,20



Porta cucchiaini
Spoon holder
Kaffeelöffelbehälter
Porte cuillères
Porta cucharas

art.	ø cm.	h.
66313-03	6	9



Porta cannuce
Straw holder
Röhrchenbehälter
Porte chalumeaux
Porta canutillos

art.	ø cm.	h.
66313-06	8	12



Portatovaglioli
Napkin holder
Serviettenhalter
Porte serviettes
Servilletero

art.	dim. cm.	h.
66391-00	10x3	8



Portabustine tè
Tea bag caddy
Teebeutel-Halter
Porte sachet de thé
Contenedor sobres té

art.	dim. cm.	h.
66375-00	12,5x7	4



Portabustine zucchero
Sugar packet holder
Zuckerbeutelchale
Conteneur à sucre
Contenedor sobres azúcar

art.	dim. cm.	h.
66374-00	12,5x6	4



Coppetta
Small bowl
Schale, klein
Petit bol
Copa

art.	ø cm.	h.
66388-10	8	3,5



Cesto pane, ovale
Oval bread basket
Brotschale, oval
Panier à pain, ovale
Cesta pan, oval

art.	dim. cm.	h.
66392-18	18x22	5
66392-22	22x16	5



Portamarmellata
Jam/honey stand
Ständer für Konfitürgläser
Porte confitures
Soporte confituras

art. h. cm.
66367-03 17,5



Portamarmellata
Jam/honey stand
Ständer für Konfitürgläser
Porte confitures
Soporte confituras

art. h. cm.
66367-06 15,5



Alzata dolci, 2 piani
Pastry stand, 2 tiers
Gebäckständer, 2-stufig
Serviteur muet, 2 étages
Soporte dulces, 2 niveles

art. ø cm. h.
66339-02 12-16 20



Sottobicchiere
Glass coaster
Gläser-teller
Sous-verre
Platito bajo vasos

art. ø cm.
66359-10 10



Sottobottiglia
Bottle coaster
Flaschenteller
Sous bouteille
Platito bajo botellas

art. ø cm.
66359-12 12



Piattino pane
Bread dish
Brotteller
Petite plat à pain
Plato para pan

art. ø cm.
66392-16 16



Piatto presentazione
Show plate
Platzteller
Plat de présentation
Plato de presentación

art. ø cm.
66332-32 32



Porta olio/aceto
Oil and winegar stand
Essig u. Öl-Stand
Porte huile et vinaigre
Soporte para aceite y vinagre

art. dim. cm. h.
66362-02 12,5x6 27



Copripiatto
Plate cover
Tellerlocke
Cloche
Cubreplatos

art. ø cm.
66340-19 19,0
66340-20 20,0
66340-24 24,0
66340-25 25,0
66340-26 26,0
66340-76 26,5
66340-27 27,0
66340-77 27,5
66340-28 28,0
66340-78 28,5
66340-29 29,0
66340-79 29,5
66340-30 30,0
66340-31 31,0
66340-32 32,0
66340-83 33,5



Set porta conto, inox 18 Cr
Bill Holder, 18 Cr stainless steel
Rechnungshalter
Porte-addition, inox 18 Cr
Porta facturas, acero 18 Cr

art. dim. cm.
66318-39 20x16



Vassoio conto, inox 18 Cr
Cash tray, 18 Cr stainless steel
Rechnungstablent, Edelstahl 18 Cr
Plateau porte-monnaie, inox 18 Cr
Bandeja cuentas, acero 18 Cr

art. dim. cm.
66318-19 19x14
66318-22 22x15

SERIES 663

TAVOLA TABLE TOP ARTHUR KRUPP VASELLAME HOLLOWARE



Vassoio conto con molla, inox 18 Cr
Cash tray with spring, 18 Cr stainless steel
Rechnungstablett mit Feder, Edelstahl 18 Cr
Porte note avec pince, inox 18 Cr
Bandeja cuentas con resorte, acero 18 Cr

art.	dim. cm.
66318-29	19x14



Piatto pesce
Fish dish
Fischplatte
Plat à poisson
Bandeja pescado

art.	dim. cm.
66345-55	55x23
66345-65	65x27
66345-74	74x29



Vassoio
Tray
Tablett
Plateau
Bandeja

art.	dim. cm.
66324-40	40x26
66324-50	50x38
66324-65	65x50
56024-85	85x50
56024-99	100x50



Vassoio
Tray
Tablett
Plateau
Bandeja

art.	dim. cm.
66320-28	28x20
66320-35	35x30
66320-40	40x26
66320-50	50x38
66320-65	65x50
56020-85	85x50
56020-99	100x50



BONE CHINA N

Arthur Krupp®
B O N E C H I N A



La professionalità Arthur Krupp e la raffinatezza della fine bone china riunite in una collezione fresca e candida. Neve deve la propria elegante purezza alla semplicità e alla morbidezza delle sue linee, in equilibrio tra le ampie falde di piatti e coppe e la rotondità dell'assortita caffetteria. La qualità, la trasparenza e lo spessore degli articoli concorrono a esaltare preparazioni culinarie di esigenti chef e a contraddistinguere buffet per eleganza e praticità, grazie anche all'impilabilità dei suoi pezzi.

Arthur Krupp's professionalism and the charm of fine bone china creates a fresh and pure collection. Neve's elegant and simple lines provide a soft balance between the wide-rimmed plates and bowls and the roundness of the coffee ware. The quality, transparency and thickness of the articles exalt culinary preparations of demanding chefs and help buffets stand out, thanks to the stackable pieces.



Piatto piano
Flat plate
Teller flach
Assiette plate
Plato llano

art.	ø cm.
67101-01	17,0
67101-02	18,5
67101-03	20,0
67101-04	25,0
67101-05	27,0
67101-06	31,0



Piatto fondo
Soup plate
Teller tief
Assiette creuse
Plato hondo

art.	ø cm.
67101-09	22
67101-10	24
67101-11	30



Piatto ovale
Oval meat dish
Platte oval
Plat oval
Plato oval

art.	dim. cm.
67101-29	25
67101-30	30
67101-31	36



Coppa
Bowl
Schüssel
Bol
Bol

art.	ø cm.
67101-80	8
67101-81	12
67101-82	15



Insalatiera
Salad bowl
Schüssel
Saladier
Bol ensalada

art.	ø cm.
67101-83	20
67101-84	24
67101-85	26



Tazza brodo con maniglie
Soup bowl with handles
Suppentasse mit Griffen
Bol à soupe avec anses
Bol/taza sopa con asas

art.	lt.
67101-23	0,25



Piattino
Saucer
Untertasse
Soucoupe
Platillo

art.
67101-19



Tazza impilabile
Coffee cup stackable
Obertasse stapelbar
Tasse empilable
Taza apilable

art.	lt.
67101-40	0,10



Piattino
Saucer
Untertasse
Soucoupe
Platillo

art.	ø cm.
67101-16	13



Tazza impilabile
Coffee cup stackable
Obertasse stapelbar
Tasse empilable
Taza apilable

art.	lt.
67101-41	0,18



Piattino
Saucer
Untertasse
Soucoupe
Platillo

art.	ø cm.
67101-17	15



Tazza impilabile
Coffee cup stackable
Obertasse stapelbar
Tasse empilable
Taza apilable

art. lt.
67101-45 0,22



Piattino
Saucer
Untertasse
Soucoupe
Platillo

art. cm.
67101-17 15



Zuccheriera senza coperchio
Sugar bowl without lid
Zuckerdose ohne Deckel
Sucrier sans couvercle
Azucarera sin tapa

art. lt.
67101-62 0,15



Coperchio
Lid
Deckel
Couvercle
Tapa

art.
67101-63



Caffettiera senza coperchio
Coffee pot without lid
Kaffeekannen-Unterteil
Cafetière sans couvercle
Cafetera sin tapa

art. lt.
67101-49 0,3
67101-51 0,6



Coperchio
Lid
Deckel
Couvercle
Tapa

art.
67101-50
67101-52



Teiera senza coperchio
Teapot without lid
Teekannen-Unterteil
Théière sans couvercle
Tetera sin tapa

art. lt.
67101-53 0,4
67101-55 0,7



Coperchio
Lid
Deckel
Couvercle
Tapa

art.
67101-54
67101-56



Cremera
Creamer
Gießer
Crémier
Cremera

art. lt.
67101-57 0,03



Lattiera
Milk pot
Gießer
Crémier
Cremera

art. lt.
67101-58 0,15
67101-59 0,30



Spargipepe
Pepper shaker
Pfefferstreuer
Poivrier
Pimentero

art.
67101-97



Spargisale
Salt shaker
Salzstreuer
Salière
Salero

art.
67101-96

PORCELLANA - PORCELAIN

Arthur Krupp®
PORCELAIN



Arthur Krupp® Porcelain — Made in Germany — presenta un assortimento di articoli in porcellana, una gamma professionale pensata per tutte le occasioni d'utilizzo del settore Ho.Re. Ca., dalle mise en place formali ed eleganti a quelle all'insegna dei mix and match più creativi fino a raffinati banchetti e buffet. La qualità del materiale utilizzato, unitamente agli spessori rinforzati, rende queste porcellane estremamente resistenti a urti e rotture, conferendo loro caratteristiche di praticità e durevolezza. Ideali per un utilizzo quotidiano e duraturo.

Arthur Krupp® Porcelain - Made in Germany - introduces a comprehensive range of items in porcelain, a wide selection of professional products designed to meet any needs of the Ho.Re.Ca. sector. Whether classic and elegant mise en place, a creative mix and match, or for a refined buffet, AKP is the right solution. The high-quality materials and the reinforced edges make these items extremely resistant against chipping, giving them the distinctive features of versatility and durability for daily use.



Piatto piano
Flat plate
Teller flach
Assiette plate
Plato llano

Piatto fondo
Soup plate
Teller tief
Assiette creuse
Plato hondo

Piatto ovale
Oval meat dish
Platte oval
Plat oval
Plato oval

art.	ø cm.
67308-01	16
67308-02	19
67308-03	22
67308-04	25
67308-05	28
67308-06	31

art.	ø cm.
67308-09	21
67308-10	24
67308-11	30

art.	dim. cm.
67308-29	26x20,5
67308-30	32x25,5
67308-31	38x30,5



Coppa
Bowl
Schüssel
Bol
Bol

Insalatiera
Salad bowl
Schüssel
Saladier
Bol ensalada

Candeliera
Candleholder
Leuchter
Bougeoir
Candelabro

art.	ø cm.	h.
67308-80	8	5,0
67308-81	11	8,5
67308-82	13	8,0

art.	ø cm.	h.
67308-68	21	10,0
67308-69	25	12,0
67308-70	28	14,5

art.	ø cm.	h.
67308-87	8,5	24





Tazza
Cup
Obertasse
Tasse
Taza

art. ø cm. h. lt.
67308-40 6,5 5,5 0,10



Piattino
Saucer
Untertasse
Soucoupe
Platillo

art. cm.
67308-16 12



Tazza
Cup
Obertasse
Tasse
Taza

art. ø cm. h. lt.
67308-41 8 6,5 0,18



Piattino
Saucer
Untertasse
Soucoupe
Platillo

art. cm.
67308-17 15



Tazza
Cup
Obertasse
Tasse
Taza

art. ø cm. h. lt.
67308-45 8,5 7 0,22



Piattino
Saucer
Untertasse
Soucoupe
Platillo

art. cm.
67308-17 15



Zuccheriera senza coperchio
Sugar bowl without lid
Zuckerdose ohne Deckel
Sucrier sans couvercle
Azucarera sin tapa

art. ø cm. h. lt.
67308-62 8 6 0,15



Coperchio
Lid
Deckel
Couvercle
Tapa

art. ø cm. h.
67308-63 6,5 2,5



Caffettiera senza coperchio
Coffee pot without lid
Kaffeekannen-Unterteil
Cafetière sans couvercle
Cafetera sin tapa

art. dim. cm. h. lt.
67308-49 13x8 11 0,30



Coperchio
Lid
Deckel
Couvercle
Tapa

art. ø cm. h.
67308-50 6 3,5



Teiera senza coperchio
Teapot without lid
Teekannen-Unterteil
Théière sans couvercle
Tetera sin tapa

art. dim. cm. h. lt.
67308-53 15x10 9,5 0,40



Coperchio
Lid
Deckel
Couvercle
Tapa

art. ø cm. h.
67308-54 8 3,5



Lattiera
Milk pot
Gießler
Crémier
Cremera

art. dim. cm. h. lt.
67308-58 10,5x6 9 0,15
67308-59 13x8 11 0,30



Cremera
Creamer
Gießler
Crémier
Cremera

art. dim. cm. h. lt.
67308-57 5x4 5,5 0,03



Luce da tavola
Table light
Tischlicht
Lampe à bougie
Porta-vela

art. ø cm. h.
67308-67 7 6



Piatto piano
Flat plate
Teller flach
Assiette plate
Plato llano

Piatto fondo
Soup plate
Teller tief
Assiette creuse
Plato hondo

Piatto ovale
Oval meat dish
Platte oval
Plat oval
Plato oval

art.	ø cm.
67303-01	16
67303-02	19
67303-03	22
67303-04	25
67303-05	27
67303-06	30

art.	ø cm.
67303-09	21
67303-10	26
67303-11	30

art.	dim. cm.
67303-29	30x20
67303-30	35x25



Coppa
Bowl
Schüssel
Bol
Bol

Insalatiera
Salad bowl
Schüssel
Saladier
Bol ensalada

Tazza brodo
Soup bowl
Suppentasse
Bol à soupe
Bol/taza sopa

Piattino combi
Combi saucer
Kombi Untertasse
Soucoupe
Platillo

art.	ø cm.	h.
67303-77	12	4
67303-80	12	5
67303-81	15	6
67303-82	17	7

art.	ø cm.	h.
67303-85	35,5	13,5

art.	ø cm.	h.	lt.	art.	ø cm.
67303-22	10	5	0,25	67303-19	17



Tazza brodo con maniglie
Soup bowl with handles
Suppentasse mit Griffen
Bol à soupe avec anses
Bol/taza sopa con asas

Piattino combi
Combi saucer
Kombi Untertasse
Soucoupe
Platillo

Salsiera
Sauce boat
Sauciere
Saucière
Salsera

Piattino salsa
Sauce plate
Dipschale
Assiette à sauce
Platillo salsa

art.	ø cm.	h.	lt.	art.	ø cm.
67303-23	10	5	0,25	67303-19	17

art.	lt.
67303-78	0,30
67303-79	0,20

art.	ø cm.	h.
67303-20	9	1,5



Spargipepe
Pepper shaker
Pfefferstreuer
Poirvrièr
Pimentero

Spargisale
Salt shaker
Salzstreuer
Salière
Salero

Portastecchi
Tooth pick holder
Zahnstocher-Halter
Porte cure-dents
Palillero

Vasetto fiori
Flower vase
Blumenvase
Vase à fl eurs
Florero

Porta bustine zucchero/tè
Sugar/tea packet holder
Tee/Zuckerpäckchen-Halter
Porte-sachet de sucre/thé
Contenedor sobres azúcar/té

art.	ø cm.	h.
67303-97	4	6

art.	ø cm.	h.
67303-96	4	6

art.	ø cm.	h.
67303-98	4	7

art.	ø cm.	h.
67303-86	6,5	10

art.	dim cm.	h.
67303-64	11x6	4



Tazza impilabile
Coffee cup stackable
Obertasse stapelbar
Tasse empilable
Taza apilable

art. ø cm. h. lt.
67303-40 6 6 0,10



Piattino
Saucer
Untertasse
Soucoupe
Platillo

art. cm.
67303-16 12



Tazza impilabile
Coffee cup stackable
Obertasse stapelbar
Tasse empilable
Taza apilable

art. ø cm. h. lt.
67303-41 7,5 7 0,18



Piattino
Saucer
Untertasse
Soucoupe
Platillo

art. cm.
67303-17 15



Tazza
Cup
Obertasse
Tasse
Taza

art. ø cm. h. lt.
67303-45 7,5 8 0,22



Piattino
Saucer
Untertasse
Soucoupe
Platillo

art. cm.
67303-17 15



Zuccheriera senza coperchio
Sugar bowl without lid
Zuckerdose ohne Deckel
Sucrier sans couvercle
Azucarera sin tapa

art. ø cm. h.
67303-62 7,5 8



Coperchio
Lid
Deckel
Couvercle
Tapa

art. ø cm.
67303-63 7,5



Caffettiera senza coperchio
Coffee pot without lid
Kaffeekannen-Unterteil
Cafetière sans couvercle
Cafetera sin tapa

art. ø cm. h. lt.
67303-49 8,5 12 0,30
67303-51 10,0 16 0,60



Coperchio
Lid
Deckel
Couvercle
Tapa

art. ø cm.
67303-50 7,5
67303-52 9,0



Teiera senza coperchio
Teapot without lid
Teekannen-Unterteil
Théière sans couvercle
Tetera sin tapa

art. ø cm. h. lt.
67303-53 12 9 0,40
67303-55 15 11 0,70



Coperchio
Lid
Deckel
Couvercle
Tapa

art. ø cm.
67303-54 7,5
67303-56 9,0



Lattiera
Milk pot
Gießler
Crémier
Cremera

art. ø cm. h. lt.
67303-58 7 8 0,15
67303-59 8 11 0,30



Cremera
Creamer
Gießler
Crémier
Cremera

art. ø cm. h. lt.
67303-57 4,5 5 0,03



Mug con manico
Mug with handle
Becher mit Henkel
Gobelet avec anse
Mug con asa

art. ø cm. h. lt.
67303-44 7,5 9 0,25



Ciotolina "Seesaw"
Small dish "Seesaw"
Schale "Seesaw"
Petite assiette "Seesaw"
Platillo "Seesaw"

art.	dim. cm.	h.
67303M01	9x7	3



Piattino "Gondola"
Small dish "Gondola"
Schale "Gondola"
Petite assiette "Gondola"
Platillo "Gondola"

art.	dim. cm.	h.
67303M02	14x7	2



Piattino "Trident"
Small dish "Trident"
Schale "Trident"
Petite assiette "Trident"
Platillo "Trident"

art.	ø cm.	h.
67303M03	10	2



Piattino "Rondel"
Small dish "Rondel"
Schale "Rondel"
Petite assiette "Rondel"
Platillo "Rondel"

art.	ø cm.	h.
67303M04	10,5	2



Ciotolina "Coppetta"
Small dish "Coppetta"
Kleine Schale "Coppetta"
Petite assiette "Coppetta"
Platillo "Coppetta"

art.	dim. cm.
67303M05	11x8
67303M06	16x11



Cucchiaio cinese
Chinese spoon
Porzellanlöffel
Cuillère chinoise
Cucharita

art.	l. cm.
67303M07	13



OMNIA SQUARE

TAVOLA TABLE TOP
ARTHUR KRUPP PORCELAIN



Piatto piano quadro
Flat square plate
Teller flach quadratisch
Assiette plate carrée
Plato llano cuadrado

art.	dim. cm.
67303Q01	23x23
67303Q02	28x28



Piatto fondo quadro
Deep square plate
Teller tief quadratisch
Assiette creuse carrée
Plato hondo cuadrado

art.	dim. cm.
67303Q10	23x23



Piattino piano quadrato
Flat square plate
Teller flach quadratisch
Petite assiette plate carrée
Platillo llano cuadrado

art.	dim. cm.
67303Q80	9x9
67303Q81	12x12



Piattino fondo quadrato
Deep square plate
Teller tief quadratisch
Petite assiette creuse carrée
Platillo hondo cuadrado

art.	dim. cm.
67303Q82	9x9
67303Q83	12x12



Piatto rettangolare
Rectangular plate
Platte rechteckig
Assiette rectangulaire
Plato rectangular

art.	dim. cm.
67303Q29	18x11
67303Q30	29x19



Ciotola quadra
Squared bowl
Schüssel rechteckig
Bol carré
Bol cuadrado

art.	dim. cm.
67303Q84	23x23



Ciotola Quadra
Squared Bowl
Schüssel Rechteckig
Bol Carré
Bol Cuadrado

art.	dim. cm.	h.
67303Q85	30x30	11





Piatto piano
Flat plate
Teller flach
Assiette plate
Plato llano

Piatto fondo
Soup plate
Teller tief
Assiette creuse
Plato hondo

Piatto ovale
Oval meat dish
Platte oval
Plat oval
Plato oval

art.	ø cm.
67305-01	16
67305-02	21
67305-03	25
67305-04	28
67305-05	33
67305-06	31

art.	ø cm.
67305-09	17
67305-10	22
67305-11	28

art.	dim. cm.
67305-29	24x20
67305-30	28x24
67305-31	34x29



Tazza brodo
Soup bowl
Suppentasse
Bol à soupe
Bol/taza sopa

Piattino
Coffee saucer
Untertasse
Soucoupe
Platillo

Tazza brodo con maniglie
Soup bowl with handles
Suppentasse mit Griffen
Bol à soupe avec anses
Bol/taza sopa con asas

Piattino
Coffee saucer
Untertasse
Soucoupe
Platillo

art.	ø cm.	h.	lt.
67305-22	12	6	0,30

art.	ø cm.
67305-19	18

art.	ø cm.	h.	lt.
67305-23	12	6	0,30

art.	ø cm.
67305-19	18



Coppa
Bowl
Schüssel
Bol
Bol

Coppa alta
Deep bowl
Schüssel tief
Bol
Bol

Salsiera
Sauce boat
Sauciere
Saucière
Salsera

art.	ø cm.	h.
67305-80	12	8
67305-81	15	7
67305-82	20	8
67305-83	27	10

art.	ø cm.	h.
67305-84	20	12

art.	ø cm.	h.	lt.
67305-78	12	8	0,50
67305-79	10	6	0,25

ROTONDO

**TAVOLA TABLE TOP
ARTHUR KRUPP PORCELAIN**



Tazza impilabile
Coffee cup stackable
Obertasse stapelbar
Tasse empilable
Taza apilable

art. ø cm. h. lt.
67305-40 6,5 5 0,10



Piattino
Saucer
Untertasse
Soucoupe
Platillo

art. cm.
67305-15 13



Tazza impilabile
Coffee cup stackable
Obertasse stapelbar
Tasse empilable
Taza apilable

art. ø cm. h. lt.
67305-41 8,5 6 0,18



Piattino
Saucer
Untertasse
Soucoupe
Platillo

art. cm.
67305-17 15



Tazza impilabile
Coffee cup stackable
Obertasse stapelbar
Tasse empilable
Taza apilable

art. ø cm. h. lt.
67305-45 8,5 7 0,22



Piattino
Saucer
Untertasse
Soucoupe
Platillo

art. cm.
67305-17 15



Zuccheriera senza coperchio
Sugar bowl without lid
Zuckerdose ohne Deckel
Sucrier sans couvercle
Azucarera sin tapa

art. ø cm. h. lt.
67305-62 10 7 0,28



Coperchio
Lid
Deckel
Couvercle
Tapa

art. ø cm. h.
67305-63 10,5 1



Caffettiera senza coperchio
Coffee pot without lid
Kaffeekannen-Unterteil
Cafetière sans couvercle
Cafetera sin tapa

art. ø cm. h. lt.
67305-49 10 7 0,30
67305-51 19 10 0,60



Coperchio
Lid
Deckel
Couvercle
Tapa

art. ø cm. h.
67305-50 8 2,5



Teiera senza coperchio
Teapot without lid
Teekannen-Unterteil
Théière sans couvercle
Tetera sin tapa

art. ø cm. h. lt.
67305-53 12 8 0,40
67305-55 14 10 0,70



Coperchio
Lid
Deckel
Couvercle
Tapa

art. ø cm. h.
67305-54 9,5 2,5
67305-56 9,0 3,0



Cremiera
Creamer
Gießer
Crémier
Cremera

art. ø cm. h. lt.
67305-57 7 11 0,20



Mug con manico
Mug with handle
Becher mit Henkel
Gobelet avec anse
Mug con asa

art. ø cm. h. lt.
67305-44 8,5 10 0,30



POSATERIA - *FLATWARE*

Arthur Krupp®

VINTAGE

VINTAGE ON 18/10 STAINLESS STEEL

L'attraente superficie "Vintage" è un omaggio ai grandi classici e progetti iconici di design di Sambonet. Si tratta di una particolare lavorazione meccanica di finitura di massa del substrato delle posate in acciaio inox. Mediante una serie di processi industriali di natura abrasiva le superfici assumono una inedita resa, un effetto volutamente "usurato", che introduce un nuovo ed affascinante gusto in tavola e di tendenza per l'interior design contemporaneo.

The captivating "Vintage" collection is a tribute to Sambonet's great s and iconic design projects. It uses a special craftsman finishing technique on the surface of the stainless steel flatware. Through a series of industrial scraping processes, surfaces assume an original and intentionally "worn out" effect, introducing a new and fascinating ambience at the table and a new trend for contemporary interior design.

VINTAGE PVD

VINTAGE ON PVD 18/10 STAINLESS STEEL

Texture e colore possono essere combinate tra loro, per ricercare anche in tavola il proprio stile. In questi casi i processi si articolano in più fasi produttive che si susseguono partendo dalla lavorazione con le differenti tecniche abrasive dello strato superficiale per poi passare alla sua colorazione. Il mix tra queste due lavorazioni dona così inediti effetti alle collezioni.

Texture and colour can be combined together, in order to find a personal style on the tabletop. In this case the processes take place in consecutive phases, from the different abrasive techniques to the colouring ones. Combining these two treatments, flatware assume original effects.

PVD

PVD ON 18/10 STAINLESS STEEL

Il PVD è un processo che conferisce agli oggetti pregiate colorazioni e sfumature, ed è ottenuto dalla deposizione di particelle metalliche mediante vaporizzazione in una camera sottovuoto. Questo particolare rivestimento si salda a livello atomico al substrato in acciaio inox delle posate, dotando il materiale di maggiore durezza e di resistenza sia all'usura per sfregamento che alla corrosione, inibendo la formazione di ruggini o ossidi. Un processo che dà vita alle esclusive colorazioni Black, Copper, Gold e Champagne.

PVD is a technique which colors and shades valuable objects by evaporating metal particles in a vacuum chamber. This special treatment is welded at an atomic level to the surface of the stainless steel flatware, hardening the steel and optimizing its resistance to both rubbing and corrosion, as well as preventing rust and oxides from forming. A process that generates the Black, Copper, Gold and Champagne exclusive colours.

ANTIQUE PVD

ANTIQUE ON PVD 18/10 STAINLESS STEEL

Il particolarissimo effetto "Antique" si caratterizza per una sottile texture piacevole al tatto e, nel contempo, per l'inedita resa opaca che assume l'acciaio. La finitura è il risultato di un trattamento di sabbiatura ad alta pressione mediante microparticelle in ceramica, che definisce l'effetto finale delle superfici. Texture e colore possono essere combinate tra loro, per ricercare anche in tavola il proprio stile. In questi casi i processi si articolano in più fasi produttive che si susseguono partendo dalla lavorazione con le differenti tecniche abrasive dello strato superficiale per poi passare alla sua colorazione. Il mix tra queste due lavorazioni dona così inediti effetti alle collezioni.

The particular "Antique" finishing is characterized by the pleasant to touch texture and the original matt appearance of the stainless steel. This finish is the result of an high pressure ceramics sandblasting treatment, made up of micro ceramic particles, which defines the final effect of the surfaces. Texture and colour can be combined together, in order to find a personal style on the tabletop. In this case the processes take place in consecutive phases, from the different abrasive techniques to the colouring ones. Combining these two treatments, flatware assume original effects.



ACCIAIO INOSSIDABILE 18-10
18-10 STAINLESS STEEL



ACCIAIO INOSSIDABILE 18-10 ARGENTATO
ELECTROSILVERPLATED 18-10 STAINLESS STEEL



ACCIAIO INOSSIDABILE 18-10 VINTAGE
VINTAGE 18-10 STAINLESS STEEL



ACCIAIO INOSSIDABILE 18-10 PVD NERO
BLACK PVD 18-10 STAINLESS STEEL



ACCIAIO INOSSIDABILE 18-10 PVD RAME
COPPER PVD 18-10 STAINLESS STEEL



ACCIAIO INOSSIDABILE 18-10 PVD ORO
GOLD PVD 18-10 STAINLESS STEEL



ACCIAIO INOSSIDABILE 18-10 PVD CHAMPAGNE
CHAMPAGNE PVD 18-10 STAINLESS STEEL



ACCIAIO INOSSIDABILE 18-10 VINTAGE PVD RAME
VINTAGE COPPER PVD 18-10 STAINLESS STEEL



ACCIAIO INOSSIDABILE 18-10 VINTAGE PVD ORO
VINTAGE GOLD PVD 18-10 STAINLESS STEEL



ACCIAIO INOSSIDABILE 18-10 ANTIQUE PVD NERO
ANTIQUE BLACK PVD 18-10 STAINLESS STEEL



ACCIAIO INOSSIDABILE 18-10 ANTIQUE PVD CHAMPAGNE
ANTIQUE CHAMPAGNE PVD 18-10 STAINLESS STEEL

Legenda - Key

Le sagome delle posate sono puramente indicative.
The flatware shapes are only representatives.

Tutti i coltelli hanno la lama seghettata.
All knives with serrated blade.

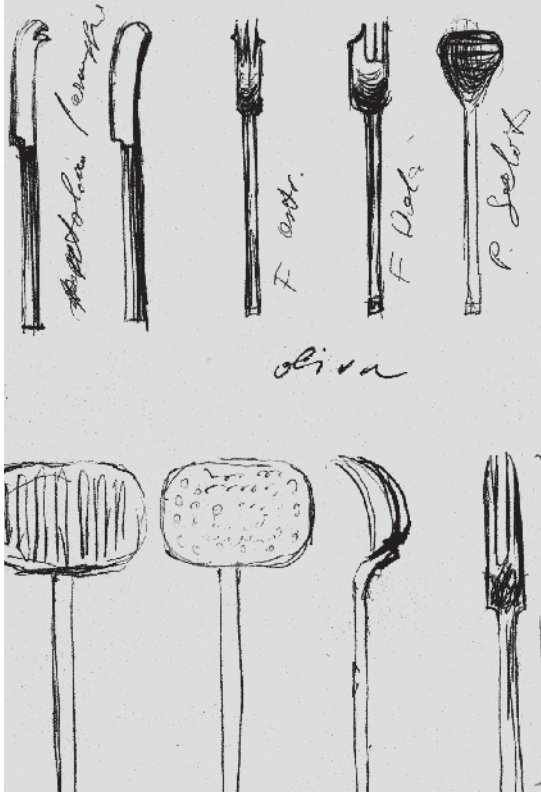

Art.		
-01	Cucchiaino tavola	Table spoon
-08	Forchetta tavola	Table fork
-11	Coltello tavola, monoblocco	Table knife, s.h.
-15	Coltello tavola, manico cavo	Table knife, h.h.
-25	Cucchiaino frutta	Dessert spoon
-26	Forchetta frutta	Dessert fork
-27	Coltello frutta, monoblocco	Dessert knife, s.h.
-31	Coltello frutta, manico cavo	Dessert knife, h.h.
-36	Cucchiaino thè	Tea/coffee spoon
-37	Cucchiaino moka	Moka spoon
-40	Mestolo	Soup ladle
-44	Cucchiaino legumi	Serving spoon
-45	Forchetta legumi	Serving fork
-49	Forchetta pesce	Fish fork
-50	Coltello pesce	Fish knife
-55	Forchetta dolce	Cake cutting fork
-57	Paletta gelato	Ice cream spoon
-58	Pala torta	Cake server
-67	Cucchiaino bibita	Iced tea spoon
-69	Cucchiaino salsa	French sauce spoon
-02	Cucchiaino brodo	Bouillon spoon
-70	Spatola burro	Butter spreader
-73	Coltello burro, monoblocco	Butter knife, s.h.
-72	Coltello burro, m. cavo	Butter knife, h.h.
-18	Coltello burro bimbo, monoblocco	Butter knife, small, s.h.
-16	Coltello burro bimbo, m.cavo	Butter knife, small, h.h.
-19	Coltello bistecca, monoblocco	Steak knife, s.h.
-21	Coltello bistecca, m. cavo	Steak knife, h.h.



Cream

Acciaio inossidabile 18-10
18-10 Stainless steel
62511

Acciaio inossidabile 18-10 argentato
Electrosilverplated 18-10 stainless steel
62711

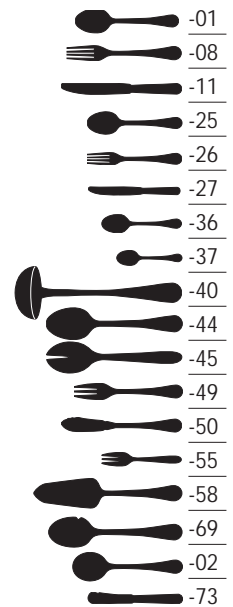

* pack appendibile su richiesta
Hanging packaging on demand

- 62411-
- 62711B
- 62711C
- 62711G
- 62711P
- 62411C
- 62411G
- 62111B
- 62111C



-
-
-
-
-
-
-
-
-

Baguette

Acciaio inossidabile 18-10
18-10 Stainless steel
62612

Acciaio inossidabile 18-10 argentato
Electrosilverplated 18-10 stainless steel
62812



- 01
- 08
- 11
- 15
- 25
- 26
- 27
- 31
- 36
- 37
- 40
- 44
- 45
- 49
- 50
- 55
- 57
- 58
- 67
- 69
- 02
- 70
- 73
- 72
- 18
- 16
- 19
- 21



-
-
-
-
-
-
-
-
-

Contour

Acciaio inossidabile 18-10
18-10 Stainless steel
62611

Acciaio inossidabile 18-10 argentato
Electrosilverplated 18-10 stainless steel
62811



- 01
- 08
- 11
- 15
- 25
- 26
- 27
- 31
- 36
- 37
- 40
- 44
- 45
- 49
- 50
- 55
- 57
- 58
- 67
- 69
- 02
- 70
- 73
- 72
- 18
- 16
- 19
- 21

* pack appendibile su richiesta - Hanging packaging on demand

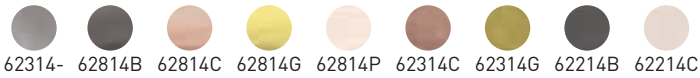

Arcadia

Acciaio inossidabile 18-10
18-10 Stainless steel
62614

Acciaio inossidabile 18-10 argentato
Electrosilverplated 18-10 stainless steel
62814

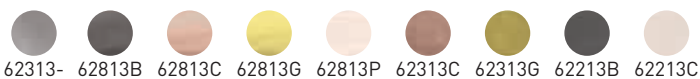
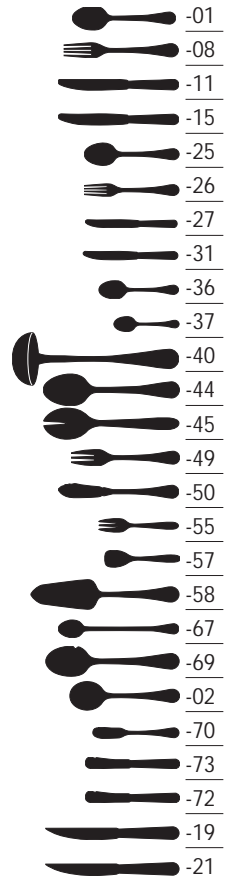

Monika

Acciaio inossidabile 18-10
18-10 Stainless steel
62613

Acciaio inossidabile 18-10 argentato
Electrosilverplated 18-10 stainless steel
62813

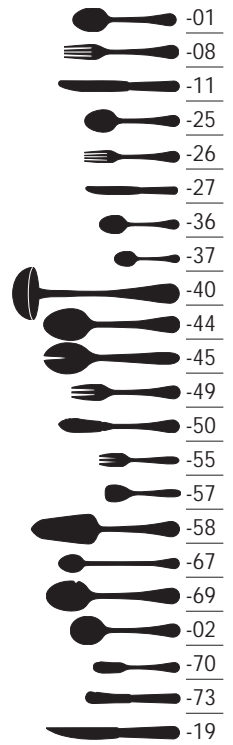

* **pack appendibile su richiesta**
Hanging packaging on demand



- 62315-
- 62815B
- 62815C
- 62815G
- 62815P
- 62315C
- 62315G
- 62215B
- 62215C

London

Acciaio inossidabile 18-10
 18-10 Stainless steel
62615

Acciaio inossidabile 18-10 argentato
 Electrosilverplated 18-10 stainless steel
62815

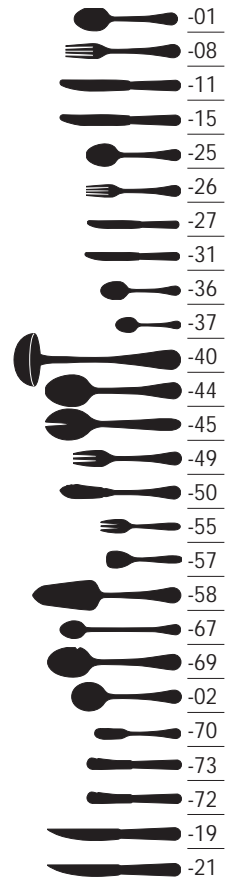

- 62318-
- 62818B
- 62818C
- 62818G
- 62818P
- 62318C
- 62318G
- 62218B
- 62218C

Versailles

Acciaio inossidabile 18-10
 18-10 Stainless steel
62618

Acciaio inossidabile 18-10 argentato
 Electrosilverplated 18-10 stainless steel
62818

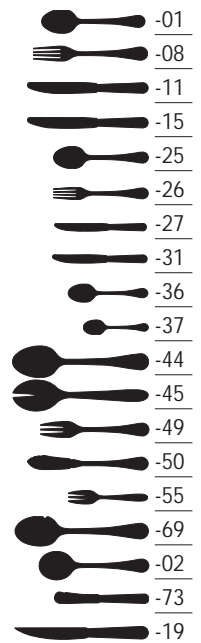

P SERIE LIVING



Una linea completa capace di coniugare assortimento, bellezza, robustezza e funzionalità, realizzata in acciaio inox. Oggetti di qualità per apparecchiare le tavole ed i buffet più raffinati, ma anche per disporre quotidianamente di una cucina super-attrezzata. Il modo più pratico per servire con eleganza e facilità ogni tipo di pietanza dagli spaghetti alla carne, pesce, pane, verdure, formaggi e frutta ma anche piccoli alimenti come dolci, olive e sottaceti. Niente potrà sfuggire inavvertitamente!

A complete stainless steel line, that is able to join assortment, beauty, strenght and functionality. Quality items that can be used in order to set the most charming tables and buffets, but also in order to have a well-equipped kitchen. The easiest way to serve with charm any kind of dishes: from spaghetti to meat, fish, bread, vegetables, cheese and fruit. It is also indicated for tiny preparations such as sweets, olives and pickles. Nothing will unintentionally escape!



Forbice per verdure
Vegetables serving plier
Salad-/Gemüsezange
Pince à légumes
Pinza verduras

art. dim. cm.
52550-81 24



Forbice tutto servire
Serving plier
Servierzange
Pince à servir
Pinza servir

art. dim. cm.
52550-83 21,0
52550-84 26,5
52550-85 24,0



Forbice per torta
Pie plier
Kuchenzange
Pince à tarte
Pinza pasteles

art. dim. cm.
52550-80 28



Forbice per antipasti e dolci
Hors-d'oeuvres and pastry plier
Vorspeisen-/Pâtisseriezange
Pince à hors-d'oeuvres et pâtisserie
Pinza entremeses y pasteles

art. dim. cm.
52550-87 15
52550-89 20



Forbice per dolci
Pastry plier
Gebäckzange
Pince à pâtisserie
Pinza pasteles

art. dim. cm.
52550-88 18



Forbice uva
Grape scissor
Traubenschcher
Ciseaux à rasin
Tijeras uva

art. dim. cm.
52550-91 14,5



Molla per frutta
Fruit tong
Fruchtentzange
Pince à fruits
Pinza frutas

art. dim. cm.
52550-50 23,5



Molla per spaghetti
Spaghetti-tong
Spaghettizange
Pince à spaghetti
Pinza espagueti

art. dim. cm.
52550-73 21
52550-74 30



Molla per toast e dolci
Toast and pastry tong
Toast-/Gebäckzange
Pince à toast et tarte
Pinza pasteles y tostadas

art. dim. cm.
52550-77 21
52550-78 24
52550-79 30



Molla universale
Multipurpose tong
Universalzange
Pince universelle
Pinza universal

art. dim. cm.
52550-58 30



Molla tutto servire
Serving tong
Servierzange
Pince à servir
Pinza asados y verduras

art. dim. cm.
52550-68 21
52550-69 26
52550-70 30



Molla per pane e pasticceria
Bread and pastry tong
Brot-/Gebäckzange
Pince à pain et pâtisserie
Pinza pan y pasteles

art. dim. cm.
52550-62 18
52550-63 23
52550-64 26



Molla per lumache
Snail tong
Schneckenzange
Pince à escargots
Pinza caracoles

art. dim. cm.
52550-60 17



Molla per asparagi
Asparagus tong
Spargelzange
Pince à asperges
Pinza espárragos

art. dim. cm.
52550-66 23



Molla per ghiaccio
Ice tong
Eiszange
Pince à glace
Pinza hielo

art. dim. cm.
52550-56 17,5

TAVOLA TABLE TOP



Molla per zucchero
Sugar tong
Zuckerzange
Pince à sucre
Pinza azúcar

art. dim. cm.
52550-53 12



Molla per zucchero
Sugar tong
Zuckerzange
Pince à sucre
Pinza azúcar

art. dim. cm.
52550-54 12,5



Molla per ghiaccio
Ice tong
Eiszange
Pince à glace
Pinza hielo

art. dim. cm.
52550-55 18,5



Pala torta
Cake server
Tortenheber
Pelle à gâteau
Pala tarta

art. dim. cm.
52550-02 30



Coltello panettone
Panettone knife
Tortenmesser
Couteau à gâteau
Cuchillo tarta

art. dim. cm.
52550-34 32



Forchetta a servire
Serving fork
Serviergabel
Fourchette à servir
Tenedor servir

art. dim. cm.
52550-11 29,5
52550-12 26,0
52550-23 39,0



Cucchiaio a servire
Serving spoon
Servierlöffel
Cuiller à servir
Cuchara servir

art. dim. cm.
52550-13 30,0
52550-14 25,5
52550-22 39,0



Cucchiaio a servire forato
Serving spoon perforated
Servierlöffel, perforiert
Cuiller à servir perforée
Cuchara servir, perforada

art. dim. cm.
52550-24 39,0
52550-25 25,5
52550-26 30,0



Mestolo
Ladle
Schöpfer
Louche
Cazo

art. dim. cm.
52550-01 25,5



Coppino salsa
Sauce ladle
Dressingschöpfer
Louche à sauce
Cazillo salsas

art. dim. cm.
52550-20 16

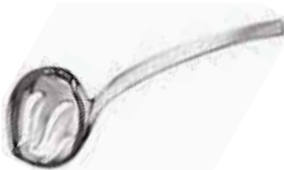

Coppino forato
Perforated sauce ladle
Dressingschöpfer, gelocht
Louche à sauce percée
Cazillo, perforado

art. dim. cm.
52550-21 16,5



Forchettone spaghetti
Spaghetti serving fork
Spaghettivorlegegabel
Fourchette à servir spaghetti
Tenedor servir espagueti

art. dim. cm.
52550-15 28,5



Cucchiaio risotto
Rice ladle
Reislöffel
Cuiller à risotto
Cuchara arroz

art. dim. cm.
52550-16 28



Forchettone
Meat fork
Tranchiergabel
Fourchette
Tenedor

art. dim. cm.
52550-30 32



Cottello arrosto
Roast beef knife
Tranchiermesser
Couteau à rôtis
Cuchillo roastbeef

art. dim. cm.
52550-33 32



Forchetta servire pesce
Fish serving fork
Fischvorlegegabel
Fourchette à servir poisson
Tenedor servir pescado

art. dim. cm.
52550-41 25



Cottello servire pesce
Fish serving knife
Fischvorlegemesser
Couteau à servir poisson
Cuchillo servir pescado

art. dim. cm.
52550-42 25



Spatolina burro, set 6 pz
Butter spreader, 6 pcs set
Butterstreicher, 6 Stk
Tarnineur, 6 pcs
Palita mantequilla, 6 piezas

art. dim. cm.
52550-37 16,5



Cucchiaino sale
Salt spoon
Salzlöffel
Cuiller à sel
Cucharita para sal

art. dim. cm.
52550-17 6,5



Cucchiaio parmigiano
Parmesan spoon
Parmesanlöffel
Cuiller à parmesan
Cucharita parmesano

art. dim. cm.
52550-18 12,5



Cucchiaino moka, set 12 pz
Moka spoon, 12 pcs set
Mokkalöffel
Cuiller à moka
Cucharita moka

art. dim. cm.
62550B28 12,5



Cucchiaino moka, set 12 pz
Moka spoon, 12 pcs set
Mokkalöffel
Cuiller à moka
Cucharita moka

art. dim. cm.
62550B30 12,5



Forchettina aperitivi, set 12 pz
Party fork, 12 pcs set
Party-Gabel
Fourchette apéro
Tenedor party

art. dim. cm.
62550B27 12,5



Forchettina aperitivi, set 12 pz
Party fork, 12 pcs set
Party-Gabel
Fourchette apéro
Tenedor party

art. dim. cm.
62550B29 12,5



Spatolina, set 12 pz
Spreader, 12 pcs set
Butterstreicher, 12 Stk
Tarnineur, 12 pcs
Palita, 12 piezas

art. dim. cm.
62550B31 12,5
62550B32 12,5



Cucchiaio bibita, set 6 pz
Ice tea spoon, 6 pcs set
Limonadenlöffel
Cuillère à soda
Cuchara refresco

art. dim. cm.
52550-36 19,5



TAVOLA TABLE TOP



Forchettina ostriche, set 6 pz
Oyster fork, 6 pcs set
Austerngabel, 6 Stk.
Fourchette à huîtres, 6 pcs
Tenedor ostras, 6 piezas

art. dim. cm.
52550-43 14



Forchetta per lumache
Escargot fork
Schnecken gabel
Fourchette à escargots
Tenedor caracoles

art. dim. cm.
52550-19 14



Cucchiaio bibita, set 6 pz
Ice tea spoon, 6 pcs set
Limonadenlöffel
Cuillère à soda
Cuchara refresco

art. dim. cm.
41605-25 25



Cucchiaio ghiaccio
Ice spoon
Eislöffel
Cuillère à glace
Cuchara hielo

art. dim. cm.
52550-04 22



Cucchiaio salsa
Dressing spoon
Saucenlöffel
Cuillère à sauce
Cuchara salsa

art. dim. cm.
52550-06 22



Cucchiaio monoporzione
Monoportion spoon
Monoporzion-Löffel
Cuillère monoportion
Cuchara monoporción

art. dim. cm.
52550-03 9,5
52550-07 12,0



Forchetta monoporzione
Monoportion fork
Monoporzion-Gabel
Fourchette monoportion
Tenedor monoporción

art. dim. cm.
52550-05 9,5



Forchetta monoporzione
Monoportion fork
Monoporzion-Gabel
Fourchette monoportion
Tenedor monoporción

art. dim. cm.
52550-09 12

COMPLEMENTI *SERVING ITEMS*





N

FINGERFOOD

Porcellana - Porcelain - Porzellan - Porcelaine - Porcelana



art. 41200-07 dim. cm. 7,5x7,5 h. 3



art. 41200-09 dim. cm. 8x8 h. 5



art. 41200-40 ø cm. 7x7 h. 3,5



art. 41200-06 dim. cm. 8x8 h. 2,4



art. 41200-32 dim. cm. 10x10 h. 1,2



art. 41200-05 dim. cm. 8x5,5 h. 1,8



art. 41200-08 dim. cm. 5,2x5,2 h. 4



art. 41200-11 dim. cm. 5,5x4,5 h. 6,5



art. 41200-41 ø cm. 7 h. 4,5



art. 41200-04 dim. cm. 10x5,5 h. 2,7



art. 41200-10 dim. cm. 8x7 h. 3,4



art. 41200-01 dim. cm. 9x5 h. 3



art. 41200-02 dim. cm. 8,1x5,6 h. 3



art. 41200-49 dim. cm. 5x5 h. 5



art. 41200-34 dim. cm. 9,7x6 h. 2,6



art. 41200-03 dim. cm. 8,5x6,8 h. 2



art. 41200-51 dim. cm. 7x7 h. 4,5



art. 41200-50 dim. cm. 6x6 h. 4,5



art. 41200-52 dim. cm. 8x5,5 h. 2,3



art. 41200-33 dim. cm. 10,5x5 h. 1,6



art. 41200-53 dim. cm. 13,5x5,5 h. 5



art. 41200-54 ø cm. 13,5 h. 4



art. 41200-58 ø cm. 13x10 h. 4



art. 41200-16 dim. cm. 10x5,5 h. 4,5



art. 41200-17 dim. cm. 9x3,6 h. 4,5



art. 41200-18 dim. cm. 10,5x7 h. 4,5



art. 41200-13 dim. cm. 10x5,5 h. 4,5



art. 41200-14 dim. cm. 9x3,6 h. 4,5



art. 41200-15 dim. cm. 10,5x7 h. 4,5



art. 41200-59 dim. cm. 14x10 h. 3,5



art. 41200-61 dim. cm. 14x9,5 h. 3,5



art. 41200-63 ø cm. 13 h. 5,5



art. 41200-60 dim. cm. 14x10



art. 41200-62 dim. cm. 14x9,5



art. 41200-64 ø cm. 13



art. 41200-55 dim. cm. 15x10 h. 1,7



art. 41200-56 dim. cm. 22,3x14 h. 2



art. 41200-57 dim. cm. 29,5x20,5 h. 2



art. 41200-46 ø cm. 10 h. 5,0
41200-47 ø cm. 9 h. 5,0
41200-48 ø cm. 8 h. 4,5



art. 41200-36 dim. cm. 10x2,5 h. 1,6



P

Caraffa termica, inox
Insulated beverage server, s/s
Thermokanne, Edelstahl Rostfrei
Pot isotherme, inox
Jarra térmica, inox

art.	lt.
41650-03	0,3
41650-06	0,6
41650-10	1,0
41650-13	1,3



P

Caraffa termica, inox
Insulated beverage server, s/s
Thermokanne, Edelstahl Rostfrei
Pot isotherme, inox
Jarra térmica, inox

art.	lt.
41650B03	0,3
41650B06	0,6
41650B10	1,0
41650B13	1,3



P

Caraffa termica, inox
Insulated beverage server, s/s
Thermokanne, Edelstahl Rostfrei
Pot isotherme, inox
Jarra térmica, inox

art.	lt.
41650R03	0,3
41650R06	0,6
41650R10	1,0
41650R13	1,3



P

Caraffa termica, inox
Insulated beverage server, s/s
Thermokanne, Edelstahl Rostfrei
Pot isotherme, inox
Jarra térmica, inox

art.	lt.
41646-06	0,6
41646-10	1,0
41646-15	1,5
41646-20	2,0



N



Caraffa termica, inox, PP
Insulated beverage server, s/s, PP
Thermokanne, Edelstahl Rostfrei, PP
Pot isotherme, inox, PP
Jarra térmica, inox, PP

art.	ø cm.	h.	lt.	col.
42403-01	16	20	1,0	○



N



Caraffa termica, inox, PP
Insulated beverage server, s/s, PP
Thermokanne, Edelstahl Rostfrei, PP
Pot isotherme, inox, PP
Jarra térmica, inox, PP

art.	ø cm.	h.	lt.	col.
42403B01	16	20	1,0	●



P

Caraffa termica, inox
Vacuum jug, stainless steel
Termokanne, 18-10 Edelstahl
Pot isothermique, inox
Jarra térmica, inox

art.	lt.
42401-10	1,0
42401-15	1,5
42401-20	2,0



P

Caraffa termica, inox
Vacuum jug, stainless steel
Termokanne, 18-10 Edelstahl
Pot isothermique, inox
Jarra térmica, inox

art.	lt.
42402-06	0,6
42402-10	1,0
42402-15	1,5
42402-20	2,0



Caffettiera pressa filtro, inox
French press, stainless steel
Kaffeebereiter, Edelstahl Rostfrei
Cafetière à piston, inox
Jarra para infusiones, inox

art.	ml.
41649-03	350
41649-06	600



Caraffa acrilico
Juice pitcher, acryl
Saftkanne, Acryl
Carafe à jus de fruits, acrilique
Jarra zumo, acrílico

art.	dim. cm.	h.	lt.
44995-25	23x13	27	2,5

Con tubo ghiaccio e camera frutta.
Contenuto con tubo 2,2 lt.
With ice-tube and fruit chamber,
content with tube 2,2 liters.



Caraffa, MS
Juice pitcher, MS
Saftkanne, MS
Carafe à jus de fruits, MS
Jarra zumo, MS

art.	ø cm.	h.	lt.
44992-03	26	29	3



P

Caraffa, MS
Juice pitcher, MS
Saftkanne, MS
Carafe à jus de fruits, MS
Jarra zumo, MS

art.	ø cm.	h.	lt.
44992-02	16,5	26	2

Antiurto e antigraffio, non idoneo al lavaggio in lavastoviglie, resistente fino a +85°C. - Shockproof, scratchproof, no dishwasher safe, heat resistant up to +85°C.



P

Caraffa, policarbonato
Water jug, PC
Wasserkrug, PC
Crûche à eau, PC
Jarra, PC

art.	ø cm.	h.	lt.
44999-09	10	15	0,9
44999-16	12	20	1,6



Caraffa, policarbonato
Juice pitcher, PC
Saftkanne, PC
Carafe à jus de fruits, PC
Jarra zumo, PC

art.	lt.
44871-30	1,0
44871-31	coperchio / lid

Impilabile. Coperchio in PP.
Stackable. PP lid.



Caraffa con coperchio, policarbonato
Juice pitcher with lid, PC
Saftkanne mit Deckel, PC
Carafe à jus de fruits avec couvercle, PC
Jarra zumo con tapa, PC

art.	lt.
44999-25	1,25



Caraffa vetro
Juice pitcher, glass
Glas-Saftkanne
Carafe à jus de fruits, verre
Jarra zumo, vidrio

art.	ø cm.	h.	lt.
44995-15	9,5	27	1,5

Coperchio inox. - Stainless steel lid.
-10°C/+110°C



Caraffa vetro
Juice pitcher, glass
Glas-Saftkanne
Carafe à jus de fruits, verre
Jarra zumo, vidrio

art.	ø cm.	h.	lt.
44995-14	16	27	1,4

Tappo apre e chiude automaticamente.
Piede cromato con eutettico, mantiene le bevande refrigerate fino a 4 ore.
Spout opens and closes automatically.
Chromed foot with cooler, keep drinks chilled up to 4 hours.



Caraffa vetro
Juice pitcher, glass
Glas-Saftkanne
Carafe à jus de fruits, verre
Jarra zumo, vidrio

art.	ø cm.	h.	lt.
44995-10	9,5	29	1

Tappo versatore apre e chiude automaticamente. - Spout opens and closes automatically while serving.

TAVOLA TABLE TOP



Piattino bustine thé, inox, set 2 pz
Tea bag rests, s/s, 2-pcs set
Teebeutel-Ablagen, Edelstahl, 2-er Set
Plat pour sachets de thé, inox, 2 pcs
Platito para bolsitas de té, inox, 2 pcs

art.	dim. cm.	h.
42619-02	12,5x7	1



P

Passathé, inox
Tea strainer, stainless steel
Teesieb, Edelstahl Rostfrei
Passoire à thé, inox
Colador bola infusiones, inox

art.	ø cm.
42617-04	4,5
42617-05	5,0
42617-06	6,5
42617-07	7,5



Passathé, inox
Tea strainer, stainless steel
Teesieb, Edelstahl Rostfrei
Passoire à thé, inox
Colador de té, inox

art.	ø cm.
41530-07	7,5



Passathé, inox
Tea strainer, stainless steel
Teesieb, Edelstahl Rostfrei
Passoire à thé, inox
Colador de té, inox

art.	ø cm.
41529-05	5



Passathé, inox
Tea strainer, stainless steel
Teesieb, Edelstahl Rostfrei
Passoire à thé, inox
Colador de té, inox

art.	ø cm.
41530-05	5



Passathé, inox
Tea strainer, stainless steel
Teesieb, Edelstahl Rostfrei
Passoire à thé, inox
Colador de té, inox

art.	ø cm.
41530-11	5



Portatoast, inox
Toast rack, stainless steel
Toastständer, Edelstahl Rostfrei
Support pour toast, inox
Porta tostadas, inox

art.	dim. cm.	h.	pz/pcs.
41599-08	20x11	5,7	8



Portauovo, inox
Egg cup, stainless steel
Eierbecher, Edelstahl Rostfrei
Coquetier, inox
Soporte huevos, inox

art.	ø cm.
41598-00	8,5



Portauovo, melamina, set 4 pz
Egg cup, melamine, set 4 pcs
Eierbecher, Melamin, 4er set
Coquetier, melamine, set 4 pcs
Soporte huevos, melamine, set 4 pz

art.	ø cm.	h.
41597-04	8,5	2



N

Vassoio
Tray
Platte
Plateau
Placa

art.	dim. cm.	mm[*]
41585-37	20x10	4-7
41585-38	30x10	4-7
41585-39	30x15	4-7



N

Set 2 vassoio
Tray, set 2 pieces
Platte, 2er Set
Plateaux, 2 pièces
Placas, 2 piezas

art.	ø cm.	l. handle	mm[*]
41585-60	23	8	4-7



N

Set 2 vassoio
Tray, set 2 pieces
Platte, 2er Set
Plateaux, 2 pièces
Placas, 2 piezas

art.	dim. cm.	l. handle	mm[*]
41585-61	26x20	8	4-7



Piano, GN 1/1
Tray, GN 1/1
Platte, GN 1/1
Plaque, GN 1/1
Placa, GN 1/1

art.	dim. cm.	mm[*]
41585-11	53x32,2	5-8

Piano, GN 1/2
Tray, GN 1/2
Platte, GN 1/2
Plaque, GN 1/2
Placa, GN 1/2

art.	dim. cm.	mm[*]
41585-12	32,5x26,5	4-7

Piano, GN 1/3
Tray, GN 1/3
Platte, GN 1/3
Plaque, GN 1/3
Placa, GN 1/3

art.	dim. cm.	mm[*]
41585-13	32,5x17,5	4-7



Piani in ardesia naturale. Eccellente immagazzinamento del freddo, idonei al contatto alimentare. Gli angoli dei piani sono spezzati (anzichè tagliati) per evidenziare la tipica struttura del materiale. Con piedini antiscivolo. Non idonei al lavaggio in lavastoviglie.

Natural slate trays. Natural slate trays. Excellent coldness retention, food safe. The edges of the trays are broken to show the typical structure of the natural material. With anti-slip feet. No dishwasher proof.

* Spessore ardesia. - *Material thickness.



Piano rettangolare
Tray, rectangular
Platte, rechteckig
Plaque, rectangulaire
Placa, rectangular

art.	dim. cm.	GN	mm(*)
41585-24	26,5x16,5	1/4	4-7
41585-23	53x16,2	2/4	4-7



Piano quadro
Tray, square
Platte, quadratisch
Plaque carré
Placa, cuadrada

art.	dim. cm.	mm(*)
41585-25	25x25	4-7
41585-30	30x30	4-7



Piano rettangolare
Tray, rectangular
Platte, rechteckig
Plaque, rectangulaire
Placa, rectangular

art.	dim. cm.	mm(*)
41585-45	45x30	4-7



Piano tondo
Tray, round
Platte, rund
Plaque, circulaire
Placa, redonda

art.	ø cm.	mm(*)
41586-22	22	4-7
41586-28	28	4-7
41586-33	33	4-7
41586-38	38	4-7



Set buffet 3 pz
Buffet set 3 pcs
Buffet-Set, 3-tlg.
Buffet set 3 pcs
Buffet set 3 pz

art.	ø cm.	mm(*)
41587-38	38	4-7



Piano quadro, set 4 pz
Tray, square, set 4 pcs
Platte, quadratisch, 4er set
Plaque carré, set 4 pcs
Placa, cuadrada, set 4 pz

art.	dim. cm.	mm(*)
41585-10	10x10	4-7

TAVOLA TABLE TOP



Vassoio con fori
Tray with holes
Platte mit Absätze
Plat avec trous
Placa con agujeros

art.	dim. cm.	ø hole	mm(*)	fori/holes
41585-01	25x12	3,5	4-7	1
41585-02	15x8	6,0	4-7	2
41585-03	28x10	3,5	4-7	3



Piatto con campana
Tray with dome
Platte mit Glashaube
Plat avec cloche
Bandeja y campana de cristal

Alzata 2 piani
2 tier tray
2-stufige Etagère
Présentoir 2 niveaux
Bandeja dos niveles

Supporto girevole
Revolving platter
Servierplatt, drehbar
Présentoir tournant
S oporte rotatorio

art.	ø cm.	h.	mm(*)
41585-00	10,5	8	4-7

art.	ø cm.	h.
41587-25	25-20	24

art.	ø cm.	h.
41587-32	32	2,5



41585-52 + 44843-24



41585-53 + 44843-12



41585-51 + 44842-30



Vassoio
Platter
Platte
Plat
Placa

41585-54 + 44842-35



art.	dim. cm.	mm(*)	per/fits
41585-51	24x15	5-8	44842-30
41585-52	47x10	5-8	44843-24
41585-53	26,5x20,5	5-8	44843-12
41585-54	32x12	4-7	44842-35



La forza del granito ed il calore del legno. Con piedini antiscivolo. - **Granite stone durability and the beauty of wood. With non-slip feet.**



Plancia, melamina
Tray, melamine
Tablett, Melamin
Plateau, melamine
Bandeja, melamine

Plancia, melamina
Tray, melamine
Tablett, Melamin
Plateau, melamine
Bandeja, melamine

art.	dim cm.	h.	GN	art.	dim cm.	h.	GN
44471-11	53x32,5	1,5	1/1	44472-11	53x32,5	1,5	1/1
44471-12	32,5x26,5	1,5	1/2	44472-12	32,5x26,5	1,5	1/2
44471-13	32,5x17,6	1,5	1/3	44472-13	32,5x17,6	1,5	1/3
44471-14	26,5x16,2	1,5	1/4	44472-14	26,5x16,2	1,5	1/4
44471-24	53x16,2	1,5	2/4	44472-24	53x16,2	1,5	2/4



Set 12 vasetti con coperchio
Set 12 glasses and cover
Gläser mit Deckel, 12er Set
Set 12 verres avec couvercle
12 vasos con tapa

art.	ø cm.	h.	ml.
41589-08	6	5,5	80
41589-14	6	7,0	140



Set 12 vasetti con coperchio
Set 12 glasses and cover
Gläser mit Deckel, 12er Set
Set 12 verres avec couvercle
12 vasos con tapa

art.	ø cm.	h.	ml.
41589-16	6	8	160



Set 12 vasetti con coperchio
Set 12 glasses and cover
Gläser mit Deckel, 12er Set
Set 12 verres avec couvercle
12 vasos con tapa

art.	ø cm.	h.	ml.
41589-22	7	8	220



Set 12 vasetti con coperchio
Set 12 glasses and cover
Gläser mit Deckel, 12er Set
Set 12 verres avec couvercle
12 vasos con tapa

art.	ø cm.	h.	ml.
41589-20	9	6	200



Set 2 vasetti con coperchio
Set 2 glasses and cover
Gläser mit Deckel, 2er Set
Set 2 verres avec couvercle
2 vasos con tapa

art.	ø cm.	h.	ml.
41589-58	11	11	580



Set 3 vasetti con coperchio
Set 3 glasses and cover
Gläser mit Deckel, 3er Set
Set 3 verres avec couvercle
3 vasos con tapa

art.	ø cm.	h.	ml.
41589-37	11	7,5	370



Set 6 bottigliette con coperchio
Set 6 bottles and cover
Flaschen mit Deckel, 6er Set
Set 6 bouteilles avec couvercle
6 botellas con tapa

art.	ø cm.	h.	ml.
41589-25	6,5	14,5	250



Set 6 bottigliette con coperchio
Set 6 bottles and cover
Flaschen mit Deckel, 6er Set
Set 6 bouteilles avec couvercle
6 botellas con tapa

art.	ø cm.	h.	ml.
41589-50	6,5	19	500



Set 6 bottigliette con coperchio
Set 6 bottles and cover
Flaschen mit Deckel, 6er Set
Set 6 bouteilles avec couvercle
6 botellas con tapa

art.	ø cm.	h.	lt.
41589-99	6,5	25,5	1,0



Set 10 guarnizioni
Set 10 rubber rings
Gummidichtringe, 10er Set
Set 10 joints
Juego 10 juntas

art.	ø cm.	per/matches
41589-AA	6	41589-08-14-16
N 41589-BB	9	41589-20
N 41589-CC	11	41589-37-58



N

Set 5 coperchi ermetici
Set 5 airtight covers
Frischhaltedeckel, 5er Set
Set 5 couvercles hermétiques
Juego 5 tapas herméticas

art.	ø cm.	per/matches
41589-AC	7	41589-08-14-16
		41589-25-50-99



Set 8 clip inox
Set 8 cover clamps, s/s
Deckel-Klammer 8er Set
Set 8 clips crochets inox
Juego 8 abrazaderas acero inox

art.
41589-AB



Supporto cromato
Serving stand, chrome plated
Serviergestell, hartverchromt
Présentoir, acier chromé
Soporte, acero cromado

art.	ø cm.	h.	per/matches
44840-28	22	33	41589-08



Supporto cromato
Serving stand, chrome plated
Serviergestell, hartverchromt
Présentoir, acier chromé
Soporte, acero cromado

art.	ø cm.	h.	per/matches
44840-27	22	59	41589-08-14-16



Set 12 vasetti (senza coperchi)
Set 12 glasses (without lid)
Gläser, 12er Set (ohne Deckel)
Set 12 verres (sans couvercle)
Juego 12 vasos (sin tapa)

art.	ø cm.	h.	ml.
41589C08	6	5,5	80
41589C16	6	8,0	160



N

Tagliere, melamina
Serving board, melamine
Servier-Brett, Melamin
Planche de service, mélamine
Tabla, melamina

art.	ø cm.	h.	l. handle
44470-70	30	1,5	12



N

Tagliere, melamina
Serving board, melamine
Servier-Brett, Melamin
Planche de service, mélamine
Tabla, melamina

art.	dim. cm.	h.	l. handle
44470-71	40x20	1,5	13



N

Tagliere, melamina
Serving board, melamine
Servier-Brett, Melamin
Planche de service, mélamine
Tabla, melamina

art.	dim. cm.	h.	l. handle
44470-72	48x20	1,5	13



Piani in melamina nera con una sofisticata e realistica finitura effetto ARDESIA che ne fanno una fantastica imitazione. Con piedini antiscivolo.
Black melamine trays with a sophisticated and realistic slate look, a real great imitation. With non-slip foot.



N



Plancia, melamina
Platter, melamine
Tablett, Melamin
Plateau, melamine
Bandeja, melamina

Tagliere, melamina
Serving board, melamine
Servier-Brett, Melamin
Planche de service, mélamine
Tabla, melamina

Ciotola, melamina
Bowl, melamine
Schüssel, Melamin
Bol, melamine
Bol, melamina

art.	dim. cm.	h.	GN
44470-11	53x32,5	1	1/1
44470-12	32,5x26,5	1	1/2
44470-13	32,5x17,5	1	1/3
44470-14	26,5x16,5	1	1/4
44470-24	53x16,2	1	2/4

art.	ø cm.	h.
44470-30	30	1
44470-40	40	1

art.	dim. cm.	h.	lt.
44470-03	19x19	9	1,5
44470-04	25x25	12	3,8



N



N



N

Tagliere, melamina
Serving board, melamine
Servier-Brett, Melamin
Planche de service, mélamine
Tabla, melamina

Cloche, SAN
Cover
Haube
Couvercle
Tapa

Cloche, SAN
Cover
Haube
Couvercle
Tapa

art.	ø cm.	h.	l. handle
44470-60	18,5	1,5	8,5
44470-61	23,0	1,5	10,0
44470-62	33,5	1,5	14,0
44470-63	37,5	1,5	15,5

art.	ø cm.	h.	per/for
44475-85	16,5	10	44470-60
44475-86	20,5	10	44470-61

art.	ø cm.	h.	per/for
44475-87	30	11,5	44470-62
41537-33	33	12,5	44470-63

Plancia, melamina
Tray, melamine
Tablett, Melamin
Plateau, melamine
Bandeja, melamina

N

art.	dim. cm.	h.
44470-73	20x10	2
44470-74	30x10	2
44470-75	30x15	2





Vassoio, melamina
Tray, melamine
Tablett, Melamin
Plateau, melamine
Bandeja, melamina

art.	ø cm.	h.
44475-89	35	3
44475-90	44	3

Vassoio, melamina
Tray, melamine
Tablett, Melamin
Plateau, melamine
Bandeja, melamina

art.	dim. cm.	h.
44475-91	44x25	1,5

Vassoio, melamina
Tray, melamine
Tablett, Melamin
Plateau, melamine
Bandeja, melamina

art.	dim. cm.	h.
44475-92	65x26	3,0

Vassoio, melamina
Tray, melamine
Tablett, Melamin
Plateau, melamine
Bandeja, melamina

art.	dim. cm.	h.
44475-93	70x26	3



Vassoio, melamina
Tray, melamine
Tablett, Melamin
Plateau, melamine
Bandeja, melamina

art.	ø cm.	h.
44475-94	35	3
44475-95	44	3

Vassoio, melamina
Tray, melamine
Tablett, Melamin
Plateau, melamine
Bandeja, melamina

art.	dim. cm.	h.
44475-96	44x25	1,5

Vassoio, melamina
Tray, melamine
Tablett, Melamin
Plateau, melamine
Bandeja, melamina

art.	dim. cm.	h.
44475-97	65x26	3,0

Vassoio, melamina
Tray, melamine
Tablett, Melamin
Plateau, melamine
Bandeja, melamina

art.	dim. cm.	h.
44475-98	70x26	3



Taglieri in melamina effetto legno di quercia e piani a servire in melamina finitura legno di quercia sbiancato.
Melamine serving boards oak wood effect and serving trays light oak look.



Plancia, melamina
Serving board, melamine
Tablett, Melamin
Plateau, melamine
Bandeja, melamina

art.	ø cm.	h.	l. handle
44474-30	30	1,5	12



Plancia, melamina
Serving board, melamine
Tablett, Melamin
Plateau, melamine
Bandeja, melamina

art.	dim. cm.	h.	l. handle
44474-40	40x20	1,5	13



Plancia, melamina
Serving board, melamine
Tablett, Melamin
Plateau, melamine
Bandeja, melamina

art.	dim. cm.	h.	l. handle
44474-48	48x20	1,5	13

Plancia, melamina
Tray, melamine
Tablett, Melamin
Plateau, melamine
Bandeja, melamina

art.	dim. cm.	h.	GN
44473-11	53x32,5	1,5	1/1
44473-12	32,5x26,5	1,5	1/2
44473-13	32,5x17,6	1,5	1/3
44473-14	26,5x16,2	1,5	1/4
44473-24	53x16,2	1,5	2/4





Ogni pezzo è realizzato a mano quindi dimensioni, forma e finitura variano da pezzo a pezzo. Lavare a mano con acqua tiepida e sapone. Non mettere in ammollo. - Each piece is carefully crafted by hand therefore size, shape and finish may vary from piece to piece. Wash by hand with warm soapy water, do not to soak.



Tagliere, legno di ulivo
Serving board, olive wood
Servier-Brett Olive
Planche de service en bois d'olivier
Tabla en madera de olivo

Tagliere, legno di ulivo
Serving board, olive wood
Servier-Brett Olive
Planche de service en bois d'olivier
Tabla en madera de olivo

Tagliere, legno di ulivo
Serving board, olive wood
Servier-Brett Olive
Planche de service en bois d'olivier
Tabla en madera de olivo

art.	dim. cm.	h.
41320-25	25x17	1,5
41320-30	30x20,5	2,0
41320-35	35x24	2,0

art.	dim. cm.	h.	l. handle
41321-40	40x15	1,5	11
41321-44	44x20	2,0	12

art.	dim. cm.	h.	l. handle
41322-19	19x12,2	1,5	6
41322-25	25x16	1,5	8
41322-31	31x20	1,5	9



Tagliere, betulla
Serving board, birch
Servier-Brett, Birke
Planche de service, bouleua
Tabla en abedul

Tagliere, betulla
Serving board, birch
Servier-Brett, Birke
Planche de service, bouleua
Tabla en abedul

Tagliere, betulla
Serving board, birch
Servier-Brett, Birke
Planche de service, bouleua
Tabla en abedul

art.	dim. cm.	h.
41325-20	20x12	3

art.	dim. cm.	h.
41325-30	30x20	3

art.	dim. cm.	h.
41325-40	40x15	3



Tagliere, acacia/ardesia
Serving board, acacia/slate
Servier-Brett, Akazie/Schiefer
Planche de service, acacia/ardoise
Tabla en acacia/pizarra

Tagliere, acacia/ardesia
Serving board, acacia/slate
Servier-Brett, Akazie/Schiefer
Planche de service, acacia/ardoise
Tabla en acacia/pizarra

Tagliere, acacia/ardesia
Serving board, acacia/slate
Servier-Brett, Akazie/Schiefer
Planche de service, acacia/ardoise
Tabla en acacia/pizarra

art.	dim. cm.	h.
41326-30	30,5x13	1,5

art.	dim. cm.	h.
41326-36	36,5x15	1,5

art.	dim. cm.	h.
41326-42	42x18	1,5



41323-AA
Piedini antiscivolo in opzione.
Non-slip foot available on request.

Plance in poliestere rinforzato, idoneo al contatto alimentare, lavabile in lavastoviglie. Finitura ruvida naturale ed elegante al tempo stesso. Possono essere utilizzate come piatto presentazione e come vassoi espositivi. Disponibili in 3 colorazioni. - **In reinforced polyester, suitable for food contact, dishwasher safe. Natural rough finish and elegant at the same time. They can be used as showplate and as presentation tray as well. Available in 3 colors.**



Plancia rettangolare LIGHT
Platter, rectangular
Serviertablett, rechteckig
Plateau rectangulaire
Bandeja rectangular

art.	dim. cm.	h.
41323-11	30x20	0,5
41323-12	40x20	0,5
41323-13	40x30	0,5
41323-14	60x40	0,5



Plancia rettangolare VINTAGE
Platter, rectangular
Serviertablett, rechteckig
Plateau rectangulaire
Bandeja rectangular

art.	dim. cm.	h.
41323-21	30x20	0,5
41323-22	40x20	0,5
41323-23	40x30	0,5
41323-24	60x40	0,5



Plancia rettangolare ARDESIA
Platter, rectangular
Serviertablett, rechteckig
Plateau rectangulaire
Bandeja rectangular

art.	dim. cm.	h.
41323-01	30x20	0,5
41323-02	40x20	0,5
41323-03	40x30	0,5
41323-04	60x40	0,5



N

Plancia rotonda LIGHT
Platter, round
Serviertablett, rund
Plateau ronde
Bandeja redonda

art.	ø cm.	h.
41323-16	30	0,5
41323-17	38	0,5
41323-18	40	0,5



N

Plancia rotonda VINTAGE
Platter, round
Serviertablett, rund
Plateau ronde
Bandeja redonda

art.	ø cm.	h.
41323-26	30	0,5
41323-27	38	0,5
41323-28	40	0,5



N

Plancia rotonda ARDESIA
Platter, round
Serviertablett, rund
Plateau ronde
Bandeja redonda

art.	ø cm.	h.
41323-06	30	0,5
41323-07	38	0,5
41323-08	40	0,5



Nero con bordi marrone. - **Black with brown edges.**



Ciotola, melamina
Bowl, melamine
Schüssel, Melamin
Bol, melamine
Bol, melamina

art.	dim. cm.	h.	lt.
44480-00	25,5x14	5,5	0,4
44480-01	36x19	8,0	0,9



Vassoio, melamina
Tray, melamine
Tablett, Melamin
Plateau, melamine
Bandeja, melamina

art.	dim. cm.	h.
44480-03	14,5x14,5	2



Vassoio, melamina
Tray, melamine
Tablett, Melamin
Plateau, melamine
Bandeja, melamina

art.	dim. cm.	h.
44480-04	22,5x15	3
44480-05	27,5x11	2



Vassoio, melamina
Tray, melamine
Tablett, Melamin
Plateau, melamine
Bandeja, melamina

art.	dim. cm.	h.
44480-06	26,5x16,5	4



Vassoio, melamina
Tray, melamine
Tablett, Melamin
Plateau, melamine
Bandeja, melamina

art.	dim. cm.	h.
44480-17	19,5x9,5	2
44480-18	39x16	3



Vassoio, melamina
Tray, melamine
Tablett, Melamin
Plateau, melamine
Bandeja, melamina

art.	dim. cm.	h.
44480-19	32,5x23,5	4,5



Ciotola, melamina
Bowl, melamine
Schüssel, Melamin
Bol, melamine
Bol, melamina

art.	ø cm.	h.	lt.
44480-20	30,5	8,5	2



Ciotola, melamina
Bowl, melamine
Schüssel, Melamin
Bol, melamine
Bol, melamina

art.	ø cm.	h.	lt.
44480-10	14	6,0	0,3
44480-11	19	8,0	0,8
44480-12	21	8,5	1,0
44480-13	24	9,5	1,4



Ciotola, melamina
Bowl, melamine
Schüssel, Melamin
Bol, melamine
Bol, melamina

art.	dim. cm.	h.	lt.
44480-14	23,5x23,5	6,5	0,7



Ciotola, melamina
Bowl, melamine
Schüssel, Melamin
Bol, melamine
Bol, melamina

art.	ø cm.	h.	lt.
44480-15	11	3,5	0,13
44480-16	14	4,0	0,20



Ciotola, melamina
Bowl, melamine
Schüssel, Melamin
Bol, melamine
Bol, melamina

art.	ø cm.	h.	lt.
44480-09	11	5,5	0,2



Ciotola, melamina
Bowl, melamine
Schüssel, Melamin
Bol, melamine
Bol, melamina

art.	ø cm.	h.	lt.
44480-07	8,5	2,5	0,05



Ciotola, melamina
Bowl, melamine
Schüssel, Melamin
Bol, melamine
Bol, melamina

art.	ø cm.	h.	lt.
44480-08	11,5	3	0,04



N



Ciotole e vassoi in un elegante colore nero opaco con macchie lucide, ideali sia per la tavola che per il buffet.
Bowls and trays in elegant matte black color with glossy spots, an eye-catcher for table and buffet.



Ciotola, melamina
Bowl, melamine
Schüssel, Melamin
Bol, melamine
Bol, melamina

art.	ø cm.	h.	lt.
44478-40	8	3	0,05
44478-41	12	5	0,35
44478-42	15	8	0,70



Ciotola, melamina
Bowl, melamine
Schüssel, Melamin
Bol, melamine
Bol, melamina

art.	dim. cm.	h.	lt.
44478-43	19,5x9	5,0	0,2



Ciotola, melamina
Bowl, melamine
Schüssel, Melamin
Bol, melamine
Bol, melamina

art.	dim. cm.	h.	lt.
44478-44	21,5x14,5	4,5	0,3



Vassoio, melamina
Tray, melamine
Tablett, Melamin
Plateau, melamine
Bandeja, melamina

art.	dim. cm.	h.
44478-45	26,5x8,5	2
44478-46	33,5x11	3



Vassoio, melamina
Tray, melamine
Tablett, Melamin
Plateau, melamine
Bandeja, melamina

art.	dim. cm.	h.
44478-47	27x12	3,0



Vassoio, melamina
Tray, melamine
Tablett, Melamin
Plateau, melamine
Bandeja, melamina

art.	dim. cm.	h.
44478-48	37x11	2,5



Vassoio, melamina
Tray, melamine
Tablett, Melamin
Plateau, melamine
Bandeja, melamina

art.	dim. cm.	h.
44478-49	30x11	3



Vassoio, melamina
Tray, melamine
Tablett, Melamin
Plateau, melamine
Bandeja, melamina

art.	dim. cm.	h.
44478-50	25x15,5	1,5
44478-51	30,5x19	1,5

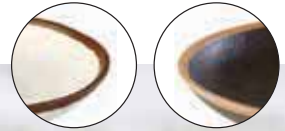

N



Per servire o per il buffet, una perfetta imitazione di argilla, con bordo marrone. Superficie interna ed esterna finemente opaca e con effetto argilla al tatto.
Serving and buffet items, an imitation of clay, with a brown border. The surface is inside and outside fine-matt. Feels like real clay.



Piatto piano, melamina
Flat plate, melamine
Teller flach, Melamin
Assiette plate, melamine
Plato llano, melamina

Piatto piano, melamina
Flat plate, melamine
Teller flach, Melamin
Assiette plate, melamine
Plato llano, melamina

Piatto fondo, melamina
Soup plate, melamine
Teller tief, Melamin
Assiette creuse
Plato hondo, melamina

Piatto fondo, melamina
Soup plate, melamine
Teller tief, Melamin
Assiette creuse
Plato hondo, melamina

art.	dim. cm.	h.
44478-22	14x13	2,5

art.	dim. cm.	h.
44478-23	14x13	2,5

art.	ø cm.	h.	lt.
44478-20	20,5	3	0,5

art.	ø cm.	h.	lt.
44478-21	20,5	3	0,5



Ciotola, melamina
Bowl, melamine
Schüssel, Melamin
Bol, melamine
Bol, melamina

Ciotola, melamina
Bowl, melamine
Schüssel, Melamin
Bol, melamine
Bol, melamina

Ciotola, melamina
Bowl, melamine
Schüssel, Melamin
Bol, melamine
Bol, melamina

Ciotola, melamina
Bowl, melamine
Schüssel, Melamin
Bol, melamine
Bol, melamina

art.	ø cm.	h.	lt.
44478-24	12,5	6	0,37
44478-26	16,0	7	0,70
44478-28	16,5	4	0,50
44478-30	21,0	8	1,45

art.	ø cm.	h.	lt.
44478-25	12,5	6	0,37
44478-27	16,0	7	0,70
44478-29	16,5	4	0,50
44478-31	21,0	8	1,45

art.	dim. cm.	h.	lt.
44478-32	30,5x10	7,5	0,17
44478-34	42x14	9,5	0,65

art.	dim. cm.	h.	lt.
44478-33	30,5x10	7,5	0,17
44478-35	42x14	9,5	0,65



Mix di colori e texture - i piatti con rilievo a onda si ispirano alla natura. Il design della parte inferiore permette di posizionarli saldamente su supporti e ciotole.
Mix of colours and textures – the platters feature a wave relief inspired by natural forms. The underside design allows them to be positioned firmly on stands and bowls.



Plancia, melamina
Tray, melamine
Tablett, Melamin
Plateau, melamine
Bandeja, melamina

art.	dim. cm.	h.	GN
44476-01	26,5x16,2	1,5	1/4
44476-02	32,5x17,6	1,5	1/3
44476-03	32,5x26,5	1,5	1/2
44476-04	53x16,2	1,5	2/4



Plancia, melamina
Tray, melamine
Tablett, Melamin
Plateau, melamine
Bandeja, melamina

art.	dim. cm.	h.	GN
44476-05	26,5x16,2	1,5	1/4
44476-06	32,5x17,6	1,5	1/3
44476-07	32,5x26,5	1,5	1/2
44476-08	53x16,2	1,5	2/4



Plancia, melamina
Tray, melamine
Tablett, Melamin
Plateau, melamine
Bandeja, melamina

art.	dim. cm.	h.	GN
44476-09	26,5x16,2	1,5	1/4
44476-10	32,5x17,6	1,5	1/3
44476-11	32,5x26,5	1,5	1/2
44476-12	53x16,2	1,5	2/4



Plancia, melamina
Tray, melamine
Tablett, Melamin
Plateau, melamine
Bandeja, melamina

art.	dim. cm.	h.	GN
44476-13	26,5x16,2	1,5	1/4
44476-14	32,5x17,6	1,5	1/3
44476-15	32,5x26,5	1,5	1/2
44476-16	53x16,2	1,5	2/4



Vassoio, melamina
Tray, melamine
Tablett, Melamin
Plateau, melamine
Bandeja, melamina

art.	dim. cm.	h.	GN
44476-17	53x32,5	2	1/1



Vassoio, melamina
Tray, melamine
Tablett, Melamin
Plateau, melamine
Bandeja, melamina

art.	dim. cm.	h.	GN
44476-18	53x32,5	2	1/1





Vassoio con ciotole melamina
Tray with melamine bowls
Tablett mit Melamin-Schalen
Plateau avec coupes melamine
Bandeja con copas melamina

art. dim. cm.
44838-05 20x20



Vassoio con ciotole melamina
Tray with melamine bowls
Tablett mit Melamin-Schalen
Plateau avec coupes melamine
Bandeja con copas melamina

art. dim. cm.
44838-07 29x20



Vassoio con ciotole melamina
Tray with melamine bowls
Tablett mit Melamin-Schalen
Plateau avec coupes melamine
Bandeja con copas melamina

art. dim. cm.
44838-03 20x11

Ciotole melamina bianco art. 44847-09 cm. 9x9. - Melamina bowl white item 44847-09 cm. 9x9



Vassoio Gourmet, melamina
Tray Gourmet, melamine
Tablett GOURMET, Melamin
Plateau, melamine
Bandeja, melamine

art. dim. cm. h. ø holes
44466-30 30,5x9,5 2,5 4



Ciotoline Gourmet, melamina
Bowl gourmet, melamine
Schälchen GOURMET, Melamin
Bol, melamine
Bols, melamine

art. ø cm. h. ml.
44466-07 7 6 50



Senapiera, inox
Mustard cup, stainless steel
Senfschale, Edelstahl Rostfrei
Moutardier, inox
Mostacero, inox

art. ø cm.
41564-07 7



Coppa burro, inox
Butter cup, stainless steel
Butterservierer, Edelstahl Rostfrei
Coupe à beurre, inox
Copa mantequilla, inox

art. ø cm.
41563-07 7



Coppa burro, inox
Butter cup, stainless steel
Butterservierer, Edelstahl Rostfrei
Coupe à beurre, inox
Copa mantequilla, inox

art. ø cm.
41561-09 9



Salsiera termica, acciaio inox
Insulated sauce boat, stainless steel
Thermo-Sauciere, doppelwandig, Edelstahl
Saucière isotherme, inox
Salsera termica, inox

art. dim. cm. h. lt.
41620-04 19x12,5 13 0,4



Salsiera, inox
Gravy boat with foot, stainless steel
Saucière mit Fuss, Edelstahl Rostfrei
Saucière sur pied, inox
Salsera con pie, inox

art. lt.
41615-01 0,15
41615-03 0,25
41615-05 0,45



Zuppiera testa di leone
Soup bowl
Suppentasse Löwenkopf
Soupière tête de lion
Sopera cabeza de león

art. ø cm. cl.
44379-05 11 50



Piatto ovale a barchetta
Oval dish
Platte, oval
Plat oval
Plato oval

art.	dim. cm.
44368-24	24x15,5
44368-30	30x22
44368-35	35x26
44368-40	40x28,5
44368-45	45x32



Ciotola per insalata
Salad bowl
Salatschüssel
Saladier
Bol para ensalada

art.	ø cm.	h.
44369-19	19,0	7,5
44369-21	21,0	8,0



Insalatiera esagonale
Hexagonal salad bowls
Salatschüssel, sechseckig
Saladier, hexagonal
Bol ensalada, hexagonal

art.	ø cm.	h.
44399-21	21	6,5
44399-23	23	9,5
44399-27	27	12,0



Insalatiera triangolare
Triangular salad bowl
Salatschüssel, dreieckig
Saladier, triangulaire
Bol ensalada, triangular

art.	ø cm.	h.
44370-20	20	10



Insalatiera, policarbonato
Salad bowl, PC
Salatschüssel, PC
Saladier, PC
Bol para ensalada, PC

art.	ø cm.	h.	lt.
44950-15	15,2	5,0	0,6
44950-20	20,3	6,5	1,7
44950-25	25,4	8,0	3,0
44950-30	30,5	10,0	5,5
44950-38	38,1	12,5	10,6



Insalatiera quadra, policarbonato
Square salad bowl, PC
Salatschüssel, quadratisch, PC
Saladier carré, PC
Bol para ensalada cuadrada, PC

art.	dim. cm.	h.
44357-10	24x24	10
44357-15	24x24	15



Ciotola tonda
Round bowl
Schüssel, rund
Bassine ronde
Bol redonda

art.	ø cm.
42932-15	15,0
42932-30	30,5



Ciotola ovale
Oval bowl
Schüssel, oval
Bassine ovale
Bol oval

art.	dim. cm.
42931-19	19,5x17



Insalatiera quadra, policarbonato
Square salad bowl, PC
Salatschüssel, quadratisch, PC
Saladier carré, PC
Bol para ensalada cuadrada, PC

art.	dim. cm.	h.
44357B10	24x24	10
44357B15	24x24	15

Non idoneo al lavaggio in lavastoviglie. - No dishwasher safe.



Cesto pane, ovale, inox 18-10
Oval bread basket, 18-10 stainless steel
Brotschale, oval, 18-10 Edelstahl
Panier à pain, ovale, inox 18-10
Cesta pan, oval, acero 18-10

art.	dim. cm.	h.
66392-18	18x12	5
66392-22	22x16	5



Cesto pane, inox
Bread basket, stainless steel
Brotkorb, Edelstahl Rostfrei
Panier, inox
Cesta pan, inox

art.	ø cm.
41629-17	17,0
41629-20	20,0
41629-25	25,5



Cesto pane ovale, inox
Oval bread basket, stainless steel
Brotkorb, oval, Edelstahl Rostfrei
Panier ovale, inox
Cesta pan oval, inox

art.	dim. cm.
42956-19	19x15
42956-24	24,5x18
42956-28	28x21



PR

CESTI POLYRATTAN
Polyrattan baskets
PAGINA - Page: 177



Portagrissini, inox
Breadstick basket, stainless steel
Salzstangenkorb, Edelstahl Rostfrei
Panier à gressins, inox
Porta grissini, inox

art.	ø cm.	h.
41624-00	9,5	13,5



Tagliatartufi, inox
Truffle-slicer, stainless steel
Trüffelschneider, Edelstahl Rostfrei
Coupe-truffes, inox
Corta trufa, inox

art.	dim. cm.	lama/blade
48237-00	21x8,5	liscia/plain
48237-01	21x8,5	ondulata/serrated



Tagliatartufi, inox
Truffle-slicer, stainless steel
Trüffelschneider, Edelstahl Rostfrei
Coupe-truffes, inox
Corta trufa, inox

art.	dim. cm.	lama/blade
48236-00	21x8,5	liscia/plain
48236-01	21x8,5	ondulata/serrated

Manico in palissandro. - Rosewood handle.

N



Confezione Tuberpack, PC
Truffle jar
Trüffel-Verpackung
Récipient à truffes
Envasado para trufa

art.	ø cm.	h.
48237-99	6	4,5

Ideale per trasporto e conservazione, previene il calo di peso. - For transport and storage, prevents weight loss.

N



Servitartufi
Truffle server
Trüffel-Service
Service à truffes
Servidor de trufas

art.	dim. cm.	h.
48237-35	30x20x1,5	9

Castagno. - Chestnut wood.



Portaposate, GN 1/1
Cutlery dispenser, GN 1/1
Besteckkorb, GN 1/1
Panier à couverts, GN 1/1
Cesta portacubiertos GN 1/1

art.	dim. cm.	h.
42584-04	53x32,5	10

PR



Portaposate
Cutlery dispenser
Besteck-Ablage
Panier à couverts
Cesta portacubiertos

art.	dim. cm.	h.
42584-02	27x10	4,5

PR



Portaposate/grissini
Cutlery/breadstick basket
Besteck-/Salzstangenkorb
Panier à couverts/gressins
Cesta cubiertos/grissini

art.	ø cm.	h.
42584-01	12	15

PR



Portaposate
Cutlery dispenser
Besteckbehälter
Bac à couverts
Dispensador de cubiertos

art.	dim. cm.	h.
42584-05	53x32,5	9

PR



P



P

Portaposate
Cutlery dispenser
Besteck-Korb
Panier à couverts
Cesta portacubiertos

PR

Spargisale/pepe cromato
Salt/pepper shaker, chrome top
Salz-/Pfefferstreuer, verchromt
Salière/poivrier, chromé
Salero/pimentero, cromado

Set sale e pepe, inox
Condiment set, stainless steel
Menage, 2-teilig, Edelstahl Rostfrei
Ménagère, inox
Servicio de mesa, 2 piezas, inox

art.	ø cm.	h.	col.
42584-06	26x18	15	●
42584-07	26x18	15	●

art.	ml.
42928-00	45

art.	dim. cm.	h.
42927-02	3x3	5



Set spargisale/pepe, inox
Salt/pepper shaker set, stainless steel
Salz- und Pfefferstreuer-Set, Edelstahl Rostfrei
Set salière et poivrier, inox
Juego 2 piezas sal y pimienta, inox

Set 4 pz spargisale/pepe, inox
Small shaker, 4 pcs set, stainless steel
Ministreuer, Edelstahl Rostfrei
Set 4 pièces salière et poivrier, inox
Juego de 4 piezas bodegas pequeñas, inox

Set 12 pz spargisale/pepe a 3 fori, inox
Salt/pepper shaker, 12 pcs set, s/s
Allzweckstreuer, 12er Set, Edelstahl
Set 12 pièces salière et poivrier, inox
Juego 12 piezas dosificador, inox

art.	ø cm.	h.
42924-02	5	6,5

art.	ø cm.	h.
42925-04	3,5	4

art.	ø cm.	h.
42926-12	3	9



N



N



N

Set sale e pepe
Condiment set, 2-pcs
Menage, 2-teilig
Ménagère, 2 pièces
Servicio de mesa, 2 piezas

Servizio oliera, 2 pezzi
Condiment set, 2 pcs
Menage, 2-teilig
Ménagère, 2 pièces
Servicio de mesa, 2 piezas

Servizio oliera, 4 pezzi
Condiment set, 4 pcs,
Menage, 4-teilig
Ménagère, 4 pièces
Servicio de mesa, 4 piezas

art.	dim. cm.	h.
42929-01	11,5x5,5	17

art.	dim. cm.	h.
42929-02	16x7,5	24,5

art.	dim. cm.	h.
42929-03	15,5x12	24,5

Base legno, manico inox satinato. - Wood base with satin polished handle.



P



Nebulizzatore olio/acetato, inox
Oil/vinegar sprayer, stainless steel
Oel/Essig-Spray, Edelstahl Rostfrei
Atomiseur à huile/vinaigre, inox
Aerosol para aceite/vinagre, inox

Porta olio/acetato, inox
Oil and vinegar stand, stainless steel
Essig u. Öl-Stand, Edelstahl Rostfrei
Porte huile et vinaigre, inox
Soporte para aceite y vinagre, inox

Porta olio/acetato, inox
Oil and vinegar stand, stainless steel
Essig u. Öl-Stand, Edelstahl Rostfrei
Porte huile et vinaigre, inox
Soporte para aceite y vinagre, inox

art.	h. cm.	ml.	
41635-00	19	150	oil
41635-01	19	150	vinegar

art.	dim. cm.	h.
66362-02	12,5x6	27

art.	dim. cm.	h.	ml.
41636-25	13x7	30	250
41636-50	14,5x8,5	35	500

TAVOLA TABLE TOP



Servizio oliera, 4 pezzi, inox 18/8
Condiment set, 4 pcs, stainless steel
Menage, 4-teilig, Edelstahl Rostfrei
Ménagère, 4 pièces, inox
Servicio de mesa, 4 piezas, inox

art.	dim. cm.	h.
41638-04	17,5x10,5	23

Con tappo versatore antigoccia in polietilene. - With non drip - PE nozzle spout.



Servizio oliera, 2 pezzi, inox 18/8
Condiment set, 2 pcs, stainless steel
Menage, 2-teilig, Edelstahl Rostfrei
Ménagère, 2 pièces, inox
Servicio de mesa, 2 piezas, inox

art.	dim. cm.	h.
41638-02	14,5x8,5	23



Set sale, pepe, stecchi, inox 18/8
Condiment set, 3-pcs stainless steel
Menage, 3-teilig, Edelstahl Rostfrei
Ménagère, 3 pièces, inox
Servicio de mesa, 3 piezas, inox

art.	ø cm.	h.
41638-13	10,5	16



Set sale e pepe, inox 18/8
Condiment set, 2-pcs stainless steel
Menage, 2-teilig, Edelstahl Rostfrei
Ménagère, 2 pièces, inox
Servicio de mesa, 2 piezas, inox

art.	dim. cm.	h.
41638-12	10,5x6,5	16



Formaggiera, inox 18/8
Cheese jar, stainless steel
Käsedose, Edelstahl Rostfrei
Fromagère, inox
Quesera, inox

art.	ø cm.	h.
41638-01	10,5	7



Spargiformaggio, inox
Cheese shaker, stainless steel
Käsestreuer, Edelstahl Rostfrei
Poudreuse à fromage, inox
Quesera, inox

art.	cl.
42921-00	36



N

Portacondimenti, legno
Table caddy, wood
Tisch-Caddy, Holz
Caddy de table, bois
Caddy de mesa, madera

art.	ø cm.	h.
41639-17	17,5	8,5



N

Portacondimenti 4 comparti, legno
Table caddy 4 compartments, wood
Tisch-Caddy 4-Fächer, Holz
Caddy de table 4 compartiments, bois
Caddy de mesa 4 compartimentos, madera

art.	dim. cm.	h.	col.
41639-30	17x17	10	bianco/white
41639-31	17x17	10	turchese/blue
41639-32	17x17	10	giallo/yellow

Scomparti/compartments cm 7x7.



N

Portacondimenti 6 comparti, legno
Table caddy 6 compartments, wood
Tisch-Caddy 6-Fächer, Holz
Caddy de table 6 compartiments, bois
Caddy de mesa 6 compartimentos, madera

art.	dim. cm.	h.	col.
41639-40	27x17	10	bianco/white
41639-41	27x17	10	turchese/blue
41639-42	27x17	10	giallo/yellow

Scomparti/compartments cm 7,5x7,5.



N

Portaposate, legno
Cutlery dispenser, wood
Besteck-Ablage, Holz
Panier à couverts, bois
Cesta portacubiertos, madera

art.	ø cm.	h.
41639-11	11,5	14,0



Fermatovaglia, set 4 pz
Table-cloth clips, 4 pcs set
Tischtuch Klammer, 4-Tlg
Pincas à nappe, 4 pièces
Pinzas para mantel, 4 piezas

art.	per tavoli/for table h.
42953-04	per tavoli/for table h. 3 cm.



Legatovagliolo, inox
Napkin holder, stainless steel
Serviettenring, Edelstahl Rostfrei
Porteserviette, inox
Servilletero, inox

art.
42955-00

TOVAGLIETTE - TABLE MATS

PLATZMATTE - SET DE TABLE - MANTELES INDIVIDUALES



Melange chiaro
 Light melange

art.	dim. cm.	u.pack
42950-01	42x33	6



Beige

art.	dim. cm.	u.pack
42950-02	42x33	6

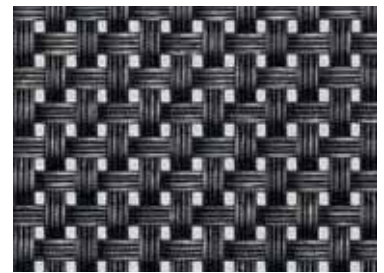

Nero
 Black

art.	dim. cm.	u.pack
42950-03	42x33	6



Marrone
 Brown

art.	dim. cm.	u.pack
42950-04	42x33	6



Beige / Grigio
 Beige / Grey

art.	dim. cm.	u.pack
42950-05	42x33	6

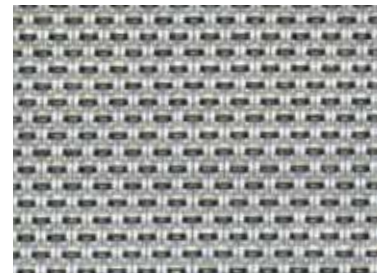

Grigio
 Grey

art.	dim. cm.	u.pack
42950-06	42x33	6



Crispy

art.	dim. cm.	u.pack
42950-07	42x33	6



Corallo
 Coral

art.	dim. cm.	u.pack
42950-08	42x33	6

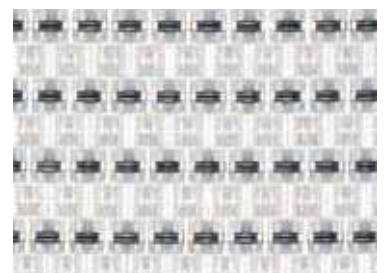

Gessato bianco
 White pin-striped

art.	dim. cm.	u.pack
42950-09	42x33	6

RUNNER - RUNNERS



Materiale: 50% Poliestere - 50% Cloruro di polivinile

Material: 50% polyester - 50% Polyvinyl chloride



Beige

art. dim. cm.
42950-92 42x180

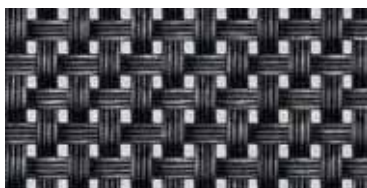

Nero
Black

art. dim. cm.
42950-93 42x180



Marrone
Brown

art. dim. cm.
42950-94 42x180



N

Rechaud, inox
Plate warmer, stainless steel
Speisenwärmer, Edelstahl Rostfrei
Réchaud, inox
Calentador de platos, inox

art. ø cm. h. g/hr KW
41316-25 25 9,5 158 2,2



N

Rechaud, inox
Plate warmer, stainless steel
Speisenwärmer, Edelstahl Rostfrei
Réchaud, inox
Calentador de platos, inox

art. ø cm. h. g/hr KW
41317-20 20 11 90 1,4



N

Rechaud, inox/rame
Plate warmer, stainless steel/copper
Speisenwärmer, Edelstahl/Kupfer
Réchaud, inox/cuivre
Calentador de platos, inox/cobre

art. ø cm. h. g/hr KW
41317C20 20 11 90 1,4

Tempo di combustione 2 ore a fiamma media. - Burning time 2 hours with an average flame.



Set fonduta, rame
Fondue set, copper
Fondue-Service, Kupfer
Service à fondue, cuivre
Servicio para fondues, cobre

art. ø cm. h.
15430-11 16 26



P

Set fonduta formaggio
Cheese fondue set
Käsefondue-Service
Service à fondue fromage
Servicio para fondues queso

art. ø cm. h.
41311-00 22 17,5



P

Set fonduta bourguignonne
Bourguignonn fondue set
Bourguignonnefondue-Service
Service à fondue bourguignonne
Servicio para fondues bourguignonne

art. ø cm. h.
41312-00 20 18

**TAVOLA TABLE TOP
COMPLEMENTI SERVING ITEMS**



Fonduta cioccolato
Chocolate fondue
Schokoladefondue
Fondue à chocolat
Fondue chocolate

art.	ø cm.	h.
42415-09	13	12



N

Piatto 5 scomparti
Dish 5 Sections
Teller 5-Geteilt
Plat 5 Compartiments
Plato 5 Secciones

art.	ø cm.	h.
42415-26	26,5	3,5



Set forchette, 6 pz
Dipping forks, 6 pcs
6 Stk. Fonduegabelche
6 curettes à fondue
6 tenedores para fondue

art.	l. cm.
15428-06	24



P

Supporto con pietra ollare
Stand with grill stone
Träger mit Kochstein
Pierre à cuire avec support
Soporte con piedra

art.	dim. cm.	h.
41315-02	17x20	12



P

Supporto con pietra ollare
Stand with grill stone
Träger mit Kochstein
Pierre à cuire avec support
Soporte con piedra

art.	dim. cm.	h.
41315-04	44x20	12

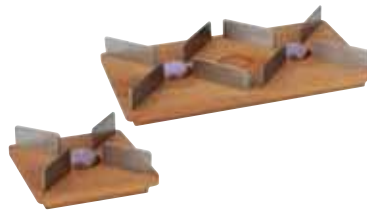

Rechaud, inox
Plate warmer, stainless steel
Speisenwärmer, Edelstahl Rostfrei
Chauffe-plats, inox
Calentador de platos, inox

art.	dim. cm.	h.
41569-33	33x18	6,5
41569-45	45x18	6,5

Piastra in alluminio. - Aluminum plate.

Rechaud, faggio/inox
Plate warmer, beechwood & stainless steel
Speisenwärmer, Buche u. Edelstahl
Chauffe-plats, hêtre/inox
Calentador de platos, madera/inox

art.	dim. cm.	h. cm.	kg.
44251-01	16x16	2,5	0,66
44251-03	36x20	2,5	1,84



Fornello crêpes suzettes, inox
Flambé burner, stainless steel
Flambier-Rechaud, Edelstahl Rostfrei
Réchaud à flamber, inox
Calentador para flambear, inox

art.	ø cm.	h.
56162-00	18,5	28



Padella crêpes, inox
Flambé pan, stainless steel
Flambierpfanne, Edelstahl Rostfrei
Poêle à crêpes, inox
Sartén para crêpes, inox

art.	ø cm.
56163-27	27
56163-30	30



P

Cocotte per molluschi, ferro smaltato
Mussel pot, enamel cast-iron
Muscheltopf, emailliertes Stahlblech
Casserole coquillage, émaillée
Cacerola para mejillones, esmaltada

art.	ø cm.	cap. kg
42414-05	13,5	0,5
42414-10	18,0	1,0
42414-15	20,0	1,5
42414-20	24,0	2,0



Supporto con 4 spiedini, inox
Stand with 4 skewers, stainless steel
Träger mit 4 Fleischspiesen, Edelstahl
Support avec 4 brochettes, inox
Soporte con 4 brochetas, inox

art.	ø cm.	h.
42417-22	22	46



Servizio raclette, per 1-2 persone
Raclette cheese service, for 1-2 persons
Raclette-Service
Fondeuse à fromage
Fundidora de queso

art.	dim. cm.	h.	kg.
42420-01	15x16	27	1,2



Servizio raclette, ¼ di forma
Raclette cheese service, ¼ shape
Raclette-Service
Fondeuse à fromage
Fundidora de queso

art.	dim. cm.	h.	kg.	V	W
42420-04	28x24	34	3	230	600



Servizio raclette, ½ forma
Raclette cheese service, ½ shape
Raclette-Service
Fondeuse à fromage
Fundidora de queso

art.	dim. cm.	h.	kg.	V	W
42420-08	26,5x53	40	3,7	230	900

Piatto tipico svizzero a base di formaggio Raclette servito con patate bollite e sottaceti, pancetta affumicata tagliata a fettine sottili, pepe, paprika e vino bianco.
Traditional Swiss dish made of Raclette cheese and boiled potatoes accompanied by pickled vegetables, thinly sliced smoked bacon, pepper, paprika and white wine.



Cloche, inox
Dome cover, stainless steel
Speiseglocke, Edelstahl Rostfrei
Cloche, inox
Cubreplatos, inox

art.	dim. cm.	h.
41560-28	28	18



N

Sottopentola, sughero
Trivet, cork
Korkuntersetzer
Sous-plat, liège
Posavasos de corcho

art.	ø cm.	h.
42413-24	24	2



Raccoglibriciole
Crumb scraper
Krümelsammler
Ramasse miettes
Recogemigas

art.
42593-00



Raccoglibriciole a tubo, inox
Table crumbler, stainless steel
Krümelsammler, Edelstahl Rostfrei
Ramasse miettes, inox
Pala recogemigas, inox

art.	l. cm.
41679-23	23,5



Portarifiuti da tavola, plastica
Swing table top waste bin, plastic
Tischeimer, Kunststoff
Poubelle dé table, plastique
Papelera sobremesa, plástico

art.	ø cm.	h.
42959-13	12	18



Portarifiuti da tavola, inox
Swing table top waste bin, s/s
Tischeimer, 18-10 Edelstahl
Poubelle dé table, inox
Papelera sobremesa, inox

art.	ø cm.	h.
42959-12	12	17



P

Rompinoci
Nut-cracker
Nussknacker
Casse-noix
Cascanueces

art.
48211-00



P

Schiaccianoci, inox
Nut-cracker, stainless steel
Nussknacker, Edelstahl Rostfrei
Casse-noix, inox
Cascanueces, inox

art.	l. cm.
48210-00	16



Pinza aragosta, inox
Lobster cracker, stainless steel
Hummerzange, Edelstahl Rostfrei
Pince à homard, inox
Pinza bogavante, inox

art.	l. cm.
48239-00	20



Pinza aragosta, alluminio
Lobster cracker, aluminum
Hummerzange, Aluminum
Pince à homard, alu
Pinza bogavante, aluminio

art.
48240-00



Taglia ricci di mare, inox
Sea urchin cutter, stainless steel
Seeigel-Messer, Edelstahl Rostfrei
Coupe oursin, inox
Cortador de erizo de mar, inox

art. l. cm. gr. ø cm
48286-68 23 184 6



Stiletto aragosta, inox
Lobster pick, stainless steel
Hummergabel, Edelstahl Rostfrei
Curette à homard, inox
Tenedor bogavante, inox

art. l. cm.
48238-00 20



Forchettine per aragosta, inox
Lobster forks, stainless steel
Hummergäbelchen, Edelstahl Rostfrei
Curettes à homard, inox
Tenedores bogavante, inox

art. l. cm. u.pack
41594-18 18 5



Forchettine lumache, cromate
Escargot picks, chromed
Schnecken-gabel, verchromed
Pic-escargots, chromés
Pico-caracoles, cromado

art. u.pack
41686-12 12



Spilli, inox
Picks, stainless steel
Stocher, Edelstahl Rostfrei
Pic-bigorneaux, inox
Pico-caracoles, inox

art. u.pack
41594-12 12



Piatto lumache, inox
Escargot dish, stainless steel
Schneckenplatte, Edelstahl Rostfrei
Plat à escargots, inox
Plato caracoles, inox

art. pz/pcs
41687-06 6
41687-12 12



Coppa caviale, inox
Caviar cooler, stainless steel
Kaviarkühler, Edelstahl Rostfrei
Rafraichisseur à caviar, inox
Copa caviar, inox

art. ø cm. h.
41562-18 18 5



Posate caviale, madreperla
Caviar flatware, mother of pearl
Kaviar-Bestecke, Perlmuttern
Couverts à caviar, nacre
Cuberteria caviar, nácar

art. l. cm.
41518-00 11,5 spoon
41518-01 10,5 knife
41518-02 11,5 fork



Piatto frutti di mare, inox
Oyster plate, stainless steel
Austernplatte, Edelstahl Rostfrei
Plat à huîtres, inox
Fuente de mariscos, doble, inox

art. ø cm.
41591-90 45-36



Supporto acciaio cromato
Seafood display rack, chromed
Unterteil für Austernplatte, verchromt
Support en fil chromé
Soporte cromado para fuente mariscos

art. ø cm. h.
41593-20 19-25 20



Alzata Royale, inox
Fruit stand, stainless steel
Obstständer, Edelstahl Rostfrei
Etagère Royale, inox
Expositor de frutas, inox

art. ø cm. h.
41820-03 24-33-42 50



Vassoio frutti di mare, alluminio
Oyster tray, aluminum
Austernplatte, Aluminum
Plat à huîtres, alu
Fuente de mariscos, aluminio

art.	ø cm.	h.
41591-32	32	6
41591-36	36	6
41591-40	40	6
41591-45	45	6



Piatto frutti di mare, inox
Oyster plate, stainless steel
Austernplatte, Edelstahl Rostfrei
Plat à huîtres, inox
Fuente de mariscos, inox

art.	ø cm.	h.
42979-36	36	4,5
42979-45	45	5,5

Sotto il piatto è fissato un elemento di centraggio che lo mantiene ancorato alla colonna luminosa. - The plate has a centering element which keeps it anchored to the column.



Piatto frutti di mare, inox
Oyster plate, stainless steel
Austernplatte, Edelstahl Rostfrei
Plat à huîtres, inox
Fuente de mariscos, inox

art.	ø cm.	h.	lt.
41592-36	36	4,0	3
41592-45	45	5,5	7



Colonna luminosa per piatto frutti di mare
Lighting column for oyster plate
Lichtsäule für Austernplatte
Socle lumineux pour plat à huîtres
Columna luminosa para fuente de mariscos

art.	ø cm.	h.
42979-00	30	21



Composto da un piatto inox ø30 cm. e colonna in PMMA, scatola luci-LED e telecomando.
Stainless steel base plate ø30 cm., PMMA column, LED-light box and remote control.



Gancio appendi borsa, inox
Table bag holder, stainless steel
Handtaschentischhänger, Edelstahl Rostfrei
Crochet de table, inox
Colgador de bolso, inox

art.
41559-04



Supporto secchiello da tavola, cromato
Table clip for wine bucket, chrome
Tischbefestigung für Flaschenkühler, verchromt
Porte-seau à champagne, chromé
Soporte de mesa cubo champán, cromado

art.
41558-00
Per art.- For items: 41501-20 / 41502-20.



Secchiello vino, inox
Wine bucket, stainless steel
Sekt Kühler, Edelstahl Rostfrei
Seau à champagne, inox
Cubo champán, inox

art.	ø cm.	h.
41502-20	20	20



Secchiello champagne, alluminio
Champagne bucket, aluminum
Sektkühler, Aluminum
Seau à champagne, alu
Cubo champán, aluminio

art.	ø cm.	h.
41501-20	20	21



Secchiello vino, inox
Wine cooler, stainless steel
Weinkühler, Edelstahl Rostfrei
Seau à vin, inox
Cubo vino, inox

art.	ø cm.	h.	bottiglia-bottle
56120-18	18,5	16	1/2
56120-22	20,0	21	1
56120-24	24,0	22	2



Secchio vino bianco, inox
White wine cooler, stainless steel
Weissweinkühler, Edelstahl Rostfrei
Seau à vin blanc, inox
Cubo vino blanco, inox

art.	ø cm.	h.
56118-20	20	25



Portasecchiello, inox
Wine cooler stand, stainless steel
Ständer für Weinkühler, Edelstahl
Support pour seau à champagne, inox
Soporte para cubo, inox

art.	ø cm.	h.
41505-17	17,0	64,5
41505-19*	19,5	64,0



Colonna portasecchiello, inox
Wine cooler stand, stainless steel
Ständer für Weinkühler, Edelstahl
Support pour seau à champagne, inox
Soporte para cubo, inox

art.	ø cm.	h.
41505-20	20	70,5



Glacette termica
Bottle cooler
Flaschenkühler
Rafraîchisseur à bouteille
Enfriador isotérmico

art.	ø cm.	h.
41508C12	12	20



Glacette, cemento
Bottle cooler, beton
Flaschenkühler, Beton
Rafraîchisseur à bouteille, béton
Enfriador, cemento

art.	ø cm.	h.
41504-19	12-10	19



Glacette termica, inox
Bottle cooler, stainless steel
Flaschenkühler, Edelstahl Rostfrei
Rafraîchisseur à bouteille, inox
Enfriador isotérmico, inox

art.	ø cm.	h.
41504-09	9,5	22,5



Glacette termica, inox
Bottle cooler, stainless steel
Flaschenkühler, Edelstahl Rostfrei
Rafraîchisseur à bouteille, inox
Enfriador isotérmico, inox

art.	ø cm.	h.
41504-10	10	21

TAVOLA TABLE TOP



Glacette termica, inox
Bottle cooler, stainless steel
Flaschenkühler, Edelstahl Rostfrei
Rafraîchisseur à bouteille, inox
Enfriador isotérmico, inox

art.	ø cm.	h.
41508-10	10	30



Glacette termica
Bottle cooler
Flaschenkühler
Rafraîchisseur à bouteille
Enfriador isotérmico

art.	ø cm.	h.
41504-12	12,5	22

Camicia in materiale plastico, finitura effetto metallo satinato. - Noble plastic jacket in satin metal look.



Termobottiglia, PS
Bottle cooler, PS
Flaschenkühler, PS
Rafraîchisseur à bouteille, PS
Enfriador isotérmico, PS

art.	ø cm.	h.
41504-11	10	22



Glacette termica, acrilico
Double wall bottle cooler, acryl
Flaschenkühler, doppelwand, Acryl
Rafraîchisseur à double paroi, acrylique
Enfriador isotérmico, acrílico

art.	ø cm.	h.
41507-01	9,5	23



Secchiello vino, acrilico
Wine bucket, acryl
Weinkühler, Acryl
Seau à vin, acrylique
Cubo para botella, acrílico

art.	ø cm.	h.
44946-01	20	25
44946B01	20	25



Secchiello vino, acrilico
Wine bucket, acryl
Weinkühler, Acryl
Seau à vin, acrylique
Cubo para botella, acrílico

art.	dim. cm.	h.
44946-02	30,5x21,5	26,5



Secchiello vino, acrilico
Wine bucket, acryl
Weinkühler, Acryl
Seau à vin, acrylique
Cubo para botellas, acrílico

art.	ø cm.	h.
44946-03	18,5	23,5



Secchiello vino, acrilico
Wine bucket, acryl
Weinkühler, Acryl
Seau à vin, acrylique
Cubo para botella, acrílico

art.	dim. cm.	h.
44946-06	26x20	28,5



Secchiello vino, acrilico
Wine bucket, acryl
Weinkühler, Acryl
Seau à vin, acrylique
Cubo para botella, acrílico

art.	dim. cm.	h.
44946B06	26x20	28,5

**TAVOLA TABLE TOP
COMPLEMENTI SERVING ITEMS**



Cestino vino, argentato
Wine basket, silverplated
Weinkorb, versilbert
Panier à vin, argenté
Cesta para botella, plateado

art.
31509-01



Versavino a molla, inox
Wine holder, stainless steel
Weingestell, Edelstahl Rostfrei
Porte-Bouteille, inox
Soporte para botella, inox

art. ø cm.
41510-08 8



Versavino reversibile, inox
Wine holder, stainless steel
Weingestell, Edelstahl Rostfrei
Porte-bouteille, inox
Soporte para botella, inox

art. h. cm.
56123-00 17



P

Collare salvagoccia, cromato
Wine collar, chrome
Tropfenfänger, verchromt
Collier anti-gouttes, chromé
Anillo anti-goteo, cromado

art.
41511-00



Tastevin, inox
Wine taster, stainless steel
Weinprobenschale, Edelstahl Rostfrei
Tastevin, inox
Catador del vino, inox

art. ø cm.
41499-08 8,5



Scaldacognac, palladio
Cognac warmer, palladium
Cognacwärmer, Palladium
Réchaud à cognac, palladium
Calentador brandy, paladio

art. h. cm.
41678-14 14,5



N

Versatore, inox
Pouder, stainless steel
Ausgießer, Edelstahl Rostfrei
Verseur, inox
Vertedor, inox

art.
41511-20



N

Pinza champagne, cromata
Champagne tong, chromed
Champagner-Zange, verchromed
Pince à champagne, chromée
Pinza Champaña, cromada

art.
41511-30



N

Ossigenatore per vino
Wine aerator
Dekanter
Carafe à décanter
Decantador

art. ø cm. h.
41511-25 8 19

Ideale per ossigenare all'istante il vino.
Decants wine in seconds.



N

Sciabola per Sommelier
Champagne saber
Champagnersäbel
Sabra à champagne
Sable para Champán

art. l. cm.
41496-40 40



Vaso fiori, nichelato
Flower vase, nickel plated
Blumenvase, vernickelt
Vase à fleurs, nickelé
Florero, zinc-niquel

art. ø cm. h.
42942-16 4 16,5



Vaso fiori, inox
Flower vase, stainless steel
Blumenvase, Edelstahl Rostfrei
Vase à fleurs, inox
Florero, inox

art. h. cm.
41628-15 15



Candelieri, argentato
Candlestick, silverplated
Kerzenleuchter, versilbert
Chandelier, argenté
Candelabro una vela, plateado

art.	ø cm.	h.
32931-02	10	20,5



Candelabro 3 luci, argentato
Candelabra 3 lights, silverplated
Kerzenleuchter, 3-flammig, versilbert
Chandelier, 3 branches, argenté
Candelabro, 3 brazos, plateado

art.	ø cm.	h.
32931-03	10	22,5



Candelabro 5 luci, argentato
Candelabra 5 lights, silverplated
Kerzenleuchter, 5-flammig, versilbert
Chandelier, 5 branches, argenté
Candelabro, 5 brazos, plateado

art.	ø cm.	h.
32931-05	10	24



Candelieri, argentato
Candlestick, silverplated
Kerzenleuchter, versilbert
Chandelier, argenté
Candelabro una vela, plateado

art.	ø cm.	h.
32935-10	10	10
32935-22	10	22



Candelabro 5 luci, argentato
Candelabra 5 lights, silverplated
Kerzenleuchter, 5-flammig, versilbert
Chandelier, 5 branches, argenté
Candelabro, 5 brazos, plateado

art.	ø cm.	h.
42443-06	17	56
42443-08	24	78
42443-10	24	98



Candelabro 3 luci, argentato
Candelabra 3 lights, silverplated
Kerzenleuchter, 3-flammig, versilbert
Chandelier, 3 branches, argenté
Candelabro, 3 brazos, plateado

art.	ø cm.	h.
32935-03	11	25



Candelabro 5 luci, argentato
Candelabra 5 lights, silverplated
Kerzenleuchter, 5-flammig, versilbert
Chandelier, 5 branches, argenté
Candelabro, 5 brazos, plateado

art.	ø cm.	h.
32935-05	11	25



Candelabro 3 luci, argentato
Candelabra 3 lights, silverplated
Kerzenleuchter, 3-flammig, versilbert
Chandelier, 3 branches, argenté
Candelabro, 3 brazos, plateado

art.	ø cm.	h.
32936-03	13	39



Candelabro 5 luci, argentato
Candelabra 5 lights, silverplated
Kerzenleuchter, 5-flammig, versilbert
Chandelier, 5 branches, argenté
Candelabro, 5 brazos, plateado

art.	ø cm.	h.
32936-05	13	39



Portacandela, inox satinato, set 2 pz
Candleholder, s/s, satin finish, 2-pcs set
Windlicht, Edelstahl mattiert, 2-er Set
Bougeoir, inox satin mat, 2 pcs
Portavela, acero satinado, 2 pcs

art.	ø cm.	h.
42939-15	5	15



Portacandela, inox satinato, set 2 pz
Candleholder, s/s, satin finish, 2-pcs set
Windlicht, Edelstahl mattiert, 2-er Set
Bougeoir, inox satin mat, 2 pcs
Portavela, acero satinado, 2 pcs

art.	ø cm.	h.
42440-22	8	22



Portacandela, cromata
Candleholder, chrome-plated
Windlicht, Metall verchromt
Bougeoir, acier chromé
Portavela, acero cromado

art.	ø cm.	h.
42941-22	11	22



N

Portacandela, inox lucido
Candleholder, s/s mirror finish
Windlicht, Edelstahl poliert
Bougeoir, inox poli brillant
Portavela, inox acabado espejo

art.	ø cm.	h.
42442-12	12	11,5



N

Porta menù, inox
Menu stand, stainless steel
Speisekartenhalter, Edelstahl Rostfrei
Porte-menu, inox
Portamenús, inox

art.	dim. cm.	h.
42951-14	14x5,5	14



N

Porta menù, metallo cromato
Menu stand, chromed steel
Speisekartenhalter, Metall Verchromt
Porte-menu, Métal Chromé
Portamenús, Metal Cromado

art.	dim. cm.	h.
42951-13	9,5x7,5	13,5



Porta menù, inox
Menu stand, stainless steel
Speisekartenhalter, Edelstahl Rostfrei
Porte-menu, inox
Portamenús, inox

art.	dim. cm.	h.
42951-08	8x7	2



Supporto numero tavola, inox
Table number stand, stainless steel
Tischnummerständer, Edelstahl Rostfrei
Support numéro de table, inox
Soporte número de mesa, inox

art.	ø cm.	h.
42954-04	4	10



Supporto numero tavola, inox
Table number stand, stainless steel
Tischnummerständer, Edelstahl Rostfrei
Support numéro de table, inox
Soporte número de mesa, inox

art.	ø cm.	h.
42954-18	7,5	18,5
42954-29	7,5	29,0
42954-46	7,5	46,0



Supporto targhetta, inox
Card holder, stainless steel
Kartenhalter, Edelstahl Rostfrei
Porte-cartes, inox
Portatarjetas, inox

art.	dim. cm.	h.
42952-05	6x5	3



Targhetta da tavola, inox
Table sign, stainless steel
Tischaufsteller, Edelstahl Rostfrei
Plaque de table, inox
Placa de mesa, inox

art.	dim. cm.	h.	u.pack
42951-58	5,5x5	3,5	2



Targhetta da tavola, inox
Table sign, stainless steel
Tischaufsteller, Edelstahl Rostfrei
Plaque de table, inox
Placa de mesa, inox

art.	dim. cm.	h.	u.pack
42951-57	5,5x5	3,5	2

TAVOLA TABLE TOP



Targhette numeri, inox satinato
Table numbers, s/s satin finish
Tischnummernschild, Edelstahl mattiert
Plaquettes nombres, inox satin mat
Números de mesa, acero satinado

Simbolo per porta
Sign plate
Türsymbol
Plaquette de porte
Placa para puerta

Targhetta da tavola, inox
Table sign, stainless steel
Tischaufsteller, Edelstahl Rostfrei
Plaquette de table, inox
Placa de mesa, acero

art.	dim. cm.	nr.	pz/pcs.
42958-00	5,3x4,5	1-12	12
42958-01	5,3x4,5	13-24	12
42958-02	5,3x4,5	25-36	12
42958-03	5,3x4,5	37-48	12
42958-04	5,3x4,5	49-60	12
42958-05	5,3x4,5	61-72	12

art.	ø cm.
42958-28	16 SMOKING
42958-29	16 NO SMOKING

art.	dim. cm.	h.	u.pack
42951-59	5,5x5	3,5	2

art.	ø cm.
42958-11	7,5 LADIES
42958-12	7,5 GENTS
42958-13	7,5 LADIES/GENTS
42958-14	7,5 DISABLED
42958-15	7,5 WC
42958-18	7,5 PLEASE SIT
42958-16	7,5 SMOKING

art.	ø cm.
42958-17	7,5 NO SMOKING
42958-19	7,5 COATS
42958-20	7,5 NO MOBILES
42958-23	7,5 PULL
42958-24	7,5 PUSH
42958-26	7,5 NO ENTRY



Pittrogrammi, inox
Sign plates, stainless steel
Türsymbol, Edelstahl Rostfrei
Pictogrammes, inox
Pictogramas, inox



Acciaio inox spazzolato, spessore 1 mm. stampa serigrafica nera, adesivo posteriore.
Stainless steel satin polished, material thickness 1 mm., black screenprint, self-adhesive back.



Campanella reception, inox
Reception bell, stainless steel
Receptionsschell, Edelstahl
Sonette de réception, inox
Timbre recepción, inox

art.	ø cm.	h.
41390-00	8,5	6



Tagliasigari da tavola
Table cigar cutter
Zigarrenschneider
Coupe-cigares
Guillotina para puros

art.
48244-07

Modelli assortiti. - Assorted models.



Forbice sigari, inox
Cigar scissors, stainless steel
Zigarrenscherer, Edelstahl Rostfrei
Ciseaux à cigares, inox
Cortador para puros, inox

art.	dim. cm.
48245-10	10x5



Vetrina sigari
Cigar humidor
Zigarren-Vitrine
Vitrine à cigares
Vitrina para puros

art.	dim. cm.	h.
48245-75	30x24	14,5

Per c.ca 40 sigari, con umidificatore, separatore interno, vassoio estraibile, igrometro esterno. - Holds about 40 cigars, with hygrometer, humidifier, tray and removable divider.



Tagliasigari da tavola
Table cigar cutter
Zigarrenschneider
Coupe-cigares
Guillotina para puros

art.	dim. cm.
48244-04	9x4



Tagliasigari da tavola, inox
Table cigar cutter, stainless steel
Zigarrenschneider, Edelstahl Rostfrei
Coupe-cigares, inox
Guillotina para puros, inox

art.	dim. cm.
48242-09	9x4



Portasigaro con piattino, inox
Cigar ashtray, stainless steel
Aschenbecher mit Zigarrenhalter
Cendrier à cigares, inox
Cenicero para puros, inox

art. ø cm.
48241-14 14,5



Posacenere, porcellana
Ashtray, porcelain
Aschenbecher, Porzellan
Cendrier en porcelaine
Cenicero de porcelana

art. ø cm.
44366-10 10



Posacenere impilabile, inox
Ashtray, stackable, stainless steel
Aschenbecher, stapelbar, Edelstahl
Cendrier empilable, inox
Cenicero, inox

art. ø cm.
48247-10 10



Posacenere impilabile, inox
Ashtray, stackable, stainless steel
Aschenbecher, stapelbar, Edelstahl
Cendrier empilable, inox
Cenicero, apilable, inox

art. ø cm.
48248-16 16



Posacenere impilabile, inox
Ashtray, stackable, stainless steel
Aschenbecher, stapelbar, Edelstahl
Cendrier empilable, inox
Cenicero, apilable, inox

art. ø cm. h.
48250-10 10 4,5



Posacenere impilabile, inox
Ashtray, stackable, stainless steel
Aschenbecher, stapelbar, Edelstahl
Cendrier empilable, inox
Cenicero, apilable, inox

art. ø cm. h.
48250-12 12 4,5



Posacenere, cromato
Ashtray, chrome plated
Aschenbecher, Metall hartverchromt
Cendrier, chromé
Cenicero, cromado

art. ø cm. h.
48249-13 13 10,5



Set 3 posaceneri impilabili
3-piece ashtray set, stackable
Satz 3 Stk Aschenbecher, stapelbar
Set 3 pièces Cendrier empilable
Juego 3 pz cenicero, apilable

art. ø cm. h.
48251-03 7,8 3



Posacenere impilabile, antiscivolo
Ashtray, stackable, non slip
Aschenbecher, stapelbar
Cendrier empilable
Cenicero, apilable

art. ø cm. h.
48252-10 10 4,0
48252-12 12 4,3



MF

Posacenere impilabile, antiscivolo
Ashtray, stackable, non slip
Aschenbecher, stapelbar
Cendrier empilable
Cenicero, apilable

art. ø cm. h.
48252B10 10 4,0
48252B12 12 4,3



MF

Posacenere impilabile, antiscivolo
Ashtray, stackable, non slip
Aschenbecher, stapelbar
Cendrier empilable
Cenicero, apilable

art. ø cm. h.
48253-09 9,5 4



MF

Posacenere impilabile, antiscivolo
Ashtray, stackable, non slip
Aschenbecher, stapelbar
Cendrier empilable
Cenicero, apilable

art. ø cm. h.
48253B09 9,5 4

PEUGEOT

MACINE
MILLS



MECCANISMI - MECHANISMS

PEPE - PEPPER



Il meccanismo è dotato di una doppia fila di denti elicoidali che catturano il grano, lo spingono verso il basso e lo bloccano per macinarlo perfettamente. Subisce un trattamento brevettato che protegge l'acciaio dalla corrosione pur mantenendo la sua affilatura e resistenza all'usura. Per ottenere i migliori risultati, si consiglia di utilizzare solo pepe in grani secchi da 5 mm o meno di diametro. Si possono macinare pepe verde, nero, e bianco. Le bacche rosse possono essere macinate solo se miscelate (max 15%) con altri grani di pepe. Semi di coriandolo secchi sono anch'essi adatti per il meccanismo macina pepe.

The pepper mechanism is equipped with a helix-shaped double row of teeth that guide and hold the peppercorns for a perfect grind. It has a patented treatment that protects the steel from corrosion while maintaining its sharpness and wear resistance. To get the best out of your Peugeot pepper grinding mechanism, we recommend to use peppercorns with a diameter of 5 mm (1/4") or less. Black, white and dry green peppercorns can be ground in Peugeot pepper mills. The pink berries can be ground only if in a blend (max 15% pink) with one of these other peppercorns. Dried coriander is also suitable for the pepper mechanism.

SALE - SALT



Il meccanismo per il sale Peugeot è disegnato per macinare sale marino grosso. Realizzato in acciaio inossidabile resiste alla corrosione provocata dal sale asciutto. Non usare con pepe ed altre spezie, con sale di mare umido o con fiore di sale (Guérande, Ré, Malton, sel rose...). Per ottimizzare la resa del meccanismo si consiglia di utilizzare sale con un diametro di 4 mm.

The Peugeot salt mechanism is designed to grind cooking salt. It is made of stainless steel and is not sensitive to salt corrosion. To get the best out of your Peugeot salt grinding mechanism, you should use: salt with a diameter of 4 mm (3/16") or dry coarse salt: dry sea salt or rock salt. Do not use for pepper or any other spice. Do not use with wet sea salt or flowers of salt, Guérande, Ré, Maldon, pink salt, etc.

SALE UMIDO - WET SEA SALT



Un innovativo sistema brevettato appositamente progettato per sale marino bagnato la cui consistenza naturale ed il contenuto di umidità non permettono l'uso di un comune macinasale. Il meccanismo assicura un'ottima macina, un'uscita costante, e una spirale che mescola il sale affinché non si attacchi. Esclusivo meccanismo di ceramica, Made in France.

A specially designed mill for wet sea salt. The natural consistency and moisture content do not allow the use of an ordinary salt mill. Innovative patented system for a high-performance grind without blockage even with very humid or compressed salt. This specific mechanism is composed of 3 stops ensuring both mechanism resistance and constant output, and an anti-clogging spiral which shuffles the salt in the reservoir. Peugeot ceramic exclusive mechanism, Made in France.

PEPERONCINO - CHILI PEPPER



Questo meccanismo è un prodotto esclusivo Peugeot. Il modello brevettato ha un sistema di pre-taglio e un meccanismo che permettono di macinare il peperoncino essiccato. Come il macinapepe, il meccanismo subisce un trattamento brevettato che protegge l'acciaio dalla corrosione pur mantenendo la sua affilatura e resistenza all'usura.

The chili pepper mechanism is a Peugeot exclusive product. This patented model has a pre-cutting system and a mechanism that grinds dry chili pepper. Like the pepper grinder it has a patented treatment that protects the steel from corrosion while maintaining its sharpness and wear resistance.

NOCE MOSCATA - NUTMEG



La macina è dotata di una doppia lama per grattugiare in acciaio inox e di un robusto dischetto uncinato che permette di grattugiare l'intera noce molto finemente.

The Peugeot nutmeg mill is equipped with a double stainless steel blade/grater and a strong claw which enables the nutmeg to be very finely ground.

IMPOSTAZIONE DELLA MACINA - ADJUSTABLE GRINDING SYSTEM

PER MACINE MANUALI ED ELETTRICHE - FOR ELECTRIC OR MANUAL MILLS

Sistema brevettato che permette una regolazione predefinita della macinatura. 6 Livelli per il pepe e 6 Livelli per il sale. Facile: basta ruotare l'anello alla base della macina e selezionare una delle posizioni, ognuna corrisponde ad una determinata grana.

Patented system that enables precise grind adjustment settings. 6 pre-defined levels of grind for pepper and 6 for salt. Easy: just rotate the ring at the base of the mill and select one of the positions, each corresponding to a specific grain.

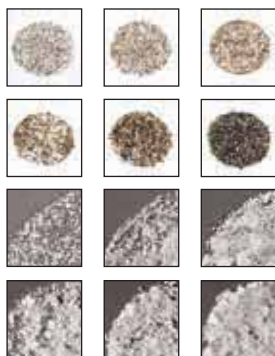

REGOLAZIONE CLASSICA - CLASSIC ADJUSTABLE SYSTEM

Negli apparecchi elettrici la rotella di regolazione si trova sotto il meccanismo di macinatura. Negli apparecchi manuali la regolazione si effettua ruotando il dado/pomolino. Ruotare in senso orario per ottenere una macinatura più fine, in senso antiorario per ottenere una macinatura più grossa.

Thumbwheel grind adjustment on electric grinders is found below the grinding mechanism. Grind adjustment nut on manual mills, turn the nut. Clockwise to obtain a finer grind, counter-clockwise to obtain a coarser grind.





ALASKA - Duo, macina pepe/sale, elettrici
Duo, electric pepper/salt mill
Duo, Pfeffer-/Salzmühle
Duo, moulin à poivre/sel
Duo, molinillo pimienta/sal

art. h. cm.

42660-02 17

Polycarbonato/Acrylic. Forniti con 6 batterie e lampadina.
Polycarbonate/Acrylic. Fitted with: 6 batteries - spare bulb.



ELIS SENSE - Macina pepe/sale
Pepper/salt mill
Pfeffer-/Salzmühle
Moulin à poivre/sel
Molinillo pimienta/sal

art.-P art.-S h. cm.

42785S20 42786S20 20

Inox. Dotati di led e forniti con 6 batterie (si possono utilizzare anche batterie ricaricabili), vassoietto e fiala dosatrice con imbuto. - Stainless steel. Fitted with LED, 6 batteries (can also work with rechargeable batteries), a small dish and a pre-measured spice vial with funnel.



ELIS RICARICABILE - Macina pepe/sale
Pepper/salt mill
Pfeffer-/Salzmühle
Moulin à poivre/sel
Molinillo pimienta/sal

art.-P art.-S h. cm.

42785R20 42786R20 20

Inox. Forniti con carica batterie, vassoietto e lampadina.
Stainless steel. Fitted with: rechargeable battery - tray - spare bulb.



ONYX - Macina pepe/sale
Pepper/salt mill
Pfeffer-/Salzmühle
Moulin à poivre/sel
Molinillo pimienta/sal

art.-P art.-S h. cm.

42800P20 42800S20 20

Soft touch. Forniti con 6 batterie e lampadina. - Soft touch. Fitted with: 6 batteries - spare bulb.



ZEPHIR - Macina pepe/sale
Pepper/salt mill
Pfeffer-/Salzmühle
Moulin à poivre/sel
Molinillo pimienta/sal

art.-P art.-S h. cm.

42692B14 42693B14 14

ABS imitazione inox. - Soft touch. Forniti con 4 batterie. - ABS stainless steel look. - Soft touch. Fitted with: 4 batteries.



ZELI - Macina pepe/sale
Pepper/salt mill
Pfeffer-/Salzmühle
Moulin à poivre/sel
Molinillo pimienta/sal

art.-P art.-S h. cm.

42801P14 42801S14 14

ABS imitazione inox. Forniti con 4 batterie. - ABS stainless steel look. Fitted with: 4 batteries.





BISTRO - Macina pepe/sale
Pepper/salt mill
Pfeffer-/Salzmühle
Moulin à poivre/sel
Molinillo pimienta/sal

art.-P	art.-S	h. cm.
42701-10	42703-10	10

Faggio - naturale.
Beech wood - natural.



BISTRO - Macina pepe/sale
Pepper/salt mill
Pfeffer-/Salzmühle
Moulin à poivre/sel
Molinillo pimienta/sal

art.-P	art.-S	h. cm.
42702-10	42704-10	10

Faggio - cioccolato.
Beech wood - chocolate.



BISTRO - Macina pepe/sale
Pepper/salt mill
Pfeffer-/Salzmühle
Moulin à poivre/sel
Molinillo pimienta/sal

art.-P	art.-S	h. cm.
42702P10	42704S10	10

Faggio - nero opaco.
Beech wood - black matt.



BISTRO - Macina pepe/sale
Pepper/salt mill
Pfeffer-/Salzmühle
Moulin à poivre/sel
Molinillo pimienta/sal

art.-P	art.-S	h. cm.
42701P10	42703S10	10

Faggio - bianco opaco.
Beech wood - white matt.



BISTRO ANTIQUE - Macina pepe/sale
Pepper/salt mill
Pfeffer-/Salzmühle
Moulin à poivre/sel
Molinillo pimienta/sal

art.-P	art.-S	h. cm.
42705P10	42705S10	10

Faggio - Beech wood.



BISTRO CHEF - Macina pepe/sale
Pepper/salt mill
Pfeffer-/Salzmühle
Moulin à poivre/sel
Molinillo pimienta/sal

art.-P	art.-S	h. cm.
42624P10	42624S10	10

Inox. - Stainless steel.



PARIS ANTIQUE - Macina pepe/sale
Pepper/salt mill
Pfeffer-/Salzmühle
Moulin à poivre/sel
Molinillo pimienta/sal

art.-P	art.-S	h. cm.
42749P18	42749S18	18
42749P22	42749S22	22
42749P30		30

Faggio. - Beech wood.



PARIS - Macina pepe/sale
Pepper/salt mill
Pfeffer-/Salzmühle
Moulin à poivre/sel
Molinillo pimienta/sal

art.-P	art.-S	h. cm.
42746P12		12
42746P18	42746S18	18
42746P22	42746S22	22
42746P30	42746S30	30
42746P40		40
42746P50		50
42746P80		80

Faggio - cioccolato.
Beech wood - chocolate.



PARIS - Macina pepe/sale
Pepper/salt mill
Pfeffer-/Salzmühle
Moulin à poivre/sel
Molinillo pimienta/sal

art.-P	art.-S	h. cm.
42747P12	42747S12	12
42747P18	42747S18	18

Faggio - laccato nero.
Beech wood - black lacquered.



PARIS - Macina pepe/sale
Pepper/salt mill
Pfeffer-/Salzmühle
Moulin à poivre/sel
Molinillo pimienta/sal

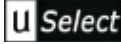

art.-P	art.-S	h. cm.
42665P12	42665S12	12
42665P18	42665S18	18
42665P22	42665S22	22
42665P27	42665S27	27
42665P30	42665S30	30
42665P40	42665S40	40

Faggio - naturale.
Beech wood - natural.



PARIS - Macina pepe/sale
Pepper/salt mill
Pfeffer-/Salzmühle
Moulin à poivre/sel
Molinillo pimienta/sal



art.-P	art.-S	h. cm.
42667P12	42667S12	12
42667P18	42667S18	18
42667P22	42667S22	22
42667P30	42667S30	30

Faggio - laccato nero.
Beech wood - black lacquered.



PARIS - Macina pepe/sale
Pepper/salt mill
Pfeffer-/Salzmühle
Moulin à poivre/sel
Molinillo pimienta/sal

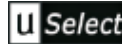

art.-P	art.-S	h. cm.
42666P12	42666S12	12
42666P18	42666S18	18
42666P22	42666S22	22
42666P27	42666S27	27
42666P30	42666S30	30
42666P40	42666S40	40

Faggio - cioccolato.
Beech wood - chocolate.



PARIS CHEF - Macina pepe/sale
Pepper/salt mill
Pfeffer-/Salzmühle
Moulin à poivre/sel
Molinillo pimienta/sal

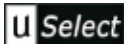

art.-P	art.-S	h. cm.
42674P18	42674S18	18
42674P22	42674S22	22
42674P30	42674S30	30

Acciaio inox. - Stainless steel.



PARIS - Macina pepe/sale
Pepper/salt mill
Pfeffer-/Salzmühle
Moulin à poivre/sel
Molinillo pimienta/sal

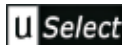

art.-P	art.-S	h. cm.
42664P12	42664S12	12
42664P18	42664S18	18
42664P22	42664S22	22
42664P30	42664S30	30
42664P40		40

Faggio - laccato bianco.
Beech wood - white lacquered.



PARIS - Macina pepe/sale
Pepper/salt mill
Pfeffer-/Salzmühle
Moulin à poivre/sel
Molinillo pimienta/sal

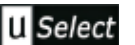

art.-P	art.-S	h. cm.
42668P12	42668S12	12
42668P18	42668S18	18
42668P22	42668S22	22
42668P30	42668S30	30
42668P40		40

Faggio - laccato rosso.
Beech wood - red lacquered.

**TAVOLA TABLE TOP
PEUGEOT MACINE MILLS**



CHÂTEL - Macina pepe/sale
Pepper/salt mill
Pfeffer-/Salzmühle
Moulin à poivre/sel
Molinillo pimienta/sal

art.-P	art.-S	h. cm.
42707P21	42707S21	21
Noce. - Walnut.		
42709P21	42709S21	21
Citiegio. - Wild cherry.		



HOSTELLERIE - Macina pepe
Pepper mill
Pfeffermühle
Moulin à poivre
Molinillo pimienta

art.	h. cm.
42741-22	22
Faggio - naturale. Beech wood - natural.	
42742-22	22
Faggio - cioccolato. Beech wood - chocolate.	



TOKYO - Macina pepe/sale
Pepper/salt mill
Pfeffer-/Salzmühle
Moulin à poivre/sel
Molinillo pimienta/sal

N

art.-P	art.-S	h. cm.
42675P16	42675S16	16
Faggio. - Beech wood.		



ROYAN - Macina pepe/sale
Pepper/salt mill
Pfeffer-/Salzmühle
Moulin à poivre/sel
Molinillo pimienta/sal

N

art.-P	art.-S	h. cm.
42677P14	42677S14	14



COTTAGE - Macina pepe/sale
Pepper/salt mill
Pfeffer-/Salzmühle
Moulin à poivre/sel
Molinillo pimienta/sal

art.-P	art.-S	h. cm.
42672P22		22
Faggio - laccato grigio. Beech wood - gray lacquered.		
art.-P	art.-S	h. cm.
	42672S22	22
Faggio - laccato avorio. Beech wood - ivory lacquered.		



u Select

CHATEAUNEUF - Macina pepe/sale
Pepper/salt mill
Pfeffer-/Salzmühle
Moulin à poivre/sel
Molinillo pimienta/sal

art.-P	art.-S	h. cm.
42781-23	42783-23	23
42781-30	42783-30	30
Inox-faggio - nero opaco. - Stainless steel-beech wood - black matt.		



U Select

MADRAS - Macina pepe/sale
Pepper/salt mill
Pfeffer-/Salzmühle
Moulin à poivre/sel
Molinillo pimienta/sal

art.-P	art.-S	h. cm.
42705P16	42705S16	16
42705P21	42705S21	21

Inox - faggio - cioccolato. - Stainless steel - beech wood - chocolate.



N

MADRAS - Macina noce moscata
Nutmeg mill
Muskatmühle
Moulin à mouscade
Molinillo nuez moscada

art.	h. cm.
42705M15	15

Inox - faggio - cioccolato. - Stainless steel - beech wood - chocolate.



FIDJI - Macina pepe/sale
Pepper/salt mill
Pfeffer-/Salzmühle
Moulin à poivre/sel
Molinillo pimienta/sal

art.-P	art.-S	h. cm.
42767P12	42767S12	12
42767P15	42767S15	15
42767P20	42767S20	20

Inox - faggio - nero opaco. - Stainless steel - beech wood - black matt.



N

FIDJI OLIVE - Macina pepe/sale
Pepper/salt mill
Pfeffer-/Salzmühle
Moulin à poivre/sel
Molinillo pimienta/sal

art.-P	art.-S	h. cm.
42676P15	42676S15	15
42676P20	42676S20	20

Inox - ulivo.
Stainless steel - Olive wood.



U Select

DAMAN - Macina pepe/sale
Pepper/salt mill
Pfeffer-/Salzmühle
Moulin à poivre/sel
Molinillo pimienta/sal

art.-P	art.-S	h. cm.
42764P16	42764S16	16
42764P21	42764S21	21

Inox - acrilico.
Stainless steel - acrylic.



N

DAMAN - Macina sale dell'Himalaya
Himalaya salt mill
Himalaya-/Salzmühle
Moulin à sel de l'Himalaya
Molinillo pimienta/sal

art.	h. cm.
42764H16	16
42764H21	21

Inox - acrilico.
Stainless steel - acrylic.



N

DAMAN - Macina noce moscata
Nutmeg mill
Muskatmühle
Moulin à mouscade
Molinillo nuez moscada

art.	h. cm.
42764M15	15

Inox - acrilico.
Stainless steel - acrylic.



BRASSERIE - Duo, macina pepe/sale
Duo, pepper/salt mill
Duo, Pfeffer-/Salzmühle
Duo, moulin à poivre/sel
Duo, molinillo pimienta/sal

art.	h. cm.
42710-11	11

ABS cromato - acrilico.
ABS chromed - acrylic.



U Select

COMMERCY - Macina pepe/sale
Pepper/salt mill
Pfeffer-/Salzmühle
Moulin à poivre/sel
Molinillo pimienta/sal

art.-P	art.-S	h. cm.
42780P15	42780S15	15

Inox - acrilico.
Stainless steel - acrylic.

**TAVOLA TABLE TOP
PEUGEOT MACINE MILLS**



METZ - Macina pepe/sale
Pepper/salt mill
Pfeffer-/Salzmühle
Moulin à poivre/sel
Molinillo pimienta/sal

art.-P	art.-S	h. cm.
42799P10	42799S10	10

Acrilico. - Acrylic.



BALI - Macina pepe
Pepper mill
Pfeffer-Mühle
Moulin à poivre
Molinillo pimienta

art.	h. cm.	Col.
42661-02	8	●
42661-03	8	●

Acrilico/ABS. - Acrylic/ABS



BALI - Macina sale
Salt mill
Salzmühle
Moulin à sel
Molinillo sal

art.	h. cm.	Col.
42661-06	8	○

Acrilico/ABS. - Acrylic/ABS



CHAUMONT - Macina pepe/sale
Pepper/salt mill
Pfeffer-/Salzmühle
Moulin à poivre/sel
Molinillo pimienta/sal

art.-P	art.-S	h. cm.
42798P11	42798S11	11
42798P16	42798S16	16

Acrilico. - Acrylic.



VITTE L - Macina pepe/sale
Pepper/salt mill
Pfeffer-/Salzmühle
Moulin à poivre/sel
Molinillo pimienta/sal

art.-P	art.-S	h. cm.
42796P16	42796S16	16
42796P23	42796S23	23
42796P30	42796S30	30

Acrilico. - Acrylic.



NANCY - Macina pepe/sale
Pepper/salt mill
Pfeffer-/Salzmühle
Moulin à poivre/sel
Molinillo pimienta/sal

art.-P	art.-S	h. cm.
42727-09	42728-09	9
42727-12	42728-12	12
42727-18	42728-18	18
42727-22	42728-22	22
42727-30	42728-30	30
42727-38	42728-38	38

Acrilico. - Acrylic.



NANCY - Macina sale Himalaya
Himalaya salt mill
Himalaya-/Salzmühle
Moulin à sel de l'Himalaya
Molinillo pimienta/sal

art.	h. cm.
42728H18	18

Acrilico. - Acrylic.



NANCY - Macina per sale umido
Wet sea salt mill
Mühle für Feuchtes Meersalz
Moulin à sel humide
Molinillo sal húmeda

art.	h. cm.
42728S18	18

Acrilico. - Acrylic.



Macina per sale umido
Wet sea salt mill
Mühle für Feuchtes Meersalz
Moulin à sel humide
Molinillo sal húmeda

art.	h. cm.	
42670N14	14	naturale/natural

Acrilico - faggio. - Acrylic - beech wood.



Macina per sale umido
Wet sea salt mill
Mühle für Feuchtes Meersalz
Moulin à sel humide
Molinillo sal húmeda

art.	h. cm.	
42670B14	14	cioccolato/cocholate

Acrilico - faggio. - Acrylic - beech wood.



Macina per sale umido
Wet sea salt mill
Mühle für Feuchtes Meersalz
Moulin à sel humide
Molinillo sal húmeda

art.	h. cm.	
42670W14	14	bianco/white

Acrilico. - Acrylic.



OUESSANT - Macina pepe/sale
Pepper/salt mill
Pfeffer-/Salzmühle
Moulin à poivre/sel
Molinillo pimienta/sal

art.-P	art.-S	h. cm.
42669P14	42669S14	14

Acrilico - inox.
Acrylic - stainless steel.



OUESSANT - Macina erbe/peperoncino
Herbs/chili mill
Kräuter-/Paprikamühle
Moulin à herbes/piment
Molinillo hierbas/chile

art.	h. cm.
42669C14	14

Acrilico - inox.
Acrylic - stainless steel.



OLERON - Macina pepe/sale
Pepper/salt mill
Pfeffer-/Salzmühle
Moulin à poivre/sel
Molinillo pimienta/sal

art.-P	art.-S	h. cm.
42663P14	42663S14	14

Acrilico - faggio - cioccolato.
Acrylic - beech wood - chocolate.



OLERON - Macina erbe/peperoncino
Herbs/chili mill
Kräuter-/Paprikamühle
Moulin à herbes/piment
Molinillo hierbas/chile

art.	h. cm.
42663C14	14

Acrilico - faggio - cioccolato.
Acrylic - beech wood - chocolate.



OLERON - Macina pepe/sale
Pepper/salt mill
Pfeffer-/Salzmühle
Moulin à poivre/sel
Molinillo pimienta/sal

art.-P	art.-S	h. cm.
42662P14	42662S14	14

Acrilico - faggio - naturale.
Acrylic - beech wood - natural.

OLERON - Macina erbe/peperoncino
Herbs/chili mill
Kräuter-/Paprikamühle
Moulin à herbes/piment
Molinillo hierbas/chile

art.	h. cm.
42662C14	14

Acrilico - faggio - naturale.
Acrylic - beech wood - natural.



TERNATE - Macina noce moscata
Nutmeg mill
Muskatmühle
Moulin à mouscade
Molinillo nuez moscada

art.	h. cm.
42720-00	11

Acrilico/ABS cromato.
Acrylic/ABS chromed.



TIDORE - Macina noce moscata
Nutmeg mill
Muskatmühle
Moulin à mouscade
Molinillo nuez moscada

art.	h. cm.
42720-01	11

Acrilico. - Acrylic.



PALACE - Macina pepe/sale
Pepper/salt mill
Pfeffer-/Salzmühle
Moulin à poivre/sel
Molinillo pimienta/sal

art.-P	art.-S	h. cm.
42725P10	42725S10	10

Metallo argentato - legno.
Silverplated - wood.



MIGNONNETTE - Macina pepe/sale
Pepper/salt mill
Pfeffer-/Salzmühle
Moulin à poivre/sel
Molinillo pimienta/sal

art.-P	art.-S	h. cm.
42723P10	42723S10	10

Metallo argentato. - Silverplated.

ICE-CREAM BAR BUFFET

GELATERIA, BAR, BUFFET
ICE-CREAM, BAR, BUFFET
EIS-ARTIKEL, BAR, BUFFET
GLACE, BAR, BUFFET
HELADERÍA, BAR, BUFFET

GELATERIA - *ICE CREAM*





Coppa gelato, MS
Ice cream cup, MS
Eisbecher, MS
Coupe à glace, MS
Copa helado, MS

art.	h. cm.	lt.	u. pack
44942-10	16	0,25	6



Coppa gelato, MS
Ice cream cup, MS
Eisbecher, MS
Coupe à glace, MS
Copa helado, MS

art.	h. cm.	lt.	u. pack
44942-11	11	0,38	6



Coppa gelato, MS
Ice cream cup, MS
Eisbecher, MS
Coupe à glace, MS
Copa helado, MS

art.	h. cm.	lt.	u. pack
44942-12	6,5	0,26	6



Coppa macedonia, MS
Fruit cup, MS
Fruchtschale, MS
Coupe à dessert, MS
Copa frutas, MS

art.	Ø cm.	h.	u. pack
44942-07	10	10	6



Coppa gelato, MS
Ice cream cup, MS
Eisbecher, MS
Coupe à glace, MS
Copa helado, MS

art.	Ø cm.	h.	u. pack
44942-06	9	19	6



Vassoio Gourmet, melamina
Tray Gourmet, melamine
Tablett GOURMET, Melamin
Plateau, melamine
Bandeja, melamine

art.	dim. cm.	h.	Ø holes
44466-30	30,5x9,5	2,5	4



Ciotoline Gourmet, melamina
Bowl gourmet, melamine
Schälchen GOURMET, Melamin
Bol, melamine
Bols, melamine

art.	Ø cm.	h.	ml.
44466-07	7	6	50



Porta conì, inox
Ice cream cone holder, stainless steel
Eiswaffelständer, Edelstahl Rostfrei
Porte cornets à glace, inox
Soporte para cucuruuchos, inox

art.	dim. cm.	h.	Ø mm.
41472-01	20x9,5	8,5	26



Porta conì, inox
Ice cream cone holder, stainless steel
Eiswaffelständer, Edelstahl Rostfrei
Porte cornets à glace, inox
Soporte para cucuruuchos, inox

art.	dim. cm.	h.
41472-04	16,5	14



Porta conì, plexiglas
Ice cream cone holder, plexiglas
Eiswaffelständer, Plexiglas
Porte cornets à glace, plexiglas
Soporte para cucuruuchos, plexiglas

art.	Ø cm.	h.
41472-05	19	24



Contenitore per cialde, plexiglas
Waffle case, plexiglas
Waffelbehälter, Plexiglas
Porte gaufres, plexiglas
Contenedor para waffles, plexiglas

art.	dim. cm.	h.
41472-21	22x26	12



Porta coppette girevole, plexiglas
Revolving bowls holder, plexiglas
Schalenspender, Plexiglas
Porte pot à glace, pivotant
Soporte para bols, giratorio, plexiglas

art.	ø cm.	h.	int.
41472-10	25	35	9x9



Porta palette, plexiglas
Spoon case, plexiglas
Eislöffelbehälter, Plexiglas
Porte cuilleres à glace, plexiglas
Contenedor cuciaritas, plexiglas

art.	dim. cm.	h.
41472-20	19x12,5	14



Porta cannucce, plexiglas
Straws holder, plexiglas
Strohalmbehälter, plexiglas
Porte chalumeaux, plexiglas
Porta canutillos, plexiglas

art.	dim. cm.	h.
41472-22	26x17	22



Porta coni girevole, plexiglas
Revolving cones dispenser, plexiglas
Eiswaffelspender, drehbar, Plexiglas
Porte-cornets pivotant, plexiglas
Distributor giratorio de cucuruchos, plexiglas

7art.	ø cm.	h.	ø int.
41472-15	24	78	5,4



Porta coni, apertura frontale, plexiglas
Cone holder, front opening, plexiglas
Eiswaffelspender, Plexiglas
Porte cornets à glace, ouverture frontale
Porta cucuruchos, plexiglas

art.	dim. cm.	h.	ø int.
41472-16	11x13	50	5,2



Porta coppette, plexiglas
Bowls holder, plexiglas
Schalenspender, Plexiglas
Porte pots à glace, plexiglas
Soporte para bols, plexiglas

art.	dim. cm.	h.	int.
41472-11	11x11	35	9x9



Bicchierino, monouso
Small glass, disposable
Klein Glass
Petite verre
Bol pequeño

art.	Ø cm.	h.	ml.	u.pack
48353-01	8,5	6,5	120	100



Bicchierino, monouso
Small glass, disposable
Klein Glass
Petite verre
Bol pequeño

art.	Ø cm.	h.	ml.	u.pack
48354-01	4	8,5	70	100





Bicchierino, monouso
Small glass, disposable
Klein Glass
Petite verre
Bol pequeño

art.	Ø cm.	h.	ml.	u.pack
48350-01	4,2	6,5	50	100
48350-02	5,0	6,5	80	100
48350-03	5,5	7,0	100	100
48350-04	6,0	9,0	160	100

Bicchierino, monouso
Small glass, disposable
Klein Glass
Petite verre
Bol pequeño

art.	cm.	h.	ml.	u.pack
48351-01	4x4	5,5	50	100
48351-02	5x5	7,0	100	100
48351-03	5,5x5,5	8,0	150	100

Bicchierino, monouso
Small glass, disposable
Klein Glass
Petite verre
Bol pequeño

art.	Ø cm.	h.	ml.	u.pack
48352-01	6,5	5,5	70	100
48352-02	7,0	6,7	120	100
48352-03	7,5	7,3	150	100



Coppetta, monouso
Cup, disposable
Schale, einweg
Bol, jetable
Bol, desechable

art.	Ø cm.	h.	ml.	u.pack
48365-09	9	7,5	175	100

Coppetta, monouso
Cup, disposable
Schale, einweg
Bol, jetable
Bol, desechable

art.	Ø cm.	h.	ml.	u.pack
48366-09	9	7,5	125	100



Bacinella per gelato, inox
Ice cream container, stainless steel
Eisbehälter, Edelstahl Rostfrei
Réceptient à glace, inox
Cubeta helado, inox

art.	dim. cm.	h.	lt.
41471-12	36x16,5	12	5,0
41471-15	36x16,5	15	6,5
41471-17	36x16,5	17	7,5

Coperchio per bacinella gelato, plexiglas
Lid for ice cream container, plexiglas
Deckel für Eisbehälter, Plexiglas
Couvercle pour réceptient à glace, plexiglas
Tapa para cubeta helado, plexiglas

art.	dim. cm.
41471-00	36x16,5

Bacinella per gelato, inox
Ice cream container, stainless steel
Eisbehälter, Edelstahl Rostfrei
Réceptient à glace, inox
Cubeta helado, inox

art.	dim. cm.	h.	lt.
41486-08	36x25	8	5
41486-12	36x25	12	8
41486-15	36x25	15	10

BAR HAPPY HOUR BUFFET



Bacinella per gelato, inox
Ice cream container, stainless steel
Eisbehälter, Edelstahl Rostfrei
Récipient à glace, inox
Cubeta helado, inox

art.	dim. cm.	h.	lt.
41487-12	26x16	12	3,5
41487-15	26x16	15	4,1
41487-17	26x16	17	4,5



Spatola gelato, inox
Ice cream server, stainless steel
Eispachtel, Edelstahl Rostfrei
Palette à glace, inox
Paleta helados, inox

art.	l. cm.
41475-00 ○	27
41475-01 ●	27
41475-03 ●	27
41475-04 ●	27
41475-05 ●	27



Spatola gelato
Ice-dipper
Eisdipper
Cuillère à glace
Cuchara helados

art.	Ø mm.	lt.
41468-20	55	1/20 aluminum
41468-24	50	1/24 aluminum

Con liquido conduttore nel manico.
With liquid heat conductor in the handle.



Spatola gelato
Ice-dipper
Eisdipper
Cuillère à glace
Cuchara helados

art.	Ø mm.	lt.	
41469-20	55	1/20	teflon
41469-24	50	1/24	teflon

Con liquido conduttore nel manico.
With liquid heat conductor in the handle.



Porzionatore, inox
Ice cream scoop, stainless steel
Eisportionierer, Edelstahl Rostfrei
Cuillère à glace, inox
Racionador de helado, inox

art.	Ø mm.	lt.
41476-50	50	1/24

Manico antiscivolo. - Non slip handle.



Porzionatore, inox
Ice cream scoop, stainless steel
Eisportionierer, Edelstahl Rostfrei
Cuillère à glace, inox
Racionador de helado, inox

art.	Ø mm.	lt.
41473-31	30	1/100
41473-39	38	1/65
41473-44	43	1/50
41473-50	50	1/24
41473-56	55	1/20
41473-62	60	1/14
41473-66	66	1/12



Porzionatore ovale, inox
Oval ice cream scoop, stainless steel
Eisportionierer, oval, Edelstahl Rostfrei
Cuillère à glace ovale, inox
Racionador de helado, inox

art.	Ø mm.	lt.
41474-00	60	1/30



Porzionatore triangolare, inox
Triangle ice cream scoop, s/s
Eisportionierer, dreieckig, Edelstahl
Cuillère à glace, triangle, inox
Racionador de helado, inox

art.	lt.
41474-02	1/30



Ricariche panna montata, conf. 10 pezzi
Cream chargers, 10-pcs set
10-Stk. Sahnekapseln-Packung
Capsules à crème Chantilly, set 10 pièces
Cápsulas para nata, 10 piezas

art.
41450-AA
Contiene N20 sotto pressione.
Contains N20 under pressure.



Sifone panna, inox
Professional cream whipper, stainless steel
Profi-Sahnebereiter, 18-10 Edelstahl
Siphon à crème professionnel, inox
Sifón montador de nata profesional, inox

art.	lt.
41451-05	0,5
41451-10	1,0

KAYSER



Stecchi, legno
Wood sticks
Holz-Stiele
Bâtons en bois
Palos de madera

art.	pz/pcs
41466-49	50

N



Espositori in plexiglass
Plexiglass displays
Deckel für Eisbehälter, Plexiglas
Couvercle pour récipient à glace, plexiglas
Tapa para cubeta helado, plexiglas

art.	dim. cm.	h.	pz/pcs
41466-43	16,5x36	5	16-24
41466-44	24,5x36	5	24-40

N



Stampo gelato
Ice cream mold
Eis-Ausstechforme
Moule à glace
Molde para helado

Stampo gelato
Ice cream mold
Eis-Ausstechforme
Moule à glace
Molde para helado

Stampo gelato
Ice cream mold
Eis-Ausstechforme
Moule à glace
Molde para helado

art. int. dim. mm ml. pz/pcs
41466-01 93x48,5x25 90 12

art. int. dim. mm ml. pz/pcs
41466-02 93x48,5x25 90 12

art. int. dim. mm ml. pz/pcs
41466-03 93x48,5x25 90 8

Set 2 stampi + vassoio 295x395 mm + 50 stecchi legno. - Set 2 molds + tray 295x395 mm + 50 wooden sticks.



Stampo ghiacciolo, plastica
Ice lolly mold, plastic
Eiscreme Form, Kunststoff
Moule sucettes glacées, plastique
Molde helados, plástico

Stampo ghiacciolo, plastica
Ice lolly mold, plastic
Eiscreme Form, Kunststoff
Moule sucettes glacées, plastique
Molde helados, plástico

Stampo ghiacciolo, plastica
Ice lolly mold, plastic
Eiscreme Form, Kunststoff
Moule sucettes glacées, plastique
Molde helados, plástico

art. gr. pz/pcs
41466-21 80-85 24

art. gr. pz/pcs
41466-22 80-85 24

art. gr. pz/pcs
41466-23 80-85 24



Stampo ghiacciolo, plastica
Ice lolly mold, plastic
Eiscreme Form, Kunststoff
Moule sucettes glacées, plastique
Molde helados, plástico

Stampo semifreddo, plastica
Semifreddo mold, plastic
Semifreddo Form, Kunststoff
Moule semifreddo, plastique
Molde semifreddo, plástico

Stampo semifreddo, plastica
Semifreddo mold, plastic
Semifreddo Form, Kunststoff
Moule semifreddo, plastique
Molde semifreddo, plástico

art. gr. pz/pcs
41466-24 80-85 24

art. dim. cm. int. dim. mm pz/pcs
41466-31 39x13,5x2 70x85x20 5

art. dim. cm. int. dim. mm pz/pcs
41466-32 39x11,5x2 ø70x20 5



Stampo semifreddo, plastica
Semifreddo mold, plastic
Semifreddo Form, Kunststoff
Moule semifreddo, plastique
Molde semifreddo, plástico

Stampo semifreddo, plastica
Semifreddo mold, plastic
Semifreddo Form, Kunststoff
Moule semifreddo, plastique
Molde semifreddo, plástico

Stampo semifreddo, plastica
Semifreddo mold, plastic
Semifreddo Form, Kunststoff
Moule semifreddo, plastique
Molde semifreddo, plástico

art. dim. cm. int. dim. mm pz/pcs
41466-33 39x14,5x2 95x40x20 6

art. dim. cm. int. dim. mm pz/pcs
41466-34 39x11,5x2 70x70x20 5

art. dim. cm. int. dim. mm pz/pcs
41466-35 39x11,5x2 70x70x20 5



Sifone panna, GOURMET WHIP, inox
 Cream whipper, stainless steel
 Sahnebereiter, Edelstahl Rostfrei
 Siphon à crème, inox
 Sifón para nata montada, inox



art.	lt.
41458-02	0,25
41458-05	0,50
41458-10	1,00

Guarnizione in silicone resistente al calore. Tenere a bagnomaria max. a 75°C. Dotato di 3 bocchette inox, lancia, tulipano, stella e scovolino. Lavabile in lavastoviglie. - Heat resistant silicone gasket. Keep warm in bain marie up to 75°C. Inclusive s/s straight tip, tulip tip, star tip, cleaning brush. Dishwasher-safe.



Sifone termico, THERMO WHIP, inox
 Thermo whipper, stainless steel
 Thermo-Sahnebereiter, Edelstahl Rostfrei
 Siphon à crème, isotherme, inox
 Sifón isotérmico, inox



art.	lt.
41455T55	0,50

Bottiglia termica a doppia parete. Mantiene le preparazioni in caldo fino a 3 ore e a freddo fino a 8 ore. Dotato di 3 bocchette inox, lancia, tulipano, stella e scovolino. Lavabile in lavastoviglie. - Double-walled, vacuum-insulated bottle: keeps creations cold for 8 hours and hot for 3 hours. Inclusive stainless steel straight tip, tulip tip, star tip, cleaning brush. Dishwasher-safe.



Sifone termico, THERMO XPRESS WHIP, inox
 Thermo whipper, stainless steel
 Thermo-Sahnebereiter, Edelstahl Rostfrei
 Siphon à crème, isotherme, inox
 Sifón isotérmico, inox



art.	lt.	h. cm.
41459-10	1,00	35

Bottiglia termica, mantiene le preparazioni in caldo fino a 3 ore e a freddo fino a 8 ore, lavabile in lavastoviglie. - Double-walled, insulated bottle: keeps creations cold for 8 hours and hot for 3 hours, dishwasher-safe.

Sifone panna, CREAM PROFI WHIP, inox
 Cream whipper Edelstahl Rostfrei
 Sahnebereiter Edelstahl Rostfrei
 Siphon à crème, inox
 Sifón para preparación de nata montada, inox



art.	lt.
41460-05	0,50
41460-10	1,00

Solo per preparazioni fredde. Dotazione 1 beccuccio a lancia e 1 beccuccio a tulipano e scovolino. Lavabile in lavastoviglie. - Only for cold preparations. Inclusive s/s straight tip, tulip tip, cleaning brush. Dishwasher-safe.



Ricariche panna montata
 Cream chargers
 Sahnekapseln-Packung
 Capsules à crème Chantilly
 Cápsulas para nata

art.	pz/pcs
41455-AA	10
41455-AB	50

Contenuto: 8 g di N2O (E942 protossido di azoto).
 Filled with 8 g of N2O (E942, nitrous oxide).



Bocchette, set 3 pezzi
 Decorating tips, 3-pcs set
 Dekorationstüllen, 3er Set
 Douilles de décoration, 3 pièces
 Boquillas de decoración, 3 piezas

art.
41455-BC

1 bocchetta tulipano, 1 stella, 1 lancia. - 1 Tulip Tip, 1 Star Tip, 1 Straight Tip.

isi



Imbuto e colino, inox
Funnel & sieve, stainless steel
Trichter & Sieb, Edelstahl Rostfrei
Entonnoir, inox
Embudo & tamiz, inox

art.
41458-11



Bocchette decoro e adattatore
Decorating tips and adapter
Dekorationstüllen-Set u. Adapter
Douilles de décoration et adaptateur
Boquillas de decoración y adaptador

art.
41458-24
1 bocchetta petalo, 1 quadrata, 1 rosa, 1 adattatore. - 1 petal piping tip, 1 square tip, 1 rose tip, 1 adapter.



Bocchette inox
Decorating tips, stainless steel
Dekorationstüllen-Set, Edelstahl Rostfrei
Douilles de décoration, inox
Boquillas de decoración, inox

art.
41458-23
1 bocchetta tulipano, 1 stella, 1 liscia.
1 tulip tip, 1 tar tip, 1 straight tip.



Iniettori/siringhe decoro, inox
Injector needles, stainless steel
Nadeltüllen, Edelstahl Rostfrei
Aiguilles d'injection, inox
Boquillas de aguja, inox

art.
41458-21
2 iniettori lunghi e 2 corti Ø 3-5 mm, 4 cappucci protettivi. Per decorare, iniettare liquidi, marinare, irrorare, e bagni di calcio. - 2 long & 2 short Injector tips Ø 3-5 mm, 4 protective covers. Ideal for decoration, stuffing food, liquid injections, marinating, injecting and basting, frying and fat cooking, water and calcium bath.



Ricariche panna montata, PROFESSIONAL
Cream chargers, PROFESSIONAL
Sahnekapseln-Packung, PROFESSIONAL
Capsules à crème Chantilly, PROFESSIONAL
Cápsulas para nata, PROFESSIONAL

art. pz/pcs
41455-CA 20
41455-CB 42

N



Protezione in silicone
Heat protector, silicone
Silikonhülle
Housse en silicone
Protección de silicona

art. lt.
41458-50 0,50
41458-51 1,00



Kit di infusione rapida
Kit rapid infusion
Rapid Infusion Set
Paquet rapid infusion
Rapid infusion set

art.
41458-25
Incl.: guarnizione per setaccio in silicone, setaccio inox, tubo di ventilazione inox, tubo di silicone, scovolino. - Contains: sieve gasket 100% silicone, stainless steel internal sieve, s/s ventilation tube, silicone tube, cleaning brush.



Il kit di infusione rapida permette di infondere un liquido con sapori diversi in tempo rapido. Unire gli aromi solidi (erbe, spezie, frutta, ecc.) con il liquido (alcol, olio, acqua, aceto, ecc.) nel sifone ed immettere una carica per panna (art. 41455-AA). Il sapore degli aromi solidi viene infuso nel liquido, che sviluppa così un gusto unico. - Rapid Infusion enables a liquid to be infused with different flavors in the shortest possible time. First, combine aromatic solids (e.g. herbs, spices, fruit) and a liquid (e.g. alcohol, oil, water, vinegar) in the Whipper. By applying pressure into the Whipper using a cream charger (#41455-AA), the flavor of the solids becomes infused into the liquid, which develops a unique taste.



Sifone soda
Soda siphon
Soda Siphon
Siphon à eau de seltz
Sifón agua de seltz

art.	lt.
41453-07	0,75
41453-11	1,00



Per la preparazione di acqua gassata, bibite e cocktail effervescenti. Bottiglia in acciaio inox di alta qualità. Valvola di regolazione della pressione per il massimo comfort e sicurezza. Impugnatura antiscivolo in silicone.
For the preparation of pure soda water, sparkling refreshments & cocktails. High-quality stainless steel bottle. Pressure control valve for maximum comfort and safety. Ergonomic charger holder with non-slip silicone grip.



Sifone soda
Soda siphon
Soda Siphon
Siphon à eau de seltz
Sifón agua de seltz

art.	lt.
41465-10	1,00

N



N

Sifone soda
Soda siphon
Soda Siphon
Siphon à eau de seltz
Sifón agua de seltz

art.	lt.
41454-01	1,00



N

2 Bottiglie Twist & Sparkle
2 Bottles Twist & Sparkle
2 Flaschen Twist & Sparkle
2 Bouteilles Twist & Sparkle
2 Bottiglie Twist & Sparkle

art.	lt.
41454-99	1,00



Ricariche soda, conf. 10 pezzi
Soda chargers, 10-pcs set
10-Stk. Sodakapseln-Packung
Capsules à eau de seltz, set 10 pcs
Cápsulas para agua de seltz, 10 pz

art.
41453-AA
Contenuto: 8 gr di CO2.
Content: 8 g of CO2.



Scatola portabustine thè, acrilico
Tea-box, acrylic
Teebox, Acryl
Boîte à sachets de thé, acrilique
Caja para bolsitas de té, acrílico

art.	dim. cm.	h.
41614-22	22x17	9



Scatola portabustine thè, legno
Tea-box, wood
Teebox, Holz
Boîte à sachets de thé, bois
Caja para bolsitas de té, madera

art.	dim. cm.	h.
41614-33	33,5x20	9
41614-35	31x28	9



Scatola portabustine thè, legno
Tea-box, wood
Teebox, Holz
Boîte à sachets de thé, bois
Caja para bolsitas de té, madera

art.	dim. cm.	h.
41614-34	33,5x20	9
41614-36	31x28	9



Kit 10 mascherine, plastica
Set of 10 stencils, plastic
Satz 10 Masken, kunststoff
Set 10 pcs masques, plastique
Juego 10 máscaras, plástico

art.	ø cm.
47859-01	10



Kit 10 mascherine, plastica
Set of 10 stencils, plastic
Satz 10 Masken, kunststoff
Set 10 pcs masques, plastique
Juego 10 máscaras, plástico

art.	ø cm.
47859-02	10



Kit 4 mascherine, plastica
Set of 4 stencils, plastic
Satz 4 Masken, kunststoff
Set 4 pcs masques, plastique
Juego 4 máscaras, plástico

art.	ø cm.
47859-03	10



Kit spargicacao & 7 mascherine, inox
Cocoa duster with 7 discs, stainless steel
Kakaostreuer mit 7 Masken, Edelstahl
Glacière à cacao & 7 masques, inox
Dosificador cacao con 7 máscaras, inox

art.	ø cm.	h.
42923-07	6,5	13

Spargicacao, inox
Cocoa dredger, stainless steel
Kakaostreuer, Edelstahl Rostfrei
Saupoudreuses, inox
Especiero, inox

art.	ø cm.	h.	ml.
41607-00	5,5	7,5	160
Fori/Holes: Ø 1,5 mm.			

Spargizucchero, inox
Dredger, stainless steel
Zuckerstreuer, Edelstahl Rostfrei
Saupoudreuses, inox
Especiero, inox

P

art.	ø cm.	h.	ml.	mm.
47023-01	7	8,5	300	1,5
47023-02	7	8,5	300	2,5
47023-03	7	8,5	300	5,0
47023-04	7	8,5	300	mesh



Spargizucchero
Sugar pourer
Zuckerstreuer
Sucrier
Dispensador azúcar

art.	ø cm.	h.	ml.
41525-01	8,4	15,5	150

Spargizucchero, vetro e inox
Sugar pourer, glass and stainless steel
Zuckerstreuer, Glas u. Edelstahl Rostfrei
Sucrier, verre et inox
Azucarero, vidrio y inox

art.	ml.
42920-02	360

Spargizucchero, dosatore
Sugar pourer
Zuckerstreuer
Sucrier doseur
Azucarero dosificador

art.	ml.
41645-00	360



Dosatore miele, cremiera
Honey/cream dispenser
Sahnekännchen
Doseur pour miel/lait
Dosificador para miel/leche

art.	ø cm.	h.	ml.
41525-00	8,5	13,5	150

Lattiera/teiera
Milk pot/tea pot
Milchgießer/Teekanne
Pot à lait/théière
Jarra leche/tetera

art.	lt.
66303-01	0,15
66303-03	0,30
66303-06	0,60

Lattiera cappuccino
Cappuccino milk pot
Cappuccino-Milchkanne
Pot à cappuccino
Jarra cappuccino

art.	lt.
66307-06	0,60
66307-09	0,90
66307-12	1,20



N



Portabustine zucchero, inox
Sugar packet holder, stainless steel
Zuckertütenschale, Edelstahl Rostfrei
Conteneur à sucre, inox
Contenedor sobres azúcar, inox

art.	dim. cm.	h.
66374-00	13x6	4

Porta bustine zucchero/tè, inox
Sugar/tea packet holder, s/s
Tee/Zuckerpäckchen-Halter, Edelstahl R.
Porte-sachet de sucre/thé, inox
Contenedor sobres azúcar/té, inox

art.	dim. cm.	h.
44104-15	9x7,5	5

Porta bustine zucchero/tè
Sugar/tea packet holder
Tee/Zuckerpäckchen-Halter
Porte-sachet de sucre/thé
Contenedor sobres azúcar/té

art.	dim. cm.	h.
67303-64	11x6	4

Porcellana. - Porcelain.



Portabustine zucchero
Sugar packet holder
Zuckertütenschale
Conteneur à sucre
Contenedor sobres azúcar

art.	dim. cm.	h.
44104-01	8,5x6,5	5



Portabustine zucchero
Sugar packet holder
Zuckertütenschale
Conteneur à sucre
Contenedor sobres azúcar

art.	dim. cm.	h.
44104-02	8,5x6,5	5



Portatovaglioli, inox
Napkin holder, stainless steel
Serviettenhalter, Edelstahl Rostfrei
Porte serviettes, inox
Servilletero, inox

art.	dim. cm.	h.
66391-00	10x3	8



Portatovaglioli, inox
Napkin holder, stainless steel
Serviettenhalter, Edelstahl Rostfrei
Porte serviettes, inox
Servilletero, inox

art.	dim. cm.	h.
41602-00	17x3	7

N



Portatovaglioli, inox
Napkin dispenser, stainless steel
Serviettenspender, Edelstahl Rostfrei
Conteneur pour serviettes, inox
Servilletero, inox

art.	dim. cm.	h.
41601-17	8,5x11	12,5

P



Portatovaglioli in filo cromato
Napkin holder, chrome plated wire
Serviettenhalter, Metall verchromt
Porte-serviettes en fil chromé
Servilletero en hilo cromado

art.	dim. cm.	h.
41617-05	19x19	6,5



Portatovaglioli in filo cromato
Napkin holder, chrome plated wire
Serviettenhalter, Metall verchromt
Porte-serviettes en fil chromé
Servilletero en hilo cromado

art.	dim. cm.	h.
41617-15	19x19	19,0



Portatovaglioli in filo cromato
Napkin holder, chrome plated wire
Serviettenhalter, Metall verchromt
Porte-serviettes en fil chromé
Servilletero en hilo cromado

art.	dim. cm.	h.
41618-14	14x14	6,5



Vassoio quadrato, inox
Tray, square, stainless steel
Serviertablett, quadratisch, Edelstahl
Plateau carré, inox
Bandeja cuadra, inox

art.	dim. cm.	h.
41625-23	23x23	1,5



Vassoio conto, inox 18 Cr
Cash tray, 18 Cr stainless steel
Rechnungstablett, Edelstahl 18 Cr
Plateau porte-monnaie, inox 18 Cr
Bandeja cuentas, acero 18 Cr

art.	dim. cm.
66318-19	19x14
66318-22	22x15



Alzata dolci, 2 piani, cromata
Pastry stand, 2 tiers, chrome plated
Gebäckständer, 2-stufig, verchromt
Serveur muet, 2 étages, chromé
Soporte dulces, 2 niveles, cromado

art.	ø cm.	h.
42975-02	11-14	16



Cestino agrumi, inox
Fruit basket, stainless steel
Obstkorb, Edelstahl Rostfrei
Panier à fruits, inox
Cesta frutas, inox

art.	Ø cm.	h.
41611-20	21,5	20



Espositore porta frutta
Fruit stand
Obstspender
Etagère à fruits
Expositor frutas

art.	Ø cm.	h.
41449-27	27,5	32



Espositore porta frutta
Fruit stand
Obstspender
Etagère à fruits
Expositor frutas

art.	Ø cm.	h.
41449-32	32,0	53

Supporto in filo cromato, ciotola estraibile in acciaio inox.
Chrome plated wire stand with removable stainless steel bowl.



Spremiagrumi manuale, prof., cromato
Professional orange juicer, chromed
Profi-Orangenpresse, verchromt
Presse-agrumes, professionnel, chromé
Exprimidor de cítricos, prof., cromado

art.	dim. cm.	h.	Ø
41456-00	19x18	56	10



Spremiagrumi manuale, cromato
Orange juicer, chromed
Orangenpresse, verchromt
Presse-agrumes, chromé
Exprimidor de cítricos, cromado

art.	dim. cm.	h.	Ø
41456-02	18x13	46	10



P

Spremilimone, inox
Lemon squeezer, stainless steel
Zitronenpresse, Edelstahl Rostfrei
Presse citron, inox
Exprime limones, inox

art.	dim. cm.
41606-00	12,5x6,5



P

Spremilimone, inox
Lemon squeezer, stainless steel
Zitronenpresse, Edelstahl Rostfrei
Presse citron, inox
Exprime limones, inox

art.	dim. cm.
41606-01	7x8,5



P

Spremilimone, alluminio
Lemon squeezer, aluminum
Zitronenpresse, aluminum
Presse citron, alu
Exprime limones, aluminio

art.	l. cm.
41606-02	20

BAR HAPPY HOUR BUFFET



Rompighiaccio
Ice pick
Eisstößel
Casse-glace
Pick hielo

art.
44105-00



Pestaghiaccio, plastica
Ice beater, plastic
Eiszerstosser, Kunststoff
Pic à glace, plastique
Pico para hielo, plástico

art. ø cm. l.
41503-22 2,5 22,5



Tritaghiaccio, cromato
Chromed ice crusher
Eiswolf, verchromt
Broyer à glace, chromé
Trituradora de hielo, cromada

art. dim. cm. h.
41457-00 15x12 26

P



Sessola per ghiaccio, inox
Ice scoop, stainless steel
Eisschaufel, Edelstahl Rostfrei
Pelle à glace, inox
Librador para hielo, inox

art. ml.
41503-00 100



Sessola per ghiaccio, PC
Ice cubes scoop, PC
Eisschaufel, PC
Pelle à glaçons, PC
Librador para hielo, PC

art. ml.
14958-01 100
14958-02 250



Cucchiaio ghiaccio, inox
Ice spoon, stainless steel
Eislöffel, Edelstahl Rostfrei
Cuillère à glace, inox
Cuchara hielo, inox

art. l. cm.
52550-04 22

P



Stampo per sfere di ghiaccio, PP
Mold for ice-balls, PP
Eis-Kugel-Former, PP
Moule pour boules de glace, PP
Molde de cubitos de hielo esféricos, PP

art. dim. cm. h.
41515-03 23,5x8,5 6,5

Per 3 sfere ø 5,5 cm da 100 ml.
For 3 balls ø 5,5 cm, 100 ml.



P

Secchio ghiaccio con molla
Ice bucket with tong
Eiseimer mit Eiszange
Seau à glace avec pince
Cubo hielo con pinza

art. ø cm. h. lt.
41513-13 14 22 1,3

Camicia in materiale plastico, finitura cromata lucida con speciale inserto termico. - Noble plastic jacket highly chrome plated with special insulated plastic insert.



Secchio ghiaccio, plastica
Ice bucket, plastic
Eiseimer, Kunststoff
Seau à glace, plastique
Cubo hielo, plástico

art. ø cm. h. lt.
41512-15 15 15 1,5
41512-30 20 18 3,0

Finitura effetto metallo satinato, bordo lucido. Speciale inserto termico. - Satin metal look with highly polished edge. Special insulated plastic insert.



Secchio ghiaccio, PP-SAN
Ice box
Eisbox
Seau à glaçons
Cubitera

art. dim. cm. h. lt.
41512-50 27x27 15 5,4

Con griglia. - With drainer.



Secchio ghiaccio, inox
Ice bucket, stainless steel
Eisbehälter, Edelstahl Rostfrei
Seau à glace, inox
Cubitera hielo, inox

art.	Ø cm.	h.
56116-15	12,5	13



Porta oggetti da bar
Bar organizer
Bar-Behälter
Présentoir de bar
Dispensador bar

art.	dim. cm.	h.
44102-24	24x14,5	11



Porta cannucce, inox
Straw holder, stainless steel
Röhrchenbehälter, Edelstahl Rostfrei
Porte chalumeaux, inox
Porta canutillos, inox

art.	Ø cm.	h.
66313-06	8	12



Porta cucchiaini, inox
Spoon holder, stainless steel
Kaffeelöffelbehälter, Edelstahl Rostfrei
Porte cuillères, inox
Porta cucharas, inox

art.	Ø cm.	h.
66313-03	6	9



Set da bar, 5 pezzi, inox
Bar set, 5 pieces, stainless steel
Bar-Set, 5-tlg., Edelstahl Rostfrei
Set 5 pièces à cocktail, inox
Juego 5 piezas cóctel, inox

art.
41510-05



Colino cocktail, inox
Cocktail strainer, stainless steel
Cocktail-Sieb, Edelstahl Rostfrei
Passoire à cocktail, inox
Colador cóctel, inox

art.	Ø cm.	l.
41603-00	9	17



Colino Julep, inox
Julep strainer, stainless steel
Julep Barsieb, Edelstahl
Tamis cocktail Julep, inox
Colador de cóctel, inox

art.	Ø cm.	l.
41603-07	7,5	18



Colino Julep, inox
Julep strainer, stainless steel
Julep Barsieb, Edelstahl
Tamis cocktail Julep, inox
Colador de cóctel, inox

art.	Ø cm.	l.
41603-08	8	15,5



Cucchiaio magico, inox
Magic spoon whisks, stainless steel
Zauberlöffel, Edelstahl Rostfrei
Fouet plat à spirales inox
Cuchara mágica, inox

art.	l. cm.
41595-20	20



Cucchiaio miscelatore, inox
Cocktail spoon, stainless steel
Cocktail-Löffel, Edelstahl Rostfrei
Cuillère à cocktail, inox
Cuchara cóctel, inox

art.	l. cm.
41605-00	27



Cucchiaio bar, inox/rame
Bar spoon, s/steel/copper
Bar-Löffel, Edelstahl/Kupfer
Cuillère à cocktail, inox/cuivre
Cucharilla de cóctel, inox/cobre

art.	l. cm.
41605-01	27



Cucchiaio/forchetta bar, inox
Bar spoon/fork, stainless steel
Bar-Löffel/-Gabel, Edelstahl Rostfrei
Cuillère/fourchette à cocktail, inox
Cucharilla/tenedor de cóctel, inox

art.	l. cm.
41605-03	50

BAR HAPPY HOUR BUFFET



P

Cucchiaio bibita, inox
Ice tea spoon, stainless steel
Limonadenlöffel, Edelstahl Rostfrei
Cuillère à soda, inox
Cuchara refresco, inox

art.	l. cm.	u. pack
41605-25	25	6



P

Pinza, inox
Cooking tong, stainless steel
Kochzange, Edelstahl Rostfrei
Pince, inox
Pinza, inox

art.	l. cm.
42902-30	30



Pinza, inox
Cooking tong, stainless steel
Kochzange, Edelstahl Rostfrei
Pince, inox
Pinza, inox

art.	Ø cm.	h.	ml.
41604-00	3,5-4	7	30/10



Misurino cocktail, inox
Cocktail measuring cup, stainless steel
Alkohol-Meßbecher, Edelstahl Rostfrei
Mesureur de cocktail, inox
Medidor de cóctel, inox

art.	Ø cm.	h.	ml.
41604-00	3,5-4	7	30/10



N

Misurino cocktail, inox
Japanese jigger, stainless steel
Cocktail-Doppelmaß, Edelstahl Rostfrei
Mesure double jigger, inox
Medidor, inox

art.	Ø cm.	h.	ml.
41604-01	4	11	25/50



N



Misurino cocktail
Japanese jigger
Cocktail-Doppelmaß
Mesure double jigger
Medidor

art.	Ø cm.	h.	ml.
41604-02	4	11	25/50



P

Shaker, inox
Long-drink shaker, stainless steel
Shaker, Edelstahl Rostfrei
Shaker, inox
Coctelera, inox

art.	ml.
41480-03	200
41480-05	500
41480-07	700



N



Shaker, inox/rame
Shaker, stainless steel/copper
Shaker, Edelshtal/Kupfer
Shaker, inox/cuivre
Coctelera, inox/cobre

art.	Ø cm.	h.	ml.
41482-05	8,5	20	500
41482-07	9,0	23	700



N

Shaker Parisian, inox satinato
Shaker Parisian, satin polished s/s
Shaker, Edelshtal mattiert
Shaker, inox satin
Coctelera, inox satinado

art.	Ø cm.	h.	ml.
41461-07	9,5	24	700



P

Shaker, inox-SAN
Cocktail shaker, s/s-SAN
Shaker, Edelstahl-SAN
Shaker, inox-SAN
Coctelera, inox/SAN

art.	ml.	col.
41481-02	550	●
41481-03	550	●



P

Shaker, acrilico
Shaker, acrylic
Shaker, Kunststoff
Shaker, acrylique
Coctelera, acrilico

art.	ml.
41483-04	420
41483-06	660





Agitatore Boston, rivestimento vinile
Boston shaker, vinyl coated
Boston-Shaker, Vinyl Überzug
Shaker Boston, revêtement en vinyle
Coctelera Boston, revestimiento vinilo

art.	ø cm.	h.	ml.	col.
41479-11	9	18	830	●
41479-12	9	18	830	●
41479-13	9	18	830	●
41479-14	9	18	830	●
41479-15	9	18	830	○



Cono Boston con fondello, inox
Boston cone, stainless steel
Boston Shaker, Edelstahl Rostfrei
Boston cône, inox
Coctelera Boston, inox

art.	ø cm.	h.	ml.
41479-05	9,2	17,2	500



Shaker Boston, inox/rame
Boston shaker, stainless steel/copper
Boston shaker, Edelstahl/Kupfer
Shaker Boston, inox/cuivre
Coctelera Boston, inox/cobre

art.	ø cm.	h.	ml.
41462-07	9	30	700/400

Con bicchiere. - With glass.



Bicchiere vetro
Mixing glass
Becherglas
Verre
Vaso vidrio

art.	ø cm.	h.	ml.
41479-AA	8,5	15	500



Bicchiere vetro
Mixing glass
Becherglas
Verre
Vaso vidrio

art.	ø cm.	h.	ml.
41478-50	8,8	15	473
41478-35	8,3	13	355



Bicchiere vetro
Mixing glass
Becherglas
Verre
Vaso vidrio

art.	ø cm.	h.	ml.
41477-50	9	15	473

Graduato in once. - With ounce markings.



Bicchiere miscelatore con becco versatore
Mixing glass with lip
Rührglas mit Lippe
Verre mélangeur avec bec verseur
Vaso mezclador vertedor con pico

art.	ø cm.	h.	lt.
41514-05	9	16,5	0,5



Bicchiere miscelatore con becco versatore
Mixing glass with lip
Rührglas mit Lippe
Verre mélangeur avec bec verseur
Vaso mezclador vertedor con pico

art.	ø cm.	h.	lt.
41514-10	11,5	19	0,95



Flair bottle
Flair bottle
Flair bottle
Flair bottle
Flair bottle

art.	lt.	col.
44108-01	0,75	○
44108-02	0,75	●



Manico inox
Stainless steel handle



Tazza Moscow Mule, inox/rame
Moscow Mule mug, stainless steel/copper
Becher Moscow Mule, Edelshtal/Kupfer
Gobelet Moscow Mule, inox/cuivre
Taza Moscow Mule, inox/cobre

art.	ø cm.	h.	ml.
41463-01	9	9,0	500



Manico dorato
Gold plated handle



Tazza Moscow Mule, inox/rame
Moscow Mule mug, stainless steel/copper
Becher Moscow Mule, Edelshtal/Kupfer
Gobelet Moscow Mule, inox/cuivre
Taza Moscow Mule, inox/cobre

art.	ø cm.	h.	ml.
41463-02	9	9,5	550

BAR HAPPY HOUR BUFFET



Bottiglietta vetro
Dash bottle, glass
Dash Bottle aus Glas
Dash bottle, verre
Dash bottle, vidrio

art.	ml.
41681-01	100



Bottiglietta vetro
Dash bottle, glass
Dash Bottle aus Glas
Dash bottle, verre
Dash bottle, vidrio

art.	ml.
41681-02	200



Bottiglietta vetro
Dash bottle, glass
Dash Bottle aus Glas
Dash bottle, verre
Dash bottle, vidrio

art.	ml.
41681-03	330

Senza dosatore. - Without pourer.



Bottiglietta vetro
Dash bottle, glass
Dash Bottle aus Glas
Dash bottle, verre
Dash bottle, vidrio

art.	ml.
41681-04	100

Senza dosatore. - Without pourer.



Tappo dosatore
Dash bottle pourer
Ausgiesser
Bouchon verseur
Tapón vertedor

art.
41681-99

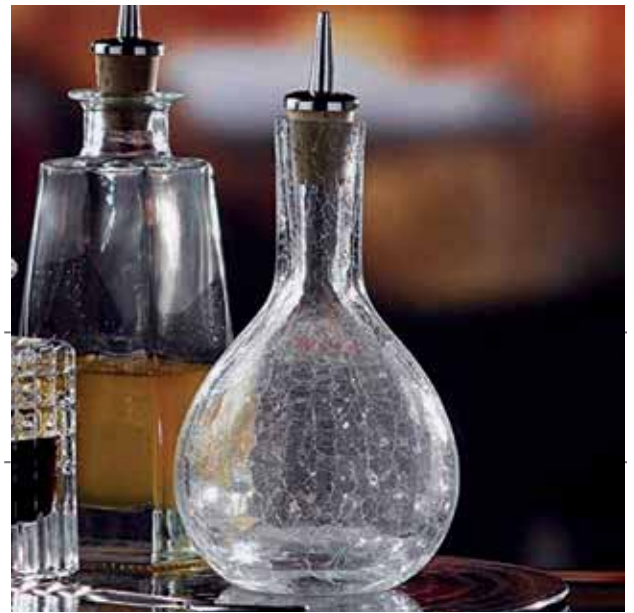

Contenitore versatore
Pouring container
Dosier-Vorratsbehälter, komplett
Bouteille verseuse
Recipiente vertedor

art.		ø cm.	h.	lt.
44106W05	44106G05	9,0	26	0,5
44106W10	44106G10	9,0	33	1,0
44106W20	44106G20	12,5	35	2,0
44106W25	44106G25	12,5	39	2,5
W= BIANCO/WHITE G= VERDE/GREEN				
44106Y05	44106R05	9,0	26	0,5
44106Y10	44106R10	9,0	33	1,0
44106Y20	44106R20	12,5	35	2,0
44106Y25	44106R25	12,5	39	2,5
Y= GIALLO/YELLOW R= ROSSO/RED				
44106O05	44106B05	9,0	26	0,5
44106O10	44106B10	9,0	33	1,0
44106O20	44106B20	12,5	35	2,0
44106O25	44106B25	12,5	39	2,5

O= ARANCIONE/ORANGE B= MARRONE/BROWN



Contenitore di riserva
Storage canister
Vorratsbehälter, komplett
Réipient réserve
Recipiente reserva

art.		ø cm.	h.	lt.
44107W05	44107G05	9,0	9,5	0,5
44107W10	44107G10	9,0	16,0	1,0
44107W20	44107G20	12,5	20,0	2,0
44107W25	44107G25	12,5	23,0	2,5
W= BIANCO/WHITE G= VERDE/GREEN				
44107Y05	44107R05	9,0	9,5	0,5
44107Y10	44107R10	9,0	16,0	1,0
44107Y20	44107R20	12,5	20,0	2,0
44107Y25	44107R25	12,5	23,0	2,5
Y= GIALLO/YELLOW R= ROSSO/RED				
44107O05	44107B05	9,0	9,5	0,5
44107O10	44107B10	9,0	16,0	1,0
44107O20	44107B20	12,5	20,0	2,0
44107O25	44107B25	12,5	23,0	2,5

O= ARANCIONE/ORANGE B= MARRONE/BROWN



Tappo per versatore
Pouring container cap
Dosier-Behälterstopfen
Bouchon à bouteille verseuse
Tapón para recipiente vertedor

art.	u. pack
44106-12	12 pz/pcs



P

Caraffa, MS
Juice pitcher, MS
Saftkanne, MS
Carafe à jus de fruits, MS
Jarra zumo, MS

art.	Ø cm.	h.	lt.
44992-02	16,5	26	2

Antiurto e antigraffio, non idoneo al lavaggio in lavastoviglie, resistente fino a +85°C.
Shockproof, scratchproof, no dishwasher safe, heat resistant up to +85°C.



P

Caraffa, MS
Juice pitcher, MS
Saftkanne, MS
Carafe à jus de fruits, MS
Jarra zumo, MS

art.	Ø cm.	h.	lt.
44992-03	26	29	3



Tagliere con vasca, PE
Cutting board with tray, PE
Tranchierbrett mit Tablett, PE
Planche à découper avec plateau, PE
Tabla de corte con bandeja, PE

art.	dim. cm.	h.
44947-00	33,5x46	5,5



Tagliere bar, PE
Cutting board, PE
Tranchierbrett, PE
Planche à découper, PE
Tabla de corte, PE

art.	dim. cm.	h.
42521-16	16x24,5	1
42521-24	24,5x32,5	1

Con piedini antiscivolo. - With non-slip feet.



P

Portacondimenti, inox
Condiment holder, stainless steel
Bar-Beilagenbehälter, Edelstahl Rostfrei
Boîte à condiments, inox
Caja condimentos, inox

art.	dim. cm.	h.
41782-04	32x16	10
41782-05	39x16	10
41782-06	47x16	10



P

Portacondimenti, ABS
Condiment holder
Bar-Beilagenbehälter
Boîte à condiments
Caja condimentos

art.	dim. cm.	h.	comp.
44103-03	49x15	9	3
44103-04	49x15	9	4
44103-06	49x15	9	6



P

Portacondimenti, acrilico
Condiment holder, acrylic
Bar-Beilagenbehälter, acryl
Boîte à condiments, acrylique
Caja condimentos, acrílico

art.	dim. cm.	h.
44947-03	37x14	12



P

Bordatore bicchieri
Glass rimmer
Bar-Kombination Salz-/Zuckerumrand
Système de givrage de verres
Ribeteador de vasos

art.	Ø cm.
44101-03	15,5



Tappeto sottobicchieri, PE
Bar liner, PE
Gläsermatte, PE
Revêtement de bar, PE
Tapete para vasos, PE

art.	h. cm.	mt.
44099-03	60	13



Tappeto antiscivolo componibile
Bar mat, non-slip
Gläserabstellmatte, rutschfest
Tapis antidérapant, componible
Alfombra antiderrapante, componible

art.	dim. cm.
44100-04	30x30



P

Tappetino bar
Bar runner
Gläserabstellmatte
Tapis à verres
Tapete para vasos

art.	dim. cm.
44100-01	68x8



P

Tappetino bar
Bar runner
Gläserabstellmatte
Tapis à verres
Tapete para vasos

art.	dim. cm.
44100-02	45x30



Valigia Barman, 20 pz
Barman's set, 20 pcs
Barman-Koffer, 20 Stk.
Mallette de barman, 20 pièces
Alfombra, 20 piezas

P

art.

14480-20

Comprende/Includes: 41479-05 boston shaker, 41480-05 shaker, 41503-22 pestello ghiaccio/ice beater, 41595-20 cucchiaino magico/magic spoon, 41603-00 colino cocktail/cocktail strainer, 41604-00 misurino cocktail/cocktail measuring cup, 41605-00 cucchiaino miscelatore/mixing spoon, 41606-00 spremilimone/lemon squeezer, 41606-01 spremilimone/lemon squeezer, 41606-02 spremilime/lime squeezer, 41608-04 tappo champagne/champagne stopper, 41699-06 cavatappi/corkscrew, 44058-10 tappo dosatore 10 ml/dispenser plug 10ml, 48280-02 levacapsule/bottle opener, 48280-56 coltello barman/barman knife, 48280-92 rigalimoni/lemon striper, 48280-96 petarance/orange peeler, 52550-04 cucchiaino ghiaccio/ice spoon, 52550-36 cucchiaino bibita/cocktail spoon, 52550-55 molla ghiaccio/ice tong.



Rastrelliera, inox
Speed rack, stainless steel
Flaschenregal, Edelstahl Rostfrei
Rack à bouteilles, inox
Estantería bar para botellas, inox

art.	dim. cm.	h.	bot.
44060-50	56x10,5	15,5	6
44060-80	81x10,5	15,5	8
44060-99	107x10,5	15,5	10



Rastrelliera, inox
Speed rack, s/s
Flaschenregal, Edelstahl Rostfrei
Rack à bouteilles, inox
Estantería bar para botellas, inox

art.	dim. cm.	h.	bot.
44060-51	56x21	15,5	2x6



Rastrelliera, fissaggio sospeso
Glass shelf rack
Gläserhalter Regalmontage
Rack à verres fixation suspendue
Rack de copas, fijación techo

P

art.	dim. cm.	h.
44060-01	45x31,6	5,5



Rastrelliera, fissaggio murale
Glass wall rack
Gläserhalter Wandmontage
Rack à verres fixation murale
Rack de copas, fijación mural

P

art.	dim. cm.	h.
44060-02	45x31,6	5,5



Lavabicchieri, inox
Glass cleaning brush, stainless steel
Gläserpüler, Edelstahl Rostfrei
Brosse lave-verres, inox
Cepillo lavavasos, inox

art.	dim. cm.	h.
44135-02	38x18	29



Spazzole lavabicchieri, nylon
Glass cleaning brush, nylon
Bierglasbürstenständer, nylon
Brosse lave-verres, nylon
Cepillo lavavasos, nilón

art.	h. cm.
44130-02	16,5
44130-03	21,5



Spazzola lavabicchieri, nylon-alluminio
Glass cleaning brush, nylon-aluminum
Bierglasbürstenständer, nylon-aluminium
Brosse lave-verres, nylon-alu
Cepillo lavavasos, nilón-aluminio

art.	ø cm.	h.
44130-01	15	19



Supporto a parete, alluminio
Aluminum wall mounter bottle rack
Alu-Wandständer
Support pour bouteilles en aluminium
Soporte mural, aluminio

art.	l. cm.	no. bottles
44056-04	41	4
44056-06	67	6

Dosatori non inclusi. - Dispensers not included.



Supporto rotante da banco
Revolving bottle rack
Theken-Drehständer vollständig
Support rotatif de comptoir
Soporte giratorio

art.	h. cm.	no. bottles
44057-04	70	4
44057-06	70	6



Supporto bottiglia, alluminio
Standard aluminum support
Alu-Standard Ständer,
Support en aluminium
Soporte de botella, aluminio

art.	col.
44056-01	alluminio/aluminum
N 44056-11	oro/gold
N 44056-21	nero/black

Fissaggio universale, a ripiano o parete.
Universal fitting, shelf or wall mounting.



Dosatore cromato
Chrome plated dispenser
Verchromter Dosierer
Doseur chromé
Dosificador cromado

art.	cc.
44055-10	10
44055-50	50



Dosatore cromato
Chrome plated dispenser
Verchromter Dosierer
Doseur chromé
Dosificador cromado

art.	cc.
44055-20	20
44055-25	25
44055-30	30
44055-35	35
44055-40	40



Dosatore, metallo
Dispenser head, metal
Dosierer, Metall
Doseur, métal
Dosificador, metal

art.	cc.	col.
44055G30	30	oro/gold
44055G40	40	oro/gold
44055C30	30	rame/copper
44055C40	40	rame/copper





Tappo dosatore automatico
Automatic dispenser plug
Automatischer Portionierer
Bouchon doseur automatique
Bola dosificadora

art.	cc.
44058-20	20
44058-25	25
44058-30	30



Tappo dosatore automatico
Automatic dispenser plug
Automatischer Portionierer
Bouchon doseur automatique
Tapón dosificador automático

art.	cc.
44058-10	10
44058-40	40
44058-50	50



Tappo versatore con chiusura, inox
Bottle pourer with stopper, stainless steel
Ausgießer mit Kappe, Edelstahl Rostfrei
Bouchon avec clapet, inox
Tapón vertedor con clerre inox

art.	u. pack
44111-02	2



Tappo versatore continuo
Free flow pourer
Permanentausgiesser
Bouchon verseur continu
Vertedor continuo

art.	u. pack	col.	art.	u. pack	col.
44110-01	12	●	44110-04	12	●
44110-02	12	●	44110-05	12	○
44110-03	12	●	44110-06	12	●



Tappo versatore continuo
Free flow pourer
Permanentausgiesser
Bouchon verseur continu
Vertedor continuo

art.	u. pack
44110-00	12



Tappo versatore dosatore
Measuring pourer
Dosierausgiesser
Bouchon verseur doseur
Tapón vertedor dosificador

art.	u. pack	col.
44119-01	6	●
44119-02	6	●
44119-03	6	●
44119-04	6	●
44119-06	6	●



Tappo versatore dosatore
Measuring pourer
Dosierausgiesser
Bouchon verseur doseur
Tapón vertedor dosificador

art.
44114-01
44114-02
44114-03



Tappo metrico
Measured pourer
Portioniererausgiesser
Bouchon doseur
Caños dosificador

art.	u. pack	cc.	col.	art.	u. pack	cc.	col.
44118-10	6	10	●	44118-35	6	35	●
44118-20	6	20	●	44118-40	6	40	●
44118-25	6	25	●	44118-50	6	50	○
44118-30	6	30	●				



Tappo versatore
Whiskey pourer
Ausgiesser
Bouchon verseur
Vertedor

art.	u. pack	col.
44112-01	12	black
44112-02	12	clear



N

Tappo spumante/champagne
Champagne stopper
Sektflaschenstopfen
Bouchon à champagne
Tapón Champaña

art.
41608-20



Tappo spumante, inox
Champagne stopper, stainless steel
Sektflaschenstopfen, Edelstahl Rostfrei
Bouchon à champagne, inox
Tapón Champaña, inox

art.
41608-04



Tappo spumante Perlage, inox
Perlage stopper, stainless steel
Sektflaschenstopfen, Perlage, Edelstahl
Bouchon Perlage, inox
Tapón Champaña, inox

art.
41608-08



Tappo champagne, inox
Champagne bottle cap, stainless steel
Sektflaschenstopfen, Edelstahl Rostfrei
Bouchon à champagne, inox
Tapón Champaña, inox

art.
41608-00



Tappo spumante, inox
Champagne stopper, stainless steel
Sektflaschenstopfen, Edelstahl Rostfrei
Bouchon à champagne, inox
Tapón Champaña, inox

art.
56796-00



Tappo vino, inox
Wine stopper, stainless steel
Weinflaschenstopfen, Edelstahl Rostfrei
Bouchon à vin, inox
Tapón vino, inox

art.
41608-03



Taglia capsula
Foil cutter
Folienchneider
Coupe-capsules
Cortacápsulas

art.
49858-07



P

Cavatappi a doppia leva
Winged corkscrew
Korkenzieher mit Doppelhebel
Tire-bouchon à double levier
Sacacorchos a doble palanca

art.
41699-10



P

Cavatappi a doppia leva
Winged corkscrew
Korkenzieher mit Doppelhebel
Tire-bouchon à double levier
Sacacorchos a doble palanca

art.
41699-11



N

Levatappi cameriere
Waiter's corkscrew
Kellner Korkenzieher
Tire-bouchon sommelier
Sacacorchos camarero

art.
41699-20



P

Cavatappi cameriere
Waiter's corkscrew
Kellner Korkenzieher
Tire-bouchon sommelier
Sacacorchos camarero

art.
41699-08



P

Cavatappi cameriere
Waiter's corkscrew
Kellner Korkenzieher
Tire-bouchon sommelier
Sacacorchos camarero

art.
41699-06



P

Cavatappi, plastica
Plastic lever corkscrew
Korkenzieher, kunststoff
Tire-bouchon, plastique
Sacacorchos, plastico

art.
49858-01



P

Cavatappi, cromato
Metal lever corkscrew
Korkenzieher, verchromt
Tire-bouchon, chromé
Sacacorchos, cromado

art.
49858-00



P

Set cavatappi cameriere
Waiter's corkscrew case
Kellner Korkenzieher-Koffer
Mallette tire-bouchon sommelier
Maletín sacacorchos sumiller

art.
49858-06



Cavatappi da banco
Table top corkscrew
Theken-Hebelkorkenzieher
Tire-bouchon de comptoir
Sacacorchos de mesa

art. kg.
49857-00 2,8



Cavatappi da parete
Wall mounted uncorking machine
Wand-Korkenzieher
Tire-bouchon à paroi
Sacacorchos mural

art. kg.
49859-00 2,7



Levacapsule con contenitore di raccolta
Bottle opener with collector box
Flaschenöffner mit Sammelbehälter
Décapsuleur avec récipient de récupération
Abridor de botellas + caja de recuperación

art. dim. cm. h.
48223-00 10,5x7,2 30

Per estrazione di tappi in sughero. Per tappi in acrilico ordinare il verme 49857-AB.
To uncork bottles with normal corks. For acrylic corks please order item 49857-AB.



Levacapsule, inox
Bottle opener, stainless steel
Flaschenöffner, Edelstahl Rostfrei
Décapsuleur, inox
Abrebotellas, inox

art. dim. cm.
41699-12 11x4



Levacapsule, inox
Bottle opener, stainless steel
Flaschenöffner, Edelstahl Rostfrei
Décapsuleur, inox
Abrebotellas, inox

art. dim. cm.
41699-04 11x4



Fondina per levacapsule
Bar blade holster with belt clip
Flaschenöffner-Halter
Etui pour décapsuleur
Funda para abrebotellas

art.
41699-13



Levacapsule nichelato
Bottle opener, nickelplated
Flaschenöffner, vernickelt
Décapsuleur, nickelé
Abrebotellas, niquelado

art.
41699-03



Apriscatole / levacapsule, inox
Can punch and bottle opener, s/s
Dosen-/Flaschenöffner, Edelstahl
Ouvre-boîte / décapsuleur, inox
Abrelatas/botellas, inox

art.
49860-00



Pompa sottovuoto per vino
Vacuum pump wine preserver
Wein-Vakuum-Pumpe
Pompe à vide d'air
Bomba vacío vino

art.
41499-00





Vetrina da banco, plexiglas
Showcase, plexiglas
Vitrine für Verkaufstheke, Plexiglas
Vitrine à comptoir, plexiglas
Vitrina, plexiglas

art.	dim. cm.	h.
41472-30	60x37	36



Vetrina brioches, plexiglas
Showcase, plexiglas
Vitrine für Brioches, Plexiglas
Vitrine brioches, plexiglas
Vitrina brioches, plexiglas

art.	dim. cm.	h.
41472-31	50x33	53



Vetrina da banco, plexiglas
Showcase, plexiglas
Vitrine für Verkaufstheke, Plexiglas
Vitrine à comptoir, plexiglas
Vitrina, plexiglas

art.	dim. cm.	h.
41472-32	37x31	31



Vetrina da banco
Showcase
Vitrine für Verkaufstheke
Vitrine à comptoir
Vitrina

art.	dim. cm.	h.
47091-01	44x32	20,5



Vetrina da banco, 2 piani
Showcase, 2 tiers
Vitrine für Verkaufstheke, doppeldecker
Vitrine à comptoir, 2 étages
Vitrina, doble

art.	dim. cm.	h.
47091-02	44x32	44,0



Contenitore universale, impilabile
Sweet box, stackable
Universalbox, stapelbar
Boîte, empilable
Exhibidor, apilable

art.	dim. cm.	h.
47090-23	23x14,5	15

Apertura doppio fronte. Forniti con vassoi inox e eutettici.
Double side opening. Equipped with stainless steel tray and coolers.



Piatto torta, melamina
Cake tray, melamine
Tortenplatte, Melamin
Plat gâteau, melamine
Bandeja pasteles, melamine

art.	Ø cm.	h.
44845-31	31	4



Alzata torta, inox
Swivel cake stand, stainless steel
Tortenplatte drehbar, Edelstahl Rostfrei
Gueridon pâtissier tournante, inox
Pedestal giratorio para tartas, inox

art.	Ø cm.	h.
47101-31	30,5	9



Cloche, PS
Dome cover, PS
Abdeckhaube, PS
Cloche, PS
Campana, PS

art.	Ø cm.	h.
41414-30	30	9,5

Per art./for item: 44845-31/47101-31



Tortiera con coperchio, acrilico
Cake tray with cover, acrylic
Tortenplatte mit Dekkel, Acryl
Plateau à tarte avec couvercle, acrylique
Bandeja tartas con tapa, acrílico

art.	Ø cm.	h.
44947-06	32	15



Piatto tondo, melamina
Round dish, melamine
Platte, rund, Melamin
Plat rond, melamine
Bandeja redonda, melamine

art.	Ø cm.	h.
44845-38	38	2



Coperchio roll-top
Roll-top cover
Rolltophaube
Couvercle roll-top
Campana roll-top

art.	Ø cm.	h.
41447-38	38	20

Per art./for item: 44845-38



Piatto tondo, melamina
Round dish, melamine
Platte, rund, Melamin
Plat rond, melamine
Bandeja redonda, melamine

art.	Ø cm.	h.
44845-37	37	2,5



Cloche, PS
Dome cover, PS
Abdeckhaube, PS
Cloche, PS
Campana, PS

art.	Ø cm.	h.
41414-33	33	12
Per art./for item: 44845-37		



Alzata torta, inox
Cake stand, stainless steel
Tortenplatte, Edelstahl Rostfrei
Gueridon pâtissier, inox
Pedestal para tartas, inox

art.	Ø cm.	h.
41538-20	20	5
41538-24	24	5
41538-30	30	5
41538-36	36	5



Alzata torta, inox 18-8
Cake stand, stainless steel
Tortenplatte, Edelstahl Rostfrei
Gueridon pâtissier, inox
Pedestal para tartas, inox

art.	Ø cm.	h.
41537-34	34,5	13,5



Campana, PS
Dome cover, PS
Frischhalte-Haube, PS
Cloche, PS
Cubierta, PS

art.	Ø cm.	h.
41537-33	33	12,5
Per art./for item: 41537-34		



Alzata torta, inox
Cake stand, stainless steel
Tortenplatte, Edelstahl Rostfrei
Gueridon pâtissier, inox
Pedestal para tartas, inox

art.	Ø cm.	h.
47099-22	22	10
47099-30	30	10
47099-36	36	10



Alzata torta
Cake stand
Tortenplatte
Gueridon pâtissier
Pedestal para tartas



art.	Ø cm.	h.
44873-08	31	8



Alzata torta
Cake stand
Tortenplatte
Gueridon pâtissier
Pedestal para tartas



art.	Ø cm.	h.
44873-16	31	16



Alzata torta
Cake stand
Tortenplatte
Gueridon pâtissier
Pedestal para tartas



art.	dim. cm.	h.
44874-08	31x31	8



Alzata torta
Cake stand
Tortenplatte
Gueridon pâtissier
Pedestal para tartas



art.	dim. cm.	h.
44874-16	31x31	16





Dalle torte ai dolci - le alzate singole e multiple sono perfette per la presentazione di una vasta gamma di prodotti da forno e si possono combinare con campane e copripiatti. - **From cakes to pastries – the single and multi-tier cake stands are perfect for presenting a wide range of baked goods, and can be combined with cloches and cake/roll-top covers.**



Piatto torta
Cake platter
Tortenplatte
Plat gâteau
Bandeja pasteles

art.	ø cm.	h.
44475-71	18,5	1,5
44475-72	23,5	1,5



Piatto torta
Cake platter
Tortenplatte
Plat gâteau
Bandeja pasteles

art.	ø cm.	h.
44475-73	35,0	1,5
44475-74	42,5	1,5



Alzata dolci, 3 piani
Pastry stand, 3 tiers
Gebäckständer, 3-stöckig
Serviteur muet, 3 étages
Soporte dulces, 3 niveles

art.	ø cm.	h.
44475-75	35-23,5-18,5	40



Coperchio roll-top
Roll-top cover
Rolltophaube
Couvercle roll-top
Campana roll-top

art.	ø cm.	h.	per/for
41447-38	38	20	44475-74 44845-38 44475-78 44475-79



Cloche, SAN
Cover
Haube
Couvercle
Tapa

art.	ø cm.	h.	per/for
44475-85	16,5	10	44470-60
44475-86	20,5	10	44470-61



Cloche, SAN
Cover
Haube
Couvercle
Tapa

art.	ø cm.	h.	per/for
44475-87	30	11,5	44470-62
41537-33	33	12,5	44470-63 44475-78 44475-79

N  **WOOD**



In legno chiaro oppure scuro, le basi permettono di presentare i vari elementi della gamma APS Plus e le vostre creazioni culinarie su due livelli. Per esempio, in combinazione con un coperchio roll-top, il tagliere può essere utilizzato come piatto formaggio - **In dark or light wood, the bases enable many other items from the APS Plus collection and your dishes to be presented at two different heights. Combined with a roll-top cover, the wooden chopping board can be used as a cheese platter, for example.**



Piatto torta
Cake platter
Tortenplatte
Plat gâteau
Bandeja pasteles

art.	ø cm.	h.
44475-76	30,0	2
44475-78	38,5	2

Piatto torta
Cake platter
Tortenplatte
Plat gâteau
Bandeja pasteles

art.	ø cm.	h.
44475-77	30,0	2
44475-79	38,5	2

Alzata
Riser
Ständer
Support
Soporte

art.	ø cm.	h.
44475-80	15-11,5	10,5
44475-82	21-15	20,0



Alzata
Riser
Ständer
Support
Soporte

art.	ø cm.	h.
44475-81	15-11,5	10,5
44475-83	21-15	20,0





P

Bicchieri whiskey, PC
Whiskey glass, PC
Whiskey Gläser, PC
Verre à whiskey, PC
Vaso para whiskey, PC

art.	Ø cm.	h.	ml.	u.pack
44940-01	8,5	9,5	420	6



P

Bicchieri succo, PC
Juice glass, PC
Fruchtsaft-Gläser, PC
Verre à jus, PC
Vaso para zumo, PC

art.	Ø cm.	h.	ml.	u.pack
44940-02	7,5	15,5	460	6



P

Boccali birra, PC
Beer glasses, PC
Bier-Gläser, PC
Verre à bière, PC
Vaso para cerveza, PC

art.	Ø cm.	h.	ml.	u.pack
44940-06	8	23	450	6



P

Boccali birra, MS
Beer glasses, MS
Bier-Gläser, MS
Verre à bière, MS
Vaso para cerveza, MS

art.	Ø cm.	h.	ml.	u.pack
44940-08	9	16	500	6



P

Bicchieri margarita, PC
Margarita glass, PC
Margarita-Gläser, PC
Verre à margarita, PC
Vaso margarita, PC

art.	Ø cm.	h.	ml.	u.pack
44940-10	12	18	300	6



P

Bicchieri martini, PC
Martini glass, PC
Martini-Gläser, PC
Verre à martini, PC
Vaso martini, PC

art.	Ø cm.	h.	ml.	u.pack
44940-11	12	17	240	6

BAR HAPPY HOUR BUFFET



Bicchiere vino, PC
Wine glass, PC
Wein-Gläser, PC
Verre à vin, PC
Vaso vino, PC

art.	Ø cm.	h.	ml.	u.pack
44940-12	7	21	300	6



Bicchiere vino, PC
Wine glass, PC
Wein-Gläser, PC
Verre à vin, PC
Vaso vino, PC

art.	Ø cm.	h.	ml.	u.pack
44940-13	7	19	200	6



Bicchiere spumante, PC
Champagne glass, PC
Sekt-Gläser, PC
Flûte, PC
Vaso champaña, PC

art.	Ø cm.	h.	ml.	u.pack
44940-14	5	22	180	6



Bicchiere, PC
Mixing glass, PC
Gläser, PC
Verre, PC
Vaso, PC

art.	Ø cm.	h.	ml.	u.pack
44940-16	9	16	540	6



Bicchiere whiskey/rocks, PC
Whiskey/rocks glass, PC
Whiskey-/Rocks-Gläser, PC
Verre à whiskey/rocks, PC
Vaso para whiskey/rocks, PC

art.	Ø cm.	h.	ml.	u.pack
44940-17	9,0	12,0	420	6



Bicchiere whiskey/rocks, PC
Whiskey/rocks glass, PC
Whiskey-/Rocks-Gläser, PC
Verre à whiskey/rocks, PC
Vaso para whiskey/rocks, PC

art.	Ø cm.	h.	ml.	u.pack
44940-18	8,5	11,5	420	6



Bicchiere, PC
Cooler, PC
Gläser, PC
Verre, PC
Vaso, PC

art.	Ø cm.	h.	ml.	u.pack
44940-19	8	17	540	6



Bicchiere, PC
Tumbler, PC
Trinkbecher, PC
Gobelet, PC
Vaso, PC

art.	Ø cm.	h.	ml.	u.pack
44940-24	7,5	12,5	360	6
44940-25	8,0	13,5	480	6
44940-26	8,5	16,0	660	6



Bicchiere, PC
Tumbler, PC
Trinkbecher, PC
Gobelet, PC
Vaso, PC

art.	Ø cm.	h.	ml.	u.pack
44940-32	7,5	12,5	360	6
44940-33	8,0	13,5	480	6
44940-34	8,5	16,0	660	6



Bicchiere zigrinato, SAN
Clear tumbler, SAN
Trinkbecher, SAN
Gobelet transparent, SAN
Vaso transparente, SAN

art.	Ø cm.	h.	ml.	u.pack
44990-15	5,5	9,5	150	6
44990-24	6,5	10,0	240	6
44990-29	7,0	11,0	290	6
44990-36	7,5	13,0	360	6
44990-48	8,0	15,0	480	6



Bicchiere acqua, PC
Water tumbler, PC
Wasserglas, PC
Verre à eau, PC
Vaso agua, PC

art.	Ø cm.	h.	ml.	u.pack
44871-20	7,0	7,0	170	10
44871-21	7,0	10,2	250	10
44871-22	7,8	11,4	350	10

Impilabile. - Stackable.



Coperchio con beccuccio, PP
Cover with spout, PP
Deckel mit Ausguss, PP
Couvercle avec bec, PP
Tapa con boquilla, PP

art.	Ø cm.	u.pack
44871-23	7	50



Bicchieri cocktail, MS
Cocktail glasses, MS
Cocktail Gläser, MS
Verres à cocktail, MS
Vasos para cocktail, MS

art.	Ø cm.	h.	ml.	u.pack
44942-01	8	21	350	6



Bicchieri cocktail, MS
Cocktail glasses, MS
Cocktail Gläser, MS
Verres à cocktail, MS
Vasos para cocktail, MS

art.	Ø cm.	h.	ml.	u.pack
44942-02	11	21	460	6



Bicchieri martini, MS
Martini glasses, MS
Martini-Gläser, MS
Verres à martini, MS
Vasos martini, MS

art.	Ø cm.	h.	ml.	u.pack
44942-03	10,5	20	340	6



Bicchieri cocktail, MS
Cocktail glasses, MS
Cocktail Gläser, MS
Verres à cocktail, MS
Vasos para cocktail, MS

art.	Ø cm.	h.	ml.	u.pack
44942-04	7,5	23	220	6



Bicchieri margarita, MS
Margarita glasses, MS
Margarita-Gläser, MS
Verres à margarita, MS
Vasos margarita, MS

art.	Ø cm.	h.	ml.	u.pack
44942-05	12	17,5	340	6



Stuzzicadenti in legno
Wooden toothpicks
Holz-Zahnstocher
Cure-dents en bois
Palillos

art.	l. cm.	u.pack
48306-01	9	1000

Betulla, 2 punte, imbustati singolarmente. - Birch, double pointed, individually wrapped.



Spiedini legno
Wooden skewers
Holz-Fleischspieß
Brochettes en bois
Pinchos madera

art.	l. cm.	u.pack
48307-01	15	100
48307-02	20	100
48307-03	25	100



Spiedini noshikushi, bamboo
Noshikushi skewers, bamboo
Noshikushi Spieße, Bambus
Brochettes noshikushi, bambou
Pinchos noshikushi, bambú

art.	l. cm.	u. pack
48300-42	10,5	100



Spiedini tepokushi, bamboo
Tepokushi skewers, bamboo
Tepokushi Spieße, Bambus
Brochettes tepokushi, bambou
Pinchos tepokushi, bambú

art.	l. cm.	u. pack
48300-43	9	100
48300-33	15	100



Vassoietto party
Party tray
Party-Tablett
Plateau party
Bandeja party

art.	dim. cm.
44049-01	25x18 nero-black
44049-02	25x18 bianco-white



Cucchiaino SAN, monouso
Small spoon, SAN, disposable
Löffel, klein, SAN
Petit cuiller, SAN
Cucharita, SAN

art.	l. cm.	u.pack
48345-02	12	24



Forchettina SAN, monouso
Small fork, SAN, disposable
Gabel, klein, SAN
Petite fourchette, SAN
Tenedor, SAN

art.	l. cm.	u.pack
48345-04	12 24	nero-black

BAR HAPPY HOUR BUFFET



Clip reggibicchiere, PC
Glass clip holder, PC
Glshalter
Clip porte-verre
Soporte para vidrio

art.	u.pack
44048-99	100



Forchettina party, inox
Party fork, stainless steel
Party-Gabel, Edelstahl Rostfrei
Fourchette apéro, inox
Tenedor party, inox

art.	l. cm.	u.pack
62550B27	12,5	12



Forchettina party, inox
Party fork, stainless steel
Party-Gabel, Edelstahl Rostfrei
Fourchette apéro, inox
Tenedor party, inox

art.	l. cm.	u.pack
62550B29	12,5	12



Forchettina plastica, monouso
Small fork, plastic, disposable
Gabel, klein
Petite fourchette
Tenedor

art.	l. cm.	u.pack
48362-01	8,5	500



Cucchiaino plastica, monouso
Small spoon, plastic, disposable
Löffel, klein
Petit cuiller
Cucharita

art.	l. cm.	u.pack
48363-01	8,5	500



Spiedini plastica, monouso
Spits, plastic, disposable
Fleischspieß
Brochettes
Palos

art.	l. cm.	u.pack
48364-09	9	500
48364-12	12	500



Bicchierino degustazione
Tasting glass
Verkostung Glas
Verre dégustation
Vaso degustación

art.	Ø cm.	h.	ml.	u.pack
48353-01	8,5	6,5	120	100



Bicchierino degustazione
Tasting glass
Verkostung Glas
Verre dégustation
Vaso degustación

art.	Ø cm.	h.	ml.	u.pack
48354-01	4	8,5	70	100



Piattino degustazione
Tasting dish
Verkostung Schale
Assiette dégustation
Platillo degustación

art.	Ø cm.	h.	ml.	u.pack
48355-01	9	1,5	20	100



Ciotolina degustazione
Tasting bowl
Verkostung Schale
Bol dégustation
Bol degustación

art.	Ø cm.	h.	ml.	u.pack
48356-01	8,5	3	30	100



Ciotolina degustazione
Tasting bowl
Verkostung Schale
Bol dégustation
Bol degustación

art.	Ø cm.	h.	ml.	u.pack
48357-01	7,5	3	50	100



Ciotolina degustazione
Tasting bowl
Verkostung Schale
Bol dégustation
Bol degustación

art.	dim. cm.	h.	ml.	u.pack
48358-01	10,5x5	3	11	100



Piattino degustazione
Tasting dish
Verkostung Schale
Assiette dégustation
Platillo degustación

art.	Ø cm.	h.	ml.	u.pack
48359-01	6,5	1,5	15	100



Piattino degustazione
Tasting dish
Verkostung Schale
Assiette dégustation
Platillo degustación

art.	dim. cm.	h.	ml.	u.pack
48360-01	11x6,5	2	20	100



Piattino degustazione
Tasting dish
Verkostung Schale
Assiette dégustation
Platillo degustación

art.	dim. cm.	h.	ml.	u.pack
48361-01	11,5x10,5	1,5	30	100



Portasalatini, acrilico
Olive plate, acrylic
Salzgebäckständer, Acryl
Porte-appetizers, acrylique
Entremesera, acrílico

art.	dim. cm.	h.
44991-04	11,5x18	9,5



Portasalatini, acrilico
Swirl appetizer, acrylic
Salzgebäckständer, Acryl
Porte-appetizers, acrylique
Entremesera, acrílico

art.	dim. cm.	h.
44991-01	19x18	3



Coppa punch con coperchio, acrilico
Punch bowl with lid, acrylic
Punchbowle mit Deckel, Acryl
Bol à punch avec couvercle, acrylique
Ponchero con tapa, acrílico

art.	Ø cm.	h.	lt.
44947-01	28	22,3	5,4



Ciotola aperitivi, acrilico
Hors d'oeuvre bowl, acrylic
Vorspeisenschale, Acryl
Bol hos d'oeuvres, acrylique
Entremesera, acrílico

art.	Ø cm.	h.
44947-05	28	23



Antipastiera, acrilico
Appetizer tray, acrylic
Vorspeisenteller, Acryl
Plateau hos d'oeuvres, acrylique
Entremesera, acrílico

art.	Ø cm.	h.
44947-02	42	6,5



P

Antipastiera con coperchio, acrilico
Appetizer tray with lid, acrylic
Vorspeiseteller mit Deckel, Acryl
Plateau hos d'oeuvres, acrylique
Entremesera con tapa, acrílico

art.	dim. cm.	h.
44947-08	36,5x36,5	17



P

Antipastiera acrilico con inserto inox
Acrylic appetizer tray with s/s plate
Vorspeiseteller, Acryl
Plateau hos d'oeuvres, acrylique
Entremesera, acrílico

art.	Ø cm.	h.
44947-04	36	7



P

Antipastiera con coperchio, acrilico
Appetizer tray with lid, acrylic
Vorspeiseteller mit Deckel, Acryl
Plateau hos d'oeuvres, acrylique
Entremesera con tapa, acrílico

art.	dim. cm.	h.
44947-09	50x29	20



Porta snack, acrilico
Snack holder, acrylic
Snack-Behälter, Acryl
Conteneur à snack, acrylique
Contenedor para snack, acrílico

art.	dim. cm.	h.
44947-07	15x20	5



Porta snack, inox
Mini pail, stainless steel
Snack-Behälter, Edelstahl
Conteneur à snack, inox
Contenedor para snack, inox

art.	Ø cm.	h.	lt.
41524-09	9	8,5	0,33



Porta snack, 4 pezzi, inox
Mini pail, 4 pcs, stainless steel
Snack-Behälter, 4er Set, Edelstahl
Conteneur à snack, 4 pièces, inox
Contenedor para snack, 4 pz, inox

art.	Ø cm.	h.	lt.
41524-04	7	6,5	0,15



Porta snack, inox
Snack holder, stainless steel
Snack-Behälter, Edelstahl
Conteneur à snack, inox
Contenedor para snack, inox

art.	dim. cm.	h.
41527-12	10x8,5	6,5
41527-13	13x10,5	9,0



Porta snack, inox
Snack holder, stainless steel
Snack-Behälter, Edelstahl
Conteneur à snack, inox
Contenedor para snack, inox

art.	Ø cm.	h.
41523-08	8	7,5
41523-09	9	8,5



N

Porta snack, inox
Snack holder, stainless steel
Snack-Behälter, Edelstahl
Conteneur à snack, inox
Contenedor para snack, inox

art.	dim. cm.	h.
41527-10	21,5x10,5	4,5
41527-11	26x13	5,0



N

Mini colapasta, inox
Snack holder, stainless steel
Mini-Seiher, Edelstahl
Conteneur à snack, inox
Contenedor para snack, inox

art.	Ø cm.	h.
41521-10	10	6
41521-13	13	6



N

Mini tegame, inox
Snack holder, stainless steel
Mini-Servierfanne, Edelstahl
Conteneur à snack, inox
Contenedor para snack, inox

art.	dim. cm.	h.	lt.
41522-14	14,5x9,5	4,5/6,5	0,5



N

Porta snack, inox
Snack holder, stainless steel
Snack-Behälter, Edelstahl
Conteneur à snack, inox
Contenedor para snack, inox

art.	dim. cm.	h.
41527G10	21,5x10,5	4,5
41527G11	26x13	5,0



N

Porta snack, inox
Snack holder, stainless steel
Snack-Behälter, Edelstahl
Conteneur à snack, inox
Contenedor para snack, inox

art.	dim. cm.	h.
41527G12	10x8,5	6,5
41527G13	13x10,5	9,0



N

Porta snack, inox
Snack holder, stainless steel
Snack-Behälter, Edelstahl
Conteneur à snack, inox
Contenedor para snack, inox

art.	ø cm.	h.
41523G08	8	7,5
41523G09	9	8,5



N

Porta snack, inox
Snack holder, stainless steel
Snack-Behälter, Edelstahl Rostfrei
Conteneur à snack, inox
Contenedor para snack, inox

art.	ø cm.	h.	lt.
41524-10	9,5	8,5-11,5	0,45



N

Porta snack, inox
Snack holder, stainless steel
Snack-Behälter, Edelstahl Rostfrei
Conteneur à snack, inox
Contenedor para snack, inox

art.	ø cm.	h.	lt.
41524-11	8,5	8,5	0,35



N

Porta snack, inox
Snack holder, stainless steel
Snack-Behälter, Edelstahl Rostfrei
Conteneur à snack, inox
Contenedor para snack, inox

art.	ø cm.	h.	lt.
41524-12	8,5	8,5	0,35



N

Porta snack, inox/rame
Snack holder, stainless steel/copper
Snack-Behälter, Edelstahl Rostfrei/Kupfer
Conteneur à snack, inox/cuivre
Contenedor para snack, inox/cobre

art.	ø cm.	h.	lt.
41524C10	9,5	8,5-11,5	0,45



N

Porta snack, inox/rame
Snack holder, stainless steel/copper
Snack-Behälter, Edelstahl Rostfrei/Kupfer
Conteneur à snack, inox/cuivre
Contenedor para snack, inox/cobre

art.	ø cm.	h.	lt.
41524C11	8,5	8,5	0,35



N

Porta snack, inox/rame
Snack holder, stainless steel/copper
Snack-Behälter, Edelstahl Rostfrei/Kupfer
Conteneur à snack, inox/cuivre
Contenedor para snack, inox/cobre

art.	ø cm.	h.	lt.
41524C12	8,5	8,5	0,35



Dosatore, acrilico
Dispenser, acrylic
Dosierspender, Acryl-Behälter
Doseur, acrylique
Dispensador, acrílico

art.	ml.
47609-02	250
47609-03	350
47609-09	950
47609-13	1350



Dosatore, acrilico
Dispenser, acrylic
Dosierspender, Acryl-Behälter
Doseur, acrylique
Dispensador, acrílico

art.	ml.
47609-04	375
47609-07	750
47609-12	1250
47609-16	1650



Dosatore, inox
Lever dispenser, stainless steel
Hebeldosierspender, Edelstahl Rostfrei
Distributeur à manette, inox
Dispensador, inox

art.	ø cm.	h.
41528-21	21	22,5
41528-22	22	18,0

Per bidone da kg 5.
Suitable for 5 kg bucket.

BAR HAPPY HOUR BUFFET



Flacone dosatore in polietilene
Squeeze bottle, polyethylene
Quetschflasche, PE
Flacon doseur, polyéthylène
Frasco dosificador, polietileno

art.	ml.
41526-R1	240
41526-R2	360
41526-R3	720



Flacone dosatore in polietilene
Squeeze bottle, polyethylene
Quetschflasche, PE
Flacon doseur, polyéthylène
Frasco dosificador, polietileno

art.	ml.
41526-B1	240
41526-B2	360
41526-B3	720



Flacone dosatore in polietilene
Squeeze bottle, polyethylene
Quetschflasche, PE
Flacon doseur, polyéthylène
Frasco dosificador, polietileno

art.	ml.
41526-G1	240
41526-G2	360
41526-G3	720



Flacone dosatore in polietilene
Squeeze bottle, polyethylene
Quetschflasche, PE
Flacon doseur, polyéthylène
Frasco dosificador, polietileno

art.	ø cm.	h.	ml.
41526-11	7	21,0	335
41526-14	8	24,5	700



Flacone dosatore in polietilene
Squeeze bottle, polyethylene
Quetschflasche, PE
Flacon doseur, polyéthylène
Frasco dosificador, polietileno

art.	ø cm.	h.	ml.
41526-12	7	21,0	335
41526-15	8	24,5	700



Flacone dosatore in polietilene
Squeeze bottle, polyethylene
Quetschflasche, PE
Flacon doseur, polyéthylène
Frasco dosificador, polietileno

art.	ø cm.	h.	ml.
41526-10	7	21,0	335
41526-13	8	24,5	700



Flacone dosatore in polietilene
Squeeze bottle, polyethylene
Quetschflasche, PE
Flacon doseur, polyéthylène
Frasco dosificador, polietileno

art.	ø cm.	h.	ml.
41526-05	5,0	18	200
41526-06	5,5	19	350



Flacone dosatore mini, 4 pz, PE
Squeeze bottle, 4 pcs, PE
Quetschflasche, Mini, 4er Set, PE
Flacon doseur, 4 pièces, PE
Frasco dosificador, 4 piezas, PE

art.	ø cm.	h.	ml.
41526-01	3	8,5	30



Flacone dosatore mini, 4 pz, PE
Squeeze bottle, 4 pcs, PE
Quetschflasche, Mini, 4er Set, PE
Flacon doseur, 4 pièces, PE
Frasco dosificador, 4 piezas, PE

art.	ø cm.	h.	ml.
41526-02	3,5	9,5	50



BUFFET & PRESENTATION



Approfitta delle qualità della melamina!

I pratici pezzi a servire sono al 100% in pura melamina e offrono vantaggi che i Professionisti con il loro utilizzo quotidiano potranno apprezzare: di prima qualità, esteticamente assomiglia alla porcellana; estremamente resistente alla rottura, non produce schegge pericolose; superficie liscia e lucida; robusta e solida, lavabile in lavastoviglie e utilizzabile in frigo/freezer; resistente da -30°C a +70°C; non assorbe odori e sapori; ideale per una presentazione degli alimenti ecocompatibile ed igienica.

Take advantage of the merits (qualities) of melamine!

These practical serving pieces are 100% pure melamine and offer benefits that all Professionals will appreciate with the everyday use: top quality, looks like premium porcelain; extremely resistant to breakage; does not produce dangerous splinters; hard, glossy surface; sturdy and durable; dishwasher safe, suitable for refrigerator and freezer; resistant from -30°C to +70°C; does not absorb odors and flavors; ideal for an environment-friendly and hygienic food presentation.



Supporto cromato "Quadro S"
Serving stand, chrome plated
Serviergestell, hartverchromt
Présentoir, acier chromé
Soporte platos pastre, acero cromado

art.	dim. cm.	h.
44840-01	29x17	41
Per 3 piatti cm. 18x18 oppure 21x21. For 3 plates cm. 18x18 or 21x21.		

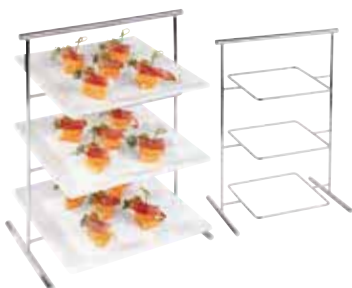

Supporto cromato "Quadro M"
Serving stand, chrome plated
Serviergestell, hartverchromt
Présentoir, acier chromé
Soporte platos pastre, acero cromado

art.	dim. cm.	h.
44840-02	33x21	44
Per 3 piatti cm. 21x21 oppure 26,5x26,5. For 3 plates cm. 21x21 or 26,5x26,5.		



Supporto cromato "Buffet"
Serving stand, chrome plated
Serviergestell, hartverchromt
Présentoir, acier chromé
Soporte platos pastre, acero cromado

art.	dim. cm.	h.
44840-03	37x21	44
Per 3 piatti cm. 30x21. For 3 plates cm. 30x21.		



Supporto cromato "Buffet"
Serving stand, chrome plated
Serviergestell, hartverchromt
Présentoir, acier chromé
Soporte platos pastre, acero cromado

art.	dim. cm.	h.
44840-20	45x37	72
Per 3 piatti cm. 37x37. For 3 plates cm. 37x37.		



Supporto cromato
Serving stand, chrome plated
Serviergestell, hartverchromt
Présentoir, acier chromé
Soporte platos pastre, acero cromado

art.	dim. cm.	h.
44840-05	37,5x37,5	50
Per piatti di 3 diverse misure: cm. 21x21-26,5x26,5-37x37. - For plates in 3 different sizes: cm. 21x21-26,5x26,5-37x37.		



Supporto cromato "GN"
Serving stand, chrome plated
Serviergestell, hartverchromt
Présentoir, acier chromé
Soporte platos pastre, acero cromado

art.	dim. cm.	h.
44840-04	63x27	44,5
Per 2 piatti cm. 53x32,5 oppure 4 piatti cm. 53x16,2. - For 2 plates cm. 53x32,5 or 4 plates cm. 53x16,2.		



Supporto cromato
Serving stand, chrome plated
Serviergestell, hartverchromt
Présentoir, acier chromé
Soporte, acero cromado

art.	ø cm.	h.	bowls
44840-26	48	46	4xø20
Per ciotole/for bowls: 44837-20, 44837B20. Per ceste/for baskets: 42990-20, 42990M20, 42290N20.			



Supporto cromato
Serving stand, chrome plated
Serviergestell, hartverchromt
Présentoir, acier chromé
Soporte, acero cromado

art.	ø cm.	h.	bowls
44840-27	22	59	12xø6
44840-28	22	33	6xø6
Vasetti idonei - Suitable glasses: 41589C08, 41589C16, 41589-08, 41589-14, 41589-16. vedi pag./see page 285-286.			



Vasi Gourmet, set 12 pezzi
Gourmet glasses, 12 pcs.
Gourmet-Gläser, 12er Set
Set 12 verres Gourmet
Juego 12 vasos Gourmet

art.	ø cm.	h.	ml.
41589C08	6	5,5	80
41589C16	6	8,0	160
Adatti ai supporti - Suitable for stand: 44840-27 & 44840-28			

BAR HAPPY HOUR BUFFET BUFFET & PRESENTATION



Ciotola quadra, melamina
Square bowl, melamine
Schüssel, quadratisch, Melamin
Bol carré, melamine
Bol cuadrado, melamina

art.	dim. cm.	h.	col.
44847-09	9x9	4,0	bianco/white
44847-13	12,5x12,5	6,5	bianco/white
44847-20	19x19	9,0	bianco/white



Ciotola quadra, melamina
Square bowl, melamine
Schüssel, quadratisch, Melamin
Bol carré, melamine
Bol cuadrado, melamina

art.	dim. cm.	h.	col.
44847B09	9x9	4,0	nero/black
44847B13	12,5x12,5	6,5	nero/black
44847B20	19x19	9,0	nero/black



Piattino fingerfood, melamina
Party plate, melamine
Fingerfood-Teller, Melamin
Petit assiette, melamine
Platillo, melamina

art.	dim. cm.	h.	col.
44844-01	9,5x9,5	1,5/3,5	bianco/white
44844B01	9,5x9,5	1,5/3,5	nero/black



Vassoio, melamina
Tray, melamine
Tablett, Melamin
Plateau, melamine
Bandeja, melamina

art.	dim. cm.	h.
44844-11	53x32,5	2,5 GN1/1



Vassoio quadro, melamina
Tray, square, melamine
Tablett, quadratisch, Melamin
Plateau carré, melamine
Bandeja, cuadrada, melamina

art.	dim. cm.	col.
44841-18	18x18	bianco/white
44841-21	21x21	bianco/white
44841-26	26,5x26,5	bianco/white
44841-37	37x37	bianco/white
44841-51	51x51	bianco/white
44841B51	51x51	nero/black



Vassoio sushi, melamina
Sushi tray, melamine
Sushiplatte, Melamin
Plateau sushi, melamine
Bandeja sushi, melamina

art.	dim. cm.	col.
44842-31	31x10,5	bianco/white
44842-53	53x18	bianco/white
44842-35	35,5x18	bianco/white
44842-30	30x21	bianco/white
44842B53	53x18	nero/black
44842B31	31x10,5	nero/black



Vassoio GN 1/1, melamina
GN 1/1 tray, melamine
GN 1/1-Tablett, Melamin
Plateau GN 1/1, melamine
Bandeja GN 1/1, melamina

art.	dim. cm.	col.
44843-11	53x32,5	bianco/white
44843-12	32,5x26,5	bianco/white
44843-13	32,5x17,5	bianco/white
44843-14	26,5x16,2	bianco/white
44843B11	53x32,5	nero/black
44843B12	32,5x26,5	nero/black
44843B13	32,5x17,5	nero/black
44843B14	26,5x16,2	nero/black



Vassoio GN 2/4, melamina
GN 2/4 tray, melamine
GN 2/4-Tablett, Melamin
Plateau GN 2/4, melamine
Bandeja GN 2/4, melamina

art.	dim. cm.	col.
44843-24	53x16,2	bianco/white
44843B24	53x16,2	nero/black



Piatto tondo, melamina
Round dish, melamine
Platte, rund, Melamin
Plat rond, melamine
Bandeja redonda, melamina

art.	Ø cm.	col.
44845-51	51	bianco/white
44845-30	30	bianco/white
44845-41	41	bianco/white



Ciotola tonda, melamina
Round bowl, melamine
Schüssel, rund, Melamin
Bol ronde, melamine
Bol redondo, melamina

art.	Ø cm.	h.
44846B05	5,5	4,0
44846B09	9,0	4,5
44846B13	13,0	6,5
44846B15	15,0	7,5

BAR HAPPY HOUR BUFFET



Ciotola tonda, melamina
Round bowl, melamine
Schüssel, rund, Melamin
Bol ronde, melamine
Bol redondo, melamina

art.	ø cm.	h.
44846-05	5,5	4,0
44846-09	9,0	4,5
44846-13	13,0	6,5
44846-15	15,0	7,5



Portasalatini, melamina/inox
Relish dish, melamine/s-s
Salzgebäckständer, Melamin/Edelstahl
Porte-appetizers, melamine/inox
Soporte entremesas, melamina/inox

art.	dim. cm.	h.
44839-05	17x17	16



Tris zucchero, inox-melamina
Sugar stand, stainless steel-melamine
Zucker-Ständer, Edelmetall-Melamin
Tris sucrier, inox-melamine
Azucarero, inox- melamina

art.	dim. cm.	h.
44839-04	14x14	16



Ciotola, melamina
Bowl, melamine
Schale, Melamin
Bol, melamine
Bol, melamina

art.	dim. cm.	h.	lt.
44466-11	7,5x7	4,5	0,05



Ciotola, melamina
Bowl, melamine
Schale, Melamin
Bol, melamine
Bol, melamina

art.	dim. cm.	h.	lt.
44466-12	11,5x7,5	3	0,06



Ciotola, melamina
Bowl, melamine
Schale, Melamin
Bol, melamine
Bol, melamina

art.	dim. cm.	h.	lt.
44466-13	11,5x6	5,5	0,04



Ciotola, melamina
Bowl, melamine
Schale, Melamin
Bol, melamine
Bol, melamina

art.	dim. cm.	h.	lt.
44466-14	8,5x7	6	0,07



Ciotola, melamina
Bowl, melamine
Schale, Melamin
Bol, melamine
Bol, melamina

art.	dim. cm.	h.	lt.
44466-15	8x8	4	0,10



Ciotola, melamina
Bowl, melamine
Schale, Melamin
Bol, melamine
Bol, melamina

art.	dim. cm.	h.	lt.
44466-16	35x4,5	3	0,20



Cucchiaio finger-food, melamina
Party spoon, melamine
Finger-food-Löffel, Melamin
Cuiller, melamine
Cucharita, melamina

art.	dim. cm.	
44850-10	10x4,5	bianco/white
44850B10	10x4,5	nero/black



Cucchiaio finger-food, melamina
Party spoon, melamine
Finger-food-Löffel, Melamin
Cuiller, melamine
Cucharita, melamina

art.	dim. cm.	
44850-11	11x4,3	bianco/white
44850B11	10x4,5	nero/black



Cucchiaio finger-food, melamina
Party spoon, melamine
Finger-food-Löffel, Melamin
Cuiller, melamine
Cucharita, melamina

art.	dim. cm.	
44850-13	13,5x4,5	bianco/white
44850B13	13,5x4,5	nero/black



Cucchiaino finger-food, melamina
Party spoon, melamine
Finger-food-Löffel, Melamin
Cuiller, melamine
Cucharita, melamina

Fingerfood, melamina
Party spoon, melamine
Fingerfood Löffel, Melamin
Cuillère party, melamine
Cuchara party, melamina

Cucchiaino, melamina
Spoon, melamine
Löffel, Melamin
Cuiller, melamine
Cuchara, melamina

art.	dim. cm.	col.
44850-12	10x4,5x1	bianco/white
44850B12	10x4,5x1	nero/black
44850G12	10x4,5x1	verde/green

art.	dim. cm.	h.	col.
44851-01	14,5x4,5	4,5	bianco e nero - white & black
44851-02	14,5x4,5	4,5	bianco - white
44851-03	14,5x4,5	4,5	nero - black

art.	dim. cm.
44850-01	7x24



SAN



Set 6 cucchiaini
Spoon, 6 pcs set
Feinkostöffel, 6er set
Set 6 cuillères
Juego de 6 cucharas

Pirofila ovale, melamina
Bowl oval, melamine
Schale, oval, Melamin
Plat oval, melamine
Fuente ovale, melamina

art.	dim. cm.	col.
44850-00	6x23	trasp./clear
44850W00	6x23	bianco/white
44850B00	6x23	nero/black

art.	dim. cm.	h.	lt.
44849-27	27x17	4,0	0,8
44849-34	34x21	4,5	1,3
44849-47	47x29	5,0	3,2



Insalatiera, melamina
Bowl, melamine
Schüssel, Melamin
Saladier, melamine
Bol, melamina

Insalatiera, melamina
Bowl, melamine
Schüssel, Melamin
Saladier, melamine
Bol, melamina

Insalatiera, melamina
Bowl, melamine
Schüssel, Melamin
Saladier, melamine
Bol, melamina

art.	ø cm.	h.
44836-30	30	10

art.	ø cm.	h.
44836G30	30	10

art.	ø cm.	h.
44836B30	30	10



Piatto, melamina
Plate, melamine
Platte, Melamin
Plaque, melamine
Plato, melamina

Piatto, melamina
Plate, melamine
Platte, Melamin
Plaque, melamine
Plato, melamina

Piatto, melamina
Plate, melamine
Platte, Melamin
Plaque, melamine
Plato, melamina

art.	dim. cm.	h.
44835-36	36x16	3,0
44835-45	45x24	3,0
44835-53	53x29	3,5

art.	dim. cm.	h.
44835G36	36x16	3,0
44835G45	45x24	3,0
44835G53	53x29	3,5

art.	dim. cm.	h.
44835B36	36x16	3,0
44835B45	45x24	3,0
44835B53	53x29	3,5

BAR HAPPY HOUR BUFFET



Piatto, melamina
Plate, melamine
Platte, Melamin
Plaque, melamine
Plato, melamina

art.	dim. cm.	h.	Col.
44834-00	34,5x8	2,5	○
44834B00	34,5x8	2,5	●
44834G00	34,5x8	2,5	●



Piatto, melamina
Plate, melamine
Platte, Melamin
Plaque, melamine
Plato, melamina

art.	dim. cm.	h.
44836-35	34x35	4,5



Piatto, melamina
Plate, melamine
Platte, Melamin
Plaque, melamine
Plato, melamina

art.	dim. cm.	h.
44836G35	34x35	4,5



Piatto, melamina
Plate, melamine
Platte, Melamin
Plaque, melamine
Plato, melamina

art.	dim. cm.	h.
44836B35	34x35	4,5



Piatto, melamina
Plate, melamine
Platte, Melamin
Plaque, melamine
Plato, melamina

art.	dim. cm.	h.
44834-01	40x18,5	3,5
44834-02	52x25	4,0



Piatto, melamina
Plate, melamine
Platte, Melamin
Plaque, melamine
Plato, melamina

art.	dim. cm.	h.
44834G01	40x18,5	3,5
44834G02	52x25	4,0



Piatto, melamina
Plate, melamine
Platte, Melamin
Plaque, melamine
Plato, melamina

art.	dim. cm.	h.
44834B01	40x18,5	3,5
44834B02	52x25	4,0



Insalatiera, melamina
Bowl, melamine
Schüssel, Melamin
Saladier, melamine
Bol, melamina

art.	dim. cm.	h.	Col.
44834-03	40x18,5	10,0	○
44834G03	40x18,5	10,0	●
44834B03	40x18,5	10,0	●





Interno lucido, esterno satinato.

Mirror shiny inside, outside matt.



Ciotola, melamina
Bowl, melamine
Schüssel, Melamin
Bol, melamine
Bol, melamina

Ciotola, melamina
Bowl, melamine
Schüssel, Melamin
Bol, melamine
Bol, melamina

Ciotola, melamina
Bowl, melamine
Schüssel, Melamin
Bol, melamine
Bol, melamina

art.	dim. cm.	h.	lt.	col.
44449-32	32,5x17,5	10	1,8	○
44449B32	32,5x17,5	10	1,8	●

art.	dim. cm.	h.	lt.	col.
44449-30	30,5x30,5	10	3,3	○
44449B30	30,5x30,5	10	3,3	●

art.	dim. cm.	h.	lt.	col.
44449-33	33,5x33,5	13,5	3,8	○
44449B33	33,5x33,5	13,5	3,8	●



Piatto, melamina
Dish, melamine
Platte, Melamin
Plat, melamine
Bandeja, melamina

Ciotola, melamina
Bowl, melamine
Schüssel, Melamin
Bol, melamine
Bol, melamina

Ciotola, melamina
Bowl, melamine
Schüssel, Melamin
Bol, melamine
Bol, melamina

art.	dim. cm.	h.	col.
44448-18	18x10	3,5	○
44448-25	25x13,5	4,5	○
44448-30	30,5x17,5	5,0	○
44448B18	18x10	3,5	●
44448B25	25x13,5	4,5	●
44448B30	30,5x17,5	5,0	●

art.	dim. cm.	h.	col.
44447-10	10x13,5	6,0	○
44447-14	14,5x13,5	6,0	○
44447-18	18x16,5	6,5	○
44447B10	10x13,5	6,0	●
44447B14	14,5x13,5	6,0	●
44447B18	18x16,5	6,5	●

art.	dim. cm.	h.	col.
44446-10	10,5x10	6,5	○
44446-14	13,5x12,5	8,5	○
44446-18	17x16	10,5	○
44446B10	10,5x10	6,5	●
44446B14	13,5x12,5	8,5	●
44446B18	17x16	10,5	●



Vassoio, melamina
Tray, melamine
Tablett, Melamin
Plateau, melamine
Bandeja, melamina

art.	dim. cm.	h.	col.
44842-31	31x10,5	2	○
44842B31	31x10,5	2	●





Vassoio rettangolare, melamina
Tray, rectangular, melamine
Serviertablett, rechteckig, Melamin
Plateau rectangulaire, melamine
Bandeja rectangular, melamina

art.	dim. cm.	h.
44886-38	38,5x29,5	5
44886-44	44x34,5	5



Vassoio quadro, melamina
Tray, square, melamine
Tablett, quadratisch, Melamin
Plateau carré, melamine
Bandeja, cuadrada, melamina

art.	dim. cm.	h.
44886-30	30,5x30,5	4
44886-36	36x36	5



Ciotola, melamina
Bowl, melamine
Schüssel, Melamin
Bol, melamine
Bol, melamina

art.	dim. cm.	h.
44889-32	32,5x32,5	12,0
44889-35	35x35	12,5
44889-40	40x40	14,0



Ciotola, melamina
Bowl, melamine
Schüssel, Melamin
Bol, melamine
Bol, melamina

art.	dim. cm.	h.
44887-32	32x32	12,0
44887-36	36x36	12,5
44887-40	40x40	14,0



Ciotola, melamina
Bowl, melamine
Schüssel, Melamin
Bol, melamine
Bol, melamina

art.	ø cm.	h.
44888-32	32	16,5
44888-35	35	17,0
44888-40	40	17,5



Display per buffet, ABS
Buffet diplay
Büffetgestell
Etagère à buffet
Soporte platos pastre para buffet

art.	ø cm.	h.	
41868W00	50	21	bianco/white
41868K00	50	21	nero/black



Display per buffet, ABS
Buffet diplay
Büffetgestell
Etagère à buffet
Soporte platos pastre para buffet

art.	dim. cm.	h.	
41868W01	100x40	20	bianco/white
41868K01	100x40	20	nero/black



Display per buffet, ABS
Buffet diplay
Büffetgestell
Etagère à buffet
Soporte platos pastre para buffet

art.	dim. cm.	h.	
41868W02	70x43	14	bianco/white
41868K02	70x43	14	nero/black



Display per buffet, ABS
Buffet diplay
Büffetgestell
Etagère à buffet
Soporte platos pastre para buffet

art.	ø cm.	h.	
41868W05	56	57	bianco/white
41868K05	56	57	nero/black



Display per buffet, ABS
Buffet diplay
Büffetgestell
Etagère à buffet
Soporte platos pastre para buffet

art.	ø cm.	h.	
41868W03	56	57	bianco/white
41868K03	56	57	nero/black



Display per buffet, PS
Buffet diplay
Büffetgestell
Etagère à buffet
Soporte platos pastre para buffet

art.	ø cm.	h.	
41868-04	56	57	bianco/white

Struttura in metallo verniciato a polvere. - Metal structure powder painted.



Display per buffet, plexiglas
Buffet display
Büffetgestell
Etagère à buffet
Soporte platos pastre para buffet

art.	dim. cm.	h.
41866-04	25x25	25-18-11-4



Display per buffet, plexiglas
Buffet display
Büffetgestell
Etagère à buffet
Soporte platos pastre para buffet

art.	dim. cm.	ripiani/shelves
41870-01	54x47x63	47x34 - 37x25 27x17 - 23x13



Display per buffet, plexiglas
Buffet display
Büffetgestell
Etagère à buffet
Soporte platos pastre para buffet

art.	dim. cm.	ripiani/shelves
41870-02	40x40 h. 53	40x40 - 30x30 22x22-27x17 - 23x13



Display per buffet, plexiglas
Buffet display
Büffetgestell
Etagère à buffet
Soporte platos pastre para buffet

art.	ripiani/shelves
41870-03	ø28 h.29 - 38x30 h.21 38x30 h.13 - 38x30 h.5



Display per buffet, plexiglas
Buffet display
Büffetgestell
Etagère à buffet
Soporte platos pastre para buffet

art.	ripiani/shelves
41870-04	40x27 h.29 - 40x27 h.21 40x27 h.13 - 40x27 h.5

Gambe in acciaio verniciato a polvere. - Legs powder painted.

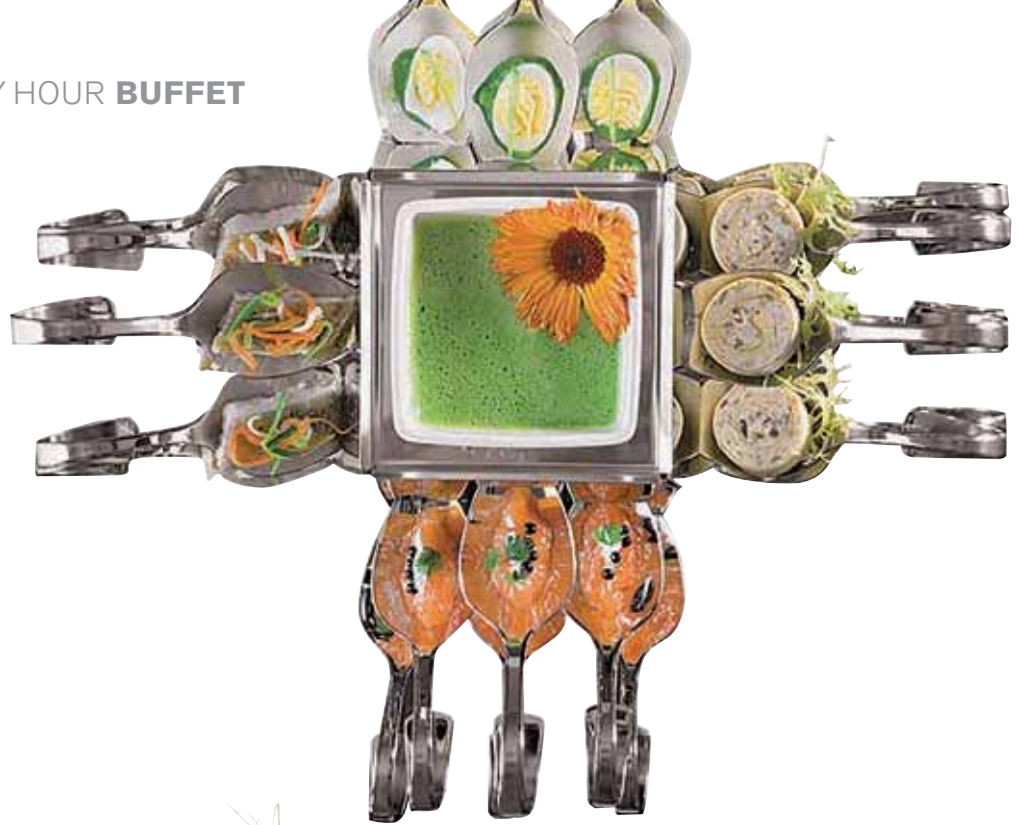

Piramide , inox
Pyramid, stainless steel
Pyramide, Edelstahl
Pyramide, inox
Pirámide, inox

art.	dim. cm.	h.
42988-03	30x30	53

Set composto da: 1 piatto in inox rotante, 1 vassoio in melamina (51x51 cm), 1 ciotola inox (11x11 cm), 108 cucchiaini e 200 spiedini. - Set of: 1 s/s rotating plate, 1 melamine tray (51x51 cm), 1 s/s bowl (11x11 cm), 108 party spoons and 200 skewers.

Piramide , inox
Pyramid, stainless steel
Pyramide, Edelstahl
Pyramide, inox
Pirámide, inox

art.	dim. cm.	h.
42988-02	22x22	31

Set composto da: 1 piatto in inox rotante, 1 vassoio in melamina (37x37 cm), 1 ciotola inox (11x11 cm.), 48 cucchiaini e 70 spiedini. - Set of: 1 s/s rotating plate, 1 melamine tray (37x37 cm), 1 s/s bowl (11x11 cm), 48 party spoons and 70 skewers

Piramide , inox
Pyramid, stainless steel
Pyramide, Edelstahl
Pyramide, inox
Pirámide, inox

art.	dim. cm.	h.
42988-01	17x17	17

Set composto da: 1 ciotola inox (11x11 cm), 24 cucchiaini e 20 spiedini. - Set of: 1 s/s bowl (11x11 cm), 24 party spoons and 20 skewers.



Display triangolo , inox
Triangle display, stainless steel
Dreieck-Display, Edelstahl
Display triangle, inox
Display triángulo, inox

art.	dim. cm.	h.
42988-00	21,5x14	27

Set composto da: 12 cucchiaini e 20 spiedini. - Set of: 12 party spoons and 20 skewers.

Cucchiaino gourmet, inox
Party spoon, stainless steel
Gourmet-Löffel, Edelstahl
Cuiller gourmet, inox
Cuchara gourmet, inox

art.	l. cm.	col.
42988-99	13,5	inox - s/s
42988C99	12,0	rame - copper
42988G99	12,0	oro - gold





Espositore 3 piani, PMMA
Tier display, PMMA
Stufen-Display, PMMA
Présentoir 3 niveaux, PMMA
Expositor 3 niveles, PMMA

art.	dim. cm.	h.
41919-03	40x18	4
	40x20	8
	40x22	12



Alzata
Stand
Ständer
Support
Soporte

art.	h. cm.
44840-30	8
44840-31	12
44840-32	18

Metallo con rivestimento antiscivolo nero.
Lavabile in lavastoviglie. - Metal with black
anti-slip coating. Dishwasher safe.



Alzata
Stand
Ständer
Support
Soporte



art.	ø cm.	h.
44840-40	15,5-18	8
44840-41	15,5-18	10
44840-42	15,5-18	18

Metallo con rivestimento antiscivolo
nero. Lavabile in lavastoviglie.
Metal with black anti-slip coating.
Dishwasher safe.



Cesto
Basket
Korb
Panier
Cesta

art.	ø cm.	h.
44476-20	21-16,5	21



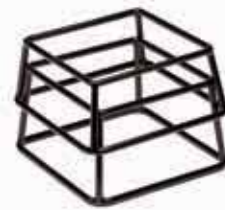
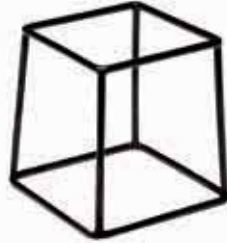
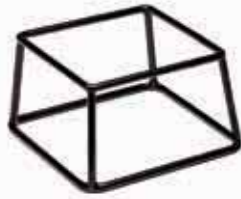

Alzata
Stand
Ständer
Support
Soporte

art.	dim. cm.	h.
44840-08	18x18	8
44840-10	18x18	10
44840-18	18x18	18

Metallo con rivestimento antiscivolo nero. Lavabile in lavastoviglie.
Metal with black anti-slip coating. Dishwasher safe.

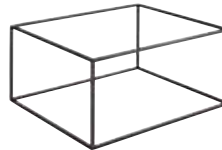

Alzata
Stand
Ständer
Support
Soporte



art.	dim. cm.	GN
44840-50	53x32,5-53x16,5	1/1- 2/4
44840-51	32,5x26,5-26,5x16,2	1/2-1/4
44840-52	32,5x17,5-35,4x32,5	1/3-2/3

Cromato. - Chromed.



Alzata
Stand
Ständer
Support
Soporte



art.	dim. cm.	GN
44840-55	53x32,5-53x16,5	1/1- 2/4
44840-56	32,5x26,5-26,5x16,2	1/2-1/4
44840-57	32,5x17,5-35,4x32,5	1/3-2/3

Rivestimento nero. - Black coating.



Alzata
Stand
Ständer
Support
Soporte

art.	ø cm.	h.
44840-60	20,5-16,5	20

Specchiato. - Polished.

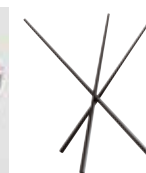

Alzata
Stand
Ständer
Support
Soporte

art.	ø cm.	h.
44840-61	20,5-16,5	20

Rivestimento nero. - Black coating.

**BAR HAPPY HOUR BUFFET
BUFFET & PRESENTATION**



Alzata/cesto, inox
Stand/basket, stainless steel
Ständer/Korb, Edelstahl Rostfrei
Support/panier, inox
Soporte/cesta, inox

art. ø cm. h.
44476-24 15 10,5



Alzata/cesto, inox
Stand/basket, stainless steel
Ständer/Korb, Edelstahl Rostfrei
Support/panier, inox
Soporte/cesta, inox

art. ø cm. h.
44476-25 15 10,5

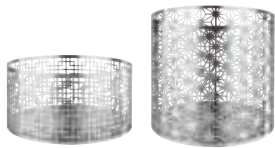

Alzata/cesto, inox
Stand/basket, stainless steel
Ständer/Korb, Edelstahl Rostfrei
Support/panier, inox
Soporte/cesta, inox

art. ø cm. h.
44476-26 21 10,5
44476-28 21 20,0



Alzata/cesto, inox
Stand/basket, stainless steel
Ständer/Korb, Edelstahl Rostfrei
Support/panier, inox
Soporte/cesta, inox

art. ø cm. h.
44476-27 21 10,5
44476-29 21 20,0



Alzata/cesto
Stand/basket
Ständer/Korb
Support/panier
Soporte/cesta

art. ø cm. h.
44476-30 15 10,5
44476-31 21 20,0



Alzata/cesto
Stand/basket
Ständer/Korb
Support/panier
Soporte/cesta

art. ø cm. h.
44476-32 15 10,5
44476-33 21 20,0

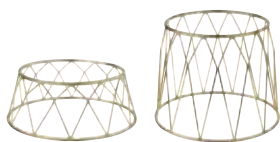

Alzata
Stand
Ständer
Support
Soporte

art. ø cm. h. col.
44476-36 20-25 10,0 oro/gold
44476-37 20-25 19,5 oro/gold

Metallo con rivestimento antiscivolo.
Metal, with anti-sliding coating.

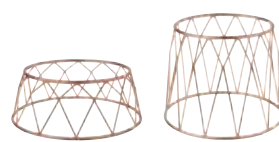

Alzata
Stand
Ständer
Support
Soporte

art. ø cm. h. col.
44476-38 20-25 10,0 rame/copper
44476-39 20-25 19,5 rame/copper

Metallo con rivestimento antiscivolo.
Metal, with anti-sliding coating.



Quasi tutti i prodotti hanno un sistema di anelli e raggi che permettono di combinarli l'un l'altro stabilmente. Per esempio, tutte le ciotole possono essere utilizzate come alzate per una vasta gamma di altri prodotti. Lo stesso vale per i cesti - Nearly all products feature a system of rings and rays that allow them to be combined with each other in a stable manner. For example, all bowls can be used as risers for a wide range of other products. The same applies to the baskets.



Ciotola, melamina
Bowl, melamine
Schüssel, Melamin
Bol, melamine
Bol, melamina

art.	ø cm.	h.	lt.
44477-00	7,5	3,5	0,06
44477-01	9,5	4,5	0,13
44477-02	13,0	5,5	0,35
44477-03	16,0	7,0	0,60
44477-04	20,0	8,0	1,10
44477-05	24,0	9,5	2,20
44477-06	26,5	11,0	3,00
44477-07	32,5	12,5	5,40



Ciotola, melamina
Bowl, melamine
Schüssel, Melamin
Bol, melamine
Bol, melamina

art.	ø cm.	h.	lt.
44477-08	7,5	3,5	0,06
44477-09	9,5	4,5	0,13
44477-10	13,0	5,5	0,35
44477-11	16,0	7,0	0,60
44477-12	20,0	8,0	1,10
44477-13	24,0	9,5	2,20
44477-14	26,5	11,0	3,00
44477-15	32,5	12,5	5,40



Ciotola, melamina
Bowl, melamine
Schüssel, Melamin
Bol, melamine
Bol, melamina

art.	ø cm.	h.	lt.
44477-16	7,5	3,5	0,06
44477-17	9,5	4,5	0,13
44477-18	13,0	5,5	0,35
44477-19	16,0	7,0	0,60
44477-20	20,0	8,0	1,10
44477-21	24,0	9,5	2,20
44477-22	26,5	11,0	3,00
44477-23	32,5	12,5	5,40



Coperchio con spacco cucchiaio, SAN
Lid with notch
Deckel mit Löffelaussparung
Couverture avec écart pour cuillère
Tapa con corte para cuchara

art.	ø cm.	h.
44475-41	16,0	1,5
44475-42	20,0	1,5
44475-43	24,0	1,5
44475-44	26,5	1,5
44475-45	32,5	1,5



Piatto, melamina
Plate, melamine
Teller, Melamin
Assiette, melamine
Plato, melamina

art.	ø cm.	h.
44477-24	11,0	2
44477-25	16,0	2
44477-26	19,5	2
44477-27	24,0	2
44477-28	28,0	2



Piatto, melamina
Plate, melamine
Teller, Melamin
Assiette, melamine
Plato, melamina

art.	ø cm.	h.
44477-29	11,0	2
44477-30	16,0	2
44477-31	19,5	2
44477-32	24,0	2
44477-33	28,0	2



Piatto, melamina
Plate, melamine
Teller, Melamin
Assiette, melamine
Plato, melamina

art.	ø cm.	h.
44477-34	11,0	2
44477-35	16,0	2
44477-36	19,5	2
44477-37	24,0	2
44477-38	28,0	2



Ciotola, melamina
Bowl, melamine
Schüssel, Melamin
Bol, melamine
Bol, melamina

art.	ø cm.	h.	lt.
44477-40	7,5	3,0	0,04
44477-41	7,5	6,5	0,13
44477-42	15,5	3,0	0,13
44477-43	15,5	6,5	0,60
44477-44	23,0	3,0	0,40
44477-45	23,0	6,5	1,60



Ciotola, melamina
Bowl, melamine
Schüssel, Melamin
Bol, melamine
Bol, melamina

art.	ø cm.	h.	lt.
44477-46	7,5	3,0	0,04
44477-47	7,5	6,5	0,13
44477-48	15,5	3,0	0,13
44477-49	15,5	6,5	0,60
44477-50	23,0	3,0	0,40
44477-51	23,0	6,5	1,60



Ciotola, melamina
Bowl, melamine
Schüssel, Melamin
Bol, melamine
Bol, melamina

art.	dim. cm.	h.	lt.
44477-52	7,5x7,5	3,0	0,05
44477-53	7,5x7,5	6,5	0,16
44477-54	15,5x15,5	3,0	0,19
44477-55	15,5x15,5	6,5	0,85
44477-56	23x23	3,0	0,45
44477-57	23x23	6,5	2,00



Ciotola, melamina
Bowl, melamine
Schüssel, Melamin
Bol, melamine
Bol, melamina

art.	dim. cm.	h.	lt.
44477-58	7,5x7,5	3,0	0,05
44477-59	7,5x7,5	6,5	0,16
44477-60	15,5x15,5	3,0	0,19
44477-61	15,5x15,5	6,5	0,85
44477-62	23x23	3,0	0,45
44477-63x	23x23	6,5	2,00



Ciotola, melamina
Bowl, melamine
Schüssel, Melamin
Bol, melamine
Bol, melamina

Ciotola, melamina
Bowl, melamine
Schüssel, Melamin
Bol, melamine
Bol, melamina

Vassoio, melamina
Tray, melamine
Tablett, Melamin
Plateau, melamine
Bandeja, melamina

Vassoio, melamina
Tray, melamine
Tablett, Melamin
Plateau, melamine
Bandeja, melamina

art.	dim. cm.	h.	lt.
44477-64	15,5x7,5	3,0	0,10
44477-65	15,5x7,5	6,5	0,40
44477-66	15,5x9,5	3,0	0,15
44477-67	15,5x9,5	6,5	0,50
44477-68	25x15,5	3,0	0,30
44477-69	25x15,5	6,5	1,40

art.	dim. cm.	h.	lt.
44477-70	15,5x7,5	3,0	0,10
44477-71	15,5x7,5	6,5	0,40
44477-72	15,5x9,5	3,0	0,15
44477-73	15,5x9,5	6,5	0,50
44477-74	25x15,5	3,0	0,30
44477-75	25x15,5	6,5	1,40

art.	dim. cm.	h.	GN
44477-76	53x32,5	3	1/1
44477-77	32,5x26,5	3	1/2
44477-78	32,5x17,6	3	1/3
44477-79	26,5x16,2	3	1/4
44477-80	35,4x32,5	3	2/3
44477-81	53x16,2	3	2/4

art.	dim. cm.	h.	GN
44477-82	53x32,5	3	1/1
44477-83	32,5x26,5	3	1/2
44477-84	32,5x17,6	3	1/3
44477-85	26,5x16,2	3	1/4
44477-86	35,4x32,5	3	2/3
44477-87	53x16,2	3	2/4

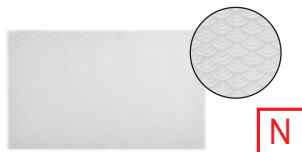

N

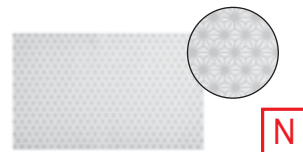

N

Tappeto antiscivolo, silicone
Non slip mat, silicone
Antirutschmatte Silikon
Tapis anti-dérapant, silicone
Tapete antideslizante, silicona

Tappeto antiscivolo, silicone
Non slip mat, silicone
Antirutschmatte Silikon
Tapis anti-dérapant, silicone
Tapete antideslizante, silicona

art.	dim. cm.	per/for
44099-10	51x31	GN 1/1
44099-11	31x25,5	GN 1/2

art.	dim. cm.	per/for
44099-20	51x31	GN 1/1
44099-21	31x25,5	GN 1/2





Ciotola tonda, melamina
Round bowl, melamine
Schüssel, rund, Melamin
Bol rond, melamine
Bol redondo, melamina

art.	ø cm.	h.	lt.
44475-01	6,5	6,0	0,10
44475-02	9,0	3,5	0,07
44475-03	13,0	7,0	0,60
44475-04	16,0	12,0	1,50
44475-05	16,0	15,0	2,00
44475-06	20,0	7,0	1,50
44475-07	24,0	9,0	2,70
44475-08	26,5	9,0	3,00
44475-09	32,5	9,0	4,00



Ciotola quadrata, melamina
Square bowl, melamine
Schüssel, viereckig, Melamin
Bol carré, melamine
Bol cuadrado, melamina

art.	dim. cm.	h.	lt.
44475-10	6,5x6,5	6,0	0,15
44475-11	9x9	3,5	0,15
44475-12	13x13	7,0	0,70
44475-13	20x20	7,0	1,50
44475-14	24x24	9,0	3,50
44475-15	26,5x26,5	9,0	4,00



Ciotola rettangolare, melamina
Rectangular bowl, melamine
Schüssel, rechteckig, Melamin
Bol rectangulaire, melamine
Bol rectangular, melamina

art.	dim. cm.	h.	lt.
44475-16	26,5x16,2	7	1,5
44475-17	26,5x16,2	9	2,5



Ciotola tonda, melamina
Round bowl, melamine
Schüssel, rund, Melamin
Bol rond, melamine
Bol redondo, melamina

art.	ø cm.	h.	lt.
44475-18	13,0	7	0,6
44475-19	20,0	7	1,5
44475-20	24,0	9	2,7
44475-21	26,5	9	3,0
44475-22	32,5	9	4,0



Ciotola tonda, melamina
Round bowl, melamine
Schüssel, rund, Melamin
Bol rond, melamine
Bol redondo, melamina

art.	ø cm.	h.	lt.
44475-23	20	7	1,5



Ciotola tonda, melamina
Round bowl, melamine
Schüssel, rund, Melamin
Bol rond, melamine
Bol redondo, melamina

art.	ø cm.	h.	lt.
44475-24	32,5	9	4



Ciotola quadrata, melamina
Square bowl, melamine
Schüssel, viereckig, Melamin
Bol carré, melamine
Bol cuadrado, melamina

art.	dim. cm.	h.	lt.
44475-25	13x13	7	0,7
44475-26	20x20	7	1,5
44475-27	24x24	9	3,5
44475-28	26,5x26,5	9	4,0



Ciotola quadrata, melamina
Square bowl, melamine
Schüssel, viereckig, Melamin
Bol carré, melamine
Bol cuadrado, melamina

art.	dim. cm.	h.	lt.
44475-29	20x20	7	1,5



Ciotola tonda, melamina
Round bowl, melamine
Schüssel, rund, Melamin
Bol rond, melamine
Bol redondo, melamina

Ciotola quadrata, melamina
Square bowl, melamine
Schüssel, viereckig, Melamin
Bol carré, melamine
Bol cuadrado, melamina

art.	ø cm.	h.	lt.
44475-35	6,5	6,0	0,10
44475-36	9,0	3,5	0,07
44475-37	16,0	12,0	1,50
44475-38	16,0	15,0	2,00

art.	dim. cm.	h.	lt.
44475-39	6,5x6,5	6,0	0,15
44475-40	9x9	3,5	0,15



Ciotola quadrata, melamina
Square bowl, melamine
Schüssel, viereckig, Melamin
Bol carré, melamine
Bol cuadrado, melamina

Ciotola rettangolare, melamina
Rectangular bowl, melamine
Schüssel, rechteckig, Melamin
Bol rectangulaire, melamine
Bol rectangular, melamina

Ciotola rettangolare, melamina
Rectangular bowl, melamine
Schüssel, rechteckig, Melamin
Bol rectangulaire, melamine
Bol rectangular, melamina

Ciotola rettangolare, melamina
Rectangular bowl, melamine
Schüssel, rechteckig, Melamin
Bol rectangulaire, melamine
Bol rectangular, melamina

art.	dim. cm.	h.	lt.
44475-30	26,5x26,5	9	4

art.	dim. cm.	h.	lt.
44475-31	26,5x16,2	7	1,5
44475-32	26,5x16,2	9	2,5

art.	dim. cm.	h.	lt.
44475-33	26,5x16,2	7	1,5

art.	dim. cm.	h.	lt.
44475-34	26,5x16,2	9	2,5



Coperchio con spacco cucchiaio, SAN
Lid with notch
Deckel mit Löffelaussparung
Couvercle avec écart pour cuillère
Tapa con corte para cuchara

Coperchio con spacco cucchiaio, SAN
Lid with notch
Deckel mit Löffelaussparung
Couvercle avec écart pour cuillère
Tapa con corte para cuchara

Coperchio con spacco cucchiaio, SAN
Lid with notch
Deckel mit Löffelaussparung
Couvercle avec écart pour cuillère
Tapa con corte para cuchara

art.	ø cm.	h.
44475-41	16,0	1,5
44475-42	20,0	1,5
44475-43	24,0	1,5
44475-44	26,5	1,5
44475-45	32,5	1,5

art.	dim. cm.	h.
44475-46	20x20	1,5
44475-47	24x24	1,5
44475-48	26,5x26,5	1,5

art.	dim. cm.	h.
44475-49	26,5x16,2	1,5

N MF  **LOTUS**



Mosaico di melamina - ispirato alle foglie del fior di loto, consente la presentazione individuale di creazioni culinarie. Può essere utilizzato in combinazione con tre ciotole a forma di fiore. - **Melamine mosaic - inspired by the leaves of the lotus flower, these products enable individual presentation of culinary creations. They can be combined with three flower bowls.**



Piatto, melamina
Plate, melamine
Platte, Melamin
Plat, melamine
Plato, melamina

art.	ø cm.	h.	col.
44475-51	46,5	2,5	○
44475-52	46,5	2,5	●
44475-53	46,5	2,5	●



Piatto, melamina
Plate, melamine
Platte, Melamin
Plat, melamine
Plato, melamina

art.	ø cm.	h.	col.
44475-54	17,5	2,5	○
44475-55	17,5	2,5	●
44475-56	17,5	2,5	●
44475-57	17,5	2,5	●



Piatto, melamina
Plate, melamine
Platte, Melamin
Plat, melamine
Plato, melamina

art.	dim. cm.	h.	col.
44475-58	15x8,5	2,5	○
44475-59	15x8,5	2,5	●
44475-60	15x8,5	2,5	●
44475-61	15x8,5	2,5	●



Ciotola, melamina
Square, melamine
Schüssel, Melamin
Bol, melamine
Bol, melamina

art.	ø cm.	h.	lt.
44475-62	8,5	4	0,1
44475-63	13,0	6	0,3
44475-64	20,0	7	1,2



Ciotola, melamina
Square, melamine
Schüssel, Melamin
Bol, melamine
Bol, melamina

art.	ø cm.	h.	lt.
44475-65	8,5	4	0,1
44475-66	13,0	6	0,3
44475-67	20,0	7	1,2



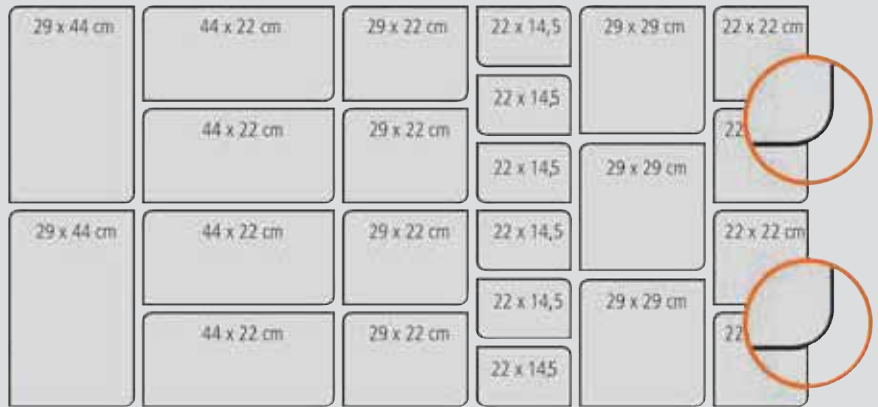

Sistema composto da 30 vassoi espositori, nei colori bianco e nero. Disponibili 5 coperchi trasparenti in SAN idonei ad ogni formato. Un flessibile sistema modulare per banchi con profondità 70-90 cm, nessuno spazio vuoto nel bancone, diverse capacità e design uniforme. Il bordo stabile permette di impilare i contenitori facilmente e velocemente, niente più graffi o contenitori inceppati.

System consist of 30 bowls and trays each in black and white color. Properly to the bowls 5 transparent SAN covers are available. Advantages: flexible modular system for counter depth 70 to 90 cm, no gap inside the counter, variable filling quantities and uniform design. The stable edge allows an easy and fast stack and therefore no scratching or jamming of the bowls.



Bianco - White

Vassoio espositore, melamina
Display tray, melamine
Theke-Ausstellplatte, Melamin
Plateau de comptoir, melamine
Bandeja expositora, melamina

art.	dim. cm.	h.	lt.
42582-01	22x14,5	2	
42582-02	22x14,5	4	0,7
42582-03	22x14,5	6	1,0
42582-04	22x14,5	9	1,7
42582-05	22x22	4	1,0
42582-06	22x22	6	1,8
42582-07	22x22	9	3,0
42582-08	29x22	4	1,3
42582-09	29x22	6	2,1
42582-10	29x29	2	
42582-11	29x29	4	1,5
42582-12	29x29	6	3,0
42582-13	44x22	2	
42582-14	44x22	4	2,0
42582-15	44x29	2	

Nero - Black

Vassoio espositore, melamina
Display tray, melamine
Theke-Ausstellplatte, Melamin
Plateau de comptoir, melamine
Bandeja expositora, melamina

art.	dim. cm.	h.	lt.
42582B01	22x14,5	2	
42582B02	22x14,5	4	0,7
42582B03	22x14,5	6	1,0
42582B04	22x14,5	9	1,7
42582B05	22x22	4	1,0
42582B06	22x22	6	1,8
42582B07	22x22	9	3,0
42582B08	29x22	4	1,3
42582B09	29x22	6	2,1
42582B10	29x29	2	
42582B11	29x29	4	1,5
42582B12	29x29	6	3,0
42582B13	44x22	2	
42582B14	44x22	4	2,0
42582B15	44x29	2	



Cucchiaino servire, melamina
Serving-spoon, melamine
Servier-Löffel, Melamin
Cuillère, melamine
Cuchara, melamina

art.	dim. cm.	l.	
44852-01	7x6,5	26,5	bianco - white
44852-02	7x6,5	26,5	nero - black

Coperchio con spacco cucchiaino
Lid with notch
Deckel mit Löffelaussparung
Couvercle avec écart pour cuillère
Tapa con corte para cuchara

art.	dim. cm.
42582-21	22x14,5
42582-22	22x22
42582-23	29x22
42582-24	29x29
42582-25	44x22

Set 6 cucchiaini
Spoon, 6 pcs set
Feinkostöffel, 6er set
Set 6 cuillères
Juego de 6 cucharas

art.	dim. cm.	col.
44850-00	6x23	trasp./clear
44850W00	6x23	bianco/white
44850B00	6x23	nero/black

SPECCHI ACRILICI-PMMA ACRYLIC-PMMA MIRRORS



Specchio acrilico, quadrato
Acrylic mirror, square
Acryl-Spiegel, quadratisch
Miroir acrylique, carré
Espejo acrílico, cuadra

art.	dim. cm.
41885-30	30x30
41885-40	40x40
41885-45	45x45
41885-50	50x50
41885-60	60x60



Specchio acrilico, ovale
Acrylic mirror, oval
Acryl-Spiegel, oval
Miroir acrylique, ovale
Espejo acrílico, oval

art.	dim. cm.
41877-45	45x30
41877-61	61x45,5
41877-81	81x61
41877-99	100x70



Specchio acrilico, rettangolare
Acrylic mirror, rectangular
Acryl-Spiegel, rechteckig
Miroir acrylique, rectangulaire
Espejo acrílico, rectangular

art.	dim. cm.
41878-45	45x30
41878-61	61x46
41878-81	81x58,5
41878-99	100x70



Specchio acrilico, ottagonò
Acrylic mirror, octagon
Acryl-Spiegel, Achteck
Miroir acrylique, octogone
Espejo acrílico, octágono

art.	ø cm.
41879-30	30
41879-40	40
41879-50	50
41879-61	61



Specchio acrilico, virgola
Acrylic mirror, comma
Acryl-Spiegel, Komma
Miroir acrylique, virgule
Espejo acrílico, virgula

art.	ø cm.
41875-40	40,6
41875-61	61,0



Specchio acrilico, cerchio
Acrylic mirror, circle
Acryl-Spiegel, Kreis
Miroir acrylique, cercle
Espejo acrílico, aro

art.	ø cm.
41876-30	30,5
41876-38	38,0
41876-45	45,0
41876-58	58,0



Specchio acrilico, esagonò
Acrylic mirror, hexagon
Acryl-Spiegel, Sechseck
Miroir acrylique, hexagon
Espejo acrílico, hexágono

art.	ø cm.
41880-38	38
41880-61	61



Specchio acrilico, spicchio
Acrylic mirror, segment
Acryl-Spiegel, Segment
Miroir acrylique, quartier
Espejo acrílico, segmento

art.	ø cm.
41881-30	30,5
41881-40	40,5



Specchio acrilico, cubò
Acrylic mirror, cube
Acryl-Spiegel, Würfel
Miroir acrylique, cube
Espejo acrílico, cubò

art.	dim. cm.
41882-15	15x15x15
41882-20	20x20x20
41882-25	25x25x25
41882-30	30x30x30



Stand per vassoi, cromato
Tray stand, chromed
Tablett-Träger, verchromt
Porte plateaux, chromé
Soporte para bandejas, cromado

art.	dim. cm.	h.
44093-00	38x 48	74



Stand per vassoi, legno
Tray stand, wood
Tablett-Träger, Holz
Porte plateaux, bois
Soporte para bandejas, madera

art.	dim. cm.	h.
44093-01	42x43	82



Portagiornale, legno
Newspaper stick, wood
Zeitungshalter aus Holz
Canne à journaux, bois
Varilla portaperiodico, madera

art.	l. cm.	col.
48287-18	75	chiaro - light
48287-19	75	scuro - dark



Vassoio rettangolare, PP
Tray, rectangular, PP
Serviertablett, rechteckig, PP
Plateau rectangulaire, PP
Bandeja rectangular, PP

art.	dim. cm.
41860-36	27x36,5
41860-43	30,7x43,5
41860-47	35,5x47



Vassoio rettangolare, PP
Tray, rectangular, PP
Serviertablett, rechteckig, PP
Plateau rectangulaire, PP
Bandeja rectangular, PP

art.	dim. cm.
41861-44	30,7x44



Vassoio room service, noce
Room service tray, walnut
Zimmerservice-Tablett, Nussbraun
Plateau room-service, noyer
Bandeja roo service, nuez

art.	dim. cm.
19901-35	52x35
19901-40	60x40
19901-47	71x47

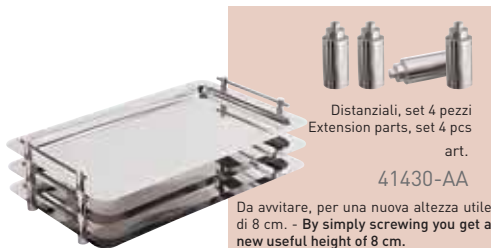

Distanziali, set 4 pezzi
Extension parts, set 4 pcs
art.

41430-AA

Da avvitare, per una nuova altezza utile di 8 cm. - By simply screwing you get a new useful height of 8 cm.



Vassoio impilabile, inox
Tray, stackable, stainless steel
Tablett, stapelbar, Edelstahl Rostfrei
Plateau empilable, inox
Bandeja apilable, acero inox

art.	dim. cm.	h.	GN
41430-11	53x32,5	5	1/1

Maniglie cromate. Altezza utile 4 cm.
Chrome plated handles. Useful height 4 cm.

Vassoio, inox
Tray, stainless steel
Tablett, Edelstahl Rostfrei
Plateau, inox
Bandeja, inox

art.	dim. cm.	GN
41436-11	53x32,5	1/1
41436-12	32,5x26,5	1/2



BAR HAPPY HOUR BUFFET



Vassoio bordo Deko, inox
Tray, deko-edge, stainless steel
Tablett, Dekorrand, Edelstahl Rostfrei
Plateau avec décor, inox
Bandeja, borde decorado, inox

art.	dim. cm.	GN
41437-11	53x32,5	1/1
41437-12	32,5x26,5	1/2



Vassoio ovale, bordo Deko, inox
Oval tray, deko-edge, stainless steel
Tablett, oval, Dekorrand, Edelstahl
Plateau oval avec décor, inox
Bandeja oval, borde decorado, inox

art.	dim. cm.
41438-50	50x36
41438-60	60x41
41438-70	70x46



Vassoio pesce, inox
Fish tray, stainless steel
Fischplattlet, Edelstahl Rostfrei
Plat à poisson, inox
Salmonera, inox

art.	dim. cm.
41655-66	66x22,5



Vassoio, bordo Deko, inox
Tray, deko-edge, stainless steel
Tablett, Dekorrand, 18/10 Edelstahl
Plateau avec décor, inox
Bandeja, borde decorado, inox

art.	ø cm.
41439-32	32
41439-38	38
41439-48	48



Vassoio ovale con bordo, inox
Oval meat dish with rim, stainless steel
Gebördelte Bratenplatte, oval, Edelstahl
Plat à rôti ovale, bord roulé, inox
Bandeja oval, borde vuelto, inox

art.	dim. cm.
41651-20	20x14
41651-25	25x18
41651-30	30x22
41651-35	35x22
41651-40	40x26



Vassoio ovale con bordo, inox
Oval meat dish with rim, stainless steel
Gebördelte Bratenplatte, oval, Edelstahl
Plat à rôti ovale, bord roulé, inox
Bandeja oval, borde vuelto, inox

art.	dim. cm.
41651-45	45x29
41651-50	50x35
41651-55	55x38
41651-60	60x42
41651-65	65x45



Vassoio tondo, inox
Tray, round, stainless steel
Tablett, rund, 18-10 Edelstahl
Plateau rond, inox
Bandeja redonda, inox

art.	ø cm.
66326-30	30
66326-35	35
66326-40	40
66326-60	60
66326-80	80



Piatto pesce, inox
Fish dish, stainless steel
Fischplatte, 18-10 Edelstahl
Plat à poisson, inox
Bandeja pescado, inox

art.	dim. cm.
66345-55	55x23
66345-65	65x27
66345-74	74x29



Vassoio pesce, inox
Fish tray, stainless steel
Fischplatte, Edelstahl Rostfrei
Plat à poisson, inox
Bandeja pescado, inox

art.	dim. cm.
41654-80	80x31
41654-99	100x35



Vassoio ovale, inox
Tray, oval, stainless steel
Tablett, oval, 18-10 Edelstahl
Plateau ovale, inox
Bandeja oval, inox

art.	dim. cm.
66325-30	30x19
66325-35	35x22
66325-41	41x26
66325-46	46x29
66325-54	54x37
66325-85	85x58
66325-99	100x68



Vassoio, inox
Tray, stainless steel
Tablett, 18-10 Edelstahl
Plateau, inox
Bandeja, inox

art.	dim. cm.
66320-28	28x20
66320-35	35x30
66320-40	40x26
66320-50	50x38
66320-65	65x50
56020-85	85x50
56020-99	100x50



Vassoio, inox
Tray, stainless steel
Tablett, 18-10 Edelstahl
Plateau, inox
Bandeja, inox

art.	dim. cm.
66324-40	40x26
66324-50	50x38
66324-65	65x50
56024-85	85x50
56024-99	100x50

Frame BuffetSystem

by Michael Sieger / sieger design

Gli elementi che compongono il sistema sono modulari, rendendo la composizione estremamente versatile. La natura impilabile di ogni elemento consente uno stoccaggio efficiente, ottimizzando lo spazio. Le strutture porta ciotole sono impilabili sia senza che con le ciotole. Tutti gli elementi del sistema sono veloci e semplici da utilizzare, facili da impugnare sotto gli inserti (tagliere, inserto porta ciotole, vassoi, ecc.) come pure sotto la base dei moduli stessi anche quando sono impilati. Le strutture in acciaio inox ad esempio possono essere utilizzate anche senza inserti come letto per contenere ghiaccio per la presentazione di composizioni di frutti di mare o altri alimenti. Le strutture porta ciotole in acciaio inox sono costruite con una doppia parete permettendo al cibo di mantenere la temperatura più a lungo.

The system elements feature a modular construction, making them extremely versatile. The stackable nature of every element enables space-efficient storage. Bowl boxes can even be stacked with or without bowls. All the system elements are quick and simple to use, with easy to grip edges both underneath the cover panels and underneath the base modules themselves. Cool plates can be used without modular cover panels for a bed of crushed ice. Stainless steel bowl boxes are not only attractive but also insulated, allowing food to maintain its temperature for longer.



IMPILABILE
STACKABLE



UNIVERSALE
UNIVERSAL

PANE - BREAD

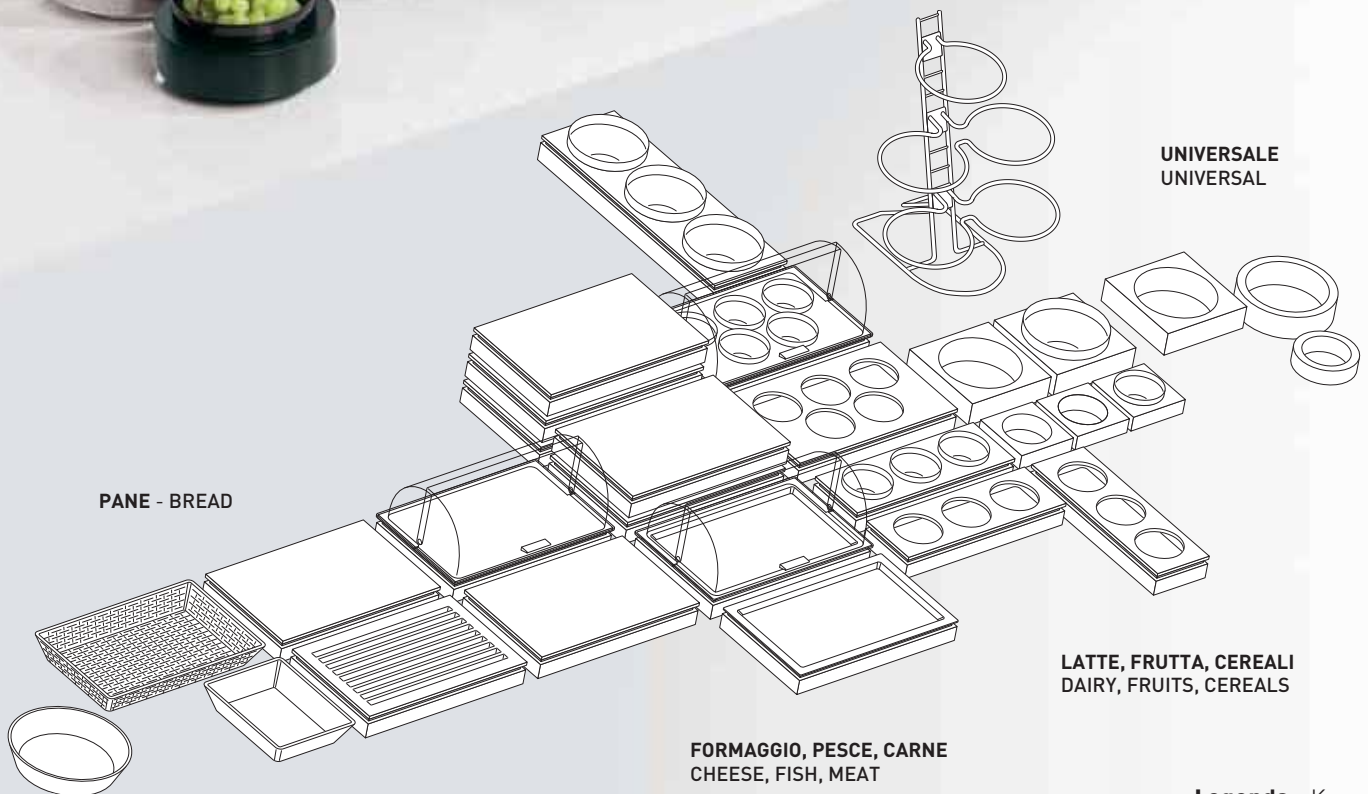

FORMAGGIO, PESCE, CARNE
CHEESE, FISH, MEAT

LATTE, FRUTTA, CEREALI
DAIRY, FRUITS, CEREALS

Legenda - Key:

ACCIAIO INOX STAINLESS STEEL	
WENGE	
ACERO MAPLE	

BAR HAPPY HOUR BUFFET

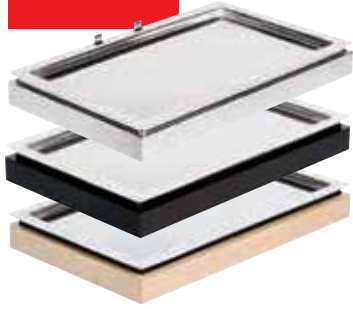

Vetrina refrigerata
Cool plate
Büffet-Vitrine, kühlbar
Vitrine réfrigérée
Vitrina refrigerada

art.	dim. cm.	GN	col.
42450-00	53x32,5x8,5	1/1	●
42460-00	53x32,5x8,5	1/1	●
42470-00	53x32,5x8,5	1/1	●

Base GN 1/1, vassoio inox GN 1/1, eutettico. - GN 1/1 base element, GN 1/1 stainless steel platter, eutectic.



Coperchio GN roll-top, PC
GN roll-top cover
GN-Rolltophaube
Couvercle roll-top, GN
Tapa roll-top, GN

art.	GN
42452-53	1/1

Adatto per cesto/Suitable for bread basket 42461-11.



Modulo per ciotole
Bowl module
Schüssel-Modul
Module pour ravieres
Módulo para fuentes

art.	fori/holes	ø. cm.	GN	col.
42460-03	5	13,2	1/1	●
42470-03	5	13,2	1/1	●



Vassoio, inox
Tray, stainless steel
Serviertablett, Edelstahl Rostfrei
Plateau, inox
Bandeja, acero inox

art.	GN
42451-11	1/1
42451-12	1/2



Tagliere
Cutting board
Tranchierbrett
Planche à découper
Plancha para cortar

art.	dim. cm.	GN	col.
42470-06	acero/maple	1/1	●
42470-07	acero/maple	1/1	●
42460-06	PE	1/1	●



Supporto GN 1/1, legno wengé
Serving stand, wood, wenge
Gestell, Buche massiv, Wenge
Support hêtre massif, wengué
Soporte madera, wengué

art.	dim. cm.	h.
42460-57	57,5x27,5	22



Coperchio ermetico, PC
Airtight cover, PC
Frischhaltedeckel, PC
Couvercle hermétique, PC
Tapa hermética, PC

art.	ø cm.
42452-14	14
42452-23	23



Coperchio, PC
Cover, PC
Deckel, PC
Couvercle, PC
Tapa, PC

art.	ø cm.
42453-23	23



Coperchio, SAN
Cover, SAN
Deckel, SAN
Couvercle, SAN
Tapa, SAN

art.	ø cm.	per/matches
44837C20	20,5	44837-20/B20



Accumulatore di freddo
Eutectic pad
Kühlakku
Cartouche eutectique
Placa eutética

art.	dim. cm.	h.
42450-AD	41x21	2,5



Ciotola tonda, melamina
Round bowl, melamine
Schüssel, rund, Melamin
Bol ronde, melamine
Bol redondo, melamina

art.	ø cm.	h.	lt.
44837B05	14	6,5	0,5
44837B20	20	9,2	1,8
44837B25	23	10,0	2,5



Ciotola tonda, melamina
Round bowl, melamine
Schüssel, rund, Melamin
Bol ronde, melamine
Bol redondo, melamina

art.	ø cm.	h.	lt.
44837-05	14	6,5	0,5
44837-20	20	9,2	1,8
44837-25	23	10,0	2,5



Ciotola tonda, vetro
Round bowl, glass
Glasschüssel, rund
Bol ronde, verre
Bol redondo, vidrio

art.	ø cm.	h.	lt.
41425-AA	7,5	3,5	0,09
41405-AA	14,0	6,5	0,50
41400-AA	23,0	10,0	2,50



Ciotola tonda, inox
Round bowl, stainless steel
Schüssel, rund, Edelstahl R.
Bol ronde, inox
Bol redondo, inox

art.	ø cm.	h.	lt.
42961-14	14	6,5	0,5
42961-23	23	10,0	2,5



Box con ciotola
Box with bowl
Schüssel-Box
Boîte avec bol
Box con bol

art.	dim. cm.	h.	col.
42450-16	17,4x17,4	6	●
42460-16	17,4x17,4	6	●
42470-16	17,4x17,4	6	●

Composto da elemento base e ciotola in melamina bianca ø 14 cm. - Equipped with base element and white melamine bowl ø 14 cm.



Box con ciotola
Box with bowl
Schüssel-Box
Boîte avec bol
Box con bol

art.	ø cm.	h.	col.
42450-18	26,6	8,5	●
42460-18	26,6	8,5	●
42470-18	26,6	8,5	●

Composto da elemento base e ciotola in melamina bianca ø 23 cm. - Equipped with base element and white melamine bowl ø 23 cm.



Box con ciotola
Box with bowl
Schüssel-Box
Boîte avec bol
Box con bol

art.	ø cm.	h.	col.
42450-20	17,4	6	●
42460-20	17,4	6	●
42470-20	17,4	6	●

Composto da elemento base e ciotola in melamina bianca ø 14 cm. - Equipped with base element and white melamine bowl ø 14 cm.



Espositore porta ciotole
Display with bowls
Schüssel-Box
Boîte avec bols
Expositor con bols

art.	dim. cm.	h.	col.
42460-10	79,5x26,5	8,5	●
42470-10	79,5x26,5	8,5	●

Composto da elemento base, vasca polistirene e inserto portaciotole con 3 ciotole in melamina bianca ø 23 cm. Equipped with base element, polystyrene tray, cover panel and 3 white melamine bowls ø 23 cm.



Espositore porta ciotole
Display with bowls
Schüssel-Box
Boîte avec bols
Expositor con bols

art.	dim. cm.	h.	col.
42460-12	53x17,6	8,5	●
42470-12	53x17,6	8,5	●

Composto da elemento base, vasca polistirene e inserto portaciotole con 3 ciotole in melamina bianca ø 14 cm. Equipped with base element, polystyrene tray, cover panel and 3 white melamine bowls ø 14 cm.



Espositore porta ciotole
Display with bowls
Schüssel-Box
Boîte avec bols
Expositor con bols

art.	dim. cm.	h.	col.
42450-14	26,5x26,5	8,5	●
42460-14	26,5x26,5	8,5	●
42470-14	26,5x26,5	8,5	●

Composto da elemento base e ciotola in melamina bianca ø 23 cm. - Equipped with base element and white melamine bowl ø 23 cm.



BAR HAPPY HOUR BUFFET



Cesto pane, PP
Bread basket
Brot-Korb
Corbeille à pain
Cesta pan



art.	ø cm.	h.
42461-35	35	20

Fornito senza coperchio 42452-35.
Roll-top 42452-35 not included.



Coperchio roll-top ,PMMA
Roll-top cover
Rolltophaube
Couvrele roll-top
Campana roll-top

art.	ø cm.
42452-35	38



Cesto pane, PP
Bread basket
Brot-Korb
Corbeille à pain
Cesta pan



art.	dim. cm.	h.	GN
42461-11	53x32,5	6,5	1/1

Fornito senza coperchio 42452-53.
Roll-top 42452-53 not included.



Espositore buffet
Buffet stand
Buffetgestell
Présentoir à céréales
expositor de bufet

art.	dim. cm.	h.	col.
42470-53	53x21	50	●
42460-53	53x21	50	●

Ripiani - Shelves:
30 x 15 cm. - 40 x 17,5 cm. - 53 x 19 cm.



Portaposate, PP
Cutlery dispenser
Besteckbehälter
Bac à couverts
Dispensador de cubiertos

art.	dim. cm.	h.
42584-05	53x32,5	9

Struttura rinforzata in filo cromato.
With reinforced chromed wire structure.



Espositore cereali
Cereal-bar
Cerealien-Buffer-Ständer
Présentoir à céréales
Expositor de cereale

art.	dim. cm.	h.	col.
42470-43	43x17	13,5	●
42460-43	43x17	13,5	●

Set 4 pezzi: supporto in legno con 3 vasi
lt. 2 con coperchio ermetico.
4 pcs. set: wood stand includes 3
glasses lt. 2 with airtight cover.



Distributore di succhi
Juice dispenser
Saftdispenser
Distributeur à jus de fruit
Dispensador de zumo



art.	dim. cm.	h.	lt.	col.
42470-74	31x20	42	4	●
42470-76	35,5x22	50	6	●
42460-74	31x20	42	4	●
42460-76	35,5x22	50	6	●

Con 2 eutettici, coperchio e base
contenitore. - Cooling with 2 cooling
elements from the top and base.



Distributore di cereali
Cereal dispenser
Cerealinspender
Distributeur à céréales
Dispensador de cereales

art.	dim. cm.	h.	lt.	col.
42470-45	21x20	55,5	4,5	●
42460-45	21x20	55,5	4,5	●



Vetrina refrigerata
Cooled buffet showcase
Buffet-Vitrine, kühlbar
Vitrine réfrigérée
Vitrina refrigerada



art.	dim. cm.	h.	col.
42470-63	63,5x42,5	31	●

Vetrina refrigerata
Cooled buffet showcase
Buffet-Vitrine, kühlbar
Vitrine réfrigérée
Vitrina refrigerada



art.	dim. cm.	h.	col.
42460-63	63,5x42,5	31	●

Portaposate
Cutlery dispenser
Besteck-Behälter
Bac à couverts
Caja portacubiertos

art.	dim. cm.	h.	col.
42470-64	57,5x47	12	●
42460-64	57,5x47	12	●

Composta da: base legno con coperchio roll-top fisso, vasca plastica, GN 1/1 in melamina, placca eutettica. - Equipment: wood base with fixed roll-top cover, plastic case, GN 1/1 melamine tray, cooling unit.



Ciotola refrigerata
Cool bowl
Kühlschale
Bol réfrigérée
Bol refrigerada



art.	dim. cm.	h.	lt.	col.
42470-26	18,5x18,5	10	0,5	●
42470-27	27,5x27,5	14	2,5	●

Ciotola refrigerata
Cool bowl
Kühlschale
Bol réfrigérée
Bol refrigerada



art.	dim. cm.	h.	lt.	col.
42460-26	18,5x18,5	10	0,5	●
42460-27	27,5x27,5	14	2,5	●

Composta da: base legno, contenitore inox, ciotola melamina, placca eutettica. Equipment: wood base, stainless steel container, melamine bowl, cooling unit.

N  **BUFFET SYSTEM - SUPERBOX**



LEGNO DI ACACIA / ACACIA WOOD / AKAZIENHOLZ / BOIS D'ACACIA / MADERA DE ACACIA

Superbox è un sistema multifunzionale che si adatta in altezza e larghezza a tutte le esigenze di spazio. Le scatole reversibili, impilabili e antiscivolo possono essere utilizzate singolarmente o collegate con i piani GN. Per creare scenari buffet ad-hoc.

Superbox is a multifunctional buffet system that adapts in height and width to all space requirements. The stackable and non-slip reversible boxes can be used individually or connected with flat GN trays. Different and individual buffet sceneries can be built up.



art. 42463A02 dim. cm. 55,5x35 h. 10,5 GN 1/1

art. 42463A04 dim. cm. 55,5x18,5 h. 10,5 GN 2/4

art. 42463A05 dim. cm. 35x29 h. 10,5 GN 1/2

art. 42463A08 dim. cm. 29x18,5 h. 10,5 GN 1/4



art. 42463B02 dim. cm. 55,5x35 h. 10,5 GN 1/1

art. 42463B04 dim. cm. 55,5x18,5 h. 10,5 GN 2/4

art. 42463B05 dim. cm. 35x29 h. 10,5 GN 1/2

art. 42463B08 dim. cm. 29x18,5 h. 10,5 GN 1/4



Alzata, acacia
Stand, acacia wood
Ständer, Akazienholz
Support, bois d'acacia
Soporte, madera de acacia

N

art.	dim. cm.	h.
42463A00	20x20	17,5

Alzata, acacia
Stand, acacia wood
Ständer, Akazienholz
Support, bois d'acacia
Soporte, madera de acacia

N

art.	dim. cm.	h.
42463B00	20x20	17,5

Alzata, cromata
Serving stand, chrome plated
Serviergestell, Metall hartverchromt
Présentoir, chromé
Soporte platos de postre, cromado

art.	ø cm.	dim.	h.
42962-04	23,5	ø34	37

For 4 plates max. ø 31 cm, inside ø 23,5 cm.



Alzata
Serving stand
Serviergestell
Présentoir
Soporte platos de postre

N

art.	ø cm.	dim.	h.
42962C26	10,5	18,5x15,5	26
42962C44	18,0	29x19,5	43

Finitura rame. - **Copper finishing.**
-26: for 3 plates max. ø 17 cm, inside ø 10,5 cm
-44: for 3 plates max. ø 27 cm, inside ø 18 cm

Alzata, cromata
Serving stand, chrome plated
Serviergestell, Metall hartverchromt
Présentoir, chromé
Soporte platos de postre, cromado

N

art.	ø cm.	dim.	h.
42962-26	10,5	18,5x15,5	26
42962-30	18,0	29x19,5	30
42962-44	18,0	29x19,5	43

-26: for 3 plates max. ø 17 cm, inside ø 10,5 cm
-30: for 2 plates max. ø 27 cm, inside ø 18 cm
-44: for 3 plates max. ø 27 cm, inside ø 18 cm

Copertura igienica in acrilico
Hygienic cover, acrylic
Hygieneschutz, Acryl
Couverture d'hygiène, acrylique
Cobertura d'higiene, acrílico

art.	dim. cm.	h.
42873-65	65x39	42

Supporto cromato.
Chrome plated wire stand.



N

Porta Brezel, faggio
Pretzel stand, beechwood
Brezel- oder Wurstständer, Buche
Support à brezel, hêtre
Soporte para brezel, madera

art.	ø cm.	h.
42870-50	22	50

Protezione igienica, acrilico
Hygienic cover, acrylic
Hygieneschutz, Acryl
Pare-haleine, acrylique
Cubierta higiénica antialiento, acrílico

art.	dim. cm.	h.
42870-51	20x20x20	50



Distributore panini, inox/acrilico
Bread roll-dispenser, s/s-acrylic
Brötchen-Spender, Edelstahl/Acryl
Distributeur à pain, inox/acrylique
Dispensador de pan, inox/acrílico

art.	dim. cm.	h.	pcs
42963-55	32x22	55	65-70



Tagliere pane, legno
Bread cutting board, wood
Brotschneidbrett, Naturholz
Planche à découper en bois
Tabla de corte, madera

art.	dim. cm.	h.
42964-53	53x32,5	2



Taglia pane, base legno
Bread slicer, wood base
Brotschneidergerät, Holzsockel
Coupe-pain, socle bois
Corta-pan, base madera

art.	dim. cm.	h.	kg.
49833-00	41x15	10	2,1



Taglia pane, base legno
Bread slicer, wood base
Brotschneidergerät, Holzsockel
Coupe-pain, socle bois
Corta-pan, base madera

art.	dim. cm.	h.	kg.
49831-00	23x23	21	3,5



CESTI POLYRATTAN
Polyrattan baskets
PAGINA - Page: 177



Coperchio GN
GN cover
GN-Kuppelhaube
Couvercle, GN
Campana GN



art.	dim. cm.	h.	GN
41419-12	33x28	17	1/2



Coperchio GN
GN cover
GN-Kuppelhaube
Couvercle, GN
Campana GN



art.	dim. cm.	h.	GN
41418-11	54x33	20	1/1



Coperchio GN
GN cover
GN-Kuppelhaube
Couvercle, GN
Campana GN



art.	dim. cm.	h.	GN
41418-12	54x33	20	1/1

Con apertura frontale. - One front cut.

Chiuso. - Totally closed.



41439-48

Cloche, PMMA
Dome cover
Abdeckehaube
Cloche
Campana

art.	ø cm.	h.
41416-40	40	20

Pomolo dorato. - Gold plated knob.



41905-03

Coperchio roll-top
Roll-top cover
Rolltophaube
Couvercle roll-top
Campana roll-top



art.	ø cm.	h.
41447-38	38	20

Pomolo cromato. - Chrome knob.



41429-45

Vetrina, 3 pezzi
Showplate, 3-pcs set
Käseglocke, 3-teilig
Etagère, set 3 pièces
Quesera, 3 elementos

art.	ø cm.	h.
41429-04	45	24



Vetrina, set 2 pezzi
Tray, 2-pcs set
Set, 2-Tlg.
Plateau, set 2 pièces
Vitrina, 2 elementos

art.	ø cm.	h.
41447-02	38	21



Set refrigerato, 5 pezzi
Cooled tray, 5-pcs set
Thermo-Set, 5-Tlg.
Plateau réfrigéré, set 5 pièces
Vitrina refrigerada, 5 elementos

art.	ø cm.	h.
41447-05	38	24



Vetrina refrigerata, 3 pezzi
Cooled buffet showcase, 3-pcs set
Büffet-Vitrine, kühlbar, 3-Tlg.
Vitrine réfrigérée, set 3 pièces
Vitrina refrigerada, 3 elementos

art.	ø cm.	h.
41905-38	43	4,5

Fornito senza coperchio 41447-38.
Roll-top 41447-38 not included.



Vetrina refrigerata, 2 piani
Cooled buffet showcase, 2 tiers
Büffet-Vitrine, kühlbar, Doppeldecker
Vitrine réfrigérée, 2 étages
Vitrina refrigerada, doble

art.	ø cm.	h.
41905-03	43,5	50

Fornito senza coperchio 41447-38.
Roll-top 41447-38 not included.



Set refrigerato, 3 pezzi
Cooled tray, 3-pcs set
Thermo-Set, 3-Tlg.
Plateau réfrigéré, set 3 pièces
Vitrina refrigerada, 3 elementos

art.	ø cm.	h.	col.
41944-06	38	6	○
41944B06	38	6	●



Coperchio roll-top
Rolltop cover
Rolltop-Haube
Cloche
Campana

art.	ø cm.	h.
41945-38	38	20

Base non compresa. - Base not included.

SAN



Coperchio GN roll-top, PC
GN roll-top cover
GN-Rolltophaube
Couvercle roll-top, GN
Tapa roll-top, GN

art.	dim. cm.	h.	GN
41415-10	53x32,5	17	1/1
41415-12	32,5x26,5	15	1/2

Barretta dorata. Termoresistente:
-30+120°C. - Gold plated knob. Heat
resistant: -30+120°C.



Coperchio GN roll-top, PC
GN roll-top cover
GN-Rolltophaube
Couvercle GN roll-top
Tapa roll-top GN

art.	dim. cm.	h.	GN
41415-11	53x32,5	17	1/1

Pomolo cromato. Termoresistente:
-30+120°C. Chrome knob. Heat resistant:
-30+120°C.



Vetrina refrigerata, 2 piani
Cooled showcase, 2-tier
Büffet-Vitrine, kühlbar, Doppeldecker
Vitrine réfrigérée, 2 étages
Vitrina refrigerada, 2 niveles

art.	dim. cm.	h.	GN
41428-03	61x38	52	1/1

Fornito senza coperchio 41415-11.
Roll-top 41415-11 not included.

BAR HAPPY HOUR BUFFET



Vetrina refrigerata, inox
Cooled buffet showcase, stainless steel
Büffet-Vitrine, kühlbar, 18/10 Edelstahl
Vitrine réfrigérée, inox
Vitrina refrigerada, 18/10 acero

art.	dim. cm.	h.	GN
41907-56	56,5x36	8,5	1/1



Vetrina refrigerata, faggio
Cooled buffet showcase, beechwood
Büffet-Vitrine, kühlbar, Buche
Vitrine réfrigérée, hêtre
Vitrina refrigerada, madera

art.	dim. cm.	h.	GN
41906-60	59x39	4,5	1/1



Box portaggiaccio, set 3 pz
Ice-box, 3 pcs set
Eisbox, 3-teilig
Boîte à glace, 3 pièces
Cubitera, 3 elementos

art.	dim. cm.	h.	Col.
41412-11	53x32,5	12,5	Wenge

Coperchi NON inclusi. - Lids NOT included. art. 41415-11



IMPILABILE - STACKABLE



PIEDINI ANTISCIVOLO
NON SLIP FEET



Set buffet, rettangolare
Buffet set, rectangular
Buffet-Set, eckig
Présentoir buffet, rectangulaire
Set de buffet, rectangular

art.	dim. cm.	h.	col.
41940-06	43,5x32,5	6	○
41940B06	43,5x32,5	6	●

4 pezzi: contenitore, vassoio, 2 eutettici.
4 pcs.: box, tray, 2 coolers.

Coperchio roll-top
Rolltop cover
Rolltop-Haube
Cloche
Campana

SAN

art.	dim. cm.	h.
41941-44	44X33,5	17

Tagliere legno
Wooden board
Holzschneidebrett
Planche à découper
Tabla de madera

art.	dim. cm.	h.
41941-43	43,5X32,5	2



SAN

Supporto cromato
Serving stand, chrome plated
Serviergestell, hartverchromt
Présentoir, acier chromé
Soporte platos, acero cromado

art.	dim. cm.	h.
44840-06	39x39	17

Supporto cromato
Serving stand, chrome plated
Serviergestell, hartverchromt
Présentoir, acier chromé
Soporte platos, acero cromado

art.	dim. cm.	h.
44840-07	55,5x19	15,5

Set 6 cucchiari
Spoon, 6 pcs set
Feinkostöffel, 6er set
Set 6 cuillères
Juego de 6 cucharas

art.	dim. cm.	col.
44850-00	6x23	trasp./clear
44850W00	6x23	bianco/white
44850B00	6x23	nero/black



SAN

Ciotola, melamina
Bowl, melamine
Schüssel, Melamin
Bol, melamine
Bol, melamina

art.	dim. cm.	h.
44884-12	12,5x12,5	6,0
44884-19	19x19	9,5
44884-25	25x25	12,0

Ciotola, melamina
Bowl, melamine
Schüssel, Melamin
Bol, melamine
Bol, melamina

art.	dim. cm.	h.
44884B12	12,5x12,5	6,0
44884B19	19x19	9,5
44884B25	25x25	12,0

Coperchio
Cover
Abdeckhaube
Couvercle
Campana

art.	dim. cm.	col.
44885-19	19x19	trasp./clear
44885-25	25x25	trasp./clear



Ciotola refrigerata, base inox
Cool bowl, stainless steel base
Kühlschale, Fuß aus 18-10 Edelstahl
Bol réfrigérée, base inox
Bol refrigerda, base acero

art.	ø cm.	h.	lt.
41448-06	14	9,0	0,6
41448-10	14	11,5	1,0

Ciotola refrigerata, base inox
Cool bowl, stainless steel base
Kühlschale, Fuß aus 18-10 Edelstahl
Bol réfrigérée, base inox
Bol refrigerda, base acero

art.	ø cm.	h.	lt.
41448-25	22	14	2,5
41448-40	22	18	4,0

Porta yogurt refrigerato, inox
Cooled yogurt dispenser, stainless steel
Yogurt-Ständer, kühlbar, Edelstahl
Rafraîchissoir à yogurt, inox
Enfriador para yogurt, acero inox

art.	ø cm.
58402-33	33
58402-40	40



Alzata, cromata
Buffet stand, chrome plated
Buffet-Gestell, Metall hartverchromt
Présentoir, chromé
Soporte, cromado

art.	ø cm.	h.
41442-01	24	17

1 ciotola in vetro ø 23 cm, 2,5 lt e 1 coperchio. - 1 glass bowl ø 23 cm, 2,5 lt and 1 hinged cover.

Alzata, 3 piani, cromata
Buffet stand, 3 tiers, chrome plated
Buffet-Gestell, 3-stöckig, Metall hartverchromt
Présentoir, 3 étages, chromé
Soporte 3 pisos, cromado

art.	dim. cm.	h.
41442-03	61x24	35

3 ciotole in vetro ø 23 cm, 2,5 lt e 3 coperchi. - 3 glass bowls ø 23 cm, 2,5 lt and 3 hinged covers.

Espositore cromato
Buffet rack, chrome-plated
Buffet-Ständer, verchromt
Étagère chromée
Dispensador cromado

art.	dim. cm.	h.	ø
41442-14	30x30	14	13,5
41442-23	50x50	18	23

BAR HAPPY HOUR BUFFET



Portaciotole, cromato (senza ciotole)
Bowl holder, chromed (without bols)
Schalenhalter, Metall hartverchromt (ohne Schalen)
Etagère à bols, chromée (sans bols)
Soporte para bols, cromado (sin bols)

art.	ø cm.	h.
41427-40	18	25,5

Per 36 ciotoline ø 7cm. art. 41425-AA
For 36 bowls ø 7cm. item 41425-AA



Portaciotole, cromato (senza ciotole)
Bowl holder, chromed (without bols)
Schalenhalter, Metall hartverchromt (ohne Schalen)
Etagère à bols, chromée (sans bols)
Soporte para bols, cromado (sin bols)

art.	ø cm.	h.
41427-18	17,5	36,5

Per 15 ciotole ø 14 cm. art. 41405-AA
For 15 bowls ø 14cm. item 41405-AA



Multi-distributore, legno
Multi rack, wood
Multi Rack, Holz
Distributeur, bois
Dispensador, madera

art.	dim. cm.	h.
41908-00	26x18	43



Multi-distributore, acrilico
Multi rack, acrylic
Multi Rack, acryl
Distributeur, acrylique
Dispensador, acrílico

art.	dim. cm.	h.
41908-01	26x18	43



Espositore 4 piani, cromato
Buffet ladder 4-tier, chrome plated
Büffet-Leiter 4-stufig, verchromt
Escalier 4 étages, chromé
Escalera 4 alturas, cromada

art.	dim. cm.	h.	ø
41912-04	30x30	48	13,5
41913-04	39x31	66	23,0

Fornito completo di ciotole.
Delivered with bowls.



Espositore 3 piani, cromato
Buffet ladder 3-tier, chrome plated
Büffet-Leiter 3-stufig, verchromt
Escalier 3 étages, chromé
Escalera 3 alturas, cromada

art.	dim. cm.	h.	ø
41912-03	30x30	48	13,5
41913-03	39x31	66	23,0

Fornito completo di ciotole e coperchi.
Delivered with bowls and lids.



Multi-distributore, inox
Multi rack, stainless steel
Multi Rack, 18-10 Edelstahl
Distributeur, inox
Dispensador, acero 18/10

art.	dim. cm.	h.	lt.
41911-04	19x24	53	4x1
41911-03	19x24	41	3x1
41911-02	19x24	28	2x1

Sistema professionale Multi Rack. Varianti ottenibili assemblando canestri e scivoli dalla finitura smerigliata sulle varie strutture in acciaio satinato. Capacità dei canestri 1 litro circa. Lavabili in lavastoviglie. Un pratico organizer per snack bar, caffetterie, self-service, buffet. - Multi Rack professional system. Easy to assemble in different combinations, plastic bowls and slides frosted look on satin finish stainless steel frames. Bowl capacity 1 liter ca. and dishwasher proof. A nice and practical organizer for snack bar, café canteen, buffet.



Supporto cromato
Serving stand, chrome plated
Serviergestell, hartverchromt
Présentoir, acier chromé
Soporte, acero cromado

N

art.	dim. cm.	h.	GN
41403-01	31,5x32	48	3x1/3



Supporto cromato
Serving stand, chrome plated
Serviergestell, hartverchromt
Présentoir, acier chromé
Soporte, acero cromado

N

art.	dim. cm.	h.	GN
41403-02	31,5x41,5	48	3x1/2



Supporto cromato
Serving stand, chrome plated
Serviergestell, hartverchromt
Présentoir, acier chromé
Soporte, acero cromado

N

art.	dim. cm.	h.	GN
41403-03	31,5x56	66	4x1/2



Supporto cromato
Serving stand, chrome plated
Serviergestell, hartverchromt
Présentoir, acier chromé
Soporte, acero cromado

N

art.	dim. cm.	h.	GN
41403-04	52x59	66	3x1/1



BAR HAPPY HOUR BUFFET



Espositore per cereali, plexiglas
Cereal-bar, plexiglas
Cerealien-Bar, Plexiglas
Présentoir à céréales, plexiglas
Expositor de cereales, plexiglas

art.	dim. cm.	h.	lt.
41918-03	38x15,5	4	3x1,5
41918-04	38x15,5	8	3x1,5

Espositore per cereali, plexiglas
Cereal-bar, plexiglas
Cerealien-Bar, Plexiglas
Présentoir à céréales, plexiglas
Expositor de cereales, plexiglas

art.	dim. cm.	h.	lt.
41918-01	26x15,5	4	2x1,5

Espositore per cereali, plexiglas
Cereal-bar, plexiglas
Cerealien-Bar, Plexiglas
Présentoir à céréales, plexiglas
Expositor de cereales, plexiglas

art.	dim. cm.	h.	lt.
41918-02	26x15,5	8	2x1,5



Distributore di cereali, inox
Cereal dispenser, stainless steel
Müslispender, Edelstahl Rostfrei
Distributeur à céréales, inox
Dispensador de cereales, inox

art.	ø cm.	h.	lt.
41909-13	38	54	3x4,5



Distributore di cereali, inox
Cereal dispenser, stainless steel
Müslispender, Edelstahl Rostfrei
Distributeur à céréales, inox
Dispensador de cereales, inox

art.	dim. cm.	h.	lt.
41909-08	35x26,5	68	8



Distributore di cereali
Cereal dispenser
Müslispender
Distributeur à céréales
Dispensador de cereales

art.	dim. cm.	h.	lt.
41810-04	22x17,5	52	4,5



Distributore di cereali DUO
DUO cereal dispenser
Müslispender DUO
Distributeur à céréales DUO
Dispensador de cereales, doble

art.	dim. cm.	h.	lt.
41810-09	22x35	52	4,5x2



Distributore di succhi, inox
Juice dispenser, stainless steel
Saftdispenser, Edelstahl Rostfrei
Distributeur à jus, inox
Dispensador zumos, acero inox

art.	dim. cm.	h.	lt.
58353-17	22x35	56	7



Distributore di succhi, inox
Juice dispenser, stainless steel
Saftdispenser, Edelstahl Rostfrei
Distributeur à jus, inox
Dispensador zumos, acero inox

art.	dim. cm.	h.	lt.
41902-04	21x32	43	4
41902-06	23x35	52	6



Distributore di succhi, inox/faggio
Juice dispenser, s/s-beech wood
Saftdispenser, Edelstahl/Buche
Distributeur à jus, inox/hêtre
Dispensador zumos, inox/madera

art.	dim. cm.	h.	lt.
41907-04	21x31	44	4
41907-06	23x35	52	6



Distributore di latte, inox
Milk dispenser, stainless steel
Milchkanne, Edelstahl Rostfrei
Distributeur à lait, inox
Dispensador de leche, inox

art.	dim. cm.	h.	lt.
41910-03	21x32	39	3
41910-05	23x35	52	5



Distributore di latte, inox/faggio
Milk dispenser, s/s-beech wood
Milchkanne, Edelstahl/Buche
Distributeur à lait, inox/hêtre
Dispensador de leche, inox/madera

art.	dim. cm.	h.	lt.
41920-03	21x32	39	3
41920-05	23x35	52	5



Distributore di succhi DUO, inox
DUO juice dispenser, stainless steel
Saftdispenser DUO, Edelstahl
Distributeur à jus DUO, inox
Dispensador de zumo, doble, inox

art.	dim. cm.	h.	lt.
41917-02	42x35	52	2x6



Distributore di succhi DUO, inox/faggio
DUO juice dispenser, s/s - beech wood
Saftdispenser DUO, Edelstahl/Buche
Distributeur à jus DUO, inox/hêtre
Dispensador de zumo, inox/madera

art.	dim. cm.	h.	lt.
41907-02	42x35	52	2x6



Distributore di succhi, inox
Juice dispenser, stainless steel
Saftdispenser, Edelstahl Rostfrei
Distributeur à jus, inox
Dispensador de zumo, inox

art.	dim. cm.	h.	lt.
41901-08	36x26	55	8



Distributore di succhi DUO, inox
DUO Juice dispenser, stainless steel
Saftdispenser DUO, Edelstahl Rostfrei
Distributeur à jus DUO, inox
Dispensador de zumo, doble, inox

art.	dim. cm.	h.	lt.
41901-16	36x52	55	8x2



Distributore di latte, base legno
Milk dispenser, beech-wood base
Milchkanne, Buchenholz-Fuß
Distributeur à lait, pied en bois
Dispensador de leche, madera

art.	dim. cm.	h.	lt.
41900-04	23x32	42	4
41900-10	27x38,5	45	10



Distributore termico, inox
Insulated dispenser, stainless steel
Iso-Dispenser, Edelstahl Rostfrei
Distributeur isothermique, inox
Dispensador térmico, inox

art.	ø cm.	h.	lt.
41904-10	24	42	9,5



Caraffa vetro
Juice pitcher, glass
Glas-Saftkanne
Carafe à jus de fruits, verre
Jarra zumo, vidrio

art.	ø cm.	h.	lt.
44995-15	9,5	27	1,5

Coperchio inox. - **Stainless steel lid.**
-10°C/+110°C



Caraffa vetro
Juice pitcher, glass
Glas-Saftkanne
Carafe à jus de fruits, verre
Jarra zumo, vidrio

art.	ø cm.	h.	lt.
44995-14	16	27	1,4

Tappo apre e chiude automaticamente.
Piede cromato con eutettico, mantiene
le bevande refrigerate fino a 4 ore.
Spout opens and closes automatically.
**Chromed foot with cooler, keep drinks
chilled up to 4 hours.**



Caraffa vetro
Juice pitcher, glass
Glas-Saftkanne
Carafe à jus de fruits, verre
Jarra zumo, vidrio

art.	ø cm.	h.	lt.
44995-10	9,5	29	1

Tappo versatore apre e chiude
automaticamente. - **Spout opens and
closes automatically while serving.**



Caraffa, PC
Juice pitcher
Saftkanne
Carafe à jus de fruits
Jarra zumo

art.	lt.
44871-30	1,0
44871-31	coperchio / lid



Caraffa con coperchio, PC
Fruit-juice pitcher with cover
Saftkanne mit Deckel
Carafe avec couvercle
Jarra de zumo con tapa

art.	ø cm.	h.	lt.
44993-01	11	30	1,6
44993-02	11	30	1,6



Caraffa con coperchio, PC
Fruit-juice pitcher with cover
Saftkanne mit Deckel
Carafe avec couvercle
Jarra de zumo con tapa

art.	ø cm.	h.	lt.
44993-03	11	30	1,6
44993-04	11	30	1,6



Caraffa, MS
Juice pitcher
Saftkanne
Carafe à jus de fruits
Jarra zumo

art.	ø cm.	h.	lt.
44992-03	26	29	3



Caraffa, MS
Juice pitcher
Saftkanne, Kunststoff
Carafe à jus de fruits
Jarra de zumo

art.	ø cm.	h.	lt.
44994-00	14	29	2,5



Caraffa, MS
Juice pitcher
Saftkanne
Carafe à jus de fruits
Jarra zumo

art.	ø cm.	h.	lt.
44992-02	16,5	26	2

Antiurto e antigraffio, non idoneo al lavaggio in lavastoviglie, resistente fino a +85°C. - **Schokproof, scratchproof, no dishwasher safe, heat resistant up to +85°.**



Caraffa acrilico
Juice pitcher, acrylic
Saftkanne, Acryl
Carafe à jus de fruits, acrylique
Jarra zumo, acrílico

art.	dim. cm.	h.	lt.
44995-25	23x13	27	2,5

Con tubo ghiaccio e camera frutta.
Contenuto con tubo 2,2 lt.
With ice-tube and fruit chamber,
content with tube 2,2 liters.



Caraffa termica, inox
Air pot, stainless steel
Thermopumpkanne, Edelstahl Rostfrei
Pot à air isothermique, inox
Jarra térmica, inox

art.	lt.
42406-35	3,5
42406-40	4,0



Caraffa termica, inox
Air pot, stainless steel
Thermopumpkanne, Edelstahl Rostfrei
Pot à air isothermique, inox
Jarra térmica, inox

art.	lt.
42400-19	1,9
42400-25	2,5
42400-30	3,0

P



Ciotola porta frutta, inox
Fruit bowl, stainless steel
Obstschale, Edelstahl Rostfrei
Bol à fruits, inox
Bol de frutas, inox

art.	ø cm.	h.
41449-27	27,5	32
41449-32	32,0	53

Struttura in filo cromato.
Chrome plated wire.



Alzata frutta, 3 piani, inox
Fruit stand, 3 tiers, stainless steel
Obstständer, 3-stöckig, Edelstahl
Etagère à fruits, 3 étages, inox
Frutero 3 pisos, inox

art.	ø cm.	h.
42940-03	32-38-48	50



Alzata Royale, inox
Fruit stand, stainless steel
Obstständer, Edelstahl Rostfrei
Etagère Royale, inox
Expositor de frutas, inox

art.	ø cm.	h.
41820-03	24-33-42	50



Alzata per torte, alluminio
Wedding cake stand, aluminum
Hochzeitstortenständer, Aluminium
Support pour tourte de mariage, alu
Pedestal para tartas, aluminio

art.	ø cm.
47100-03	20-26-32
47100-04	20-26-32-40
47100-05	20-26-32-40-45
47100-06	20-26-32-40-45-50



Alzata per torte, alluminio
Wedding cake stand, aluminum
Hochzeitstortenständer, Aluminium
Support pour tourte de mariage, alu
Pedestal para tartas, aluminio

art.	ø cm.
47100-07	16-20-26-32-40-45-50
47100-08	16-20-26-32-40-45-50-55
47100-09	16-20-26-32-40-45-50-55-60



Alzata torta, 5 piani, inox
Cake stand, 5 tiers, stainless steel
Kuchenständer, 5-stufig, Edelstahl
Presentoir pâtissier, 5 étages, inox
Pedestal para tartas, 5 niveles, inox

art.	ø cm.	h.
41533-05	11-22-24-30-36	64

Distanziali h. 16,5 cm. - Distance between tiers 16,5 cm.

BAR HAPPY HOUR BUFFET



Coppa punch, polycarbonato
Punch bowl, PC
Punchbowl, PC
Rafraîchisseur, PC
Ponchero, PC

art.	ø cm.	lt.
41541-44	44	15

Piede inox. - Stainless steel bottom ring.



Coppa punch, inox
Punch bowl, stainless steel
Punchbowl, Edelstahl Rostfrei
Rafraîchisseur, inox
Ponchero, acero inox

art.	ø cm.	lt.
11956-37	37	9,5
11956-42	42	15,0

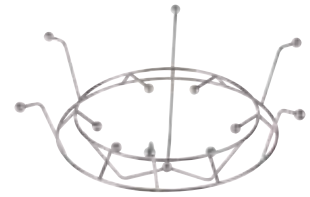

Anello portabottiglie/bicchieri, inox
Bottle/glass ring insert, stainless steel
Flaschen-/Gläser-Einsatzring, Edelstahl
Anneau porte verres et bouteilles, inox
Anillo para botellas y vasos, inox

art.	ø cm.
11956-AA	37



Secchio portabottiglie, acrilico
Big party tub, acrylic
Flaschenkühler-Bowle, acryl
Rafraîchisseur à bouteilles, acrylique
Ponchero, acrílico

art.	dim cm.	h.
44946-04	40x28	23



Secchio portabottiglie, acrilico
Big party tub, acrylic
Flaschenkühler-Bowle, acryl
Rafraîchisseur à bouteilles, acrylique
Ponchero, acrílico

art.	dim cm.	h.	
44946-05	35x35	20	trasp./clear



Secchio portabottiglie, acrilico
Big party tub, acrylic
Flaschenkühler-Bowle, acryl
Rafraîchisseur à bouteilles, acrylique
Ponchero, acrílico

art.	dim cm.	h.	
44946B05	35x35	20	nero/black



Colonna luminosa per piatto frutti di mare
Lightning column for oyster plate
Lichtsäule für Austernplatte
Socle lumineux pour plat à huîtres
Columna luminosa para fuente de mariscos

art.	ø cm.	h.
42979-00	30	21

Composto da un piatto inox ø30 cm. e colonna in PMMA, scatola luci-LED e telecomando. Piatto frutti di mare non incluso. - Stainless steel base plate ø30 cm., PMMA column, LED-light box and remote control. Oyster plate not included.



Piatto frutti di mare, inox
Oyster plate, stainless steel
Austernplatte, Edelstahl Rostfrei
Plat à huîtres, inox
Fuente de mariscos, inox

art.	ø cm.	h.
42979-36	36	4,5
42979-45	45	5,5

Sotto il piatto è fissato un elemento di centraggio che lo mantiene ancorato alla colonna luminosa. - The plate has a centering element which keeps it anchored to the column.



Fontana cocktails, inox
Cocktail fountain, stainless steel
Cocktails-Laufbrunnen, Edelstahl
Fontaine à cocktails, inox
Fuente cocktail, inox

art.	ø cm.	h.	lt.
42981-73	42	56	15

Colonna in PMMA con illuminazione e pompa 10W 220V 50 Hz. Led RGB, telecomando con batteria CR2025, potenza 3W, connettore MR16, tensione 12 V. Possibilità di impostare intensità e velocità di cambiamento colore, possibilità di congelare un colore o illuminazione variabile modalità rendering. Prodotto NON consigliato per liquidi gasati o champagne. - PMMA column with lighting and pump 10W 220V 50 Hz. RGB led, remote control with CR2025 battery, power 3W, connector MR16, 12V voltage, can be set to change color intensity and speed, to stop a color or rendering lighting mode. NOT recommend for use with fizzy drinks or champagne.



Cascata champagne, inox
Champagne Waterfall, stainless steel
Sekt Wasserfall,Edelstahl Rostfrei
Cascade à champagne, inox
Cascada champañã, inox

art.	ø cm.	h.
42980-01	45	5,5

Dotazione: 1 vassoio in acciaio inox, 4 dischi attuglas, 1 colonna in PMMA,illuminazione a led a ciclo multicolore, cassa di trasporto/presentazione.
Equipment: 1 stainless steel tray, 4 attuglas discs, 1 PMMA column, LED lighting multicolor cycle, carrying case/presentation.



Cascata champagne, inox
Champagne Waterfall, stainless steel
Sekt Wasserfall,Edelstahl Rostfrei
Cascade à champagne, inox
Cascada champañã, inox

art.	ø cm.	h.
42980-02	45	5,5

ATLANTIC BUFFET SYSTEM



Pensati e ideati nelle versioni rotonde, rettangolari con aperture differenziate per soddisfare ogni esigenza, gli scaldavivande ABS-Atlantic Buffet System interpretano la funzionalità e la flessibilità contemporanea. Semplici nella forma, impilabili, igienici poiché realizzati in acciaio inox, facilmente smontabili in tutte le loro parti per una pulizia impeccabile, gli elementi appartenenti alla linea nascono dall'expertise che solo Sambonet Paderno è in grado di garantire alla ristorazione d'eccellenza. Grazie alla trasparenza del nuovo oblò in vetro temperato, i coperchi offrono visibilità alla prelibatezza dei contenuti degli scaldavivande. Il meccanismo di chiusura graduale e lo speciale metodo di rimozione dei coperchi rende ancora più performante l'intero Sistema.

Conceived and designed in the round and rectangular versions with different opening systems to meet any need ABS-Atlantic Buffet System chafing dishes combine contemporary flexibility and functionality. All the parts of these simple-shaped, stackable, 100% stainless steel hygienic items can be easily taken apart for thorough cleaning. The line comes from the expertise that only Sambonet Paderno can offer to top catering services. The lid is equipped with a new, transparent window made of unbreakable glass that lets you see the delicacies held in the chafing dishes. The gradual closing mechanism and the special lid removal method make the whole System even more effective.



ABS Round - Acciaio 18-10 - Stainless steel

ART.	Ø CM.	H. CM.	LT.
58176-30	30	15	2,75
58176-36	36	15	5,00
58176-40	40	17	7,80



58166-24	24	15	2,00
58166-30	30	15	2,75
58166-36	36	15	5,00
58166-40	40	17	7,80



Supporto. - Frame.

58166-AA	24	58162-AA	57x47
58166-AM	30		
58166-AB	36		
58166-AC	40		



ABS Rectangular - Acciaio 18-10 - Stainless steel

ART.	DIM. CM.	H. CM.	LT.
58172-54	57x47	18	10



58172-56	68,5x35,5	18	10
----------	-----------	----	----



58162-54	57x47	18	10
----------	-------	----	----



58162-56	68,5x35,5	18	10
----------	-----------	----	----



Dotati di vasca GN 1/1, h 65 mm. - Equipped with pan GN 1/1, h 65 mm.

BAR HAPPY HOUR BUFFET - SERIE ABS

Gli scaldavivande ABS-Atlantic Buffet System sono ideati per ogni tipo di cottura, gas, elettrica, vetroceramica e induzione* per la quale si raccomanda l'utilizzo delle piastre proposte dall'azienda, disponibili sia nella versione da appoggio art. 58162-RA sia da incasso art. 58162-RB. Questi piani ad induzione sono infatti l'ideale per tutti i buffet ove indispensabile mantenere i cibi ad una temperatura ottimale per la conservazione dei sapori.

ABS-Atlantic Buffet System chafing dishes can be used on any heat source, gas, electric, glass-ceramic and induction*. We recommend our free-standing (58162-RA) and built-in (58162-RB) cookers. As a matter of fact, these induction cookers are ideal for any buffet where food should be kept at a specific temperature to preserve flavours.



*NON UTILIZZABILI su piani ad induzione con riconoscimento di frequenza. - NOT SUITABLE for induction hobs with frequency identification.



Piastra ad induzione, da incasso
Induction cooker, to be built into counter
Induktionsplatte, thekeneinbau
Plaque à induction, montage an comptoir
Placa a inducción para emportar

art.	dim. cm.	h.	V	W	kg.
58162-RB	36X38	12,5	220-240	500-3500	5,7

Piano in vetroceramica Schott, timer 0-180 minuti, 1-10 livelli di potenza, temperatura 60-240°C. - Schott ceran hob, timer (0-180 min.), 1-10 power levels, temperature range 60°C-240°C.



Piastra ad induzione
Induction cooker
Induktionsplatte
Plaque à induction
Placa a inducción

art.	dim. cm.	h.	V	W	kg.
58162-RA	30X37	10	220-240	500-2700	6

Corpo inox, piano in vetroceramica Schott, display a led, timer 0-180 minuti, 1-10 livelli di potenza, temperatura 60-240°C. - Stainless steel body, Schott ceran hob, led display, timer (0-180 min.), 1-10 power levels, temperature range 60°C-240°C.

	Descrizione - Description	Art.	dim. cm.	h.	lt.
	Electric heating units - Piastre elettriche - Elektro-Heizelemente Corps de chauffe électriques - Calentadores eléctricos EU per ABS rettangolari - 220V - 380W EU for rectangular ABS	58162-KE	20x25		
	US per ABS rettangolari - 110V - 450W US for rectangular ABS	58162-KU	20x25		
	Electric heating units - Piastre elettriche - Elektro-Heizelemente Corps de chauffe électriques - Calentadores eléctricos EU per ABS tondo ø24 - 220V - 80W EU for ø24 round ABS	58341-KE	ø13,5		
	US per ABS tondo ø24 - 110V - 170W US for ø24 round ABS	58341-KU	ø13,5		
	Electric heating units - Piastre elettriche - Elektro-Heizelemente Corps de chauffe électriques - Calentadores eléctricos EU per ABS tondo ø30 - 220V - 180W EU for ø30 round ABS	58166-KP	20x21		
	Electric heating units - Piastre elettriche - Elektro-Heizelemente Corps de chauffe électriques - Calentadores eléctricos EU per ABS tondo ø36-40 - 220V - 200W EU for ø36-40 round ABS	58166-KE	20x25		
	US per ABS tondo ø36-40 - 110V - 240W US for ø36-40 round ABS	58166-KU	20x25		
	Thermoregulator - Termoregolatore - Thermoregler Thermorégulateur - Termorregulador EU per ABS rettangolari e tondi ø36-40 EU for rectangular and round ø36-40 ABS	58132-AE			
	US per ABS rettangolari e tondi ø36-40 US for rectangular and round ø36-40 ABS	58132-AU			
	Fuel Holder, stainless steel - Portacombustibile, inox Brennstoffhalterung, Edelstahl Rostfrei Porte Brûleur, inox - Contenedor de combustibile, inox Set per ABS ø24-30-36 Kit for ABS ø24-30-36	58136-KA			
	Fuel Holder, stainless steel - Portacombustibile, inox Brennstoffhalterung, Edelstahl Rostfrei Porte Brûleur, inox - Contenedor de combustibile, inox Set per ABS rettangolari e ø40 Kit for ABS rectangular and ø40	58132-KA			
	Round porcelain insert Inserto tondo, porcellana Porzellaneinsatz, rund Bac rond, porcelaine Baño-maria redondo, porcelana	58166-EL 58166-EC N 58166-EB	ø30 ø36 ø40		
	Round porcelain insert, 2 food sections Inserto tondo, porcellana, 2 scomparti Porzellaneinsatz 2-tlg. , rund Bac rond, porcelaine, 2 compartements Baño-maria redondo, porcelana 2 compartimentos	N 58166-ED N 58166-EJ	ø36 ø40		
	Round food pan, stainless steel Portavivande tondo, inox Einsatzbehälter, rund, Edelstahl Rostfrei Bac rond, inox Baño-maria redondo, inox	58166-EG 58166-EM 58166-EH 58166-EI	ø24 ø30 ø36 ø40		

ABS Round - Acciaio 18-10 - Stainless steel

ART.	Ø CM.	H.	LT.	V	W
Riscaldamento a combustibile solido - Solid fuel heating					
58166A24	24	27	2,00		
58166A30	30	27	2,75		
58166A36	36	27	5,00		
58166A40	40	28	7,80		
Riscaldamento elettrico, EU - Electric heating, EU					
58166E24	24	27	2,00	250	80
58166E30	30	27	2,75	250	190
58166E36	36	27	5,00	250	190
58166E40	40	28	7,80	250	190
Riscaldamento elettrico, US - Electric heating, US					
58166U24	24	27	2,00	120	170
58166U36	36	27	5,00	120	240
58166U40	40	28	7,80	120	240



ABS Round - Acciaio 18-10 - Stainless steel

ART.	Ø CM.	H.	LT.	V	W
Riscaldamento a combustibile solido - Solid fuel heating					
58176A30	30	27	2,75		
58176A36	36	27	5,00		
58176A40	40	28	7,80		
Riscaldamento elettrico, EU - Electric heating, EU					
58176E30	30	27	2,75	250	190
58176E36	36	27	5,00	250	190
58176E40	40	28	7,80	250	190
Riscaldamento elettrico, US - Electric heating, US					
58176U36	36	27	5,00	120	240
58176U40	40	28	7,80	120	240



Petite Marmitte - Acciaio 18-10 - Stainless steel

ART.	Ø CM.	H.	LT.	V	W
Riscaldamento a combustibile solido - Solid fuel heating					
58168A24	24	35	7,00		
Riscaldamento elettrico, EU - Electric heating, EU					
58168E24	24	35	7,00	250	80
Riscaldamento elettrico, US - Electric heating, US					
58168U24	24	35	7,00	120	170
Zuppiera senza coperchio - Soup-tureen without cover					
58168-GA	24		7,00		



ABS Rectangular - Acciaio 18-10 - Stainless steel

ART.	DIM. CM.	H.	LT.	V	W
Riscaldamento a combustibile solido - Solid fuel heating					
58162A54	57x47	30,5	10		
Riscaldamento elettrico, EU - Electric heating, EU					
58162E54	57x47	30,5	10	250	360
Riscaldamento elettrico, US - Electric heating, US					
58162U54	57x47	30,5	10	120	450



ABS Rectangular - Acciaio 18-10 - Stainless steel

ART.	DIM. CM.	H.	LT.	V	W
Riscaldamento a combustibile solido - Solid fuel heating					
58172A54	57x47	30,5	10		
Riscaldamento elettrico, EU - Electric heating, EU					
58172E54	57x47	30,5	10	250	360
Riscaldamento elettrico, US - Electric heating, US					
58172U54	57x47	30,5	10	120	450



ART.	DIM. CM.	H.	LT.	V	W
Riscaldamento a combustibile solido - Solid fuel heating					
58162A56	68,5x35,5	30,5	10		
Riscaldamento elettrico, EU - Electric heating, EU					
58162E56	68,5x35,5	30,5	10	250	360
Riscaldamento elettrico, US - Electric heating, US					
58162U56	68,5x35,5	30,5	10	120	450



Dotati di vasca GN 1/1, h 65 mm. - Equipped with pan GN 1/1, h 65 mm.

ART.	DIM. CM.	H.	LT.	V	W
Riscaldamento a combustibile solido - Solid fuel heating					
58172A56	68,5x35,5	30,5	10		
Riscaldamento elettrico, EU - Electric heating, EU					
58172E56	68,5x35,5	30,5	10	250	360
Riscaldamento elettrico, US - Electric heating, US					
58172U56	68,5x35,5	30,5	10	120	450



Dotati di vasca GN 1/1, h 65 mm. - Equipped with pan GN 1/1, h 65 mm.



Asia Rectangular - Acciaio 18-10 - Stainless steel

ART.	DIM. CM.	H.	LT.	KG	V	W
Riscaldamento a combustibile solido - Solid fuel heating						
58132A54	67,5x44	42	10	20		
Riscaldamento elettrico, EU - Electric heating, EU						
58132E54	67,5x44	42	10	20	250	360
Riscaldamento elettrico, US - Electric heating, US						
58132U54	67,5x44	42	10	20	120	450



Riscaldamento a combustibile solido - Solid fuel heating						
58132A55	67,5x44	34,5	10	20		
Riscaldamento elettrico, EU - Electric heating, EU						
58132E55	67,5x44	34,5	10	20	250	360
Riscaldamento elettrico, US - Electric heating, US						
58132U55	67,5x44	34,5	10	20	120	450



Asia Round - Acciaio 18-10 - Stainless steel

ART.	Ø CM.	H.	LT.	KG	V	W
Riscaldamento a combustibile solido - Solid fuel heating						
58136A33	33	44	3,5			
58136A40	40	58	6,0			
Riscaldamento elettrico, EU - Electric heating, EU						
58136E33	33	44	3,5	13	250	200
58136E40	40	58	6,0	25	250	360
Riscaldamento elettrico, US - Electric heating, US						
58136U33	33	44	3,5	13	120	240
58136U40	40	58	6,0	25	120	450



Riscaldamento a combustibile solido - Solid fuel heating						
58136A34	33	34,5	3,5			
58136A41	40	43,0	6,0			
Riscaldamento elettrico, EU - Electric heating, EU						
58136E34	33	34,5	3,5	13	250	200
58136E41	40	43,0	6,0	25	250	360
Riscaldamento elettrico, US - Electric heating, US						
58136U34	33	34,5	3,5	13	120	240
58136U41	40	43,0	6,0	25	120	450



Dotati di vasca GN 1/1, h 65 mm. - Equipped with pan GN 1/1, h 65 mm.

Asia 2000 Rectangular - Acciaio 18-10 - S/S

ART.	DIM. CM.	H.	LT.	V	W
Riscaldamento a combustibile solido - Solid fuel heating					
58152A54	67x49	44	10		
Riscaldamento elettrico, EU - Electric heating, EU					
58152E54	67x49	44	10	250	360
Riscaldamento elettrico, US - Electric heating, US					
58152U54	67x49	44	10	120	450



Dotati di vasca GN 1/1, h. 65 mm. - Equipped with pan GN 1/1, h. 65 mm.

Coffee Urn - Acciaio 18-10 - Stainless steel

ART.	H.	LT.	V	W
Riscaldamento elettrico, EU - Electric heating, EU				
58355E06	50	6	230	500
58355E09	57	9	230	500
58355E12	65	12	230	500
Riscaldamento elettrico, US - Electric heating, US				
58355U06	50	6	115	500
58355U09	57	9	115	500
58355U12	65	12	115	500



Asia 2000 Round - Acciaio 18-10 - Stainless steel

ART.	Ø CM.	H.	LT.	V	W
Riscaldamento a combustibile solido - Solid fuel heating					
58156A33	33	47	3,5		
58156A40	40	61	6,0		
Riscaldamento elettrico, EU - Electric heating, EU					
58156E33	33	47	3,5	250	200
58156E40	40	61	6,0	250	360
Riscaldamento elettrico, US - Electric heating, US					
58156U33	33	47	3,5	120	240
58156U40	40	61	6,0	120	450



Coffee Urn - Acciaio 18-10 - Stainless steel

ART.	H.	LT.	V	W
Riscaldamento a combustibile solido - Solid fuel heating				
58351A06	53	6		
58351A09	59	9		
58351A12	69	12		
58351A18	85	18		



Disponibile anche nella versione elettrica (vedi listino).
Available also with electric heating unit (see price-list).

Acciaio 18-10 - Stainless steel

ART.	DIM. CM.	H.	LT.	V	W
Riscaldamento a combustibile solido - Solid fuel heating					
41693A54	64x35	40	10		
Riscaldamento elettrico, EU - Electric heating, EU					
41693E54	64x35	40	10	250	360
Riscaldamento elettrico, US - Electric heating, US					
41693U54	64x35	40	10	120	450

ART.	DIM. CM.	H.	L.T.
Riscaldamento a combustibile solido Solid fuel heating			
41989A00	67x35	35	9

ART.	DIM. CM.	H.	L.T.
Riscaldamento a combustibile solido Solid fuel heating			
41989A01	67x35	45	9



Dotati di vasca GN 1/1, h 65 mm.
Equipped with pan GN 1/1, h 65 mm.



Dotato di vasca GN 1/1, h 65 mm
e 2 portacombustibili.
Equipped with food pan GN 1/1, h 65 mm
and 2 burner holders.



Dotato di vasca GN 1/1, h 65 mm
e 2 portacombustibili.
Equipped with food pan GN 1/1, h 65 mm
and 2 burner holders.

Acciaio 18-10 - Stainless steel

ART.	DIM. CM.	H.	LT.	V	W
Riscaldamento a combustibile solido - Solid fuel heating					
41694A54	64x35	40	10		
Riscaldamento elettrico, EU - Electric heating, EU					
41694E54	64x35	40	10	250	360
Riscaldamento elettrico, US - Electric heating, US					
41694U54	64x35	40	10	120	450

ART.	DIM. CM.	H.	KG
Riscaldamento a combustibile solido Solid fuel heating			
41694A02	64x35	33	10

ART.	Ø CM.	H.	KG
Scaldavivande per agnello Lamb chafing-dish			
Riscaldamento a combustibile solido Solid fuel heating			
41694A60	66	30	17



Dotati di vasca GN 1/1, h 65 mm.
Equipped with pan GN 1/1, h 65 mm.



Fornito con 2 portacombustibili.
Equipped with 2 fuel-holders.



Fornito con 4 portacombustibili.
Equipped with 4 fuel-holders.



Descrizione - Description	Art.	dim. cm.	h.	lt.
Targhette per scaldacaffè, inox Coffee dispenser plates, stainless steel Kaffeenspender Schilder, Edelstahl Rostfrei Étiquettes pour réchaud à café, inox Etiquetas para calentador de café, inox	58341-EC 58341-EW 58341-EM 58341-ET 58341-NN	11x33 11x33 11x33 11x33 11x33	Coffee Water Milk Tea Clear	
Portavivande tondo, inox Round food pan, stainless steel Einsatzbehälter, rund, Edelstahl Rostfrei Bac rond, inox Baño-maria redondo, inox	58136-EA 58136-EB	ø33 ø40	6,0 7,5	3,5 6,0
Inserto tondo, porcellana Round porcelain insert Porzellaneinsatz, rund Bac rond, porcelaine Baño-maria redondo, porcelana	44352-30 44352-40	ø33 ø40	5,7 7,5	
Inserto tondo, porcellana, 2 scomparti Round porcelain insert, 2 food sections Porzellaneinsatz 2-tlg., rund Bac rond, porcelaine, 2 compartements Baño-maria redondo, porcelana 2 compartimentos	44355-30 44355-40	ø33 ø40	5,7 7,5	
Bacinella GN 1/1, inox Food pan GN 1/1, stainless steel GN-Behälter 1/1, Edelstahl Rostfrei Bac GN 1/1, inox Baño-maria GN 1/1, inox	14102-04 14102-06	53x32,5 53x32,5	4,0 6,5	
Bacinella GN 1/1, porcellana Food pan GN 1/1, porcelain GN-Behälter 1/1, Porzellan Bac GN 1/1, porcelaine Baño-maria GN 1/1, porcelana	44332-03 44332-06	53x32,5 53x32,5	2,0 6,5	
Fuel Holder, stainless steel - Portacombustibile, inox Brennstoffhalterung, Edelstahl Rostfrei - Porte Brûleur, inox Contenedor de combustible, inox Adatto per gli scaldavivande art. 41693 e 41694 Suitable for chafing dishes items 41693 and 41694	41809-09	ø9	6,5	
Fuel Holder, stainless steel - Portacombustibile, inox Brennstoffhalterung, Edelstahl Rostfrei - Porte Brûleur, inox Contenedor de combustible, inox Adatto per gli scaldavivande art. 58152 e 58156 Suitable for chafing dishes items 58152 and 58156	58132-FB	ø10	7,5	
Fuel Holder, stainless steel - Portacombustibile, inox Brennstoffhalterung, Edelstahl Rostfrei - Porte Brûleur, inox Contenedor de combustible, inox Adatto per gli scaldacaffè art. 58351 Suitable for coffee urn item 58351	58132-FA	ø10	5,5	
Electric heating units - Piastre elettriche - Elektro-Heizelemente Corps de chauffe électriques - Calentadores eléctricos EU per rettangolari e tondi ø40 - 220V - 380W EU for rectangular and round ø40	58132-KE	20x25		
US per rettangolari e tondi ø40 - 110V - 450W US for rectangular and round ø40	58132-KU	20x25		
Electric heating units - Piastre elettriche - Elektro-Heizelemente Corps de chauffe électriques - Calentadores eléctricos EU per tondo ø33 - 220V - 200W EU for round ø33	58136-KE	20x20		
US per tondo ø33 - 110V - 240W US for round ø33	58136-KU	20x20		
Electric heating units - Piastre elettriche - Elektro-Heizelemente Corps de chauffe électriques - Calentadores eléctricos EU per scaldacaffè art. 58351 - 220V - 80W EU for coffee urn item 58351	58341-KE	ø13,5		
US per scaldacaffè art. 58351 - 110V - 170W US for coffee urn item 58351	58341-KU	ø13,5		
PYROGEL® Gel combustibile Jelly fuel Brenngel Gel combustible Combustible gel	41695-15 41695-10 41695-50 41695-90	gr.200 lt. 1 lt. 5 lt. 10	u.pack: 2 Kg. 4 Kg. 8	



Caffettiera elettrica
Coffee maker, electric
Kaffeeautomat
Cafetière électrique
Cafetera eléctrica

art.	ø cm.	h.	lt.	V	W
49848-10	25,7	53	10	230	1520
49848-15	25,7	62	15	230	1520
49848-BB	200 filtri/filters				



Caffettiera elettrica
Coffee maker, electric
Kaffeeautomat
Cafetière électrique
Cafetera eléctrica

art.	ø cm.	h.	lt.	V	W
49848-05	18,5	48	5	230	1115
49848-BA	200 filtri/filters				



Scaldacaffè
Coffee urn
Kaffeedispenser
Réchaud à café
Calentador de café

art.	dim. cm.	h.	lt.
41903-10	31x33,5	54,5	10,5



Samovar, inox
Samovar, stainless steel
Samovar, Edelstahl Rostfrei
Samovar, inox
Samovar, acero inox

art.	h.	lt.
58357E06	66	6+1,0*
58357E09	74	9+1,0*
58357E12	82	12+1,6*

230V - 1000W. *Teiera - Tea pot.
Disponibile - Available: 115V - 1000W.



Bollitore d'acqua, inox
Boiler, stainless steel
Kessel, Edelstahl Rostfrei
Chauffe-eau, inox
Caldera acero inox

art.	ø cm.	h.	lt.	Kg
49954-20	47	48	20	5,7
220-240V - 2100W.				



Zuppiera
Soup kettle
Suppenkessel
Marmite à soupe
Olla de sopa

art.	ø cm.	h.	lt.
49790-09	48	32	10
Per induzione. - Suitable for induction.			



N

Zuppiera elettrica, PP
Soup kettle, electric
Suppenwärmer, elektrisch
Marmite à soupe, électrique
Olla de sopa, eléctrica

art.	ø cm.	h.	lt.	V	W
49847-38	38	36,5	10	230	450-550

Inserto in acciaio inox estraibile, mestolo.
Removable stainless steel soup pan,
ladle. Termostato. - Thermostat: +80°C.



N

Zuppiera elettrica, PP
Soup kettle, electric
Suppenwärmer, elektrisch
Marmite à soupe, électrique
Olla de sopa, eléctrica

art.	ø cm.	h.	lt.	KW	kg.
49804-11	34	33	11	0,85	8

Per utilizzo sia con che senza acqua.
Can be used with either wet or dry heat.



Zuppiera elettrica
Soup warmer, electric
Suppenwärmer, elektrisch
Marmite à soupe, électrique
Ollas para sopa, eléctrica

art.	ø cm.	h.	lt.	V	W
49847-08	32	36	9	230	400

Termostato. - Thermostat: +30°C - +90°C.

CARRELLI SALA DINING ROOM TROLLEYS



Struttura portante, piani di servizio in legno multistrato con bordi massicci. Gambe in massello di faggio. Finitura standard tinta palissandro. Su richiesta colori: noce, mogano e rovere. Ruote standard in gomma antistatica, optional ruote in poliuretano. Tutti i carrelli possono essere dotati di profilo paraurti.

Main structure and tops in plywood with reinforced edges. Legs in beechwood. Standard finishing rosewood color. Other colors: walnut, mahogany and oak. Standard swivel casters in antistatic rubber, on request polyurethane casters. All trolleys are available equipped with rubber bumper.

CARRELLI TROLLEY



58874-22 CE

Carrello arrosti/bolliti
Roast beef/stew trolley
Rinderbrust-/Fleischgerichtewagen
Chariot à rôtis
Carro roast beef

art.	dim.cm.	h.	Kg.	Volt	Watt
58874-11	126x62	109	54	120	600
58874-22	126x62	109	54	230	700

Cloche in acciaio inossidabile 18-10 lucido a specchio con apertura a scomparsa a 180° - 4 ruote pivotanti di cui 2 con freno - vasca bagnomaria con 3 portavivande GN 1/2 in acciaio inox da lt 10 cad., h cm 15 - 1 tagliere mobile in wilsonart, mm 354x265 - portapiatti ribaltabile e portacoltelli estraibile in acciaio inox 18-10 - 2 rubinetti di scarico a sfera - 2 piastre elettriche da 700W cad. - 1 spina ad incasso (posteriore carrello) - 3 prese ad incasso (sotto piano carrello) - 2 spine a pipa - cavo di alimentazione - 3 interruttori di cui 1 magnetotermico. Su richiesta è possibile fornire il carrello dotato di piano intermedio.

18-10 stainless steel revolving top adjustable up to 180°, mirror polish finishing - 4 swivel casters, 2 with brakes, bain-marie tank equipped with 3 GN 1/2 stainless steel containers, 10 litres each, height 15 cm - 1 removable wilsonart cutting board mm 354x265 revolving plate rack and removable knife holder in 18-10 stainless steel - 2 taps for water discharge - 2 heating units 700W each - 1 built in plug, backside - 3 built-in plugs, deck downside - 2 pipe plugs - cable - 3 switches, (1 magneto-termic). Upon request, the trolley can be supplied equipped with intermediate shelf.



CE

Carrello flambé
Flambé trolley
Flambierwagen
Chariot à flamber
Carro flambé

art.	dim. cm.	h.	Kg.
58876-00	122x58,5	89,5	44,5

4 ruote pivotanti di cui 2 con freno - pianale inox mm 540x1042 completo di barriera portabottiglie - 2 piani d'appoggio inferiori in legno - vano porta bombole con sportello di chiusura - gruppo gas/bruciatore/accenditore - dispositivo di accensione piezoelettrico - funzionamento a gas liquido butano in bombola ricaricabile da kg 2,75 (autonomia 20 ore circa) oppure da kg 1,8 - bombola NON fornita. - 4 swivel casters, 2 with brakes - upper deck in 18-10 stainless steel mm 540x1042 with bottle holder protection ring - 2 lower wooden decks - cabinet for gas cylinder - gas/burning/lighting unit - piezoelectric lighting device - operating with liquid butan gas, 2,75 kg rechargeable cylinder (lasting for 20 hours about) or 1,8 kg cylinder - trolley supplied without cylinder.



CE

Carrello flambé, elettrico
Flambé trolley, electric
Flambierwagen, elektrisch
Chariot à flamber, électrique
Carro flambé, eléctrico

art.	dim. cm.	h.	Kg.
58876-01	122x58,5	89,5	44,5

4 ruote pivotanti di cui 2 con freno - pianale inox mm 540x1042 completo di barriera perimetrale - 2 piani d'appoggio inferiori in legno - piastra elettrica high-light da incasso ø 32 cm, piano riscaldante in vetroceramica ø 26 cm, alimentazione 230V-2300W - 1 spina ad incasso (posteriore carrello) - cavo di alimentazione - regolatore di energia ed interruttore magnetotermico. - 4 swivel casters, 2 with brakes - upper deck in 18-10 stainless steel mm 540x1042 with protection ring - 2 lower wooden decks - built-in electric heating unit, high-light, ø 32 cm, ceramic heating surface ø 26 cm, power 230V-2300W - 1 built-in plug, backside - cable - adjustable heat control unit and 1 magneto termic switch.



CE

Carrello flambé, 2 fuochi
Flambé trolley, 2 burners
Flambierwagen, 2 Brenner
Chariot à flamber, 2 feux
Carro flambé, 2 fuegos

art.	dim. cm.	h.	Kg.
58877-00	122x58,5	89,5	46,5

4 ruote pivotanti di cui 2 con freno - pianale inox mm 540x1042 completo di barriera perimetrale - 2 piani d'appoggio inferiori in legno - vano porta bombole con sportello di chiusura - 2 gruppi gas/bruciatore/accenditore - dispositivo di accensione piezoelettrico - funzionamento a gas liquido butano in bombola ricaricabile da kg 2,75 (autonomia 20 ore circa) oppure da kg 1,8 - bombola NON fornita. - 4 swivel casters, 2 with brakes - upper deck in 18-10 stainless steel mm 540x1042 with protection ring - 2 lower wooden decks - cabinet for gas cylinder - 2 gas/burning/lighting units - piezoelectric lighting device - operating with liquid butan gas, 2,75 kg rechargeable cylinder (lasting for 20 hours about) or 1,8 kg cylinder - trolley supplied without cylinder.



CE

Carrello mini-flambé
Mini flambé trolley
Flambierwagen, Mini-Ausführung
Chariot à flamber, mini
Mini carro flambé

art.	dim. cm.	h.	Kg.
58875-00	77,5x51	74,5	22

4 ruote pivotanti, senza freno - piano superiore in acciaio inox 18-10, satinato - vano inferiore con portabottiglie.
4 swivel casters without brakes - upper deck in 18-10 stainless steel, satin finishing - lower deck with bottle holder.



Carrello antipasti
Hors d'oeuvre trolley
Vorspeisewagen
Chariot à hors d'oeuvres
Carro entremeses

art.	dim. cm.	h.	Kg.
58878-00	122x62	106	38

4 ruote pivotanti di cui 2 con freno - cupola in metacrilato, con apertura a scomparsa - piano porta-vaschette antipasti in acciaio inox 18-10 con barriera perimetrale - 9 vaschette antipasti in vetro, dim. mm 123 x 203. Su richiesta è possibile fornire il carrello dotato di piano intermedio.
4 swivel casters, 2 with brakes - metacrilat revolving cloche - hors d'oeuvre inserts carrying deck in 18-10 stainless steel with protection ring - 9 hors d'oeuvre glass inserts, mm 123x203. Upon request, the trolley can be supplied equipped with intermediate shelf.



Carrello antipasti, refrigerato
Cooled hors d'oeuvre trolley
Vorspeisewagen, gekühlt
Chariot à hors d'oeuvres, réfrigéré
Carro entremeses, refrigerado

art.	dim. cm.	h.	Kg.
58879-00	122x62	106	38

4 ruote pivotanti di cui 2 con freno - cupola in metacrilato, con apertura a scomparsa - copertura vasca per contenitori eutectici in acciaio inox 18-10 - 8 contenitori eutectici da kg 1 cadauno, dim. mm 170 x 200 - 9 vaschette antipasti in vetro, dim. mm 123 x 203. Su richiesta è possibile fornire il carrello dotato di piano intermedio.

4 swivel casters, 2 with brakes - metacrilat revolving cloche - eutectic pads container with 18-10 stainless steel cover - 8 eutectic pads 2,2 lbs each, mm 170x200 - 9 hors d'oeuvre glass inserts, mm 123x203. Upon request, the trolley can be supplied equipped with intermediate shelf.



Carrello pasticceria Omicron
Pâtisserie trolley
Kuchen-/Nachspeisewagen
Chariot à pâtisserie
Carro postres

art.	dim. cm.	h.	Kg.
58880-00	113x56,5	104	57

Cupola tonda in metacrilato, montata su guide laterali, che ne permettono la rotazione nei due sensi - 4 ruote pivotanti di cui 2 con freno - 1 piano fisso in metacrilato mm 200x750 - 1 piano mobile in metacrilato mm 400x750 - 2 portapiatti ribaltabili in acciaio inox 18-10 - 2 piani d'appoggio inferiori in legno. - Metacrilat revolving cloche, bifrontal rotation - 4 swivel casters, 2 with brakes - 1 upper fixed deck in metacrilat mm 200x750 - 1 upper removable deck in metacrilat mm 400x750 - 2 revolving plate racks in 18-10 stainless steel - 2 lower wooden decks.



Carrello dolci-formaggi
Cake and cheese trolley
Dessert-/Käsewagen
Chariot à fromages et desserts
Carro postres/quesos

art.	dim. cm.	h.	Kg.
58882-00	122x62	106	38

4 ruote pivotanti di cui 2 con freno - cupola in metacrilato, con apertura a scomparsa - tagliere in texwood faggio naturale mm 728 x 424 - portapiatti ribaltabile in acciaio inox 18-10. Su richiesta è possibile fornire il carrello dotato di piano intermedio. - 4 swivel casters, 2 with brakes - metacrilat revolving cloche - beech texwood cutting board mm 728x424 - revolving plate rack in 18-10 stainless steel. Upon request, the trolley can be supplied equipped with intermediate shelf.



Carrello dolci, refrigerato
Cooled cake trolley
Dessertwagen, gekühlt
Chariot à desserts, réfrigéré
Carro postres, refrigerado

art.	dim. cm.	h.	Kg.
58884-00	122x62	106	47,5

4 ruote pivotanti di cui 2 con freno - cupola in metacrilato, con apertura a scomparsa - vaschetta porta contenitori eutettici con copertura in acciaio inox 18-10 - 8 contenitori eutettici da kg 1 cadauno, mm 170x200 - portapiatti ribaltabile in acciaio inox 18-10. Su richiesta è possibile fornire il carrello dotato di piano intermedio.

4 swivel casters, 2 with brakes - metacrilat revolving cloche - eutectic pads container with 18-10 stainless steel cover - 8 eutectic pads 2,2 lbs each, mm 170x200 - revolving plate rack in 18-10 stainless steel. Upon request, the trolley can be supplied equipped with intermediate shelf.



Carrello mini-formaggi, refrigerato
Cooled mini cheese trolley
Käsewagen, gekühlt, Mini-Ausführung
Chariot à fromages, réfrigéré, mini
Mini carro quesos, refrigerado

art.	dim. cm.	h.	Kg.
58895-00	77,5x51	94	16,5

4 ruote pivotanti senza freno - cupola in metacrilato, con apertura a 90° - vaschetta porta contenitori eutettici (eutettici inclusi) con copertura in acciaio inox - 1 tagliere mobile, GN 1/1 - portapiatti ribaltabile in acciaio inox. - 4 swivel casters without brakes - metacrilat roll-top cover, opening at 90° - eutectic pads container with stainless steel cover (eutectic pads incl.) - 1 removable cutting board, GN 1/1 - revolving plate rack in stainless steel.



Carrello gueridon, standard
Standard gueridon trolley
Gueridonwagen, Standard
Chariot gueridon, standard
Carro gueridon estándar

art.	dim. cm.	h.	Kg.
58886-00	77,5x51	74,5	14,5

4 ruote pivotanti, senza freno. Su richiesta è possibile fornire il carrello dotato di piano intermedio.

4 swivel casters without brakes. Upon request, the trolley can be supplied equipped with intermediate shelf.



Carrello gueridon, de luxe
 De luxe gueridon trolley
 Gueridonwagen, Luxus-Ausführung
 Chariot gueridon, de luxe
 Carro gueridon, de luxe

art.	dim. cm.	h.	Kg.
58887-00	77,5x51	74,5	16,5

4 ruote pivotanti, senza freno - cassettera a sei scomparti - piano d'appoggio estraibile.

4 swivel casters without brakes - 6 compartments drawer - removable upper deck.



Carrello vini
 Wine trolley
 Weinwagen
 Chariot à vins
 Carro de vinos

art.	dim. cm.	h.	Kg.
58897-00	122x62	92	39

4 ruote pivotanti di cui 2 con freno - barriera porta bottiglie in acciaio inox - contenitore per tappi e carta vini - vano con 6 glacette (glacette incluse) - rastrelliera porta bicchieri, sotto piano carrello - piano inferiore con rastrelliera porta bottiglie, 12 posti. - 4 swivel casters, 2 with brakes - upper deck with stainless steel bottle holder ring - bottle caps and wine card compartment - 6 compartments for bottle coolers (bottle coolers included) - glass rack, deck downside - lower deck with bottle rack, 12 compartments.



Carrello liquori
 Liqueur trolley
 Aperitif-/Digestivwagen
 Chariot à liqueurs
 Carro licores

art.	dim. cm.	h.	Kg.
58889-00	124x68,5	104	37

4 ruote pivotanti di cui 2 con freno - barriera portabottiglie in acciaio inox 18-10.

4 swivel casters, 2 with brakes - bottle holder protection ring in 18-10 stainless steel.



Carrello servizio
 Serving trolley
 Servierwagen
 Chariot à servir
 Carro de servicio

art.	dim. cm.	h.	Kg.
58891-00	122x58,5	89,5	35,5

4 ruote pivotanti di cui 2 con freno - piano estraibile e cassetto in legno. Su richiesta è possibile fornire il carrello dotato di piano intermedio.

4 swivel casters, 2 with brakes - removable upper deck and wooden drawer. Upon request, the trolley can be supplied equipped with intermediate shelf.



Carrello sorbetti
Sherbet/ice cream trolley
Sorbetwagen
Chariot à sorbets/glacés
Carro sorbetes

art.	dim. cm.	h.	Kg.
58893-00	122x62	93	43

4 ruote pivotanti di cui 2 con freno - 4 sorbettiere termiche in acciaio inox 18-10 da lt 1,2 cadauna - cassetto porta-posate - portapiatti ribaltabile e portapalette-gelato in acciaio inox 18-10.

4 swivel casters, 2 with brakes - 4 18-10 stainless steel insulated sherbet holders (lt 1,2 each) - flatware drawer - revolving plate rack and ice cream scoops holder in stainless steel.



Carrello tondo
Round trolley
Servierwagen, rund
Chariot rond
Carro redondo

art.	ø cm.	h.	Kg.
58888-00	60	89,5	23

4 ruote pivotanti, senza freno - piano d'appoggio laterale estraibile - barriera perimetrale. - 4 swivel casters without brakes - removable upper deck - perimeter barrier.



PORTAPIATTI RIBALTABILE LATO CORTO
REVOLVING DISH HOLDER SHORT SIDE

OPTIONAL



Griglia inox per l'esposizione di pesce (1) o dolci/formaggi (2) da specificare all'ordine.
Stainless steel grid for fish (1) or cakes/cheese (2) to be specified at the order.

OPTIONAL: 3X GN 1/1 h. 150mm.

Carrello refrigerato
Refrigerated trolley
Kühlwagen
Chariot réfrigéré
Carro refrigerado

art.	dim. cm.	h.	V	W
49994-03	121x69	118	230	328

Carrello refrigerato con struttura in legno laminato. Cupola semisferica a doppia apertura. Vasca profonda 18 cm. con rubinetto di scarico. Refrigerazione statica gas R404a. Termostato digitale (+2°/+8°C). Maniglia di spinta e due ruote con freno, portapiatti lato lungo ribaltabile.

Refrigerated trolley, laminated wood structure. Hemispherical double opening side dome. Well 18 cm. deep, equipped with drain cock. Static refrigeration of the well, gas R404a. Digital thermostat (+2°/+8°C). Pushing handle and 2 castors with brake, revolving dish shelf long side.

Realizzabile in 17 colori. - Can be manufactured in 17 different colors.

SERIE VERSAILLES
CARRELLI SALA DINING ROOM TROLLEYS



Carrello dolci
 Dessert trolley
 Dessert-Wagen
 Chariot à desserts
 Carro postres

art.	dim. cm.	h.
49994-04	47x89	103

Fornito smontato. Struttura in tubo tondo cromato con piani in legno laminato. 4 ruote pivotanti di cui 2 con freno. - **To be assembled. Tubular chromed structure with wooden shelves. 4 swivel casters, 2 with brakes.**



Carrello di servizio, PP
 Serving trolley, PP
 Mehrzweckwagen, PP
 Chariot de service, PP
 Carrito para desocupar, PP



art.	dim. cm.	h.
49995-04	97x51	99

Maniglie ergonomiche arrotondate, pannelli laterali e bordo paraurti arrotondato. Portata 135 kg (45 kg per ripiano). Ruote girevoli, antiruggine e silenziose. Colore nero. - **Swivel casters for easy manoeuvrability. Ergonomic handles, high load capacity (45 kg per shelf). Ultra-quiet mark-resistant casters. Black color.**



OPTIONAL : spondine di contenimento, cassetta portaposate 3 scomparti, pianetto portapiatto estraibile, 17 varianti colore.
 OPTIONAL: protection frame, 3 compartments cutlery box, extractable dish holder, 17 colors available.



Carrello gueridon a 2 piani
 Gueridon trolley with 2 shelves
 Gueridon-Wagen mit 2 Etagen
 Chariot gueridon à 2 niveaux
 Carro gueridon con 2 estantes

art.	dim. cm.	h.
49995-01	47x89	92



Carrello gueridon a 3 piani
 Gueridon trolley with 3 shelves
 Gueridon-Wagen mit 3 Etagen
 Chariot gueridon à 3 niveaux
 Carro gueridon con 3 estantes

art.	dim. cm.	h.
49995-02	47x89	92

Fornito smontato. Carrello in laminato (17 varianti colore) con struttura cromata, 4 ruote pivotanti di cui 2 con freno.
To be assembled. Chromed structure with laminated shelves (17 colors available), 4 swivel casters, 2 with brakes.



Carrello dolci/liquori
Dessert/liqueur trolley
Dessert-/Likörwagen
Chariot à desserts/liqueurs
Carro postres/licores

art. dim. cm. h.
49995-03 103x54 103

Fornito smontato. Struttura in tubo tondo cromato e ripiani in laminato. 4 ruote pivotanti di cui 2 con freno. Disponibile in 17 colori. - To be assembled. Tubular chromed structure with laminated shelves. 4 swivel casters, 2 with brakes. Available in 17 colors.



Carrello con vetrina refrigerata
Trolley with cooled showcase
Servierwagen mit Kühlvitrine
Chariot gueridon, vitrine réfrigérée
Carro servizio, vetrina refrigerada

art. dim. cm. h.
49995-06 103x54 103,8

Per antipasti, dolci e formaggi. Cupola emisferica a doppia apertura. Espositore refrigerato tramite 3 piastre eutettiche (fino a 5 ore). 2 ruote con freno. Disponibile in 17 colori. - For hors d'oeuvres, cheese and desserts. Double opening hemispherical dome. Refrigerated by 3 eutectic plates (keeps low temperatures up to 5 hours). 2 casters with brake. Available in 17 colors.



N

Realizzabili in 17 colori di legno laminato e completati con vari optional per qualsiasi necessità di utilizzo. Buffet disponibili anche in dimensione 4 e 5 GN 1/1.

Can be manufactured in 17 different laminated wood colors and can be equipped with various optional to satisfy any needs. Buffet available also in 4 and 5 GN 1/1 sizes.



Buffet refrigerato, 3x GN 1/1
Refrigerated buffet
Kühl-Bufferwagen
Buffet réfrigéré
Buffet refrigerado

N

art. dim. cm. h.
49994-06 74,3x117 151

Refrigerati con struttura in legno laminato. Calottina superiore in Plexiglass fissa. Vasca profonda 26 cm. con rubinetto di scarico. Refrigerazione statica gas R404a. Termostato digitale (+2°/+8°C). Illuminazione a LED. Due ruote in poliammide con freno di serie. Refrigerated buffets with laminated wood structure. Upper Plexiglas fixed sneeze-guard. Well 26 cm. deep with drain cock. Static refrigeration of the well, gas R404a. Digital thermostat (+2°/+8°C) and lighting with LED. Two polyamide castors with brake included.

Completo di portapiatti perimetrale, chiusura vano inferiore con pareti e porte con sistema di chiusura rallentata. OPTIONAL da ordinarsi separatamente: griglie inox 3x GN 1/1, vasche GastroNorm.

Supplied with perimeter dish shelf, lower compartment closure with walls and doors with slow closing system.

OPTIONALS to be ordered separately: stainless steel grid 3x GN 1/1, GastroNorm pans.



Buffet bagnomaria con alogene, 3x GN 1/1
Heated buffet with halogen lamps
Beheizte Buffetwagen mit Halogenlampen
Buffet chauffé avec lampes halogènes
Buffet caliente con lámparas halógenas

N

art. dim. cm. h.
49994-10 74,3x117 151

Riscaldato con struttura in legno laminato. Calottina superiore in Plexiglass fissa. Vasca profonda 26 cm. con rubinetto di scarico. Riscaldamento a bagnomaria con termostato digitale. Due ruote in poliammide con freno di serie. Lampade alogene ad accensione indipendente.

Heated buffet, laminated wood structure. Upper fixed sneeze-guard. Well depth 26 cm. with drain cock. Bain marie heating and digital thermostat. Two castors with brake included. Equipped with halogen lamps over the well with independent switch.

Completo di portapiatti perimetrale, chiusura vano inferiore con pareti e porte con sistema di chiusura rallentata. OPTIONAL da ordinarsi separatamente: griglie inox 3x GN 1/1, vasche GastroNorm.

Supplied with perimeter dish shelf, lower compartment closure with walls and doors with slow closing system.

OPTIONALS to be ordered separately: stainless steel grid 3x GN 1/1, GastroNorm pans.

PASTRY UTENSILS

PASTICCERIA
PASTRY UTENSILS
KONDITOREI-ARTIKEL
LA PÂTISSERIE
PASTELERÍA

PREPARAZIONE *PREPARATION TOOLS*



PASTICCERIA PASTRY UTENSILS
TAGLIAPASTA INOX - STAINLESS STEEL CUTTERS



Alfabeto
 Alphabet

art.	ø cm.	h.	pz/pcs
47301-12	12	2	26



Numeri
 Numbers

art.	ø cm.	h.	pz/pcs
47302-10	10	2	10



Animali
 Animals

art.	ø cm.	h.	pz/pcs
47303-10	10	2	10



Sagome
 Shapes

art.	ø cm.	h.	pz/pcs
47304-06	6,5	2	12



Sagome
 Shapes

art.	ø cm.	h.	pz/pcs
47304-10	10,0	2	12



Sagome
 Shapes

art.	ø cm.	h.	pz/pcs
47304-12	12,0	2	12



Sagome
 Shapes

art.	ø cm.	h.	pz/pcs
47305-12	12	2	12



Fiore
 Flower

art.	ø cm.	h.	pz/pcs
47306-10	10	3	6



Trio
 Trio

art.	ø cm.	h.	pz/pcs
47307-10	10	3	6



Cuore
 Heart

art.	ø cm.	h.	pz/pcs
47308-10	10	3	6



Stella
 Star

art.	ø cm.	h.	pz/pcs
47310-10	10	3	6



Mezzaluna
 Halfmoon

art.	ø cm.	h.	pz/pcs
47312-10	10	3	6

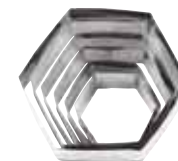

Esagono
 Hexagon

art.	ø cm.	h.	pz/pcs
47314-10	10	3	6



Esagono festonato
 Hexagon, fluted

art.	ø cm.	h.	pz/pcs
47315-10	10	3,5	5



Anello
 Ring

art.	ø cm.	h.	pz/pcs
47316-10	10	3,0	11
47316-12	12	3,0	14
47316-20	20	2,5	20



Anello festonato
 Ring, fluted

art.	ø cm.	h.	pz/pcs
47317-10	10	3,0	11
47317-12	12	3,0	14
47317-20	20	2,5	20



PASTICCERIA PASTRY UTENSILS



Goccia
Drop
art. 47321-12 ø cm. 12 h. 3 pz/pcs 6



Goccia festonata
Drop, fluted
art. 47322-12 ø cm. 12,5 h. 3,5 pz/pcs 5



Quadro
Square
art. 47323-12 ø cm. 12 h. 3 pz/pcs 6



Quadro festonato
Square, fluted
art. 47324-12 ø cm. 12,5 h. 3,5 pz/pcs 6



Ovale festonato
Oval fluted
art. 47325-10 ø cm. 10 h. 3,5 pz/pcs 9



Ovale
Oval
art. 47326-10 ø cm. 10 h. 3,5 pz/pcs 9



Frutta
Fruit
art. 47327-12 ø cm. 12,5 h. 2 pz/pcs 12



Animali
Animals
art. 47328-15 ø cm. 15 h. 2 pz/pcs 10



Veicoli
Vehicles
art. 47331-15 ø cm. 15 h. 2 pz/pcs 7



Verdura
Vegetable
art. 47332-12 ø cm. 12,5 h. 2 pz/pcs 12



Natale
Christmas
art. 47333-15 ø cm. 15 h. 2 pz/pcs 7



Pasqua
Easter
art. 47334-12 ø cm. 12,5 h. 2 pz/pcs 6



Stelle
Stars
art. 47335-12 ø cm. 12,5 h. 2 pz/pcs 7



Sagome
Shapes
art. 47419-10 cm. 20 h. 3,5 pz/pcs 10



Tagliapasta geometrici, 42 pz
Set 42 geometric shape cutters
art. 47336-42 ø 6→22



Cerchio liscio, set 3 pz
Round cutter, 3 pcs set
art. 47414-03 h. cm. 3 ø 6-7-8



Cerchio festonato, set 3 pz
Round cutter, fluted 3 pcs set
art. 47415-03 h. cm. 3 ø 6-7-8



Canestrello
Canestrello cutter
art. 47416-06 cm. 6 h. 3



Canestrello
Canestrello cutter
art. 47417-06 cm. 6 h. 3



Ruota tagliapaste
Cutter wheel
art. 47418-00

TAGLIAPASTA INOX P STAINLESS STEEL CUTTERS



NATALE - CHRISTMAS



Omino pan di zenzero
Gingerbread man

art.	dim. cm.	h.
47370-08	6x8	3



Angelo
Angel

art.	dim. cm.	h.
47377-08	7x7	3



Pupazzo di neve
Snowman

art.	dim. cm.	h.
47378-08	4x8	3



Renna
Reindeer

art.	dim. cm.	h.
47379-08	8x7	3

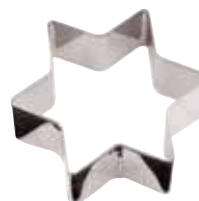

Stella
Star

art.	dim. cm.	h.
47411-08	8x8	3



Stella cometa
Comet

art.	dim. cm.	h.
47412-08	8x4	3



Albero di Natale
Christmas tree

art.	dim. cm.	h.
47413-08	8x8	3



Pino
Pine

art.	dim. cm.	h.
47413-01	6,4x8,1	3



Fiocco di neve
Snowflake

art.	dim. cm.	h.
47411-01	7,4x8,6	3



Fiocco di neve
Snowflake

art.	dim. cm.	h.
47411-02	6,9x7,9	3



Fiocco di neve
Snowflake

art.	dim. cm.	h.
47411-03	8,4x7,7	3

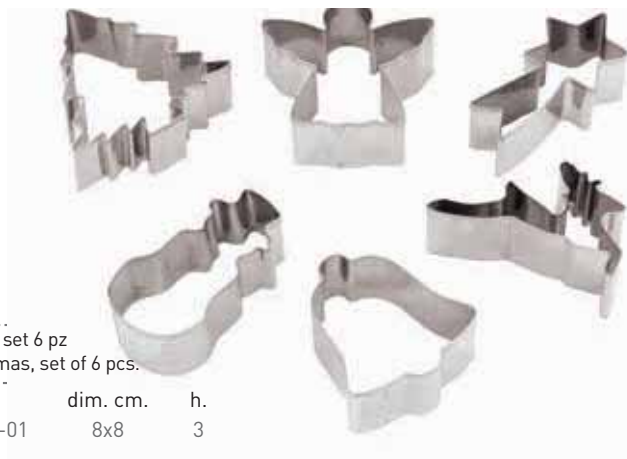

Natale set 6 pz
Christmas, set of 6 pcs.

art.	dim. cm.	h.
47387-01	8x8	3

PASQUA - EASTER



Coniglio
Rabbit

art.	dim. cm.	h.
47372-08	8x4	3



Coniglio
Rabbit

art.	dim. cm.	h.
47402-08	8x5	3



Coniglio
Rabbit

art.	dim. cm.	h.
47402-01	7,1x8,6	3



Coniglio
Rabbit

art.	dim. cm.	h.
47402-02	7,6x7,3	3



Campana
Bell

art.	dim. cm.	h.
47373-08	6x7	3



Agnellino
Lamb

art.	dim. cm.	h.
47376-08	8x7	3



Colomba
Dove

art.	dim. cm.	h.
47382-08	8x7	3



Uovo
Egg

art.	dim. cm.	h.
47373-01	5,6x8,2	3



Pasqua set 5 pz
Easter, set of 5 pcs.

art.	dim. cm.	h.
47387-02	8x8	3

HALLOWEEN



Scheletro
Skeleton

art.	dim. cm.	h.
47370-08	6x8	3



Zucca
Pumpkin

art.	dim. cm.	h.
47377-09	8,7x7,8	3



Zucca
Pumpkin

art.	dim. cm.	h.
47377-10	7,9x7,9	3



Mezzaluna
Crescent

art.	dim. cm.	h.
47377-01	6,2x8	3



Gufo
Owl

art.	dim. cm.	h.
47377-02	4,7x8,3	3



Fantasma
Ghost

art.	dim. cm.	h.
47377-03	7,8x8,4	3



Strega
Witch

art.	dim. cm.	h.
47377-04	9,3x9,6	3



Cappello trega
Witch hat

art.	dim. cm.	h.
47377-05	8,5x13,1	3



Strega su scopa
Witch on broom

art.	dim. cm.	h.
47377-06	11,6x11,7	3



Teschio
Skull

art.	dim. cm.	h.
47377-07	7,9x7,9	3



Halloween set 3 pz
Halloween, set of 3 pcs.

art.	dim. cm.	h.
47377-11	11x10,7	3



ANIMALI - ANIMALS



Ape
Honey bee

art.	dim. cm.	h.
47382-06	11,6x7,9	3

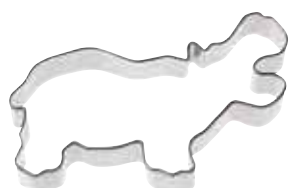

Ippopotamo
Hippo

art.	dim. cm.	h.
47404-04	10,9x6,8	3



Coccinella
Ladybug

art.	dim. cm.	h.
47404-05	8,2x8,1	3



Farfalla
Butterfly

art.	dim. cm.	h.
47371-08	8x7	3



Lumaca
Snail

art.	dim. cm.	h.
47404-02	11,1x5,7	3



Pesce
Fish

art.	dim. cm.	h.
47384-08	8x8	3



Rana
Frog

art.	dim. cm.	h.
47380-08	8x8	3



Gallo
Rooster

art.	dim. cm.	h.
47383-08	8x8	3



Delfino
Dolphin

art.	dim. cm.	h.
47384-01	4,7x8,8	3



Gabbiano
Seagull

art.	dim. cm.	h.
47386-08	11x6	3



Gatto
Cat

art.	dim. cm.	h.
47401-08	8x8	3



Oca
Goose

art.	dim. cm.	h.
47404-08	8x7	3



Orsetto
Teddy bear

art.	dim. cm.	h.
47375-08	8x8	3



Orsetto
Teddy bear

art.	dim. cm.	h.
47375-01	5,7x8,8	3



Cammello
Camel

art.	dim. cm.	h.
47404-01	9,3x8,6	3



Elefante
Elephant

art.	dim. cm.	h.
47404-03	11,8x6,9	3

VARIE - VARIOUS



Quadrifoglio
Four leaf clover

art.	dim. cm.	h.
47374-08	8x8	3



Fiore
Flower

art.	dim. cm.	h.
47374-02	6,7x7,4	3



Tulipano
Tulip

art.	dim. cm.	h.
47374-01	5,5x8,4	3



Cuore
Heart

art.	dim. cm.	h.
47385-08	8x9	3



Due cuori
Two hearts

art.	dim. cm.	h.
47385-01	9,4x5	3



Cavallo a dondolo
Rocking horse

art.	dim. cm.	h.
47381-08	8x5	3



Fiocco
Bow

art.	dim. cm.	h.
47373-02	5,7x7,8	3



Mela
Apple

art.	dim. cm.	h.
47378-01	7,6x8,4	3



Nave pirata
Pirate ship

art.	dim. cm.	h.
47370-03	7,8x8,4	3



Aereo
Airplane

art.	dim. cm.	h.
47370-02	9,3x8,6	3



Locomotiva
Train

art.	dim. cm.	h.
47370-01	9,9x7	3



Semi carte set 4 pz
Suits of cards, set of 4 pcs

art.	dim. cm.	h.
47378-02	7,5x7,5	3





Numeri, set 9 pz
Numbers, set of 9 pcs

art.	cm.	h.
47421-09	6,5	2,5



Lettere, set 26 pz
Letters, set of 26 pcs

art.	cm.	h.
47422-26	6	2,5



Cerchio
Round

art.	cm.	h.	u.pack
47425-01	4	3	6
47425-02	5	3	6
47425-03	6	3	6



Quadro
Square

art.	cm.	h.	u.pack
47425-04	5	3	6
47425-05	6	3	6



Triangolo
Triangle

art.	cm.	h.	u.pack
47425-06	6	3	6



Ovale
Oval

art.	cm.	h.	u.pack
47425-09	7,5x4,5	3	6



Trapezio
Trapeze

art.	cm.	h.	u.pack
47425-08	9x6	3	6



Rettangolo
Rectangle

art.	cm.	h.	u.pack
47425-10	5x3,5	3	6
47425-11	6x5	3	6



Goccia
Drop

art.	cm.	h.	u.pack
47425-26	9	3	6



Esagono
Hexagon

art.	cm.	h.	u.pack
47425-29	5	3	6
47425-30	6	3	6



Cuore
Heart

art.	cm.	h.	u.pack
47425-32	6,5	3	6



Quadro
Square

art.	cm.	h.	u.pack
47426-01	8	4,5	6



Rettangolo
Rectangle

art.	cm.	h.	u.pack
47426-07	12x6	4,5	1



Tagliapasta per doughnuts inox
Doughnut cutter, stainless steel
Donut-Ausstecher, Edelstahl Rostfrei
Coupe-donuts, inox
Cortadonuts, inox

art.	ø mm.	h.
47388-06	65-25	20
47388-07	70-30	17
47388-08	80-40	20



Tagliapaste stelle, inox
Cinnamon star cutter, stainless steel
Zimstern-Ausstecher, Edelstahl Rostfrei
Coupe-étoiles, inox
Cortapasta Esterella, inox

art.	l. mm.	h.
47377-15	50	97

Meccanismo a molla . - Spring mechanism



Ferro di cavallo, banda stagnata
Horseshoe, tin plate
Hufeisen, Weißblech
Fer à cheval, fer blanc
Herradura, hojalata

art.	dim. mm.	h.
47377-12	7x6	2

P TAGLIAPASTA - CUTTERS PA⁺plus



Rotondo
Round

art.	ø cm.	h.
12943-03	3	3,5
12943-05	5	3,5
12943-07	7	3,5
12943-08	8	3,5
12943-10	10	3,5
12943-12	12	3,5



Rotondo festonato
Round, fluted

art.	ø cm.	h.
12944-03	3	3,5
12944-05	5	3,5
12944-07	7	3,5
12944-08	8	3,5
12944-10	10	3,5
12944-12	12	3,5



Ovale festonato
Oval, fluted

art.	dim. cm.	h.
12947-02	5,5x3,5	3,5
12947-03	7x4	3,5
12947-04	8,5x5	3,5
12947-05	10x6	3,5
12947-06	11x7	3,5
12947-07	13x5	3,5



Scatola tagliapasta rotondi, 6 pz
Set 6 pcs round pastry cutters

art.
12943-13



Scatola tagliapasta rotondi festonati, 6 pz
Set 6 pcs fluted round pastry cutters

art.
12944-13



Scatola tagliapasta ovali festonati, 6 pz
Set 6 pcs fluted oval pastry cutters

art.
12947-13



AGRIFOGLIO/HOLLY

Tagliapasta con espulsore, set 3 pz
Dough plunger cutters with extractor
Ausstechformen mit Auswerfer
Emportes-pièces
Cortadore

art.	ø cm.	h.
47622-04	3x4,5	5



MARGHERITE/DAISY

Tagliapasta con espulsore, set 4 pz
Dough plunger cutters with extractor
Ausstechformen mit Auswerfer
Emportes-pièces
Cortadore

art.	ø cm.
47622-26	1,2 - 2 - 2,8 - 3,5



PETUNIE/PETUNIA

Tagliapasta con espulsore, set 3 pz
Dough plunger cutters with extractor
Ausstechformen mit Auswerfer
Emportes-pièces
Cortadores

art.	ø cm.	h.
47622-01	3x5	5



FIORE/FLOWER

Tagliapasta con espulsore, set 3 pz
Dough plunger cutters with extractor
Ausstechformen mit Auswerfer
Emportes-pièces
Cortadores

art.	ø cm.	h.
47622-02	2,5	5



**FOGLIA DI ROSA
ROSE LEAF**

Tagliapasta con espulsore, set 3 pz
Dough plunger cutters with extractor
Ausstechformen mit Auswerfer
Emportes-pièces
Cortadores

art.	ø cm.	h.
47622-03	3x5	5



Set 9 tagliapasta, inox
Set of 9 cutters, stainless steel
Satz 9 Ausstechformen, Edelstahl Rostfrei
Set 9 découpoirs, inox
Juego 9 cortadores, inox

art. h. mm.
47837-09 5



Coltello per marzapane, poliammide
Almont past knife, PA
Marzipan-Messer, PA
Couteau à pâte d'amande, PA
Cuchillo, PA

art. l. cm.
47630-28 16,5



Set 15 pezzi per marzapane, PP
Marzipan set, 15 pcs, PP
Marzipan-Satz, 15 Stk., PP
Set 15 outils à pâte d'amandes, PP
Juego 15 piezas, PP

art.
47631-12



Set 10 forchettine pralineria, inox
Set of 10 pcs dipping forks, s/s
Pralinen Gabelchen, 10-Stk., Edelstahl
Jeu de 10 ébauchoirs, inox
Juego 10 tenedores, inox

art.
47833-10



Set 4 forchettine pralineria, inox
Set of 4 pcs dipping forks, s/s
Pralinen Gabelchen, 4-Stk., Edelstahl
Jeu de 4 ébauchoirs, inox
Juego 4 tenedores, inox

art.
47833-04



Set 8 pezzi per marzapane, plastica
Plastic marzipan set, 8 pcs
Marzipan-Satz, 8 Stk.
Set 8 outils en plastique à pâte d'amandes
Juego 8 piezas, plástico

art.
47631-08



Set 2 Cucchiari Decorazione
Set 2 Decorating Spoons
Satz 2 Dekoration-Löffel
Set 2 Cuillères Pour Décorer
2 Cucharas Para Decoración

art. l. cm.
47831-02 19-23



Per decorazioni su piatti con salse, panna, caramello, purea, ecc., ecc. Piccolo per preparazioni dolci, grande per salate. - To make decorations on dishes with sauces, cream, caramel, puree, etc. Small spoon to decorate sweets, a larger one for savory preparations.





Set 12 bocchette unipezzo, inox
 Set 12 pcs tubes, one piece, stainless steel
 12 Stk. Tüllen, Edelstahl Rostfrei, aus einem Stück gezogen
 Set 12 pcs douilles monobloc, inox
 Surtido 12 boquillas monobloc, inox

art.	ø mm.	base/bottom ø mm.
47357-20	1x 0,6-1,2-1,5-1,9-2,4-3 3,6-4,8-5,6-6,4-6,8-7,6	18

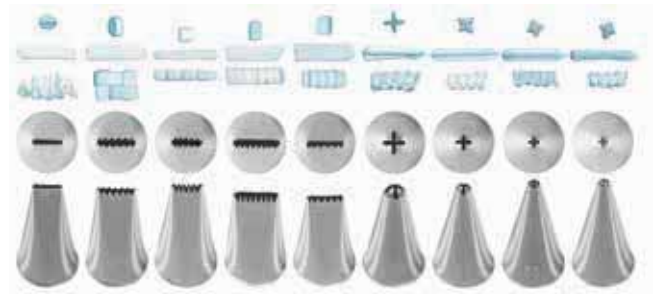

Set 9 bocchette unipezzo, inox
 Set 9 pcs tubes, one piece, stainless steel
 9 Stk. Tüllen, Edelstahl Rostfrei, aus einem Stück gezogen
 Set 9 pcs douilles monobloc, inox
 Surtido 9 boquillas monobloc, inox

art.	base/bottom ø mm.
47357-24	18



Set 7 bocchette unipezzo, inox
 Set 7 pcs tubes, one piece, stainless steel
 7 Stk. Tüllen, Edelstahl Rostfrei, aus einem Stück gezogen
 Set 7 pcs douilles monobloc, inox
 Surtido 7 boquillas monobloc, inox

art.	ø mm.	base/bottom ø mm.
47357-21	1x 1,7-2,2-3,5-4,2-5-5,5-7	18



Set 8 bocchette unipezzo, inox
 Set 8 pcs tubes, one piece, stainless steel
 8 Stk. Tüllen, Edelstahl Rostfrei, aus einem Stück gezogen
 Set 8 pcs douilles monobloc, inox
 Surtido 8 boquillas monobloc, inox

art.	ø mm.	base/bottom ø mm.
47357-22	1x 1-1,5-1,8-2,6-3-3,4-2,5-7	18

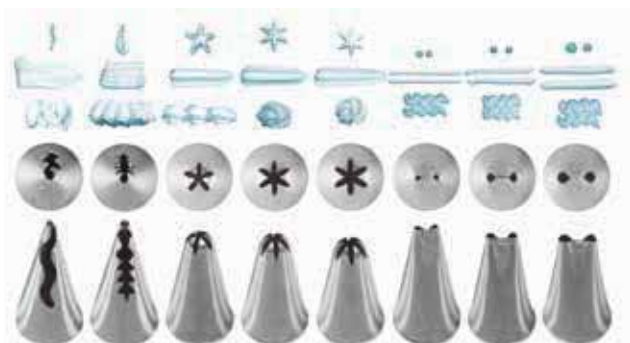

Set 8 bocchette unipezzo, inox
 Set 8 pcs tubes, one piece, stainless steel
 8 Stk. Tüllen, Edelstahl Rostfrei, aus einem Stück gezogen
 Set 8 pcs douilles monobloc, inox
 Surtido 8 boquillas monobloc, inox

art.	base/bottom ø mm.
47357-23	18

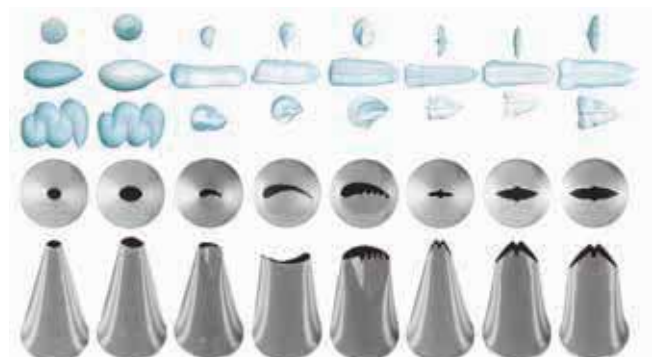

Set 8 bocchette unipezzo, inox
 Set 8 pcs tubes, one piece, stainless steel
 8 Stk. Tüllen, Edelstahl Rostfrei, aus einem Stück gezogen
 Set 8 pcs douilles monobloc, inox
 Surtido 8 boquillas monobloc, inox

art.	base/bottom ø mm.
47357-25	18

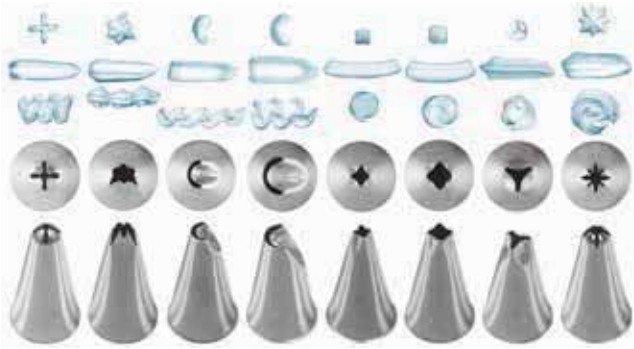

Set 8 bocchette unipezzo, inox
Set 8 pcs tubes, one piece, stainless steel
8 Stk. Tüllen, Edelstahl Rostfrei, aus einem Stück gezogen
Set 8 pcs douilles monobloc, inox
Surtido 8 boquillas monobloc, inox

art. base/bottom ø mm.
47357-26 18

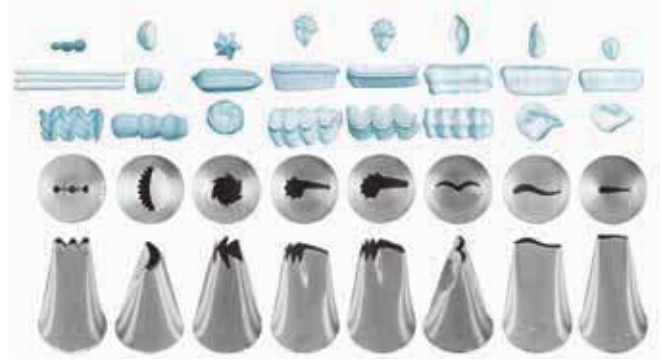

Set 8 bocchette unipezzo, inox
Set 8 pcs tubes, one piece, stainless steel
8 Stk. Tüllen, Edelstahl Rostfrei, aus einem Stück gezogen
Set 8 pcs douilles monobloc, inox
Surtido 8 boquillas monobloc, inox

art. base/bottom ø mm.
47357-27 18



Set 8 bocchette unipezzo, inox
Set 8 pcs tubes, one piece, stainless steel
8 Stk. Tüllen, Edelstahl Rostfrei, aus einem Stück gezogen
Set 8 pcs douilles monobloc, inox
Surtido 8 boquillas monobloc, inox

art. base/bottom ø mm.
47357-28 18



Set 8 bocchette unipezzo, inox
Set 8 pcs tubes, one piece, stainless steel
8 Stk. Tüllen, Edelstahl Rostfrei, aus einem Stück gezogen
Set 8 pcs douilles monobloc, inox
Surtido 8 boquillas monobloc, inox

art. base/bottom ø mm.
47357-29 18

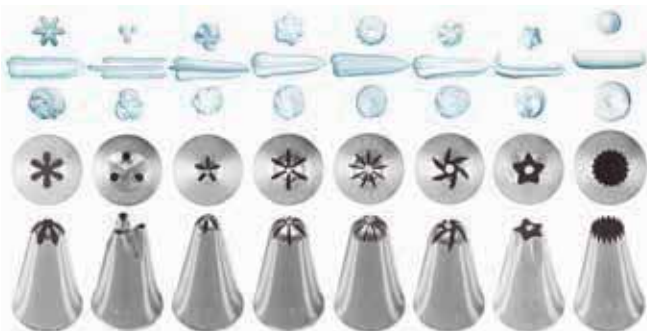

Set 8 bocchette unipezzo, inox
Set 8 pcs tubes, one piece, stainless steel
8 Stk. Tüllen, Edelstahl Rostfrei, aus einem Stück gezogen
Set 8 pcs douilles monobloc, inox
Surtido 8 boquillas monobloc, inox

art. base/bottom ø mm.
47357-30 18

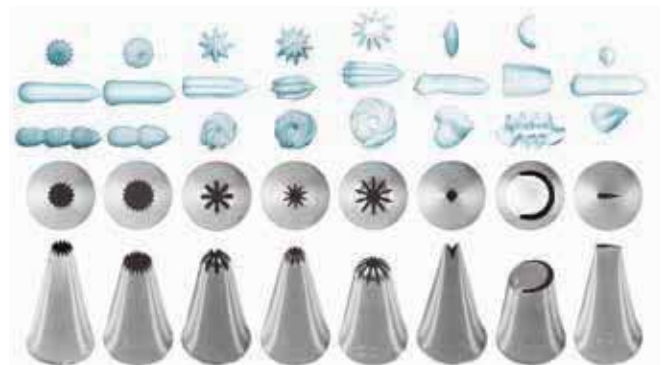

Set 8 bocchette unipezzo, inox
Set 8 pcs tubes, one piece, stainless steel
8 Stk. Tüllen, Edelstahl Rostfrei, aus einem Stück gezogen
Set 8 pcs douilles monobloc, inox
Surtido 8 boquillas monobloc, inox

art. base/bottom ø mm.
47357-31 18

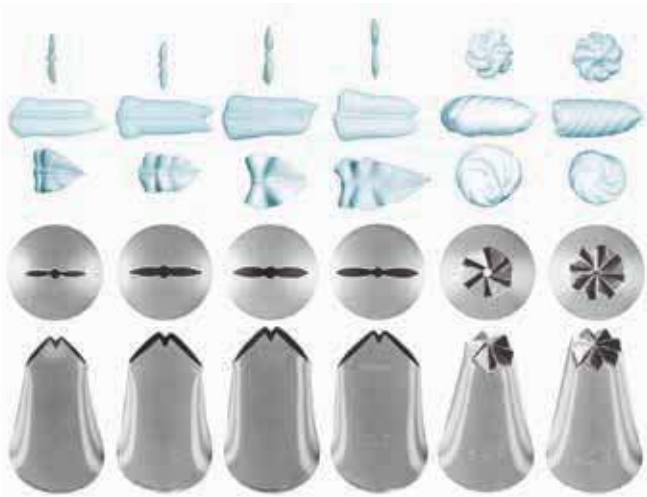

Set 6 bocchette unipezzo, inox
 Set 6 pcs tubes, one piece, stainless steel
 6 Stk. Tüllen, Edelstahl Rostfrei, aus einem Stück gezogen
 Set 6 pcs douilles monobloc, inox
 Surtido 6 boquillas monobloc, inox

art. base/bottom \varnothing mm.
 47357-06 25

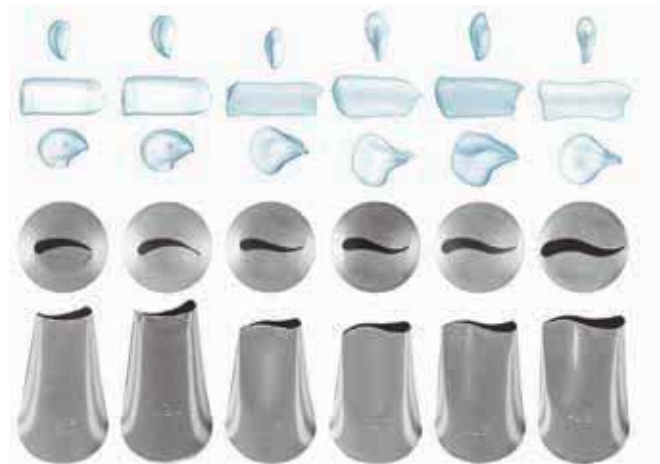

Set 6 bocchette unipezzo, inox
 Set 6 pcs tubes, one piece, stainless steel
 6 Stk. Tüllen, Edelstahl Rostfrei, aus einem Stück gezogen
 Set 6 pcs douilles monobloc, inox
 Surtido 6 boquillas monobloc, inox

art. base/bottom \varnothing mm.
 47357-07 25

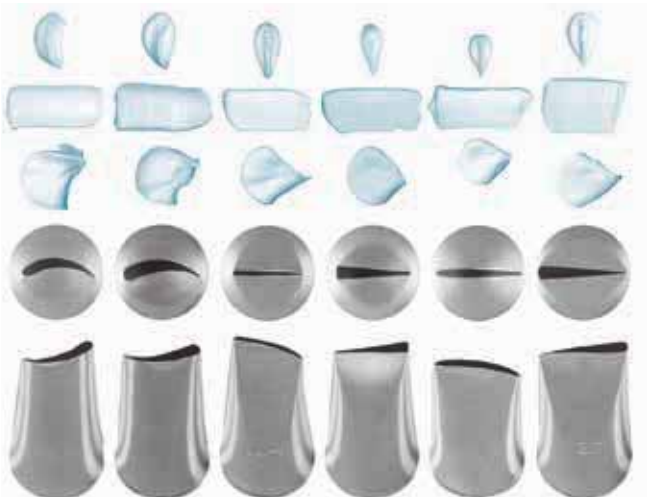

Set 6 bocchette unipezzo, inox
 Set 6 pcs tubes, one piece, stainless steel
 6 Stk. Tüllen, Edelstahl Rostfrei, aus einem Stück gezogen
 Set 6 pcs douilles monobloc, inox
 Surtido 6 boquillas monobloc, inox

art. base/bottom \varnothing mm.
 47357-08 25

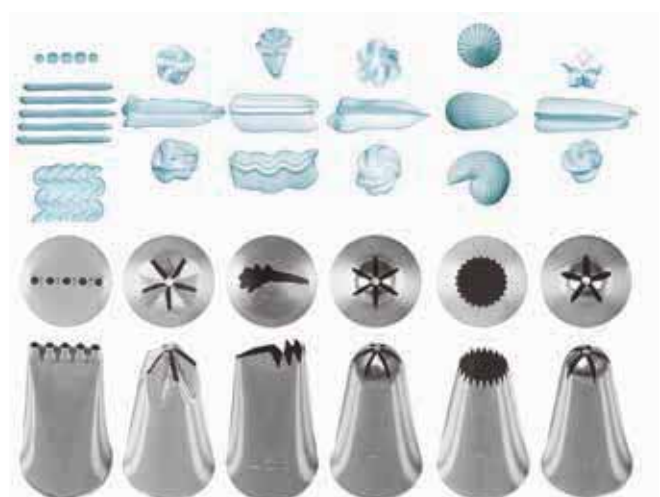

Set 6 bocchette unipezzo, inox
 Set 6 pcs tubes, one piece, stainless steel
 6 Stk. Tüllen, Edelstahl Rostfrei, aus einem Stück gezogen
 Set 6 pcs douilles monobloc, inox
 Surtido 6 boquillas monobloc, inox

art. base/bottom \varnothing mm.
 47357-09 25

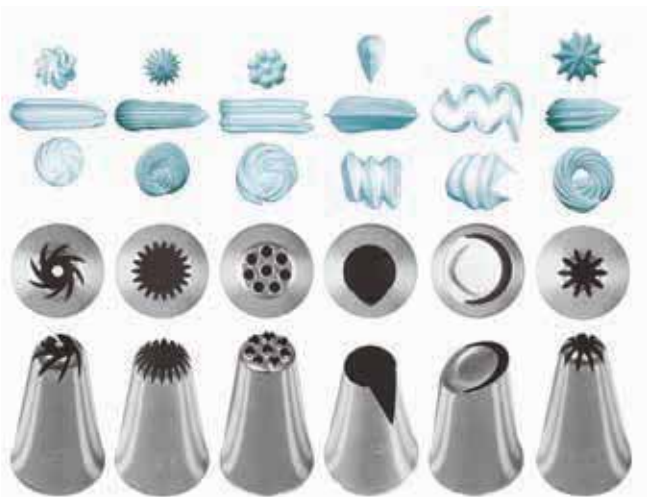

Set 6 bocchette unipezzo, inox
 Set 6 pcs tubes, one piece, stainless steel
 6 Stk. Tüllen, Edelstahl Rostfrei, aus einem Stück gezogen
 Set 6 pcs douilles monobloc, inox
 Surtido 6 boquillas monobloc, inox

art. base/bottom \varnothing mm.
 47357-10 25

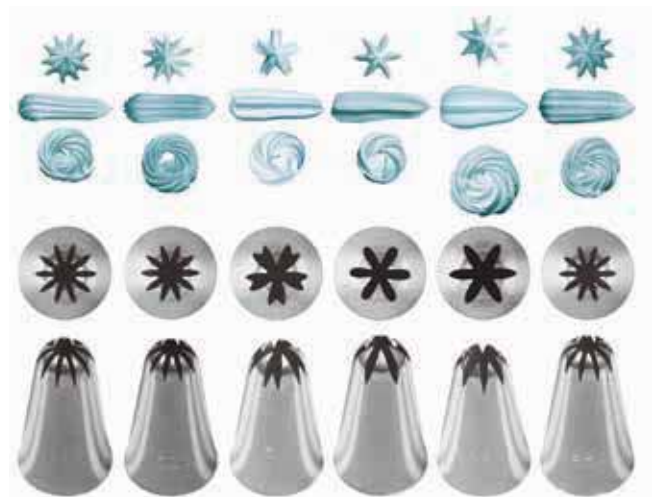

Set 6 bocchette unipezzo, inox
 Set 6 pcs tubes, one piece, stainless steel
 6 Stk. Tüllen, Edelstahl Rostfrei, aus einem Stück gezogen
 Set 6 pcs douilles monobloc, inox
 Surtido 6 boquillas monobloc, inox

art. base/bottom \varnothing mm.
 47357-11 25

PASTICCERIA PASTRY UTENSILS

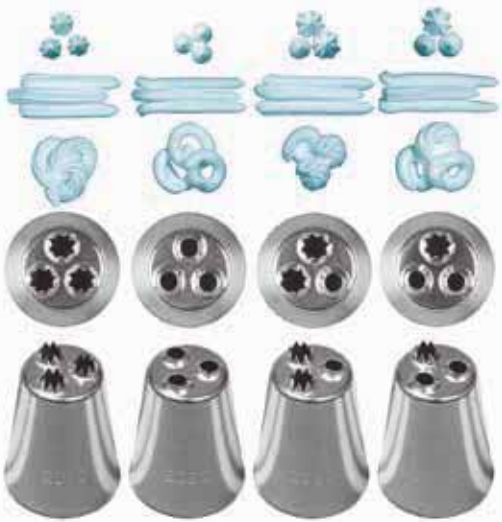

Set 4 bocchette unipezzo, inox
 Set 4 pcs tubes, one piece, stainless steel
 4 Stk. Tüllen, Edelstahl Rostfrei, aus einem Stück gezogen
 Set 4 pcs douilles monobloc, inox
 Surtido 4 boquillas monobloc, inox

art. base/bottom ø mm.
 47357-01 31

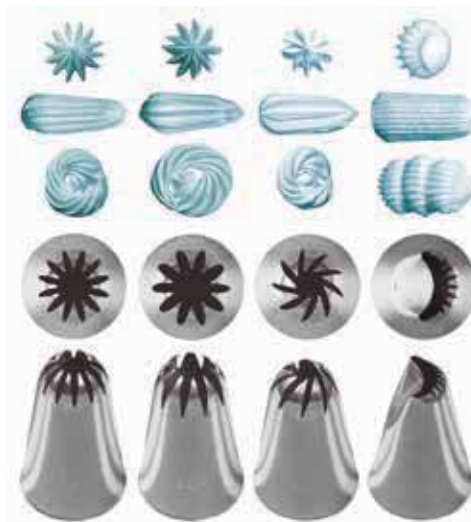

Set 4 bocchette unipezzo, inox
 Set 4 pcs tubes, one piece, stainless steel
 4 Stk. Tüllen, Edelstahl Rostfrei, aus einem Stück gezogen
 Set 4 pcs douilles monobloc, inox
 Surtido 4 boquillas monobloc, inox

art. base/bottom ø mm.
 47357-02 2x 31 - 2x 36



Set 7 bocchette unipezzo, inox
 Set 7 pcs tubes, one piece, stainless steel
 7 Stk. Tüllen, Edelstahl Rostfrei, aus einem Stück gezogen
 Set 7 pcs douilles monobloc, inox
 Surtido 7 boquillas monobloc, inox

art. base/bottom ø mm.
 47357-03 31



Set 3x2 bocchette, inox
 Set 3x2 tubes, stainless steel
 3x2 Stk. Tüllen, Edelstahl Rostfrei
 Set 3x2 pcs douilles, inox
 Juego 3x2 boquillas, inox

art.	base/bottom ø mm.	punte stars	l. mm. width
47350-01	2x 25	6	17,0
	2x 31	6	21,5
434	2x 36	6	26,5



Set 3x2 bocchette, inox
 Set 3x2 tubes, stainless steel
 3x2 Stk. Tüllen, Edelstahl Rostfrei
 Set 3x2 pcs douilles, inox
 Juego 3x2 boquillas, inox

art.	base/bottom ø mm.	punte stars	l. mm. width
47351-01	2x 31	6	11
	2x 31	8	13
	2x 36	9	15



Set 3x2 bocchette, inox
 Set 3x2 tubes, stainless steel
 3x2 Stk. Tüllen, Edelstahl Rostfrei
 Set 3x2 pcs douilles, inox
 Juego 3x2 boquillas, inox

art.	base/bottom ø mm.	punte stars	l. mm. width
47352-01	2x 31	6	5
	2x 31	8	6
	2x 36	9	8

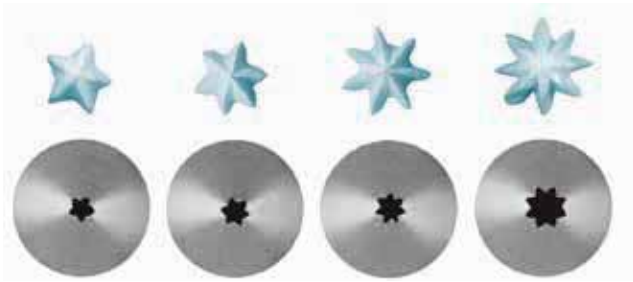

Set 6 bocchette, inox
 Set 6 pcs tubes, stainless steel
 6 Stk. Tüllen, Edelstahl Rostfrei
 Set 6 pcs douilles, inox
 Juego 6 boquillas, inox

art.	ø mm.	punta/point
47208-01	3,0	5
47208-02	3,0	6
47208-03	3,5	7
47208-04	5,0	8



Set 6 bocchette, inox
 Set 6 pcs tubes, stainless steel
 6 Stk. Tüllen, Edelstahl Rostfrei
 Set 6 pcs douilles, inox
 Juego 6 boquillas, inox

art.	ø mm.	punta/point
47208-05	5,0	5
47208-06	5,0	6
47208-07	6,0	7
47208-08	7,0	8



Set 6 bocchette, inox
 Set 6 pcs tubes, stainless steel
 6 Stk. Tüllen, Edelstahl Rostfrei
 Set 6 pcs douilles, inox
 Juego 6 boquillas, inox

art.	ø mm.	punta/point
47208-09	7,0	5
47208-10	7,0	6
47208-11	7,0	7
47208-12	9,0	8



Set 6 bocchette, inox
 Set 6 pcs tubes, stainless steel
 6 Stk. Tüllen, Edelstahl Rostfrei
 Set 6 pcs douilles, inox
 Juego 6 boquillas, inox

art.	ø mm.	punta/point
47208-13	11	5
47208-14	11	6
47208-15	11	7
47208-16	11	8



Set 6 bocchette, inox
 Set 6 pcs tubes, stainless steel
 6 Stk. Tüllen, Edelstahl Rostfrei
 Set 6 pcs douilles, inox
 Juego 6 boquillas, inox

art.	ø mm.	punta/point
47208-17	13	5
47208-18	13	6
47208-19	13	7
47208-20	13	8

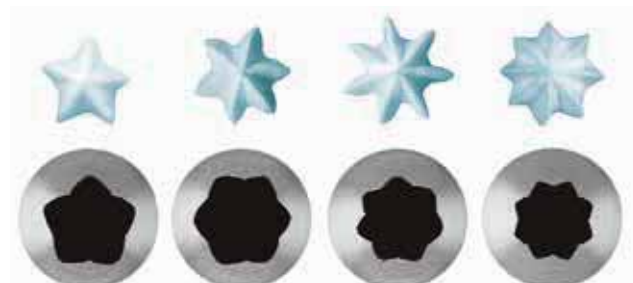

Set 6 bocchette, inox
 Set 6 pcs tubes, stainless steel
 6 Stk. Tüllen, Edelstahl Rostfrei
 Set 6 pcs douilles, inox
 Juego 6 boquillas, inox

art.	ø mm.	punta/point
47208-21	18	5
47208-22	18	6
47208-23	18	7
47208-24	18	8

PASTICCERIA PASTRY UTENSILS



Set 6 bocchette, inox
Set 6 pcs tubes, stainless steel
6 Stk. Tüllen, Edelstahl Rostfrei
Set 6 pcs douilles, inox
Juego 6 boquillas, inox

art.	ø mm.
47353-02	2
47353-04	4
47353-06	6
47353-08	8
47353-10	10
47353-12	12
47353-14	14
47353-16	16
47353-18	18
47353-20	20
47353-22	22
47353-24	24



Set 6 bocchette, inox
Set 6 pcs tubes, stainless steel
6 Stk. Tüllen, Edelstahl Rostfrei
Set 6 pcs douilles, inox
Juego 6 boquillas, inox

art.	ø mm.	punte/stars
47354-02	2	6
47354-04	4	6
47354-06	6	6
47354-08	8	6
47354-10	10	6
47354-12	12	7
47354-14	14	8
47354-16	16	9
47354-18	18	10



Set 6 bocchette, inox
Set 6 pcs tubes, stainless steel
6 Stk. Tüllen, Edelstahl Rostfrei
Set 6 pcs douilles, inox
Juego 6 boquillas, inox

art.	ø mm.	punte/stars
47355-02	2,5	6
47355-04	4,0	6
47355-06	6,0	6
47355-08	8,0	7
47355-10	10,0	8
47355-12	12,0	10



Set 6 bocchette, inox
Set 6 pcs tubes, stainless steel
6 Stk. Tüllen, Edelstahl Rostfrei
Set 6 pcs douilles, inox
Juego 6 boquillas, inox

art.	ø mm.	punte/stars
47356-02	2,0	5
47356-04	4,0	9
47356-06	5,5	9
47356-08	7,0	10
47356-10	8,5	12
47356-12	13,0	15
47356-14	14,5	16
47356-16	16,0	17
47356-18	17,5	18



Set 6 bocchette, inox
Set 6 pcs tubes, stainless steel
6 Stk. Tüllen, Edelstahl Rostfrei
Set 6 pcs douilles, inox
Juego 6 boquillas, inox

art.	ø mm.
47207-20	20
47207-25	25
47207-30	30



Bocchetta a imbuto, inox
Bismark tube, stainless steel
Fülltülle, Edelstahl Rostfrei
Douille à chou, inox
Boquilla para relleno, inox

art.	ø mm.	l.	u.pack
47127-04	4	90	10
47127-06	6	75	10
47127-08	8	90	10



Bocchetta decorativa, inox
Nozzle, stainless steel
Spritztülle, Edelstahl Rostfrei
Douille deco, inox
Boquilla, inox



art.	ø mm.	h.	top ø
47357-50	55	60	31



Bocchetta decorativa, inox
Nozzle, stainless steel
Spritztülle, Edelstahl Rostfrei
Douille deco, inox
Boquilla, inox



art.	ø mm.	h.	top ø
47357-51	55	56	31



Bocchetta decorativa, inox
Nozzle, stainless steel
Spritztülle, Edelstahl Rostfrei
Douille deco, inox
Boquilla, inox



art.	ø mm.	h.	top ø
47357-40	32	60	22
47357-41	32	57	22
47357-42	32	57	22
47357-43	32	57	22
47357-44	32	57	22

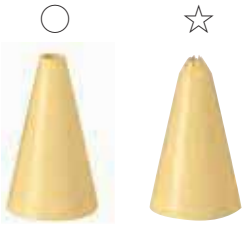

Set 6 bocchette, PP
 Set of 6 PP nozzles
 6 Stk.-Tüllen, PP
 6 douilles, PP
 6 boquillas, PP

art.	pz/pcs	ø mm.
47214-86	6	5-7-9-11-13-15
47215-86	6	3-5-7-9-11-13



Set 8 bocchette, PP
 Set of 8 assorted PP nozzles
 8 Stk.-Tüllensortiment, PP
 8 douilles assorties, PP
 Surtido 8 boquillas, PP

art.
47216-88



Set 12 bocchette assortite, PP
 Set of 12 assorted PP nozzles
 12 Stk.-Tüllensortiment, PP
 12 douilles assorties, PP
 Surtido 12 boquillas, PP

art.	pz/pcs	ø mm.
47618-10	12	2>10
47618-20	12	10>20

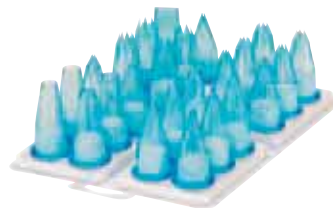

Bocchette assortite, PC
 Set of assorted PC nozzles
 Tüllensortiment, Polykarbonat
 Douilles assorties, polycarbonate
 Surtido boquillas, PC

art.	pz/pcs
47250-12	12
47250-24	24



Bocchette floreali 12 pz, inox
 Flower nozzles 12 pcs, stainless steel
 Spritztüllen 12 Stk, Edelstahl Rostfrei
 Douille fleurs 12 pcs, inox
 Boquillas florales 12 pz, inox

art.
47357-38

N



Set 29 pz, inox
 Set 29 pcs, stainless steel
 29 Stk.- Sortiment, Edelstahl Rostfrei
 Set 29 pcs, inox
 Conjunto 29 boquillas inox

art.
47219-29

26 bocchette, 2 chiodi per fiori e un adattatore standard. - 26 decoration tubes, 2 flower nails and a standard coupler.



Set 38 pz, inox
 Set 38 pcs, stainless steel
 38 Stk.- Sortiment, Edelstahl Rostfrei
 Set 38 pcs, inox
 Conjunto 38 boquillas inox

art.
47219-38

35 bocchette, 1 ad imbuto, un adattatore medio e uno grande. - 35 decoration tubes including 1 fritter tube, a medium coupler and a large coupler.



Set 55 pz, inox
 Set 55 pcs, stainless steel
 55 Stk.- Sortiment, Edelstahl Rostfrei
 Set 55 pcs, inox
 Conjunto 55 boquillas inox

art.
47219-55

52 bocchette, 2 chiodi per fiori e un adattatore standard. - 52 decoration tubes, 2 flower nails and a standard coupler.

PASTICCERIA PASTRY UTENSILS



Set bocchette assortite, BPA-Free
Set of assorted nozzles
Tüllensortiment
Douilles assorties
Surtido boquillas

art. h. cm. pz-pcs
47251-00 3-3,5 13

Trasparenti, lavabili in lavastoviglie. 8 bocchette ø mm. 1/2/3/5/7/9/13/15 - 2 adattatori + 2 tappi - 1 bruschino. - Crystal clear, dishwasher proof. 8 tubes ø mm. 1/2/3/5/7/9/13/15. 2 adapters + 2 lids - 1 brush.

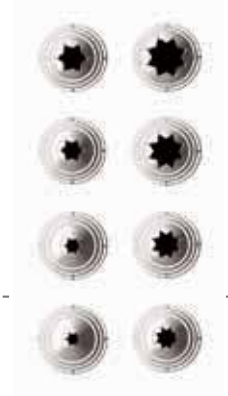

Set bocchette assortite, BPA-Free
Set of assorted nozzles
Tüllensortiment
Douilles assorties
Surtido boquillas

art. h. cm. pz-pcs
47251-01 3-3,5 13

Trasparenti, lavabili in lavastoviglie. 8 bocchette foro stella ø mm. 4/5/7/9 (6 punte) 7/9/11/13 (8 punte) - 2 adattatori + 2 tappi - 1 bruschino. Crystal clear, dishwasher proof. 8 star tubes ø mm. 4/5/7/9 (6 points) 7/9/11/13 (8 points) - 2 adapters + 2 lids - 1 brush.



Set bocchette assortite, BPA-Free
Set of assorted nozzles
Tüllensortiment
Douilles assorties
Surtido boquillas

art. h. cm. pz-pcs
47251-02 3-3,5 13

Trasparenti, lavabili in lavastoviglie. 8 bocchette - 1 bocchetta a imbuto - 2 adattatori + 2 tappi. - Crystal clear, dishwasher proof. 8 tubes - 1 bismark tube - 2 adapters + 2 lids.

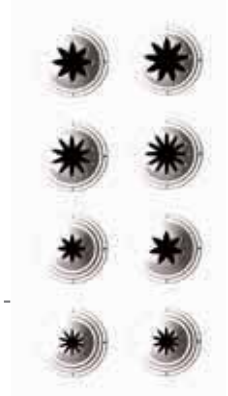

Set bocchette assortite, BPA-Free
Set of assorted nozzles
Tüllensortiment
Douilles assorties
Surtido boquillas

art. h. cm. pz-pcs
47251-03 3-3,5 13

Trasparenti, lavabili in lavastoviglie. 8 bocchette foro stella ø mm. 4,5/5,5/6/7,5/8/9/10 - 2 adattatori + 2 tappi - 1 bruschino. Crystal clear, dishwasher proof. 8 star tubes ø mm. 4,5/5,5/6/7,5/8/9/10 - 2 adapters + 2 lids - 1 brush.



Adattatore per bocchette, STANDARD
External piping tip adapter
Adapter für Spritztüllen
Adaptateur à douilles
Adaptador para boquillas

art. ø mm.
47212-01 18



Adattatore per bocchette, MEDIUM
External piping tip adapter
Adapter für Spritztüllen
Adaptateur à douilles
Adaptador para boquillas

art. ø mm.
47212-02 25-31



Adattatore per bocchette, LARGE
External piping tip adapter
Adapter für Spritztüllen
Adaptateur à douilles
Adaptador para boquillas

art. ø mm.
47212-03 36

Pratici adattatori per cambiare facilmente bocchetta. - Practical adapters for an easy nozzle change.

PASTICCERIA PASTRY UTENSILS
PREPARAZIONE PREPARATION TOOLS



N

Adattatori per bocchette, 2 pz
Nozzles adapter, 2 pcs
Spritztüllen-Adapter, 2 Stk
Adaptateurs à douilles, 2 pièces
Adaptadores boquillas, 2 piezas

art.

47212-05

Per decorazioni a 2 o 3 colori. - To prepare decorations with 2 or 3 colours.
Adatto a bocchette / Suitable for piping tips: Ø30 h. 50 mm.



Bruscino per bocchette
Pastry tube brush
Tüllen-Bürste
Brosse à douilles
Cepillo para boquillas

art. ø cm. l. u.pack

47200-01 0,8 10,0 6

47200-02 0,5-2,4 12,5 6



Cannoli, inox
Cream roll molds, stainless steel
Sahnerolle, konisch/gerade, Edelstahl
Rouleau à fromage, inox
Rodillos queso, inox

art. ø mm. l. u.pack

47020-15 15 92 10

47020-20 22 142 10

47020-30 10-25 139 10

47020-35 20-25 171 10



Cornetti, inox
Cream horn molds, stainless steel
Schillerlockenform, Edelstahl Rostfrei
Moulet à cornet, inox
Moldes para conos, inox

art. ø mm. l. u.pack

47021-35 34 110 10

47021-45 47 161 10



Cornetti, PA 6
Cream horn molds, plastic
Schillerlockenform, Kunststoff
Moulet à cornet, plastique
Moldes para conos, plástico

art. dim. mm. u.pack

47021-30 30x120 10

Materiale plastico utilizzabile in forno.
Plastic material, oven ready.



P

Kit decoro 8 pezzi
Decorating set 8 pcs
Dekorations-Set, 8-teilig
Set 8 pcs à décorer
Juego 8 piezas para decorar

art.

47120-01

6 bocchette piccole, un adattatore standard e un sacchetto decoro 35 cm.
6 small tubes, a standard coupler and a decoration bag cm. 35



P

Kit decoro 8 pezzi
Decorating set 8 pcs
Dekorations-Set, 8-teilig
Set 8 pcs à décorer
Juego 8 piezas para decorar

art.

47120-02

6 bocchette medie, un adattatore medio e un sacchetto 40 cm.
6 medium tubes, a medium coupler and a decoration bag cm. 40.



Levafiori, inox
Flower lifter, stainless steel
Rosenheber, Edelstahl Rostfrei
Enlève fleurs, inox
Aparato quita flores, inox

art. ø mm. l. u.pack

47207-40 34 110 4



Set 10 chiodi per fiori, inox
Set 10 flower nails, s/s
10 Stk. Blumenstempel, Edelstahl
Set 10 clous à fleurs, inox
Surtido 10 clavos para flores, inox

art. ø mm. art. ø mm.

47207-01 20 47207-06 36

47207-02 30 47207-08 45

47207-03 35 47207-09 33

47207-04 33 47207-10 40

47207-05 40





Lavare a mano con acqua calda, immergere brevemente in acqua bollente. - Hand wash with hot running water, short dipping into boiling water.

Sacchetto per decorare
Icing bag
Spritzbeutel
Sac à dresser
Mangas para decorar

art.	h. cm	u.pack
47106-28	28	6
47106-34	34	6
47106-40	40	6
47106-46	46	6
47106-50	50	6
47106-55	55	6
47106-60	60	6
47106-65	65	6
47106-70	70	6
47106-75	75	6

Fibra sintetica con rivestimento a strati in plastica impermeabile. - Synthetic fibre with multi-layer water-proof plastic coating.

Sacchetto per decorare
Icing bag
Spritzbeutel
Sac à dresser
Mangas para decorar

art.	h. cm	u.pack
47105-28	28	6
47105-34	34	6
47105-40	40	6
47105-46	46	6
47105-50	50	6
47105-55	55	6
47105-60	60	6
47105-65	65	6
47105-70	70	6
47105-75	75	6

Con punta rinforzata, orlo e gancio. Cotone con rivestimento a strati in plastica impermeabile. - With reinforced tip, seam and hanger. Cotton with multi-layer water-proof plastic coating.

Sacchetto per decorare
Icing bag
Spritzbeutel
Sac à dresser
Mangas para decorar

art.	h. cm	u.pack
47119-30	30	6
47119-35	35	6
47119-40	40	6
47119-45	45	6
47119-50	50	6
47119-60	60	6

Con punta rinforzata, orlo e gancio. Poliuretano con rivestimento in nylon. Saldatura ad alta frequenza. - With reinforced tip, seam and hanger. Polyurethane with nylon coating. High frequency electric seaming.



Sacchetti per decorare, monouso, PE
Disposable icing bags, PE
Einwegspritzbeutel, PE
Poches en polyéthylène, jetables
Mangas desechables

art.	my	h. cm	box px/pcs
47118-30	80	30	100
47118-40	80	40	100
47118-55	80	55	100
47118-65	80	65	100

Sacchetti usa e getta. Ruvido all'esterno per assicurare una salda impugnatura, liscio all'interno per facilitare la fuoriuscita del prodotto.
Disposable icing bags. Rough outside to ensure a firm grip, smooth inside to facilitate the product release.

Sacchetto per decorare, poliuretano
Icing bag, polyurethane
Spritzbeutel, Polyurethan
Sac à dresser, polyuréthane
Mangas para decorar, poliuretano

art.	h. cm
47112-34	34
47112-45	45
47112-50	50

Realizzato in gomma alimentare. Non trasuda, anche quando si utilizzano composti grassi, garantisce grande sensibilità, morbido e maneggevole. Facile da pulire, si può mettere in lavastoviglie. Non assorbe odori. Ottimo grip antiscivolo. Resistente alle sollecitazioni di pressione con composti molto duri (non deforma lateralmente).
Made with food rubber. It does not sweat, even with fat compounds. Extremely soft and handy and perfectly welded in the joints to avoid infiltration of product. Very easy to clean, dishwasher-safe. Perfect antislip grip. High resistance to pressure stress also with hard compounds (it does not warp).

Clip chiudi sacco, PP
Bag clip
Verschluss-Clip
Clip ferme sachet
Pinza cierra bolsas

art.	cm.	pz/pcs
42908-14	14	3
42908-24	24	1

Idenei ad uso in freezer, lavastoviglie e microonde. Per alimenti, senza BPA.
Freezer, dishwasher and microwave safe. Safe to use with food, BPA free.



Sacchetti per decorare, monouso, PE
 Disposable icing bags, PE
 Einwegspritzbeutel, PE
 Poches en polyéthylène, jetables
 Mangas desechables

art.	my	h. cm	l. cm.	box pz/pcs
47111-30	90	30	16,0	100
47111-40	90	40	22,0	100
47111-46	90	46	23,0	100
47111-55	90	55	27,5	100



Sacchetto per decorare doppio
 Double pastry bag
 Doppeldressierbeutel
 Sac à dresser, double
 Mangas para decorar, doble

art.	dim. mm.	my	pz/pcs
47104-45	455x305	70	75

Monouso - Disposable



Sac a poche doppio comparto per utilizzare due diversi ingredienti. Realizzato in PE, multistrato, superficie interna di setosa per ottimizzare il flusso del prodotto, trasparente, igienico, punta chiusa, può essere utilizzato senza bocchette, cucitura ad alta resistenza, scatola dispenser. - **Double-Compartmented pastry bag with a partition down in the middle, best for using two different ingredients. Made of PE, multiple layers, silky inner surface for maximum product flow, bundle, transparent, hygienic, closed tip, can be used without tube for decorating purposes, seam with high tensile strength; box dispenser.**



Espositore sacchetti/bocchette, inox
 Icing bags & nozzles wall rack, s/s
 Spritzbeutel-/ u. Tüllenaufhänger, E. R.
 Séchoir à poche et douilles, inox
 Secador mangas y boquillas, inox

art.	dim. cm.	h.
47113-03	50x42	50



Espositore per sacchetti, inox
 Wall rack for icing bags, s/s
 Spritzbeutelauhfänger, Edelstahl
 Séchoir à poche, inox
 Secador cuelga-mangas, inox

art.	dim. cm.	h.
47107-00	50x42	26

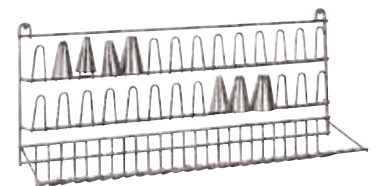

Espositore per bocchette, inox
 Wall rack for nozzles, s/s
 Tüllenaufhänger, Edelstahl Rostfrei
 Séchoir à douilles, inox
 Secador boquillas, inox

art.	dim. cm.	h.
47108-00	50x13	24



Siringa per pasticceria, set 20 pezzi
 Cookie press and icing set 20 pcs
 Gebäckspritze-Satz, 20 Stk.
 Pistolet pour pâtisserie, jeu 20 pcs
 Juego pistola repostería, juego 20 pcs.

art.	ml.
47010-20	250

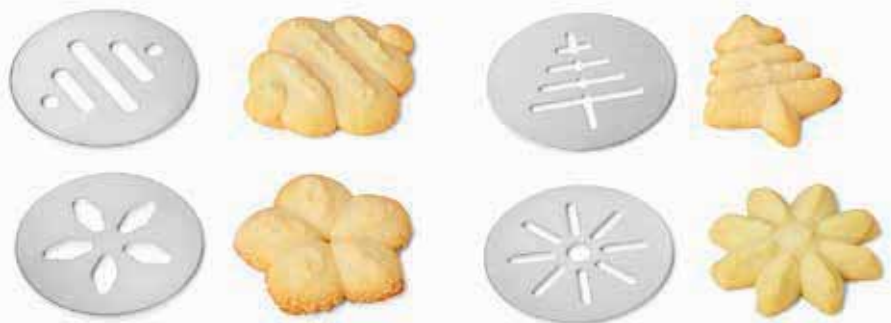

Per un utilizzo ottimale della siringa suggeriamo la frolla montata. Un composto soffice usato in pasticceria che si utilizza per la preparazione di tutti quei biscotti che per essere realizzati hanno bisogno di sac-à-poches oppure di sparabiscotti - **For a correct use of the syringe we suggest shortbread dough. This soft compound is used in pastry for the preparation of all those cookies made with pastry bags or biscuit maker.**



Vaso porta sacchetto, polipropilene
Icing bag holder, PP
Spritzbeutel-Absetzständer, PP
Support à poches, PP
Soporte para mangas, PP

art.	ø cm.	h.
47110-23	19,5	23



Girello per decorazione torte, melamina
Cake-plate, revolving disc, melamine
Tortendrehzscheibe, Melamin
Guéridon, plaque tournante, melamine
Pedestal giratorio para tartas, melamina

art.	ø cm.	h.
47103-32	32	10



Campana, PE
Protection cover, PE
Abdeckhauben, PE
Cloche, PE
Tapa, PE

art.	ø cm.	h.
47103-30	30	12



Girello, alluminio
Cake plate, swivel base, aluminum
Tortenplatte mit Drehfuß, aluminium
Guéridon plaque tournante, alu
Pedestal giratorio para tartas, aluminio

art.	ø cm.	h.
47101-30	30	10



Alzata torta, base girevole, alluminio
Cake plate, swivel base, aluminum
Tortenplatte mit Drehfuß, aluminium
Guéridon plaque tournante, alu
Pedestal giratorio para tartas, aluminio

art.	dim. cm.	h.
47101-40	30x40	10



Pala per torte, inox
Cake peel, s/s
Tortenschaufel, Edelstahl Rostfrei
Pelle à tarte, inox
Pala para tartas, inox

art.	ø cm.
47094-30	30



Pizzi sottotorta
Doilies
Tortenspitzen, Rosendekor
Dentelles décor rose
Blondas

art.	dim. cm.	u. pack
47687-24	18-25	250



Pizzi sottotorta
Doilies
Tortenspitzen, Rosendekor
Dentelles décor rose
Blondas

art.	ø cm.	u. pack
47686-10	6-10	250
47686-12	6,5-12	250
47686-14	8-14	250
47686-17	9,5-16,5	250
47686-22	12,5-22	100
47686-24	15-24	100



Pizzi sottotorta
Doilies
Tortenspitzen, Rosendekor
Dentelles décor rose
Blondas

art.	ø cm.	u. pack
47686-26	16-27	100
47686-30	19-30	100
47686-33	20-32	100
47686-36	22-36	100
47686-42	25-42	100

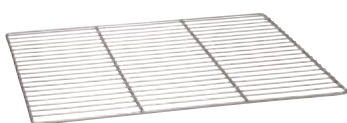

Griglia in filo, inox
Wire grid, s/s
Rost, Edelstahl Rostfrei
Grille, inox
Rejilla, inox

art.	dim. cm.
44430-60	60x40

quadro/frame ø 5 mm. - traverse/cross-bars 2 - fili/wires 29, ø 2 mm.

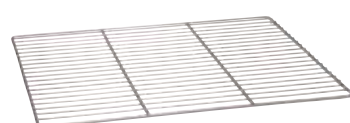

Griglia in filo, inox
Wire grid, s/s
Rost, Edelstahl Rostfrei
Grille, inox
Rejilla, inox

art.	dim. cm.
44430-61	60x40

quadro/frame ø 6 mm. - traverse/cross-bars 2 - fili/wires 24, ø 3 mm.



Griglia di colaggio, inox
Draining rack, s/s
überziehgitter, Edelstahl Rostfrei
Grille à glacier, inox
Rejilla, inox

art.	dim. cm.	h.
44431-46	46x30,5	2,5
44431-60	60x40	2,5



Teglia forata, alluminio
Perforated aluminum baking tray
Aluminium Backbleche, gelocht
Plaque à cuisson perforée, aluminium
Placa pastelería perforada, aluminio

art.	dim. cm.	h.	GN
41756-30	30x40	1	
41756-32	32,5x53	1	1/1
41756-53	53x65	1	2/1
41756-60	60x40	1	

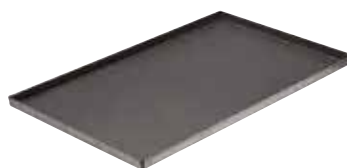

Teglia rettangolare, antiaderente
Baking sheet, non stick coated
Blech mit Antihftbeschichtung
Plaque avec revêtement anti-adhésif
Placa pastelería anti-adherente

art.	dim. cm.	h.
41747-60	60x40	2



Teglia rettangolare, alluminata
Baking sheet, alusteel
Blech mit Aluminiumüberzug
Plaque rectangulaire, tôle aluminitée
Placa pastelería, aluminio

art.	dim. cm.	h.
41746-60	60x40	2

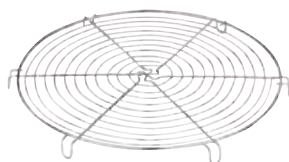

Griglia di raffreddamento, cromata
Cake cooling tray, chromed
Tortengitter, verchromt
Grille ronde à tourte, chromé
Rejilla para tortas, cromada

art.	Ø cm.
47098-18	18,5
47098-22	22,0
47098-26	26,0
47098-30	30,0

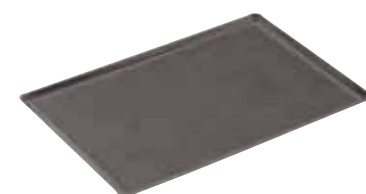

Teglia forata, siliconata
Perforated tray, silicone coated
Backbleche, gelocht, Silikonbeschichtet
Plaque perforée, revêtement silicone
Placa perforada anti-adherente

art.	dim. cm.	GN
41753-30	30x40	
41753-32	32,5x53	1/1
41753-53	53x65	2/1
41753-60	60x40	



Teglia , alluminio
Aluminum baking tray
Aluminium Backbleche
Plaque à cuisson, aluminium
Placa pastelería, aluminio

art.	dim. cm.	h.	GN
41744-32	32,5x53	1	1/1
41744-53	53x65	1	2/1
41744-60	60x40	1	



Teglia, siliconata
Tray, silicone coated
Backbleche, Silikonbeschichtet
Plaque, revêtement silicone
Placa anti-adherente siliconada

art.	dim. cm.	h.	GN
41743-32	32,5x53	1	1/1
41743-53	53x65	1	2/1
41743-60	60x40	1	



Teglia rettangolare, alluminata
Baking sheet, alusteel
Blech mit Aluminiumüberzug
Plaque, tôle aluminitée
Placa pastelería, aluminio

art.	dim. cm.	h.
41751-30	30x23	3
41751-35	35x28	3
41751-40	40x30	3
41751-50	50x35	3
41751-60	60x40	3
41751-65	65x45	3



Bacinella carré, ferro blu
Blue steel bread mold
Brotform, Blaublech
Pain de mie, tôle bleuie
Molde, hierro

art.	dim. cm.	h.
41748-20	20x10	10
41748-30	30x10	10
41748-35	35x10	10
41748-40	40x10	10
41748-50	50x10	10



Bacinella carré, alluminata
Bread mold, alusteel
Brotform mit Aluminiumüberzug
Pain de mie, tôle aluminitée
Molde, acero aluminizado

art.	dim. cm.	h.
41750-20	20x10	10
41750-30	30x10	10
41750-40	40x10	10
41750-41	40x15	15
41750-50	50x10	10



Dosa creme, inox
Cream dispenser, s/s
Dosierer, Edelstahl Rostfrei
Doseur à crème, inox
Dosificador, inox

art.	dim. cm.	h.	GN
47612-01	20x16	23	1/6



Imbuto colatore, inox
Confectionery funnel, stainless steel
Likör- u. Fondanttrichter, Edelstahl Rostfrei
Entonnoir à fondant, inox
Embudo colador, inox

art.	ø cm.	h.	lt.
47800-22	22	21	2

Con 3 bocchette ø 2, 4, 6 mm.
Supplied with 3 nozzles ø 2, 4, 6 mm.



Imbuto colatore, PC
Confectionery funnel
Likör- u. Fondanttrichter
Entonnoir à fondant
Embudo colador

art.	ø cm.	h.	lt.	°C
47801-20	14	20	0,9	-50° +120°

N



Dosatrice per creme, alluminio pressofuso
Cream injector, cast aluminum
Gebäckfüllmaschine
Entonnoir à crème
Dosificador de porciones

art.	dim. cm.	lt.
47694-03	44x25	3

Imbuto, cilindro, pistone, iniettore, leva e nasello di spinta in acciaio inox. Pistone: ø 24 mm. Dosi: 1-12 gr.
Funnel, cylinder, piston, injector, lever and thrust rib in s/s. Piston: ø 24 mm. Doses: 1-12 gr.



Caramellizzatore
Caramelising rod
Caramelisier-Eisen
Fer à caraméliser
Quemador

art.	ø cm.
47846-10	10,5



Caramellizzatore
Caramelizer
Caramelisier-Eisen
Carameliseur
Quemador eléctrico

art.	ø cm.	V	KW
47847-10	10	230	0,65
47847-12	12	230	1,00



Caramellizzatore
Caramelizer
Caramelisier-Eisen
Carameliseur
Quemador eléctrico

art.	l. cm.	V	KW
47847-23	23	230	1,5

Per qualsiasi tipo di prodotto da caramellare. Spolverare di zucchero semolato o zucchero a velo. Quando il caramellizzatore é incandescente, passare sul prodotto (creme, millefoglie, mousse, bavaresi, etc.). - For any product to be caramelized. Sprinkle with granulated sugar or icing sugar. When the caramelizer is white-hot pass it on the product (creams, puff pastries, mousses, Bavarians, etc.).

PASTICCERIA PASTRY UTENSILS
PREPARAZIONE PREPARATION TOOLS



Pistola elettrica
 Electric spray gun
 Sprühpistole, elektrisch
 Pistolet électrique
 Pistola eléctrica

art.	g./min	ml.	bar	Kg.
47848-07	280	700	0-160	1,1

Per burro, oli, cera, gelatina, marmellata, cioccolato, antiagglomeranti ed emulsionanti. Per liquidi caldi max. 65°C. Potenza 60 W. Bocchetta in dotazione da 0,6 mm. - For butter, oil, fat, wax, jelly, jam, chocolate, releasing agents and emulsions. Usable for hot liquids max. 65 °C. Power: 60 W. Equipped with nozzle 0,6 mm.



Temperatrice
 Tempering unit
 Temperierungsmaschine
 Tempereuse
 Unidad temperador



art.	dim. cm.	h.	vasca-basin dim. cm.	vasca-basin h.	lt.	V
47698-03	40x24	13,5	32,5x18	10	3,6	220
47698-06	40x33	13,5	32x26,5	10	6,0	220

Scioglitori a secco analogici, vasca in acciaio inox removibile, scocca e coperchio in plastica (PS). Termostato manuale. Su richiesta disponibili scioglitori con cablaggio GB / USA / GIAPPONE / AUSTRALIA / CINA. - Dry heat analogue melters, removable stainless steel tank with plastic lid and housing. Manual thermostat. UK / US / JAPAN / AUSTRALIA / CHINA wirings available upon request.



Compressore per penna aerografa
 Airbrush compressor
 Airbrush Kompressor
 Compresseur
 Compresor

art.	cap.	dim. cm	V	W
47844-06	4 bar	16x30x23	230	200



Penna aerografa, doppia azione
 Airbrush, double action
 Airbrush-Pistole, doppelt
 Aérographe, dual action
 Equipo aerógrafo, doble acción

art.	cap.	foro/nozzle
47844-02	7 cm ³	0,3 mm
47844-01	supporto/stand/Gestell	



Cannello professionale
 Chef's torch
 Profi-Wärmepistole
 Chalumeau de cuisine
 Soplete cocina

art.	dim. cm.	ml.	gr.
47841-04	12x7x18	280	420



Cannello professionale
 Chef's torch
 Profi-Wärmepistole
 Chalumeau de cuisine
 Soplete cocina

art.	dim. cm.	ml.	gr.
47841-03	8x7x16	200	220



Pompetta con terminale in rame
Sugar bulb
Blaszuckerspritze
Poire à sucre soufflé
Pera para azúcar soplado

art.
47838-00



Termometro per zucchero, inox
Sugar thermometer, stainless steel
Zuckerthermometer, Edelstahl Rostfrei
Thermomètre à sucre, inox
Termometro para azúcar, inox

art.	scala	range
47843-00	1°C	+80+200°C



Reggi caramellometro
Sugar thermometer holder
Zuckerthermometer-Träger
Support pour thermomètre à sucre
Soporte para termometro azúcar

art.	h. cm.
47842-00	32



Provetta alimentare graduata, plastica
Syrup density meter test tube
Sirup-Hydrometer-Becher
Eprouvette pèse-sirop
Probeta aerómetro

art.	ø cm.	h.	ml.
49703-01	3	25	100

Sterilizzabile fino a 120°C. - Graduated, plastic, can be sterilized up to 120°C.



Pesa sciropo (densimetro)
Syrup density meter
Sirup-Hydrometer
Pèse-sirop
Aerómetro

art.	l. cm.	gr./ml./°Bé
49703-00	12,5	1.100/1.400/15-40

Temp.: 20°C
Div.: 0,010 g/ml/2°Bé



Spatola angolare
Angular spatula
Winkelpalette
Spatule angulaire
Espátula

art.	l. cm.
12909-12	12
12909-23	23



Stendipasta, ABS
Smoother
Teig-Glätter
Lisser-pâte
Espátula para alisar

art.	dim. cm.
47627-01	16x8



Spatola per biscuit
Biscuit spatula
Biscuit-Spachtel
Spatule à biscuit
Espátula para biscuit

art.	l. cm.
47626-55	55,5



Riga
Ruler
Lineal
Règle
Regla

art.	l. cm.
47033-50	60

Con 5 divisioni da 12 cm e 7 da 8 cm.
5 divisions of cm 12 - 7 divisions of cm 8.

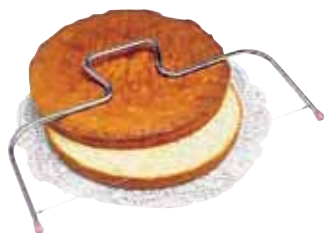

Lira per pan di Spagna
Cake slicer
Tortendrahtschneider
Lyre à genoise
Cortador de pasteles

art.	ø cm.	h. mm.
47031-44	30	20→60

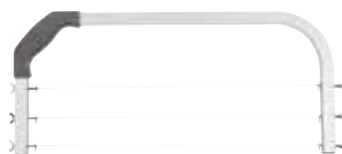

Lira per pan di Spagna, 3 fili
Cake slicer, 3 cutting wires
Tortendrahtschneider, 3
Lyre à genoise, 3 lames
Cortador de pasteles, 3

art.	ø cm.	h. mm.
47031-46	46	10→90





Chitarra mini
Mini guitar
Praliné-Schneideapparat
Appareil à couper les pralinés
Cortador para pasteles

art. dim. cm.
47692-03 24x24



Mini chitarra per ganache con base in plastica dimensione utile 24x24 cm e telai in acciaio. Include un telaio da 22 mm, un piatto in acciaio, una spatola in plastica ed alcuni accessori per la manutenzione. Adatta a piccole produzioni è ideale per scuole, ristoranti, gelaterie, piccole cioccolaterie. Può essere facilmente posizionata in piccoli spazi e utilizzata solo all'occorrenza. Non usare per torte congelate, tavolette di cioccolata, impasti duri in genere.

Mini guitar for ganaches with plastic base usable size 24x24 cm and steel frames. Includes a frame of 22 mm, a steel plate, a plastic spatula and some accessories for maintenance. Suitable for small-scale production, is ideal for schools, restaurants, pubs, small chocolate shops. It can be easily placed in small spaces and used only where appropriate. Do not use for frozen pies, chocolate bars or generally hard paste.



Base per ganache + 4 telai
Base for ganache and 4 frames
Basis und 4 Rahmen für Ganache
Base et 4 cadres à ganache
Base y 4 cuadros para ganache

art. dim. cm. h.
47693-00 39x45 13

Il kit per la produzione di ganaches include 2 telai da 3 mm, 2 telai da 5 mm, una spatola e la base in teflon. Misura ganache 24x24 cm. - The kit includes 2 frames of 3 mm, 2 frames of 5 mm, a spatula and the Teflon base. Ganache's size 24x24 cm.



Quadri per ganache, inox
Frames, stainless steel
Rahmen, Edelstahl Rostfrei
Cadres, inox
Cuadros, inox

art.	dim. cm.	h.	int. dim. cm
47693-03	40x40	0,3	36x36
47693-05	40x40	0,5	36x36
47693-10	40x40	1,0	36x36
47693-15	40x40	1,5	36x36



Chitarra
Guitar
Praliné-Schneideapparat
Appareil à couper les pralinés
Cortador para pasteles

art. dim. cm. h.
47692-01 39x45 13

Chitarra a taglio semplice. Ideale per tagliare in precise porzioni gli impasti morbidi come la crema ganache, il pan di Spagna e il cioccolato fuso. Base in PST, 4 telai inox da 22,5 - 30 e 45 mm. Inclusi 1 piatto inox, racla in PST, 3 fili di ricambio, 2 chiavi per fissaggio dei fili. - Single guitar ideal for cut in precise portions dough as soft as the ganache cream, sponge cake and chocolate melted. PST plastic base, 3 stainless steel cutting frames of 22,5 - 30 and 45 mm. Including 1 s/s sheet, plastic spatula, 3 spare wires, 2 wires fixing spanners.



Chitarra doppia
Double guitar
Praliné-Schneideapparat
Appareil à couper les pralinés
Cortador para pasteles

art. dim. cm. h.
47692-02 39x45 13

Chitarra a doppio taglio. Ideale per tagliare in porzioni nette cremieri, semifreddi ed altri prodotti dolciari con composti morbidi. Base in PST, 4 telai inox da 22,5 - 30 - 45 e laterale fisso da 30 mm. Inclusi 1 piatto inox, racla in PST, 3 fili di ricambio, 2 chiavi per fissaggio dei fili. - Double guitar. Ideal for cutting sweet products with soft compounds. PST base, 4 stainless steel cutting frames of 22,5 - 30 - 45 mm. and fixed side cutting frame 30 mm. Including 1 s/s sheet, plastic spatula, 3 spare wires, 2 wires fixing spanners.

PASTICCERIA PASTRY UTENSILS



Tagliapasta estensibile, inox
Expanding pastry cutter, s/s
Teigschneider, Edelstahl Rostfrei
Rouleau extensible, inox
Cortapastas extensible, inox

art.	Ø cm.	l.
47820-05	5,5	24
47820-07	5,5	24



Tagliapasta estensibile, inox
Expanding pastry cutter, s/s
Teigschneider, Edelstahl Rostfrei
Rouleau extensible, inox
Cortapastas extensible, inox

art.	Ø cm.	l.
47821-05	5,5	24
47821-07	5,5	24



Tagliapasta estensibile, inox
Expanding pastry cutter, s/s
Teigschneider, Edelstahl Rostfrei
Rouleau extensible, inox
Cortapastas extensible, inox

art.	Ø cm.	l.
47822-05	5,5	28
47822-07	5,5	28

Strisce da 10 a 125 mm. - For pastry stripes 10-125 mm wide.



Tagliapasta estensibile, inox
Expanding pastry cutter, s/s
Teigschneider, Edelstahl Rostfrei
Rouleau extensible, inox
Cortapastas extensible, inox

art.	Ø cm.
47830-05	9,5
47830-07	9,5

Strisce da 10 a 125 mm.
For pastry stripes 10-125 mm wide.



Rotella taglia pasta liscia, inox
Pastry wheel, plain, stainless steel
Teigrädchen, glatt, Edelstahl Rostfrei
Roulette à pâte lisse, inox
Ruleta cortapasta, inox

art.	Ø cm.	l.
18325-01	5,5	18



Rotella taglia pasta ondulata, inox
Pastry wheel, fluted, stainless steel
Teigrädchen, gewellt, Edelstahl Rostfrei
Roulette à pâte cannelée, inox
Ruleta cortapasta acanalada, inox

art.	Ø cm.	l.
18325-02	5,5	18



Rotella taglia pasta lama doppia, inox
Double pastry wheel, stainless steel
Teigrädchen, glatt u. gewellt, Edelstahl
Roulette à pâte double, inox
Ruleta cortapasta doble, inox

art.	Ø cm.	l.
18325-03	5,5	18

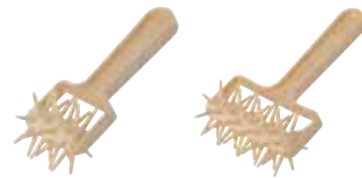

Rullo bucasfoglia, POM
Spiked roller, POM
Stipprolle, POM
Pique-pâte, POM
Rodillo, POM

art.	l. cm.
47024-06	6,0
47024-10	11,5



Rullo per losanghe, POM
Cutting roller, POM
Rollmesser, POM
Rouleau à losanges, POM
Rodillo a rombos, POM

art.	l. cm.
47025-06	6,0
47025-10	11,5



Rullo tagliapasta, POM
Cutting roller, POM
Rollmesser, POM
Rouleau à lamelles, POM
Rodillo, POM

art.	l. cm.
47026-06	6,0



Rullo bucasfoglia, inox
Spiked roller, stainless steel
Stipprolle, Edelstahl Rostfrei
Pique-pâte, inox
Rodillo, inox

art.	l. cm.
47028-12	12



Rullo per losanghe, inox
Cutting roller, stainless steel
Rollmesser, Edelstahl Rostfrei
Rouleau à losanges, inox
Rodillo a rombos, inox

art.	l. cm.
47029-12	12

PASTICCERIA PASTRY UTENSILS
PREPARAZIONE PREPARATION TOOLS



Taglia croissants, inox
 Croissant cutter, stainless steel
 Dreieckschneidewalze, Edelstahl
 Coupe-croissants, inox
 Cortador para croissants, inox

art.	dim. cm.	
47027-11	18x20	
47027-12	18x14	
47027-13	11x15	
47027-14	9,7x21	
47027-15	18x20	2x
47027-16	18x20	3x

Manici in polipropilene.
 Polypropylene handles.



Stampo decora crostate, PS
 Stencil for grating pastry, PS
 Gitterstempel, PS
 Empreinte pour grille de pâte, PS
 Molde tortas, PS

art.	Ø cm.
47030-30	30

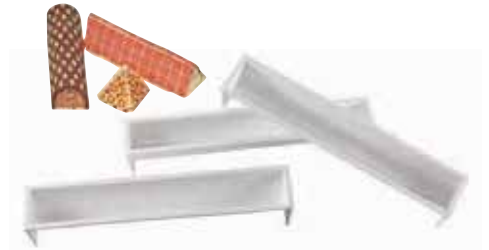

Stampo per tronco, plastica
 Log mold, plastic
 Kastenform, Kunststoff
 Gouttière, plastique
 Molde, plástico

art.	Ø cm.	h.	
47659-01	48x6,5	7	
47659-02	48x6,5	7	
47659-03	48x6,5	7	
47659-04	48x5,0	4	

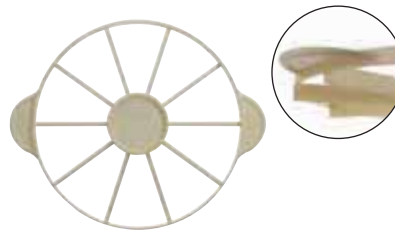

Segnaporzioni per torte, PP
 Cake marker, PP
 Tortenteiler, PP
 Diviseur à tarte, double, PP
 Marcador de tartas, PP

art.	Ø cm.	pz/pcs
47032-10	26,5	10
47032-20	26,5	20



Segnaporzioni per torte, doppio, PP
 Cake marker, double-sided, PP
 Tortenteiler, doppelseitig, PP
 Diviseur à tarte, double, PP
 Marcador de tartas, doble, PP

art.	Ø cm.	pz/pcs
47033-08	18,0	8-12
47033-12	26,5	12-18
47033-14	26,5	14-18



Rullo antiaderente
 Rolling pin, non-stick coated
 Rollwalze mit Antihftbeschichtung
 Rouleau avec revêtement anti-adhésif
 Rodillo amasador anti-adherente

art.	Ø cm.	l.
47035-40	5,5	20
47035-48	6,5	25



Rullo in legno
 Wooden rolling pin
 Rollhölzer
 Rouleau en bois
 Rodillo amasador, madera

art.	Ø cm.	l.
47036-30	9	30
47036-35	9	35
47036-40	9	40
47036-45	9	45
47036-50	9	50
47036-60	9	60



Rullo in legno
 Wooden rolling pin
 Rollhölzer
 Rouleau en bois
 Rodillo amasador, madera

art.	Ø cm.	l.
47038-50	9	50
47038-60	7	60

PASTICCERIA PASTRY UTENSILS



Rullo in polietilene
Rolling pin, PE
Rollwalze, PE
Rouleau, PE
Rodillo amasador, PE

art.	Ø cm.	l.	kg.
47037-30	8,0	30	1,7
47037-40	7,5	40	2,2



Rullo tagliapasta, PE
Rolling dough cutter, PE
Rollholzer, PE
Rouleau coupe-bandes, PE
Rodillo cortador, PE

art.	l. cm.	taglio/cut mm.
47039-05	19	5
47039-10	19	10



Rullo tagliapasta, PE
Rolling dough cutter, PE
Rollholzer, PE
Rouleau coupe-bandes, PE
Rodillo cortador, PE

art.	l. cm.	taglio/cut mm.
47039-15	19	15



Rullo, PE
Rolling pin, PE
Rollwalze, PE
Rouleau, PE
Rodillo amasador, PE

art.	Ø cm.	l.
47034-23	2,5	23
47034-51	5,0	50



Rullo in legno
Wooden rolling pin
Rollhölzer
Rouleau en bois
Rodillo amasador, madera

art.	Ø cm.	l.
47034-52	5	50



Rullo, inox
Rolling pin, stainless steel
Rollwalze, Edelstahl Rostfrei
Rouleau, inox
Rodillo amasador, inox

art.	Ø cm.	l.
47034-50	5	50



N

Pennello setole antiaderenti
Pastry brush non-stick coated bristles
Pinsel, antihafbeschichtete Borste
Pinceau poils anti-adhérentes
Pincel cerdas antiadherentes

art.	l. cm.	u. pack
47640-25	2,5	1
47640-35	3,5	1

Setole rosse antiaderenti in nylon.
Resistente al calore fino a +150°C.
Non-stick coated red bristles made of nylon. Heat resistant up to +150°C.



Pennello per alimenti
Pastry brush
Kuchenpinsel
Pinceaux à pâtissier
Pincel

art.	l. cm.	u. pack
47642-30	3	6
47642-40	4	6
47642-50	5	6
47642-60	6	6
47642-70	7	6

Manico plastica, ghiera inox. - Plastic handle, stainless steel ferrule.



Pennello per alimenti
Pastry brush
Kuchenpinsel
Pinceaux à pâtissier
Pincel

art.	l. cm.	u. pack
47643-30	3	6
47643-40	4	6
47643-50	5	6
47643-60	6	6
47643-70	7	6



Pennello per alimenti
Pastry brush
Kuchenpinsel
Pinceaux à pâtissier
Pincel

art.	Ø cm.	u. pack
47644-15	1,5	6

Manico e ghiera plastica.
Plastic handle and ferrule.



Pennello per alimenti, PA
Pastry brush, PA
Kuchenpinsel, PA
Pinceaux à pâtissier, PA
Pincel, PA

art.	l. cm.	u. pack
47645-40	4,0	6
47645-60	6,0	6
47645-75	7,5	6

Setole naturali. - Natural bristles.



Pennello per alimenti, PA
Pastry brush, PA
Kuchenpinsel, PA
Pinceaux à pâtissier, PA
Pincel, PA

art.	l. cm.	u. pack
47646-40	4,0	6
47646-60	6,0	6
47646-75	7,5	6

Setole in poliestere. - Polyester bristles.



Raschietti, PP
Dough scrapers, PP
Teigschaber, PP
Raclettes, PP
Rasquetas, PP

art. dim. mm. u.pack
47621-01 216x128 10



Raschietti, PP
Dough scrapers, PP
Teigschaber, PP
Raclettes, PP
Rasquetas, PP

art. dim. mm. u.pack
47621-02 120x86 10



Raschietti, PP
Dough scrapers, PP
Teigschaber, PP
Raclettes, PP
Rasquetas, PP

art. dim. mm. u.pack
47621-03 120x88 10



Raschietti, PP
Dough scrapers, PP
Teigschaber, PP
Raclettes, PP
Rasquetas, PP

art. dim. mm. u.pack
47621-04 121x81 10



Raschietti, PP
Dough scrapers, PP
Teigschaber, PP
Raclettes, PP
Rasquetas, PP

art. dim. mm. u.pack
47621-05 148x99 10



Pettine decoratore, PP
Decorating comb, PP
Dekorationskamm, PP
Peigne à decor, PP
Peine decorador, PP

art. dim. mm. u.pack
47621-06 145x99 10



Pettine decoratore, PP
Decorating comb, PP
Dekorationskamm, PP
Peigne à decor, PP
Peine decorador, PP

art. dim. mm. u.pack
47621-07 110x80 10



Pettine decoratore, PP
Decorating comb, PP
Dekorationskamm, PP
Peigne à decor, PP
Peine decorador, PP

art. dim. mm. u.pack
47621-08 216x128 10



Set 3 pettini decoratori, inox
Set 3 decorating combs, stainless steel
Dekorationskamm, 3 Stk, Edelstahl
Set 3 peignes à decor, inox
Conjunto 3 peines decoradores, inox

art. dim. cm.
47625-03 10x10



Spargi zucchero, inox
Sugar dredger, stainless steel
Zuckerstreuer, Edelstahl Rostfrei
Glacière à sucre, inox
Dosificador para azúcar, inox

art. Ø cm. h.
47022-12 7 12



Bottiglia per bagne
Bottle for rum spraying
Flasche zum Anfeuchten
Bouteille à puncher
Botella para bañar

art. lt. cm. h.
47679-10 1 10x5,6 27,5



Setaccio farina, inox
Flour sifter, stainless steel
Einhand-Drücksied, Edelstahl Rostfrei
Tamiseur farine, inox
Cedazos, inox

art. Ø cm. h. gr.
42607-05 12 13 500



Setaccio per zucchero a velo
Icing sugar sieve
Sieb für Puderzucker
Tamis à sucre glace
Cedazos

art. Ø cm. h.
47614-25 25,5 7



Setaccio rete farina
Sieve for flour
Sieb für Mehl
Tamis pour farine
Cedazos

art. Ø cm. h.
47615-25 25,5 7



Spazzola per farina
Flour brush
Mehlbürste
Brosse à pétrin
Cepillo para harina

art. l.cm.
42614-21 30
Setole di cavallo. - Horse hair.

P

PASTICCERIA PASTRY UTENSILS



Vassoio pasticceria, inox
Pastry tray, stainless steel
Auslegeplatte, Edelstahl Rostfrei
Plat patissier, inox
Bandeja pastelería, inox

art.	dim. cm.	h.
47075-20	20x16	1
47075-30	30x21	1
47075-45	45x34	1



Vassoio vetrina, alluminio
Display plate, aluminum
Auslegeplatte, Aluminium
Plateau pour présentation, alu
Bandeja pastelería, aluminio

art.	dim. cm.	h.
47070-37	37,5x24,5	1
47070-48	48x31	1
47070-60	60x40	1



Vassoio espositore, inox
Tray, stainless steel
Auslegeplatte, Edelstahl Rostfrei
Plateau, inox
Bandeja pastelería, inox

art.	dim. cm.	h.
42533-23	23x16,5	0,5
42533-26	26x19,5	0,5
42533-31	31x24	0,5
42533-36	36x28,5	0,5
42533-40	40x32,5	0,5



Carta da forno siliconata
Baking paper, siliconized
Baktrennfolie, silikonisiert
Feuille de cuisson, siliconée
Papel de horno siliconado

art.	dim. cm.	GN	u.pack
47682-53	53x32,5	1/1	500
47682-60	60x40		500

Pergamena artificiale, sbiancata, g/m²: 41,0, siliconata fronte/retro, riutilizzabile, idonea per tutti i tipi di pasta. - Artificial parchment, bleached, g/m²: 41,0, both sides siliconized, reusable, for all kinds of dough.



Carta da forno, rivestimento PTFE
Baking paper, PTFE coated
Baktrennfolie, PTFE-beschichtet
Feuille de cuisson, revêtement PTFE
Papel de horno anti-adherente

art.	dim. cm.	u. pack
47681-60	60x40	10

Tessuto in fibra di vetro rivestito in PTFE, resistente alla trazione, antiaderente, riutilizzabile più di 500 volte. Asciugare dopo l'uso. - PTFE coated tissue on both sides, can be used up to 500 times, tear-proof. Carefully dry after use.

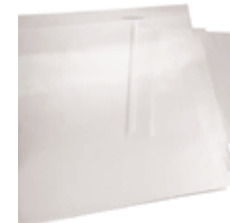

Acetato in fogli
Acetate sheets
Acetat Band-Blätter
Feuilles en acétate
Hojas de acetato

art.	my	dim. cm.	u.pack
47131-30	90	30x30	50
47131-60	90	60x40	50



N

Tappeto silicone microforato
Silicone baking sheet, microperforated
Silikonbackmatte, microperforiert
Tapis cuisson en silicone, microperforé
Tapete de cocción silicona, microperforado

art.	dim. cm.
47691-53	52x31,5
47691-64	58,5x38,5



Tappeto silicone
Silicone baking sheet
Silikonbackmatte
Tapis cuisson en silicone
Tapete de cocción silicona

art.	dim. cm.	GN
47689-53	53x32,5	1/1
47689-60	60x40	



Nastro PVC
PVC ribbon
PVC Band
Ruban pâtissier en PVC
Cinta PVC

art.	h. mm	my	mt.
47130-25	25	90	305
47130-30	30	90	305
47130-35	35	90	305
47130-40	40	90	305
47130-45	45	90	305
47130-50	50	90	305
47130-55	55	90	305
47130-60	60	90	305



Noccioli di cottura in ceramica
Baking beans, ceramic
Backkerne, Keramik
Noyaux de cuisson, céramique
Núcleos de cocción, cerámica

art. kg.
47011-01 1



Supporto antiaderente areato ideale per la cottura di pani e per la cottura in bianco di fondi per crostate.
Non-stick perforated sheet ideal for baking bread and tarts.



Grazie al rivestimento in silicone su entrambi i lati, il supporto Roul'pat non scivola sul piano di lavoro. Permette di lavorare ogni tipo di pasta, ma anche di lavorare con grande facilità il croccante.
The silicone coating on both sides prevents the sheet from slipping. Perfect to prepare any type of dough and it also enables to easily prepare macaroon.



Tappeto silicone **SILPAT**
Silicone baking sheet
Silikonbackmatte
Tapis de cuisson en silicone
Tapete de cocción silicóna

art.	dim. cm.	GN
47680-40	40x30	
47680-53	53x32,5	1/1
47680-60	60x40	



Tappeto silicone **SILPAIN**
Silicone baking sheet
Silikonbackmatte
Tapis de cuisson en silicone
Tapete de cocción silicóna

art.	dim. cm.	GN
47685-53	53x32,5	1/1
47685-60	60x40	



Tappeto silicone **ROUL'PAT**
Silicone baking sheet
Silikonbackmatte
Tapis de cuisson en silicone
Tapete de cocción silicóna

art.	dim. cm.
47688-60	60x40



Anello per torte, inox
Tart ring, stainless steel
Tortenring, Edelstahl Rostfrei
Cercle à tarte, inox
Anillo para tartas, inox

art.	Ø cm.	h.
47533-07	7	2
47533-08	8	2
47533-09	9	2
47533-10	10	2
47533-12	12	2
47533-14	14	2
47533-16	16	2
47533-18	18	2
47533-20	20	2
47533-22	22	2
47533-24	24	2
47533-26	26	2
47533-28	28	2
47533-30	30	2
47533-32	32	2



Anello per torte, inox
Pudding ring, stainless steel
Tortenringe, Edelstahl Rostfrei
Cercle à entremet, inox
Anillo para postres caseros, inox

art.	Ø cm.	h. cm.
47530-14	14	3,5
47530-16	16	3,5
47530-18	18	3,5
47530-20	20	3,5
47530-22	22	3,5
47530-24	24	3,5
47530-26	26	3,5
47530-28	28	3,5
47530-30	30	3,5



Anello per mousse, inox
Mousse ring, stainless steel
Schaumspesenring, Edelstahl Rostfrei
Cercle à mousse, inox
Anillo para mousse, inox

art.	Ø cm.	h.
47532-06	6,0	4,0
47532-07	7,5	4,0
47532-08	8,0	4,5
47532-12	12,0	4,5
47532-14	14,0	4,5
47532-16	16,0	4,5
47532-18	18,0	4,5
47532-20	20,0	4,5
47532-22	22,0	4,5
47532-24	24,0	4,5
47532-26	26,0	4,5



Anello per torte gelato, inox
Ice cream cake ring, s/s
Eistortenring, Edelstahl Rostfrei
Cercle à vacherin, inox
Circulo alto, inox

art.	Ø cm.	h.
47534-07	7	9
47534-08	9	9
47534-09	7	11
47534-10	9	11



Anello per torte gelato, inox
Ice cream cake ring, s/s
Eistortenring, Edelstahl Rostfrei
Cercle à vacherin, inox
Anillo para helados, inox

art.	Ø cm.	h.
47534-06	6	6
47534-16	16	6
47534-18	18	6
47534-20	20	6
47534-22	22	6
47534-24	24	6
47534-26	26	6
47534-28	28	6



Anello regolabile, inox flessibile
Cake setting ring, flexible s/s
Tortenring, verstellbar, flexiblem E. R.
Cercle à tarte, réglable, inox flexible
Anillo ajustable, inox flexible

art.	Ø min. cm.	Ø max. cm.	h.
47529-07	16,5	32	7



Quadro, inox
Cake ring, stainless steel
Tortenform, Edelstahl Rostfrei
Cadre à tarte, inox
Marco para tarta, inox

art.	dim. cm.	h.
47527-55	55x35,5	4,5



Telaio regolabile, inox
Extensible frame, stainless steel
Backrahm, verstellbar, Edelstahl
Bande à tarte réglable, inox
Marco para tarta, ajustable, inox

art.	dim. min. cm.	dim. max. cm.	h.
47526-05	30x30	57x56	5



Telaio regolabile, inox flessibile
Rectangular cake setting ring, flexible s/s
Backform, verstellbar, flexiblem E. R.
Marco à tarte, réglable, inox flexible
Banda para tarta, ajustable, inox flexible

art.	dim. min. cm.	dim. max. cm.	h.
47528-05	19x28	34x54	5



Rettangolo, inox
Rectangle, stainless steel
Rechteck, Edelstahl Rostfrei
Rectangle, inox
Rectangular, inox

art.	dim. cm.	h.
47546-18	18x36	5
47546-30	30x40	5
47546-40	40x60	5



Quadrato, inox
Square, stainless steel
Quadrat, Edelstahl Rostfrei
Carré, inox
Cuadrado, inox

art.	dim. cm.	h.
47548-02	10x10	4,5
47548-03	18x18	4,5
47548-04	20x20	4,5
47548-05	22x22	4,5



Quadrato, inox
Square, stainless steel
Viereck, Edelstahl Rostfrei
Carré, inox
Cuadrado abombado, inox

art.	dim. cm.	h.
47541-02	10x10	4,5
47541-03	18x18	4,5
47541-04	20x20	4,5



Ovale, inox
Oval, stainless steel
Oval, Edelstahl Rostfrei
Ovale, inox
Oval, inox

art.	Ø cm.	h.
47547-22	22	4
47547-26	26	4
47547-30	30	4



Virgola, inox
Comma, stainless steel
Komma, Edelstahl Rostfrei
Virgule, inox
Coma, inox

art.	Ø cm.	h.
47544-20	20	4
47544-25	25	4
47544-30	30	4



Cuore, inox
Heart, stainless steel
Herz, Edelstahl Rostfrei
Coeur, inox
Corazón, inox

art.	Ø cm.	h.
47542-18	18	4
47542-20	20	4
47542-22	22	4
47542-24	24	4
47542-26	26	4



Triangolo, inox
Triangle, stainless steel
Dreieck, Edelstahl Rostfrei
Triangle, inox
Triángulo, inox

art.	Ø cm.	h.
47540-02	12	4,5
47540-03	20	4,5
47540-04	22	4,5
47540-05	24	4,5



Triangolo, inox
Triangle, stainless steel
Dreieck, Edelstahl Rostfrei
Triangle, inox
Triángulo, inox

art.	Ø cm.	h.
47538-20	20	4
47538-23	23	4
47538-26	26	4



Fascia, inox
Cake ring, stainless steel
Tortenring, Edelstahl Rostfrei
Cercle, inox
Anillo tarta, inox

art.	dim. cm.	h.
47546-21	25x9	2
47546-22	30x9,1	2
47546-23	35x9,2	2
47546-41	25x9	4
47546-42	30x9,1	4
47546-43	35x9,2	4
47546-51	25x9	5
47546-52	30x9,1	5
47546-53	35x9,2	5

N



Piramide, inox
Pyramid, stainless steel
Pyramide, Edelstahl Rostfrei
Piramide, inox
Pirámide, inox

art.	Ø cm.	h.
47535-09	9	06
47535-12	12	08
47535-15	15	10
47535-17	17	12
47535-19	19	13



Semi-sfera, inox
Half sphere, stainless steel
Halbkugel, Edelstahl Rostfrei
Demi-sphère, inox
Semiesfera, inox

art.	Ø cm.	h.
47536-12	12	6
47536-14	14	7
47536-16	16	8
47536-18	18	9
47536-20	20	10



Crème caramel, inox
Crème caramel, stainless steel
Crème caramel, Edelstahl rostfrei
Crème caramel, inox
Molde para flan, inox

art.	Ø cm.	h.	ml.
41660-10	7	5	150
41660-15	7	6	180



Fascia microforata, inox
Microperforated cake ring, stainless steel
Tortenring mikroperforiert, Edelstahl Rostfrei
Cercle microperforé, inox
Anillo tarta microperforado, inox

art.	ø cm.	h.
47510-15	15	3,5
47510-17	17	3,5
47510-19	19	3,5
47510-21	21	3,5
47510-23	23	3,5

Fascia microforata, inox
Microperforated cake ring, stainless steel
Tortenring mikroperforiert, Edelstahl Rostfrei
Cercle microperforé, inox
Anillo tarta microperforado, inox

art.	ø cm.	h.
47511-07	7	2
47511-09	9	2
47511-11	11	2
47511-15	15	2
47511-17	17	2
47511-19	19	2
47511-21	21	2
47511-23	23	2
47511-25	25	2

Fascia microforata, inox
Microperforated cake ring, stainless steel
Tortenring mikroperforiert, Edelstahl Rostfrei
Cercle microperforé, inox
Anillo tarta microperforado, inox

art.	dim. cm.	h.
47512-15	15x15	3,5
47512-19	19x19	3,5



Fascia microforata, inox
Microperforated cake ring, stainless steel
Tortenring mikroperforiert, Edelstahl Rostfrei
Cercle microperforé, inox
Anillo tarta microperforado, inox

art.	dim. cm.	h.
47513-06	6,5x6,5	2
47513-08	8,5x8,5	2
47513-10	10,5x10,5	2
47513-15	15x15	2
47513-19	19x19	2

Fascia microforata, inox
Microperforated cake ring, stainless steel
Tortenring mikroperforiert, Edelstahl Rostfrei
Cercle microperforé, inox
Anillo tarta microperforado, inox

art.	dim. cm.	h.
47514-19	19x8	3,5
47514-29	29x9	3,5

Fascia microforata, inox
Microperforated cake ring, stainless steel
Tortenring mikroperforiert, Edelstahl Rostfrei
Cercle microperforé, inox
Anillo tarta microperforado, inox

art.	dim. cm.	h.
47515-19	19x8	2
47515-29	29x9	2



Tortiera, alluminio
Piepan, aluminum
Tortenform, Aluminium
Tourtière, alu
Molde, aluminio

art.	Ø cm.	h.
16940-28	28	5,0
16940-32	32	5,5
16940-36	36	6,0
16940-40	40	6,5



Ciambella, alluminio
Savarin tin, aluminum
Savarinform, Aluminium
Moule à savarin, alu
Molde para savarin, aluminio

art.	Ø cm.	h.	u.pack
47060-06	6,0	2,5	3
47060-07	7,5	3,0	3
47060-09	9,0	3,5	3
47060-10	10,0	3,5	3
47060-12	12,0	5,5	3
47060-14	14,0	5,5	3
47060-16	16,0	5,5	3
47060-18	18,0	6,5	3
47060-20	20,0	6,5	3
47060-22	22,0	6,5	3
47060-24	24,0	8,5	3
47060-26	26,0	8,5	3
47060-30	30,0	8,5	3



Stampo pandoro, alluminio
Pandoro mold, aluminum
Pandoro-Form, Aluminium
Moule à pandoro, aluminium
Molde pandoro, aluminio

art.	gr.
47063-01	100
47063-02	250
47063-05	500
47063-07	750
47063-10	1000

N



Stampo americano, alluminio
Gugelhupf, aluminum
Gugelhupfform, Aluminium
Moule à gugelhupf, alu
Molde gugelhupf, aluminio

art.	Ø cm.	h.
47062-18	18	10,5
47062-20	20	11,0
47062-22	22	12,0



Plumcake, alluminio
Plumcake, aluminum
Plumcake, Aluminium
Plumcake, alu
Molde para plumcake, aluminio

art.	dim. cm.	h.
47064-18	18x80	6
47064-22	22x90	7
47064-26	26x10	8
47064-30	30x11	9



Stampo per babà, alluminio
Beaker shaped tin, aluminum
Timbalform, Aluminium
Moule à dariole, alu
Molde, aluminio

art.	Ø cm.	h.	u.pack
47066-03	3	3,5	10
47066-04	4	4,5	10
47066-05	5	5,5	10
47066-06	6	6,0	10
47066-07	7	7,0	10
47066-08	8	8,0	10



Crème caramel, alluminio
Crème caramel, aluminum
Crème caramel, Aluminium
Crème caramel, alu
Molde para crème caramel, aluminio

art.	Ø cm.	h.	u.pack
41659-06	6	4,8	6
41659-07	7	5,0	6
41659-08	8	5,3	6



Stampo cassata, alluminio
Cassata mold, aluminum
Cassataform, Aluminium
Moule à cassata, alu
Molde para cassata, aluminio

art.	dim. cm.	h.
47068-12	12	10
47068-15	15	12



Stampo per zuccotto, alluminio
Zuccotto mold, aluminum
Zuccottoform, Aluminium
Moule à zuccotto, alu
Molde para zuccotto, aluminio

art.	Ø cm.
47069-10	10
47069-12	12
47069-14	14
47069-16	16
47069-18	18
47069-20	20

TORTIERE ANTIADERENTI *NON STICK CAKE MOLDS*



PASTICCERIA PASTRY UTENSILS
TORTIERE ANTIADERENTI NON STICK CAKE MOLDS



Tortiera pino
Pine mold
Tannenbaumform
Tourtière pin
Molde pino

art.	dim. cm.	h.
47005-24	17x24	8,5



Tortiera stella
Star, mold
Sternform
Tourtière étoile
Molde estrella

art.	dim. cm.	h.
47006-25	25x25	4,5



Tortiera festonata
Round mold, fluted edges
Runde Obsttortenform
Tourtière ronde bord cannelé
Molde rizado

art.	Ø cm.	h.
47709-20	20	2,5
47709-24	24	2,5
47709-28	28	2,5
47709-32	32	2,5



Tortiera forata
Crispy tart pan
Tortenform, gelocht
Tourtière perforée
Molde perforado

art.	Ø cm.	h.
41729-30	30	1,3
41729-34	34	1,3



Tortiera tonda
Round cake tin
Tortenform, rund
Manqué rond uni
Molde redondo

art.	Ø cm.	h.
47710-12	12	3,0
47710-16	16	4,0
47710-20	20	4,5
47710-24	24	5,0
47710-28	28	5,0
47710-32	32	5,5



Ciambella
Savarin tin
Savarinform
Moule pour savarin
Molde Savarin

art.	Ø cm.	h.	u.pack
47711-08	8	2,0	6
47711-12	12	2,5	6
47711-22	22	4,5	1
47711-24	24	5,0	1
47711-26	26	6,2	1



Tortiera festonata, fondo mobile
Round mold, fluted, loose bottom
Tortenform, gewellter Rand, Heheboden
Tourtière cannelée, fond amovible
Molde acanalado, rizado, fondo desmontable

art.	Ø cm.	h.
47712-20	20	2,5
47712-24	24	2,5
47712-28	28	2,5
47712-32	32	2,5



Tortiera trois frères
Trois Frères ring
Frankfurter Kranzform
Tourtière trois frères
Molde trois frères

art.	Ø cm.	h.	u.pack
47713-22	22	5,5	6



Stampo americano
Gugelhupf cake pan
Gugelhupfform
Moule à gugelhupf
Molde gugelhupf

art.	Ø cm.	h.
47705-22	22	10



Tortiera rettangolare
Loaf pan
Königskuchenform
Cake embouti
Molde rectangular

art.	dim. cm.	h.
47714-26	26x9,5	7,5
47714-28	28x10	7,5



Tortiera rettangolare apribile
Folding loaf pan
Aufklappbare-Königskuchenform
Cake ouvrant
Molde rectangular desmontable

art.	dim. cm.	h.
47715-30	30x10	7,5



Teglia rettangolare
Rectangular baking sheet
Rechteckige-Backform
Plaque rectangulaire
Placa rectangular

art.	dim. cm.	h.
47716-37	37x26	1,3



Tortiera fondo mobile
Rectangular mold, loose plate bottom
Backform, gerippt, Heheboden
Tourtière cannelée, fond amovible
Molde fondo desmontable

art.	dim. cm.	h.
47717-35	35x11	2,5



Tortiera margherita
Baking mold "Margherit"
Margeriten-Backform
Moule à marguerite
Molde margarita

art.	Ø cm.	h.
47718-20	20	6



Tortiera festonata, fondo mobile
Round mold, fluted, loose bottom
Tortenform, gewellter Rand, Heheboden
Tourtière cannelée, fond amovible
Molde acanalado, fondo desmontable

art.	Ø cm.	h.	u.pack
47719-10	10	3	6
47719-24	25	5	1



Tartelletta a barchetta
Oval boat mold
Schiffchenförmchen
Barquette unie
Molde barquilla

art.	Ø cm.	u.pack
47720-06	6	6
47720-08	8	6
47720-10	10	6
47720-12	12	6



Tartelletta a barchetta, festonata
Fluted oval boat mold
Schiffchenförmchen, gerippt
Barquette, cannelée
Molde barquilla, rizado

art.	Ø cm.	u.pack
47721-08	8	6
47721-10	10	6
47721-12	12	6



Tartelletta tonda
Round plain mold
Backförmchen, rund
Tartelette ronde, unie
Molde redondo

art.	Ø cm.	u.pack
47722-05	5	6
47722-06	6	6
47722-07	7	6
47722-08	8	6
47722-10	10	6



Tartelletta tonda festonata
Round fluted mold
Backförmchen, rund, gerippt
Tartelette ronde, cannelée
Molde redondo, rizado

art.	Ø cm.	u.pack
47723-05	5	6
47723-06	6	6
47723-07	7	6
47723-08	8	6
47723-10	10	6
47723-12	12	6



Tartelletta a brioche
Brioche mold
Brioche-Förmchen, gerippt
Brioche fond plat
Molde brioche

art.	Ø cm.	u.pack
47724-06	6	6
47724-08	8	6
47724-10	10	6
47724-11	11	6



Tartelletta rettangolare
Friand mold
Friand-Förmchen
Friand
Molde rectangular

art.	dim. cm.	u.pack
47725-09	10x5	6



Aspic ovale
Oval aspic mold, plain bottom
Ovale Aspikform, glatter Boden
Aspic ovale, fond uni
Molde oval

art.	dim. cm.	h.	u.pack
47726-07	7,5x5,5	3,8	6



Aspic ovale, fondo stella
Oval aspic mold, star bottom
Ovale Aspikform, Sternboden
Aspic ovale, étoilé
Molde oval, fondo estrella

art.	dim. cm.	h.	u.pack
47727-07	7,5x5,5	3,8	6



Stampo per babà
Rum baba mold
Runde Babaform
Dariole embouti
Molde para babà

art.	Ø cm.	h.	u.pack
47728-06	6	6	6

PASTICCERIA PASTRY UTENSILS
TORTIERE ANTIADERENTI NON STICK CAKE MOLDS



Scatola tartellette assortite
Box of small assorted molds
Satz Förmchen
Boîte petits fours, assortis
Surtido moldes



art.	pz. / pcs.
47730-24	24
47730-36	36
47730-60	60

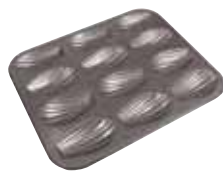

Stampo per madeleines
Madeleine sheet
Madeleine-Backblech
Plaque madeleines
Molde Madeleine

art.	dim. cm.	h.	cup.
47731-12	26x20	1,4	7,2x4



Stampo per madeinettes
Madeleine sheet
Madeleine-Backblech
Plaque madeinettes
Molde Madeleine

art.	dim. cm.
47732-20	39,5x12,5



Tortiera rettangolare
Cake mold
Königskuchenform
Cake évasé
Molde ensanchado

art.	dim. cm.	h.
47733-18	18x7,5	6,5
47733-24	24x9	7,5
47733-30	30x10	8,0
47733-36	36x10,5	8,0



Charlotte
Charlotte mold
Charlotte-Form
Charlotte
Molde Charlotte

art.	Ø cm.	h.	u.pack
47734-18	18	10	6



Bavarese
Bavarois mold
Bayerische-Kuchenform
Moule Bavarois
Molde Bávaro

art.	Ø cm.	h.
47735-18	18	9



Bacinella paté con cerniera
Loaf pan with hinges, loose bottom
Springkastenform, Hebeboden
Pâté à charnière, fond démontable
Molde con bisagra, fondo desmontable

art.	dim. cm.	h.
47736-30	30x8	8
47736-35	35x8	8
47736-40	40x8	8
47736-50	50x8	8



Stampo mini-paté
Mini paté mold
Pastetenkastenform
Mini-pâté à croûte
Molde minipaté

art.	dim. cm.	h.
47018-30	30x4	6
47018-50	50x4	6

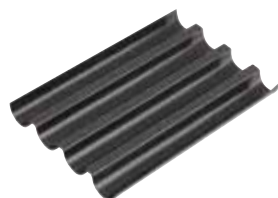

Teglia baguettes
Baguette baking pan
Baguetteform
Plaque à baguettes
Placa para baguettes

art.	dim. cm.	h.
47014-35	35x24,5	2,5



Tortiera festonata, fondo mobile
Square mold, fluted, loose bottom
Tortenform, gewellter Rand, Hebeboden
Tourtière carrée, cannelée, fond amovible
Molde cuadrado, rizado, fondo desmontable

art.	dim. cm.	h.
47738-23	23x23	2,5



Tortiera tonda
Round mold
Tortenform, rund
Tourtière ronde
Molde redondo

art.	Ø cm.	h.	u.pack
47739-12	12	2,1	6
47739-24	24	2,3	1
47739-28	28	2,3	1
47739-32	32	2,5	1



Tartelletta savarin
Savarin mold
Savarinförmchen
Savarin
Molde savarin

art.	Ø cm.	h.	u.pack
47757-65	6,5	1,5	6
47757-80	8,0	2,0	6



Tartelletta festonata, fondo mobile
Round fluted mold, loose bottom
Runde, gewellte Tortellets, Heheboden
Tartelette ronde cannelée, fond amovible
Molde redondo rizado, fondo desmontable

art.	Ø cm.	h.	u.pack
47758-10	10	1,8	6
47758-12	12	2,0	6



Tartelletta foglia di quercia
Oak leaf tart mold
Törtchenform Eichenblatt
Tartelette feuille chêne
Molde pasteles

art.	Ø cm.	h.	u.pack
47759-12	12	2	6



Tartelletta foglia di vite
Wine leaf tart mold
Törtchenform Weinblatt
Tartelette feuille vigne
Molde pasteles

art.	Ø cm.	h.	u.pack
47760-12	12	2	6



Tartelletta
Small mold
Pralinen-förm
Petit four
Molde pasteles

art.	Ø cm.	u.pack
47747-01	4,5	6



Tartelletta
Small mold
Pralinen-förm
Petit four
Molde pasteles

art.	Ø cm.	u.pack
47723-05	5	6



Tartelletta
Small mold
Pralinen-förm
Petit four
Molde pasteles

art.	Ø cm.	u.pack
47747-03	4,5	6



Tartelletta
Small mold
Pralinen-förm
Petit four
Molde pasteles

art.	Ø cm.	u.pack
47747-04	3,5	6



Tartelletta
Small mold
Pralinen-förm
Petit four
Molde pasteles

art.	Ø cm.	u.pack
47747-05	4,5	6



Tartelletta
Small mold
Pralinen-förm
Petit four
Molde pasteles

art.	Ø cm.	u.pack
47747-06	6	6



Tartelletta
Small mold
Pralinen-förm
Petit four
Molde pasteles

art.	Ø cm.	u.pack
47747-07	6	6



Tartelletta
Small mold
Pralinen-förm
Petit four
Molde pasteles

art.	Ø cm.	u.pack
47747-09	5	6



Tartelletta
Small mold
Pralinen-förm
Petit four
Molde pasteles

art.	Ø cm.	h.	u.pack
47747-10	4,0	1,0	6
47747-11	3,5	1,4	6



Stampo tartelletta
Cup bun pan
Backblech
Plaque tartelettes
Molde pasteles

art.	dim. cm.	h.	Ø
47748-35	35,5x27	2,5	6,5



Stampo pupazzo di neve
Snowman pan
Schneemann-Backblech
Plaque bonhomme de neige
Molde muñeco de nieve

art.	dim. cm.	h.
47763-31	31x19,7	5

PASTICCERIA PASTRY UTENSILS
TORTIERE ANTIADERENTI NON STICK CAKE MOLDS



Stampo pupazzo di neve
Snowman mold
Schneemann-Backblech
Plaque bonhomme de neige
Molde muñeco de nieve

art. dim. cm.
47762-23 23x5



Stampo Babbo Natale
Santa Claus mold
Weihnachtsmann-Backblech
Plaque Père Noël
Molde Papà Noel

art. dim. cm.
47761-23 23x4,8



Stampo di Natale
Christmas style mold
Weihnachts-Backblech
Plaque de Noël
Molde de Noel

art. dim. cm. h. cup ø
47750-06 31,5x21,5 2,5 8,3x2,5



Stampo motivi pasquali
Easter muffin pan
Ostern-Backblech
Plaque Pâque
Molde Pascua

art. dim. cm. h.
47749-35 35x27 3



Stampo uovo
Egg mold
Ostereierform
Moule à oeuf
Molde para huevos

art. dim. cm.
47007-26 26x8,3



Stampo coniglietto di Pasqua
Easter rabbit pan
Osternhase-Backblech
Plaque lapin de Pâque
Molde conejo de Pascua

art. dim. cm. h.
47764-10 10,8x14,5 3



Stampo coniglietto di Pasqua
Easter rabbit mold
Osternhase-Backblech
Plaque lapin de Pâque
Molde conejo de Pascua

art. dim. cm.
47764-12 12x2,6



Stampo coniglio di Pasqua
Easter rabbit mold
Osternhase-Backblech
Plaque lapin de Pâque
Molde conejo de Pascua

art. dim. cm.
47764-28 28x5,4



Stampo carré
Loaf pan
Königskuchenform
Cake évasé
Molde ensanchado

art. dim. cm. h.
47752-09 9,5x6 3,8



Stampo carré
Loaf pan
Königskuchenform
Cake évasé
Molde ensanchado

art. dim. cm. h.
47752-16 15x7,5 4,8



Stampo carré
Loaf pan
Königskuchenform
Cake évasé
Molde ensanchado

art. dim. cm. h.
47752-21 21x10,8 5,8

PASTICCERIA PASTRY UTENSILS



P



Stampo carré, fondo festonato
Fluted loaf pan
Königskuchenform, gerippt
Cake évasé, fond cannelé
Molde ensanchado, fondo rizado

art.	dim. cm.	h.
47753-31	31x12	5,0



P

Stampo apribile
Springform mold
Springform
Manqué démontable
Molde desmontable

art.	Ø cm.	h.
47754-20	20,5	6,5
47754-24	24,0	6,5
47754-26	26,0	6,5
47754-28	28,0	6,7



P

Stampo cuore
Heart pan
Herz-Backblech
Plaque coeur
Molde corazón

art.	dim. cm.	h.
47751-23	23x24,5	4,5



P

Stampo ciambella apribile
Fluted springform pan
Savarinspringform
Manqué savarin démontable
Molde savarin desmontable

art.	Ø cm.	h.
47756-20	20,5	4,7
47756-24	24,0	6,8
47756-26	26,0	6,5
47756-28	28,0	6,7

Stampo apribile, 6 fondi
Springform mold with 6 bottoms
Springform mit 6 Böden
Manqué démontable, 6 fonds
Molde desmontable, 6 fondos

art.	Ø cm.	h.
47755-26	26	6

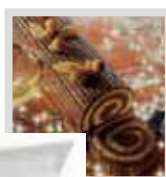

Tampone finto legno
Rubber comb, wood effect
Kamm aus Kunststoff, holzartig
Peigne faux bois
Peine de goma, efecto madera

art.	l. cm.
47684-15	15

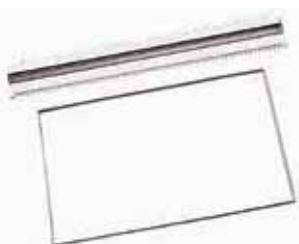

Pettine Charlotte con telaio, inox
Comb for Charlotte with frame, s/s
Charlotte-Kamme mit Rahmen, E. R.
Peigne à Charlotte avec cadre, inox
Peine para Charlotte con marco, inox

art.	dim. cm.
47670-02	57x36,5



Appoggiare il telaio su un tappetino di silicone e stendere il biscuit charlotte uniformemente. Posizionare il pettine sul telaio e tirarlo verso di sé. Put the frame on a silicone mat. Spread uniformly the charlotte biscuit. Place the comb on the frame between the guides and draw towards you.



Pettine inox con 5 fasce gomma
Stainless steel comb with 5 rubber blades
Kamm, Edelstahl mit 5 Gummiklingen
Peigne inox avec 5 bandes à décor
Peine inox con 5 láminas de goma

art.	dim. cm.
47672-05	70x10



Spalmare uniformemente la pasta decoro sul foglio di silicone. - Spread uniformly the decorating paste on the silicone sheet.



Appoggiare il pettine e tirare. Passare in congelatore. - Put the comb in the chosen direction. Put it in a freezer.



Stendere il biscuit. Cuocere in forno a 230° per 8 minuti. - Spread the biscuit on the motif obtained. Bake in oven at 230° C for 8 mins.



Appoggiare il biscuit su un foglio e togliere delicatamente il silicone. - Place the biscuit on a greaseproof paper sheet upside down and remove carefully the silicone sheet.



Tagliare le fasce di biscuit nella larghezza desiderata. - Cut the biscuit into stripes.



Mettere la fascia di biscuit nella forma desiderata. Put the stripes obtained in the mold previously chosen.

PASTICCERIA PASTRY UTENSILS
PREPARAZIONE PREPARATION TOOLS

GRIGLIA PER DECORO BISCUIT, INOX - GRILL FOR BISCUIT, STAINLESS STEEL
GITTER FÜR BISCUIT, EDELSTAHL ROSTFREI - GRILLE POUR BISCUIT, INOX - REJILLA PARA GALLETA, INOX



Appoggiare la griglia su un tappeto di silicone. Spatolare la pasta decoro uniformemente. Togliere la griglia e passare in congelatore. Successivamente stendere il biscuit. Cuocere in forno a 230°C per 8 minuti, appoggiare il biscuit capovolto su un foglio e togliere delicatamente il tappeto. Tagliare le fasce di biscuit nella larghezza desiderata - Place the grill on silicone mat. Spread uniformly the decorating paste. Take off the grid and put into refrigerator. Afterwards spread uniformly the biscuit. Bake in the oven at 230°C for 8 minutes. Place the biscuit upside down on a greaseproof paper and remove carefully the silicone mat. By using an extensible pastry cutter cut the biscuit into stripes.



art. 47674-01 dim. cm. 60x40



art. 47674-02 dim. cm. 60x40



art. 47674-03 dim. cm. 60x40



art. 47674-04 dim. cm. 60x40



art. 47674-05 dim. cm. 60x40



art. 47674-06 dim. cm. 60x40



art. 47674-07 dim. cm. 60x40



art. 47674-08 dim. cm. 60x40

PLACCA PER PASTA FROLLA, PLASTICA - COOKIE CUTTER FRAMES, PLASTIC
AUSSTECHEMATTE, KUNSTSTOFF - PLAQUE À PÂTE BRISÉE, PLASTIQUE - REJILLA PARA GALLETA, PLÁSTICO



93x37mm
5pcs

93x40mm
5pcs

93x40mm
5pcs

93x42mm
5pcs



art. 47675-10



Kit Griglia Taglia biscotti carnevale 60x40 cm e cutter per occhi.
Carnival biscuit cutter frame kit 60x40 cm and cutter for eyes.



art. 47675-01 dim. cm. 58x39 Ø 8,8 n. 20
47675-02 dim. cm. 58x39 Ø 4,5 n. 72

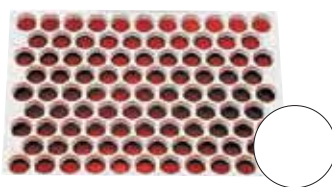

art. 47675-03 dim. cm. 58x39 Ø 5,5 n. 53

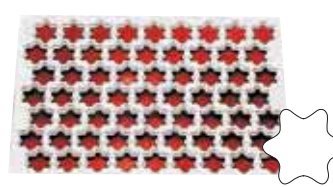

art. 47675-04 dim. cm. 58x39 Ø 5,2 n. 63

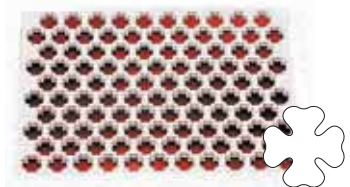

art. 47675-05 dim. cm. 58x39 Ø 4,5 n. 60

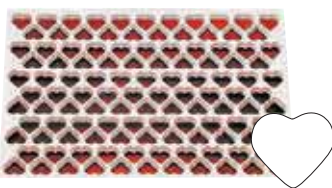

art. 47675-06 dim. cm. 58x39 Ø 4 n. 95

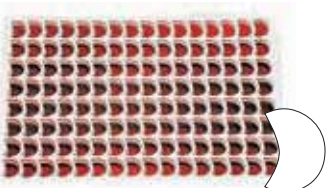

art. 47675-07 dim. cm. 58x39 Ø 5 n. 78



art. 47675-08 dim. cm. 58x39 Ø 5 n. 68

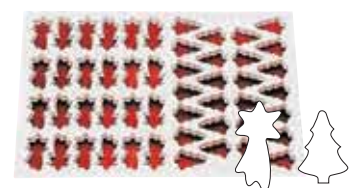

art. 47675-09 dim. cm. 58x39 Ø 7,5 n. 24
Ø 6,0 n. 26

GRIGLIA PER DECORO BISCUIT, PLASTICA - GRILL FOR BISCUIT, PLASTIC
5GITTER FÜR BISCUIT, KUNSTSTOFF - GRILLE POUR BISCUIT, PLASTIQUE - REJILLA PARA GALLETA, PLÁSTICO



Appoggiare la griglia su di un foglio in silicone. Spatolare la pasta decoro uniformemente. Place the grill on a silicone sheet. Spread the decorating paste.



Togliere la griglia e passare il decoro realizzato in congelatore. Take off the grill and put into refrigerator.



Stendere il biscuit aiutandosi con una cornice e una spatola. - Afterwards spread the biscuit using a frame and a spatula.

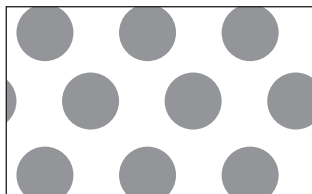

art. dim. cm. Ø
47677-01 60x40 0,7
47677-02 60x40 0,9



art. dim. cm.
47677-03 60x40

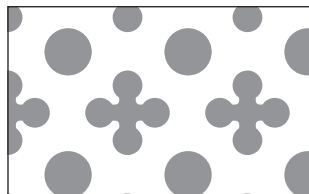

art. dim. cm.
47677-04 60x40

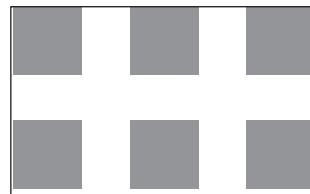

art. dim. cm.
47677-05 60x40



art. dim. cm.
47677-06 60x40



art. dim. cm.
47677-07 60x40



art. dim. cm.
47677-08 60x40



art. dim. cm.
47677-09 60x40



art. dim. cm.
47677-10 60x40

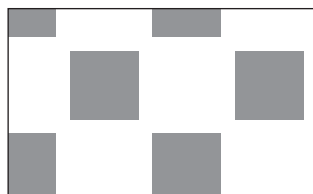

art. dim. cm.
47677-11 60x40



art. dim. cm.
47677-12 60x40



art. dim. cm.
47677-13 60x40



art. dim. cm.
47677-14 60x40

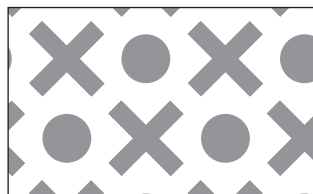

art. dim. cm.
47677-15 60x40

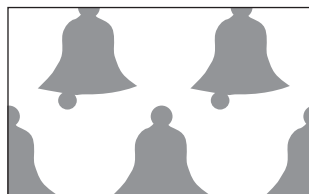

art. dim. cm.
47677-16 60x40



art. dim. cm.
47677-17 60x40



art. dim. cm.
47677-18 60x40

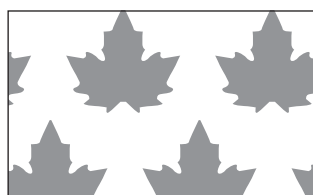

art. dim. cm.
47677-19 60x40



art. dim. cm.
47677-20 60x40



CORNICE, PST - FRAME
RAHMEN - CADRE - MARCO

art. dim. cm. h.
47677-23 60x40 0,3
47677-24 60x40 0,4
47677-25 60x40 0,5

TEGLIE MONOPORZIONI - MONOPORTION TRAY MOLDS

		96 forme/molds gr.20			35 forme/molds gr.75		
dim. cm.		Teglia Tray	Estrattore Extractor	Tagliapasta Cutter	Teglia Tray	Estrattore Extractor	Tagliapasta Cutter
	60x40	47651-01 ø 44 mm. h. 25 mm.	47656-01	47655-01	47652-01 ø 67 mm. h. 40 mm.	47658-01	47657-01
	60x40	47651-02 dim. 55x35 mm. h. 25 mm.	47656-02	47655-02	47652-02 dim. 86x50 mm. h. 40 mm.	47658-02	47657-02
	60x40	47651-03 dim. 46x46 mm. h. 25 mm.	47656-03	47655-03	47652-03 dim. 74x71 mm. h. 40 mm.	47658-03	47657-03
	60x40	47651-04 dim. 60x38 mm. h. 25 mm.	47656-04	47655-04	47652-04 dim. 90x58 mm. h. 40 mm.	47658-04	47657-04
	60x40	47651-05 dim. 58x39 mm. h. 25 mm.	47656-05	47655-05	47652-05 dim. 88x60 mm. h. 40 mm.	47658-05	47657-05
	60x40	47651-07 dim. 38x38 mm. h. 25 mm.	47656-07	47655-07	47652-07 dim. 59x59 mm. h. 40 mm.	47658-07	47657-07



Stencil
Stencil
Stencil
Stencil
Stencil

art. dim. cm. cm. pz./pcs
47875-11 31x51 13x3 30



Stencil
Stencil
Stencil
Stencil
Stencil

art. dim. cm. cm. pz./pcs
47875-13 31x51 7,5x3,5 40



Stencil
Stencil
Stencil
Stencil
Stencil

art. dim. cm. cm. pz./pcs
47875-14 31x51 6,5x4 32

STAMPI IN SILICONE PER PRALINE - PRALINE'S SILICONE MOLDS



Pratici stampi in silicone flessibili e resistenti per creazioni dolci o salate (snack, tartufi, gelatine, praline). Ideali per realizzare grandi quantità in poco tempo. Resistono da -40° a +280°C. Utilizzabili in forno, frigorifero e abbattitore.



Practical, flexible and resistant silicone molds for sweet or salty creations (snaks, truffles, jellies, pralines). Perfect to make large quantities in short time. They withstand from -40° to +280°C. Can be used in the oven, refrigerator and blast chiller.

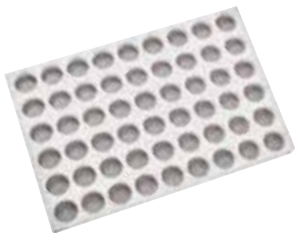

art. 47783-01 ø mm. 26 h. 14 pcs 54



art. 47783-02 dim. mm. 23x23 h. 14 pcs 54



art. 47783-03 dim. mm. 35x14,5 h. 14 pcs 63



art. 47783-04 dim. mm. 32x21 h. 14 pcs 49

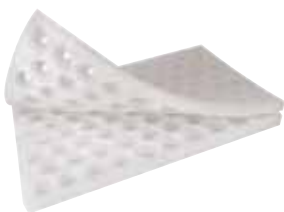

art. 47783-11 ø mm. 26 h. 14 pcs 54



art. 47783-12 ø mm. 30-10 h. 12 pcs 40



art. 47783-13 dim. mm. 90x30 h. 19 pcs 15



art. 47783-14 dim. mm. 90x30 h. 19 pcs 15



CIOCCOLATO - CHOCOLATE

STAMPI CIOCCOLATO - CHOCOLATE MOLDS
SCHOKOLADENFORMEN - MOULES À CHOCOLAT- MOLDES PARA CHOCOLATE



Stampi polycarbonato. Misure stampo 17,5x27,5 cm. - Polycarbonate chocolate molds. Mold size 17,5x27,5 cm.



art. 47860-36 dim. mm. 25x25 h. 25 pcs 40



art. 47860-37 dim. mm. 36x22 h. 20 pcs 36



art. 47860-85 dim. mm. 35x22 h. 16 pcs 35



art. 47860-35 ø mm. 30 h. 19 pcs 28



art. 47860-46 dim. mm. 35x20 h. 17 pcs 40



art. 47860-48 ø mm. 28 h. 24 pcs 40



art. 47860-49 ø mm. 30 h. 22 pcs 28



art. 47860-58 dim. mm. 17x12 h. 5 pcs 130



art. 47860-40 ø mm. 29 h. 21 pcs 40



art. 47860-68 ø mm. 28 h. 25 pcs 40



art. 47860-42 dim. mm. 35x23 h. 16 pcs 36



art. 47860-43 dim. mm. 38x28 h. 18 pcs 30



art. 47860-81 dim. mm. 30x18 h. 15 pcs 30



art. 47860-31 dim. mm. 33x25 h. 12 pcs 24



art. 47860-83 dim. mm. 30x30 h. 15 pcs 24



art. 47860-84 ø mm. 26 h. 19 pcs 35

PASTICCERIA PASTRY UTENSILS



art. 47860-18 ø mm. 27 h. 17 pcs 24



art. 47860-21 ø mm. 29 h. 18 pcs 24



art. 47860-27 dim. mm. 27x27 h. 13 pcs 28



art. 47860-17 dim. mm. 30x30 h. 12 pcs 24



art. 47860-24 dim. mm. 40x42 h. 15 pcs 15



art. 47860-74 dim. mm. 32x32 h. 4 pcs 24



art. 47860-75 dim. mm. 20x20 h. 16 pcs 28



art. 47860-38 dim. mm. 48x18,5 h. 19 pcs 16



art. 47860-44 dim. mm. 28x32 h. 15 pcs 32



art. 47860-39 dim. mm. 30x18 h. 15 pcs 30



art. 47860-50 ø mm. 26 h. 15 pcs 35



art. 47860-62 ø mm. 27 h. 20 pcs 30



art. 47860-53 dim. mm. 22x22 h. 22 pcs 28



art. 47860-55 dim. mm. 26x20 h. 21 pcs 28



art. 47860-56 ø mm. 24 h. 21 pcs 28



art. 47860-57 dim. mm. 26x20 h. 21 pcs 28



art. 47860-60 ø mm. 25 h. 18,5 pcs 28



art. 47860-61 dim. mm. 30x20 h. 17,5 pcs 28



art. 47860-63 ø mm. 27 h. 20 pcs 30



art. 47860-66 dim. mm. 25x25 h. 15 pcs 30



art. 47860-67 dim. mm. 25x25 h. 15 pcs 30



art. 47860-69 dim. mm. 40x20 h. 18 pcs 30



art. 47860-70 dim. mm. 40x18 h. 15 pcs 30



art. 47860-71 dim. mm. 26x26 h. 20 pcs 30



art. 47860-73 dim. mm. 31x22 h. 22 pcs 5x6





N

art. 47860-95 dim. mm. 25x25 h. 13 pcs 24



N

art. 47860-96 ø mm. 35 h. 15 pcs 24



N

art. 47862-31 dim. mm. 28x28 h. 16 pcs 28



N

art. 47862-32 dim. mm. 24x24 h. 18 pcs 28



N

art. 47862-34 dim. mm. 41x24 h. 20 pcs 20



N

art. 47862-35 dim. mm. 30x30 h. 11 pcs 28



N

art. 47862-36 dim. mm. 35x23 h. 17 pcs 24



N

art. 47862-33 dim. mm. 40x42 h. 16 pcs 15



N

art. 47862-38 dim. mm. 50x26 h. 3 pcs 16



N

art. 47862-39 dim. mm. 74x33 h. 5 pcs 12



N

art. 47862-03 dim. mm. 32x24 h. 29 pcs 24



N

art. 47862-04 dim. mm. 44x56 h. 39 pcs 12



N

art. 47862-05 ø mm. 40 h. 17 pcs 15



N

art. 47862-06 dim. mm. 33x31 h. 20 pcs 24



N

art. 47862-07 dim. mm. 33x33 h. 23 pcs 24



N

art. 47862-08 dim. mm. 44x55 h. 23 pcs 12



N

art. 47862-09 ø mm. 40 h. 18,5 pcs 15



N

art. 47862-10 ø mm. 32 h. 37 pcs 20



N

art. 47862C10 dim. cm. 38x10 h. 2,5 pcs 20

PASTICCERIA PASTRY UTENSILS



N

art. 47862-72 dim. mm. 110x7 gr. 3/4 pcs 22



N

art. 47862-73 dim. mm. 66x21 gr. 2/3 pcs 18



N

art. 47862-74 dim. mm. 65x22 gr. 2/3 pcs 18



N

art. 47862-75 dim. mm. 71-51-31 gr. 2/3 pcs 18



N

art. 47862-76 dim. mm. 73x72-54x51 gr. 2/3 pcs 18



N

art. 47862-77 dim. mm. 68x81-39x47 gr. 2/3 pcs 18



N

art. 47862-70 dim. mm. 64x26 gr. 2/3 pcs 16



N

art. 47862-71 dim. mm. 47x39 gr. 2/3 pcs 15



N

Lettere e numeri
Letters and numbers

art. 47860-86 h. mm. 30

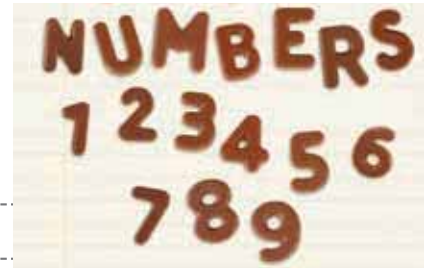

Semisfere
Half sphere

art.	ø mm.	gr.	pz/pcs
47860-76	30	4	24
47860-77	50	15	8
47860-78	100	90	2

N





Stampo magnetico per la realizzazione di praline serigrafate, PC
Magnetic mold to create silkscreened pralines, PC

art.	Ø mm.	gr.	pcs	art.	dim. mm.	gr.	pcs	art.	dim. mm.	gr.	pcs	art.	dim. mm.	gr.	pcs
47863-01	30	13	15	47863-02	33x25	15	15	47863-03	27x27	13	15	47863-04	27x25	10	15



Collocare il foglio serigrafato sul fondo dello stampo tagliandolo a misura. - Place the silk screen sheet on the base of the mold, cutting it to the right size.



Posare il foglio con la parte trasferibile verso l'alto e chiudere lo stampo. - Put the sheet with the transfer part facing upwards and close the mold.



Riempire gli stampi e lasciare solidificare il cioccolato. - Fill with chocolate and leave to cool.



Raffreddati, sformare i cioccolatini. When cool, open the mold and turn out the chocolates.



Tavolette cioccolato, set 5 pz, PE
Chocolate Bars, set 5 pcs
Schokoladentafel, 5-tlg
Tablettes chocolat, 5 pièces
Tabletas chocolate, 5 piezas

art.	dim. cm.
47870-17	15x17
47870-18	15x17
47870-19	15x17



PASTICCERIA PASTRY UTENSILS



Stampo cucchiaino, PC
Spoon mold, PC

art. dim. mm.
47860-90 25x95



Entrambe le misure si prestano come monoporzioni e per la realizzazione di dessert al piatto, mousse o semifreddo. - Both coffee pot measures are suitable to be used as a single portion or creation of desserts, as decoration with mousse or semifreddo.



Stampo tazzina e piattino, PC
Coffee cup and saucer mold, PC

art.		ø mm	h	pz/pcs	stampo/mold dim. cm
47860-91	tazza/cup	51	32	7	17,5x27,5
47860-92	tazza/cup	59	36	7	17,5x27,5
47860-93	piattino/saucer	80		5	17,5x27,5
47860-94	piattino/saucer	91		3	17,5x27,5



Stampo uovo, plastica rigida (PETG)
Egg mold, strong plastic (PETG)
Ostereierform
Moule à oeuf
Molde para huevos

Stampo uovo, PC
Egg mold, PC
Ostereierform, PC
Moule à oeuf, PC
Molde para huevos, PC

Stampo uovo, PE
Egg mold, PE
Ostereierform, PE
Moule à oeuf, PE
Molde para huevos, PE

art.	dim. cm.	kg.
47876-11	17x25	0,5-1,0
47876-12	18x28	0,8-1,2
47876-13	34x25	1,5-2,0
47876-14	27x40	2,0-2,5
47876-15	32x45	2,5-3,5
47876-16	36x54	4,0-6,0
47876-17	43x64	6,0-8,0
47876-18	50x75	8,0-10,0

art.	dim. mm.	gr.	half	pz/pcs
47862-80	44x64	25		10
47862-81	75x105	70		4
47862-82	90x130	150		2
47862-83	104x150	230		2
47862-84	121x175	260		1
47862-85	141x204	380		1
47862-86	157x227	430		1

art.	mm.	pcs
47865-44	220x160x85	1
47865-23	110x80x40	2
47865-80	112x83x44	2
47865-81	125x94x44	2
47865-82	140x100x50	2
47865-83	154x110x55	2



Stampo uovo, PE
Egg mold, PE
Ostereierform, PE
Moule à oeuf, PE
Molde para huevos, PE

Stampo uovo, PE
Egg mold, PE
Ostereierform, PE
Moule à oeuf, PE
Molde para huevos, PE

Stampo uovo, PE
Egg mold, PE
Ostereierform, PE
Moule à oeuf, PE
Molde para huevos, PE

art.	mm.	pcs
47865-66	80x60x25	4
47865-73	40x31x17	14
47865-71	36x23x12	18

art.	mm.	pcs
47865-77	140x100x49	1
47865-76	95x70x40	2
47865-75	83x54x24	4

art.	mm.	pcs
47865-74	64x44x26	6
47865-72	39x25x13	14

STAMPI 3D, CORPO CAVO, PC - 3D HOLLOW MOLDS, PC
3D-HOHLFORME, PC - MOULES CREUSES 3D, PC - MOLDE 3D, PC



art.	h. mm.	#
47793-11	170	1

art.	h. mm.	#
47793-12	180	1

art.	h. mm.	#
47793-13	140	1

art.	h. mm.	#
47793-14	195	1



art.	h. mm.	#
47793-15	170	2

art.	h. mm.	#
47793-16	150	1

art.	h. mm.	#
47793-17	160	2
47793-18	205	1

art.	h. mm.	#
47793-19	110	1
47793-20	160	1

PASTICCERIA PASTRY UTENSILS



art. 47793-21 h. mm. 125 # 2



art. 47793-22 h. mm. 125 # 2



art. 47793-23 h. mm. 110 # 3



art. 47793-24 h. mm. 145 # 1



art. 47793-25 h. mm. 97 # 2



art. 47793-26 h. mm. 110 # 1
47793-27 h. mm. 140 # 1



art. 47793-32 h. mm. 122 # 3



art. 47793-33 h. mm. 180 # 1



art. 47793-40 h. mm. 168 # 1



art. 47793-41 h. mm. 185 # 1



art. 47793-42 h. mm. 180 # 1



art. 47793-43 h. mm. 114 # 3



art. 47793-44 h. mm. 192 # 1



art. 47793-45 h. mm. 135 # 1



art. 47793-55 mm. 220x75x170 # 1



art. 47793-51 mm. 195x60x80 # 1



art. 47793-52 mm. 120 # 1



art. 47793-53 mm. 95x90x110 # 1



art. 47793-54 mm. 140x140x150 # 1



TUTTIFRUTTI Stampi in silicone cm 40x30, per realizzare dessert al piatto e monoporzioni.
Silicone molds cm 40x30, to create original dessert and surprising monoporzions.

PASTICCERIA PASTRY UTENSILS
STAMPI SILICONE SILICONE MOLDS



Fragola - Strawberry

art.	dim. mm.	h.	ml.	pcs
47745-10	71x54	46	90	20

Mela - Apple

art.	ø mm.	h.	ml.	pcs
47745-07	55	48	90	20



Pera - Pear

art.	ø mm.	h.	ml.	pcs
47745-06	53	70	90	20

Pesca/Ciliegia - Peach/Cherry

art.	dim. mm.	h.	ml.	pcs
47745-08	58x53	46	90	20

Madaraino - Tangerine

art.	ø mm.	h.	ml.	pcs
47745-09	57	50	90	20

60x40 CM



Galaxy

art.	ø mm.	h.	ml.	pcs
47746-07	175-55	55	1.000	6

60x40 CM



Curry

art.	dim. mm.	h.	ml.	pcs
47746-05	200x130	65	960	6

60x40 CM



Bilbao

art.	dim. mm.	h.	ml.	pcs
47746-09	250x85	75	1.150	8

40x30 CM



Planet

art.	ø mm.	h.	ml.	pcs
47745-01	38	20	18	30

60x40 CM



Planet

art.	ø mm.	h.	ml.	pcs
47746-06	180	45	1.000	6

60x40 CM



Plissée

art.	ø mm.	h.	ml.	pcs
47746-08	180	47	1.000	6



N

60x40 CM

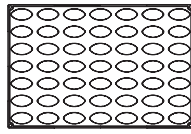

Quenelle

art.	mm.	h.	ml.	pcs
47746-01	66x33	30	32	49



N

60x40 CM

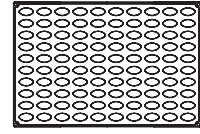

Mini quenelle

art.	mm.	h.	ml.	pcs
47746-02	42x20	20	8	100



N

60x40 CM

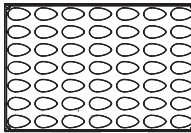

Quenelle tonda

art.	mm.	h.	ml.	pcs
47746-03	66x35	26	34	49



N

60x40 CM

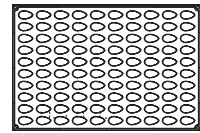

Mini quenelle tonda

art.	mm.	h.	ml.	pcs
47746-04	42x22	17	9	100



N

40x30 CM

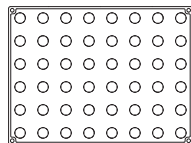

Sphere

art.	ø mm.	ml.	pcs
47745-02	20	4	48



N

40x30 CM

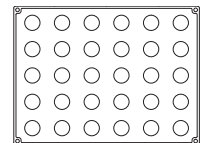

Sphere

art.	ø mm.	ml.	pcs
47745-03	30	14	30



N

40x30 CM

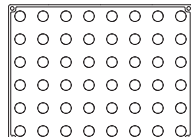

Sphere

art.	ø mm.	ml.	pcs
47745-04	40	33	24



N

40x30 CM

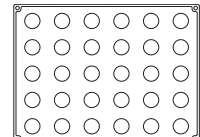

Sphere

art.	ø mm.	ml.	pcs
47745-05	50	65	20

Stampi microforati, formato 600x400 mm. Micro-perforated moulds, size 600x400 mm. Ideali per realizzare prodotti sia dolci che salati. Flessibili e multiuso. Semplici e veloci da usare, alta resa di produzione: da tartellette a brioche, da tortine classiche a moderne. Si ottiene una cottura uniforme anche dei prodotti da forno che faticano a cuocersi. La sablè, le frolle, la pasta brisée o qualsiasi altra pasta si aggrappa bene sui bordi, senza formare bolle e senza attaccarsi, evitando problemi di collassamento e valorizzando lo sviluppo della lievitazione in altezza.

Ideal for making both sweet and savoury products. Its flexible and multi-purpose feature. Quick and easy to use, it allows a high production yield and the creation of endless types of products: from tartlets to brioches, from classic to modern cakes. Ensures a homogeneous baking even for the most difficult products, such as cream or fruit tarts. The sablè, brisée, shortcrust and any other type of pastry grip to the edges, without bubbles or sticking, avoiding border collapsing and enhancing the correct rising of the product.



art. ø mm. h. ml. pcs
47775-06 40 16 16 60

art. ø mm. h. ml. pcs
47775-01 48 16 22 40

art. ø mm. h. ml. pcs
47775-08 65 20 57 24

art. ø mm. h. ml. pcs
47775-09 80 20 88 15



art. ø mm. h. ml. pcs
47775-11 100 20 140 12

art. ø mm. h. ml. pcs
47775-10 120 30 332 8

art. ø mm. h. ml. pcs
47775-12 150 30 495 6

art. mm. h. ml. pcs
47775-03 45x45 16 27 48



art. mm. h. ml. pcs
47775-04 65x65 20 71 24

art. mm. h. ml. pcs
47775-02 85x85 20 127 12

art. mm. h. ml. pcs
47775-05 120x120 30 374 8

STAMPI PER GELATINE - JELLY MOLDS
GELEEFORMEN - MOULES À GELÉES - MOLDES PARA GELATINAS

DIMENSIONE PLACCA - MOLDS SIZE: 18X33,5 CM



PZ. - PCS.: 24



Stampi in puro silicone alimentare, per la realizzazione di gelatine alla frutta, fondenti, ecc. Con telaio in plastica.
Silicone molds for fruit jelly, fondant, etc. With plastic frame.



47676-01

47676-02

47676-03

47676-04

47676-05

47676-06

47676-17

47676-18

47676-09

Fetta Arancio
Orange Slice

Pera
Pear

Cuore
Heart

Mezzasfera
Halfsphere

Bon Bon
Pastille

Mora
Berry

Ananas
Pineapple

Fragola
Strawberry

Pesca
Peach

dim. mm
45x18x15

dim. mm
40x26x15

dim. mm
34x30x18

dim. mm
ø27xh13,5

dim. mm
ø30xh11

dim. mm
ø30xh24

dim. mm
33x23x18

dim. mm
36x30x20

dim. mm
35x25x20

PLACCHE MULTIPORZIONE 400X300 MM MULTIPORTION TRAYS 400X300 MM

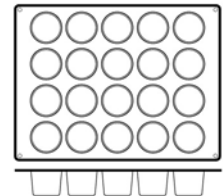
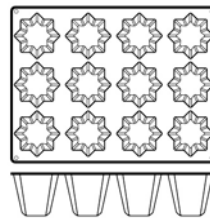
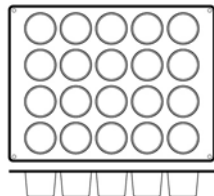
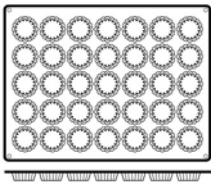

Fluted Muffins

art. ø mm. h. pcs
47780-01 50 15 35

Mini-Panettone

art. ø mm. h. pcs
47780-02 70 40 20

Mini-Pandoro

art. ø mm. h. pcs
47780-03 85 90 12

Muffins

art. ø mm. h. pcs
47780-04 70 42 12



LAVABILI IN LAVASTOVIGLIE
DISHWASHER SAFE



FREEZER -60°C(-76° F)



FORNO/OVEN +260°C (+500°F)



NON USARE CON FIAMME VIVE
DO NOT USE WITH FLAMES LIVE



NON USARE CON PIASTRA AD INDUZIONE
DO NOT USE WITH PLATE INDUCTION



NON TAGLIARE
DO NOT CUT WITH KNIFE



NON UTILIZZARE CON FORNELLETTI ELETTRICI
NOT USE WITH ELECTRIC COOKER



PRODOTTO CERTIFICATO ALIMENTARIETA'
FOOD GRADE



100% PRODOTTO IN ITALIA
100% MADE IN ITALY



MARCHIO DI QUALITA' ECOLOGICA
ECO BOXES



UTILIZZABILE IN MICROONDE
MICROWAVE SAFE



ATTENZIONE! CONDUTTORE DI CALORE!
MANEGGIARE CON CURA
BE CAREFUL WHILE YOU HANDLE

Pratici e funzionali, ideali sia per la surgelazione che per la cottura anche in forno a microonde. Possono essere utilizzati a temperature che variano da -60°C a +260°C. Facili da sformare, non attaccano e non necessitano di preparazione. Facili da lavare sia a mano che in lavastoviglie. Formato 17,5x30 cm equivalente a 1/3 Gastronorm ed a 1/4 del formato della teglia da pasticceria (cm 60x40). Realizzati in purissimo silicone conforme alle norme internazionali che regolano l'utilizzo di materiali destinati al contatto con sostanze alimentari: D.M. n. 104 del 21/03/1973 (legislazione italiana) - Arreté du 25/11/1992 (legislazione francese) - BGVV (legislazione tedesca) - FDA (legislazione statunitense).

Practical and functional, perfect for freezing or baking also in microwave ovens. Can be used with temperatures ranging from -60°C to +260°C. Easy to demold, does not stick. No need of preparation. Can be washed manually as well as into dishwashers. Dimension 17,5x30 cm equal to Gastronorm 1/3 and 1/4 of Baknorm size (cm 60x40). Manufactured in conformity with international regulations concerning food contact: D.M. no. 104 of 21/03/1973 (Italian law) - Arreté du 25/11/1992 (French law) - BGVV (German law) - FDA (USA law).

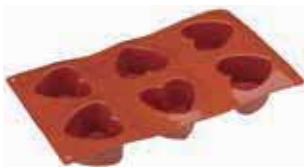

Hearts

art.	mm.	h.	pcs
47742-32	55x50	35	6



Hearts

art.	mm.	h.	pcs
47742-25	65x60	35	8



Maxi Muffins

art.	ø mm.	h.	pcs
47742-33	80	35	5

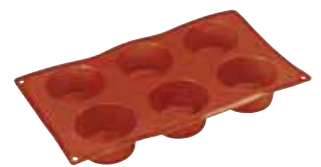

Muffins

art.	ø mm.	h.	pcs
47742-08	70	37	6



Mini-Muffins

art.	ø mm.	h.	pcs
47742-20	50	28	11



Briochettes

art.	ø mm.	h.	pcs
47742-12	79	37	6



Mini-Gugelhupf

art.	ø mm.	h.	pcs
47742-34	70	36	6



Tartelettes

art.	ø mm.	h.	pcs
47742-19	60	17	8

PASTICCERIA PASTRY UTENSILS



Mini-Madeleins
art. 47742-37 mm. 42x30 h. 11 pcs 20

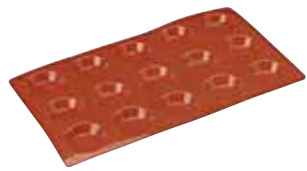

Tartelettes
art. 47742-16 ø mm. 50 h. 15 pcs 15



Madeleins
art. 47742-21 mm. 78x45 h. 17 pcs 9



Mini-Madeleins
art. 47742-36 mm. 42x33 h. 13 pcs 15



Financiers
art. 47742-28 mm. 80x30 h. 30 pcs 9



Cannelles
art. 47742-27 ø mm. 79 h. 30 pcs 6



Cannelles
art. 47742-41 ø mm. 50 h. 50 pcs 8



Mini-Cannelles
art. 47742-42 ø mm. 35 h. 35 pcs 18



Savarins
art. 47742-15 ø mm. 72 h. 23 pcs 6



Savarins
art. 47742-10 ø mm. 65 h. 21 pcs 8



Savarins
art. 47742-05 ø mm. 40 h. 12 pcs 18



Babà
art. 47742-02 ø mm. 55 h. 60 pcs 8



Babà
art. 47742-30 ø mm. 45 h. 48 pcs 11



Babà
art. 47742-31 ø mm. 35 h. 38 pcs 15



Half-Sphere
art. 47742-29 ø mm. 80 h. 40 pcs 5



Half-Sphere
art. 47742-01 ø mm. 70 h. 35 pcs 6



Half-Sphere
art. 47742-48 ø mm. 50 h. 25 pcs 15



Half-Sphere
art. 47742-03 ø mm. 40 h. 20 pcs 15



Half-Sphere
art. 47742-04 ø mm. 30 h. 15 pcs 24



Half-Sphere
art. 47742-47 ø mm. 60 h. 30 pcs 8

PASTICCERIA PASTRY UTENSILS
STAMPI SILICONE SILICONE MOLDS



Bavarese			
art.	ø mm.	h.	pcs
47742-51	60	50	8

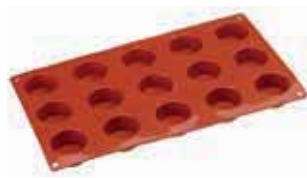

Muffins			
art.	ø mm.	h.	pcs
47742-24	40	20	15



Cakes			
art.	mm.	h.	pcs
47742-56	80x30	30	12



Ovals			
art.	mm.	h.	pcs
47742-09	53	33	16



Pyramids			
art.	mm.	h.	pcs
47742-07	71x71	40	6



Pyramids			
art.	mm.	h.	pcs
47742-13	36x36	22	15



Mini-Financiers			
art.	mm.	h.	pcs
47742-14	49x26	11	20



Cylinder			
art.	ø mm.	h.	pcs
47742-17	60	35	8



Pomponets			
art.	ø mm.	h.	pcs
47742-06	34	16	24



Cakes			
art.	ø mm.	h.	pcs
47742-61	80	18	6



Bisquits			
art.	ø mm.	h.	pcs
47742-23	103	20	3

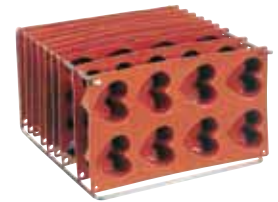

Sgocciatore - Drainer		
art.	dim.cm.	h.
47742-00	30x30	17,5

TORTIERE PIE PANS



Round Cake		
art.	ø mm.	h.
47765-26	260	40
47765-28	280	40



Plumcake		
art.	ø mm.	h.
47773-24	240x100	75
47773-28	280x105	75



Panettone			
art.	kg.	øcm.	h.
47785-10	1,00	23,5	14



Savarin		
art.	ø mm.	h.
47772-24	240	40



Heart		
art.	mm.	h.
47770-21	220x218	35



DEMARLE® FLEXIPAN



Flexipan®, un materiale che unisce fibra di vetro e silicone alimentare. Una combinazione che conferisce al prodotto una solidità e una longevità senza pari, oltre a straordinarie proprietà antiaderenti. Resistenza alla temperatura da -40°C a +280°C. Flexipan® è conforme alla regolamentazione europea e americana riguardante i materiali destinati al contatto con alimenti. Dal febbraio 1997 ha ottenuto la certificazione NSF®. Flexipan® ha ottenuto il riconoscimento da parte di FDA ed è approvato da LNE.

Altri prodotti e misure sono disponibili su richiesta.

Flexipan® is a combination of silicone and fiberglass designed for food use. This unique combination gives Flexipan® unequalled strength and durability, combined with exceptional non-stick properties. Heat resistant from -40°C to +280°C. Flexipan® has been granted NSF® International certification since February 1997. Approved by FDA (Food and Drug Administration-USA) and LNE.

Other products and sizes available on demand.



Mini-écrins

art.	mm.	h.	ml.	pcs
47740142	50x50	29	65	24



Mini-chenilles

art.	mm.	h.	ml.	pcs
47740143	102x40	36	90	27



Paesaggi - Landscapes

art.	ø mm.	h.	ml.	pcs
47740144	75	24	80	27



Crown muffins

art.	ø mm.	h.	ml.	pcs
47740-76	108/51	44	185	12



Little shells

art.	mm.	h.	ml.	pcs
47740-78	55x39	22	27	50



Oval savarins

art.	mm.	h.	ml.	pcs
47740-81	100x80	45	230	12



Little waves

art.	mm.	h.	ml.	pcs
47740121	79x49	25	76	24



Little cushion

art.	mm.	h.	ml.	pcs
47740-77	71x57	23	70	24



Scoop out

art.	mm.	h.	ml.	pcs
47740145	85x61	30	90	24



Lingotti/Porzione - Fluted ingots

art.	mm.	h.	ml.	pcs
47740127	106x46	25	90	24



Tavolette cioccolato - Chocolate bars

art.	mm.	h.	ml.	pcs
47740128	78x58	40	100	18



St Honoré - St Honoré crown

art.	ø mm.	h.	ml.	pcs
47740129	150	26	260	6



Esagoni - Hexagons

art.	ø mm.	h.	ml.	pcs
47740130	80	25	90	20



Mini St Honoré - Mini-St Honoré crown

art.	ø mm.	h.	ml.	pcs
47740131	80	20	70	18



Tartellette festonate - Fluted tartlets

art.	mm.	h.	ml.	pcs
47740132	78x78	20	70	24



Mini goccia - Mini drops

art.	mm.	h.	ml.	pcs
47740133	52x32	20	18	56



Pasticcini vari - Various petits-fours

art.	mm.	h.	ml.	pcs
47740134		22		60



Uova - Eggs

art.	mm.	h.	ml.	pcs
47740135	94x60	31	95	25



Campane - Bells

art.	mm.	h.	ml.	pcs
47740136	102x92	29	130	15



Annapurna

art.	mm.	h.	ml.	pcs
47740137	495x40	33	370	5



Chenille - Caterpillar

art.	mm.	h.	ml.	pcs
47740138	495x40	36	450	5

Venduto con supporto inox. - Sold with stainless steel frame.



Pesci - Fishes

art.	mm.	h.	ml.	pcs
47740139	99x59	25	100	18



Zaffiro - Zaphire

art.	mm.	h.	ml.	pcs
47740112	40x40	24	17	54



Zaffiro - Zaphire

art.	mm.	h.	ml.	pcs
47740113	70x70	35	75	24



Zaffiro savarin - Savarin zaphire

art.	mm.	h.	ml.	pcs
47740114	70x70	32	80	24



Mini cuori - Small hearts

art.	mm.	h.	ml.	pcs
47740115	41x38	16	15	70



Mini quadri - Small squares

art.	mm.	h.	ml.	pcs
47740116	37x37	17	18	60



Quadri - Squares

art.	mm.	h.	ml.	pcs
47740117	56x56	24	60	35



Cucchiaio - Spoon

art.	mm.	h.	ml.	pcs
47740118	90x28	12	15	36



Stelle - Stars

art.	mm.	h.	ml.	pcs
47740-88	80x65	15	35	24



Albero di Natale - Christmas tree

art.	mm.	h.	ml.	pcs
47740119	90x85	30	100	20



Lingotto - Ingot

art.	mm.	h.	ml.	pcs
47740122	120x40	25	100	24



Lingotto cavo - Hollow ingot

art.	mm.	h.	ml.	pcs
47740123	100x40	25	70	24
47740124	120x40	25	90	24



Semi cilindro - Half cylinder

art.	mm.	h.	ml.	pcs
47740125	85x17	15	20	48



Bavarese - Bavarois

art.	ø mm.	h.	ml.	pcs
47740105	78	35	100	18



Mini Charlotte

art.	ø mm.	h.	ml.	pcs
47740-82	35	15	9	60



Charlotte

art.	ø mm.	h.	ml.	pcs
47740-80	62	35	60	24



Charlotte

art.	ø mm.	h.	ml.	pcs
47740-23	78	40	100	18



Mini Madeleines

art.	mm.	h.	ml.	pcs
47740106	52x33	15	15	56



Madeleines

art.	mm.	h.	ml.	pcs
47740-17	78x47	19	35	40



Capesante - Shells

art.	mm.	h.	ml.	pcs
47740-79	80x75	20	70	24



Cuori - Hearts

art.	mm.	h.	ml.	pcs
47740-41	66x62	35	90	20



Cuori - Hearts

art.	mm.	h.	ml.	pcs
47740-89	75x65	35	81	20



Cuori intrecciati - Interlacing hearts

art.	mm.	h.	ml.	pcs
47740101	120x113	35	200	8



Mini cono - Small cones

art.	ø mm.	h.	ml.	pcs
47740-99	30	20	6	96



Inserto cono - Cone insert

art.	ø mm.	h.	ml.	pcs
47740102	50	40	24	40



Coni - Cones

art.	ø mm.	h.	ml.	pcs
47740103	70	60	80	20



Mini Savarin - Small Savarins

art.	mm.	h.	ml.	pcs
47740107	7x37	17	15	60



Savarin quadri - Square Savarins

art.	mm.	h.	ml.	pcs
47740108	56x56	24	45	35



Savarin quadri - Square Savarins

art.	mm.	h.	ml.	pcs
47740-96	70x70	30	100	24



Mini quadri - Small squares

art.	mm.	h.	ml.	pcs
47740109	45x45	12	20	60



Quadri - Squares

art.	mm.	h.	ml.	pcs
47740110	60x60	15	40	40



Mini piramidi - Small pyramids

art.	mm.	h.	ml.	pcs
47740-12	35x35	23	15	54



Piramidi fondo tronco - Pyramids flat bottom

art.	mm.	h.	ml.	pcs
47740-39	50x50	35	50	35



Piramidi - Pyramids

art.	mm.	h.	ml.	pcs
47740-13	71x71	41	90	24



Tronchetto natalizio - Christmas log

art.	mm.	h.	ml.	pcs
47740-26	95x40	30	80	24



Tronchetto natalizio - Christmas log

art.	mm.	h.	ml.	pcs
47740-27	122x42	32	115	24



Tronchetto natalizio - Christmas log

art.	mm.	h.	ml.	pcs
47740-28	339x40	39	450	8



Ceppo natalizio - Christmas log insert

art.	mm.	h.	ml.	pcs
47740-93	495x40	39	700	5



Savoardi - Champagne biscuits

art.	mm.	h.	ml.	pcs
47740-29	109x24	10	20	45



Rettangoli - Rectangular cakes

art.	mm.	h.	ml.	pcs
47740-25	80x30	30	55	24



Rettangoli - Rectangular cakes

art.	mm.	h.	ml.	pcs
47740-24	89x46	25	110	25



Lingotto - Ingot

art.	mm.	h.	ml.	pcs
47740-94	102x58	30	139	18



Tartina festonata - Fluted cakes

art.	mm.	h.	ml.	pcs
47740-95	110x60	25	105	16



Mini financiers - Small financiers

art.	mm.	h.	ml.	pcs
47740-09	50x26	11	10	84



Finanzieri - Financiers

art.	mm.	h.	ml.	pcs
47740-10	86x46	14	45	24



Mini semisfera inversa - Small upside-down half sphere

art.	ø mm.	h.	ml.	pcs
47740-86	26	16	6	45



Mini semisfera - Small half sphere

art.	ø mm.	h.	ml.	pcs
47740-87	26	16	6	96



Mini semisfera - Small half sphere

art.	ø mm.	h.	ml.	pcs
47740-01	29	18	10	70



Semisfera - Half sphere

art.	ø mm.	h.	ml.	pcs
47740-02	42	21	20	48



Semisfera - Half sphere

art.	ø mm.	h.	ml.	pcs
47740-37	58	31	50	28



Semisfera - Half sphere

art.	ø mm.	h.	ml.	pcs
47740-03	70	40	105	24



Semisfera - Half sphere

art.	ø mm.	h.	ml.	pcs
47740-38	80	40	125	24



Mini savarin - Small savarins

art.	ø mm.	h.	ml.	pcs
47740-14	41	12	10	60



Savarin - Savarins

art.	ø mm.	h.	ml.	pcs
47740-20	66	20	50	35



Savarin - Savarins

art.	ø mm.	h.	ml.	pcs
47740-15	70	23	65	24



Fondis per crostate - Flan bases

art.	ø mm.	h.	ml.	pcs
47740-43	80	20	70	24



Orso - Teddy bear

art.	mm.	h.	ml.	pcs
47740-53	90x55	20	80	18



Mini savarin ovali - Small oval savarins

art.	mm.	h.	ml.	pcs
47740-98	40x30	12	9	60



Savarin ovali - Oval savarins

art.	mm.	h.	ml.	pcs
47740111	70x50	22	48	30



Savarin ovali - Oval savarins

art.	mm.	h.	ml.	pcs
47740-44	80x60	25	70	24



Esagono - Exagon

art.	mm.	h.	ml.	pcs
47740-83	45x40	12	12	60

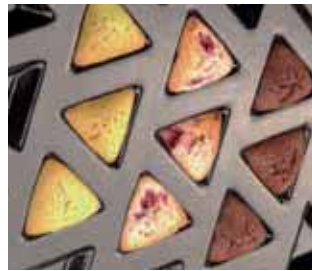

Triangoli - Triangles

art.	mm.	h.	ml.	pcs
47740-35	48x41	10	7	80



Ottagono - Optagon

art.	mm.	h.	ml.	pcs
47740-34	43x40	26	28	40



Losanghe - Rhombus

art.	mm.	h.	ml.	pcs
47740-36	60x35	10	9	70



Medaglioni - Medallions

art.	ø mm.	h.	ml.	pcs
47740-97	28	8	5	96



Pomponnettes

art.	ø mm.	h.	ml.	pcs
47740-04	36	17	14	96



Medaglioni - Medallions

art.	ø mm.	h.	ml.	pcs
47740-50	38	10	14	54



Mini quiches - Small quiches

art.	ø mm.	h.	ml.	pcs
47740-33	40	20	22	54



Mini quiches - Small quiches

art.	ø mm.	h.	ml.	pcs
47740-07	42	10	13	60



Mini quiches - Small quiches

art.	ø mm.	h.	ml.	pcs
47740-08	48	15	20	48



Mini quiches - Small quiches

art.	ø mm.	h.	ml.	pcs
47740-84	58	20	35	40



Quiches

art.	ø mm.	h.	ml.	pcs
47740-30	77	20	65	24



Quiches

art.	ø mm.	h.	ml.	pcs
47740-85	96	25	135	15



Mini tartellette festonata - Small fluted tartlet

art.	mm.	h.	ml.	pcs
47740100	46x38	15	11	40



Mini tartellette ovale - Small oval tartlet

art.	mm.	h.	ml.	pcs
47740-31	66x27	11	10	48



Tartellette ovale - Oval tartlet

art.	mm.	h.	ml.	pcs
47740-32	106x45	15	35	30

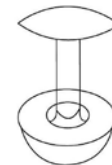

Tagliapasta - Pastry cutter

art.	Adatto agli stampi:
47740-AA	07-08-34-31
	Fits references: 07-08-34-31



Mini ovali - Small ovals

art.	mm.	h.	ml.	pcs
47740-11	51x31	20	20	50



Ovali - Ovals

art.	mm.	h.	ml.	pcs
47740-49	96x45	28	80	24



Mini quenelles - Small quenelles

art.	mm.	h.	ml.	pcs
47740-90	42x26	20	56	72



Mini ovali fondo piatto - Small ovals flat bottom

art.	mm.	h.	ml.	pcs
47740-91	57x35	12	18	64



Ovali - Ovals

art.	mm.	h.	ml.	pcs
47740-46	70x50	25	55	30
47740-47	70x50	30	75	30



Ovali - Ovals

art.	mm.	h.	ml.	pcs
47740-48	85x60	30	100	20



Quiches

art.	mm.	h.	ml.	pcs
47740-45	60x40	25	30	42



Mini cilindri - Small cylinders

art.	ø mm.	h.	ml.	pcs
47740-51	40	20	25	48



Cilindri - Cylinders

art.	ø mm.	h.	ml.	pcs
47740-52	63	25	65	24
47740-06	63	35	90	24



Muffins

art.	mm.	h.	ml.	pcs
47740-19	73	40	125	24
47740-68	79	36	115	24



Mini muffins - Small muffins

art.	ø mm.	h.	ml.	pcs
47740-67	51	29	45	40



Cilindri - Cylinders

art.	ø mm.	h.	ml.	pcs
47740-69	82	50	220	15
47740-70	91	35	190	15



Budini - Puddings

art.	mm.	h.	ml.	pcs
47740104	65	55	128	15



Tondo - Round

art.	ø mm.	h.	ml.	pcs
47740-63	125	16	75	11



Ovali - Ovals

art.	mm.	h.	ml.	pcs
47740-92	70x30	10	15	48



Ovali - Ovals

art.	mm.	h.	ml.	pcs
47740-55	130x48	18	80	24



Brioche tonde - Round brioche

art.	ø mm.	h.	ml.	pcs
47740-56	79	15	65	24



Brioche festonate - Fluted brioche

art.	mm.	h.	ml.	pcs
47740-57	62x49	26	60	24



Brioche festonate - Fluted brioche

art.	ø mm.	h.	ml.	pcs
47740-58	68	25	60	24
47740-59	78	30	105	24
47740-16	81	37	105	24



Biscotti - Cookies

art.	ø mm.	h.	ml.	pcs
47740-18	59	13	30	40
47740-60	78	10	50	24



Biscotti - Cookies

art.	ø mm.	h.	ml.	pcs
47740-61	91	8	60	15



Tarte tatin

art.	mm.	h.	ml.	pcs
47740-73	82	30	135	15



Quiches

art.	ø mm.	h.	ml.	pcs
47740-62	102	20	140	15



Quiches

art.	ø mm.	h.	ml.	pcs
47740-64	147	12	200	6
47740-65	150	15	250	6
47740-66	166	12	240	6



Quiches

art.	ø mm.	h.	ml.	pcs
47740-71	140	25	360	6
47740-72	150	24	390	6
47740-05	186	12	300	6



Biscotti - Cookies

art.	ø mm.	h.	ml.	pcs
47740-74	100	35	245	12
47740-75	105	40	305	12



Mezzo uovo - Half egg

art.	mm.	h.	ml.	pcs
47740140	55x35	20	20	56



Farfalla - Butterfly

art.	mm.	h.	ml.	pcs
47740141	70x60	20	60	24



Tagliapasta cucchiaio - Spoon pastry cutter

art.
47740-AB



Tagliapasta a stella - Star pastry cutter

art.
47740-AC



Tagliapasta cuore - Heart pastry cutter

art.
47740-AD



Perle - Pearls

art.	ø mm.	h.	ml.	pcs
47743-65	73	40	100	15



Stelle - Stars

art.	mm.	h.	ml.	pcs
47741121	90x75	25	95	8



Tartelletta ovale - Oval tartlet

art.	mm.	h.	ml.	pcs
47741-32	106x45	15	35	15



Mini cuori - Small hearts

art.	mm.	h.	ml.	pcs
47741-78	52x49	10	15	30



Mini semisfera - Small half sphere

art.	ø mm.	h.	ml.	pcs
47741-76	23	11	5	63



Semisfera piatta - Half sphere flat

art.	ø mm.	h.	ml.	pcs
47741-77	30	13	10	48

DEMARLE 60x40 CM FLEXIPAT



Cilindro - Cylinder

art.	ø mm.	h.	ml.	pcs
47744-30	70	40	148	24



Cubo - Cube

art.	mm.	h.	ml.	pcs
47744-32	30x30	20	17	96



Kougloff

art.	ø mm.	h.	ml.	pcs
47744-31	80	54	150	24



Basic chic

art.	mm.	h.	ml.	pcs
47744-33	70x70	34	130	24



Diamante - Diamond

art.	ø mm.	h.	ml.	pcs
47744-34	79	40	100	24

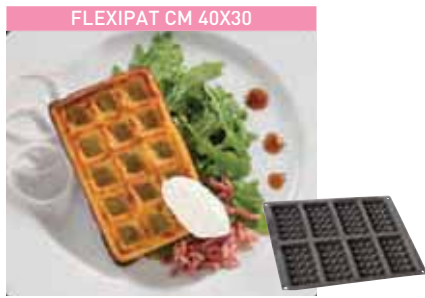

FLEXIPAT CM 40X30
Waffels
art. mm. h. ml. pcs **N**
47741-38 80x127 15 100 8



FLEXIPAT CM 40X30
Fingers
art. mm. h. ml. pcs **N**
47741-37 129x28 15 54 24



FLEXIPAT
Buche
art. mm. h. cl. **N**
47744-80 280x85 70 140



FLEXIPAT
1/2 sphère
art. ø mm. h. ml. **N**
47744-81 180 90 1600



FLEXIPAT
Flexiform desserts
art. mm. h. cl. **N**
47744-58 253x253 45 222



FLEXIPAT
Flexiform desserts
art. mm. h. cl. **N**
47744-59 600x400 50 980



FLEXIPAT
Flexiform desserts
art. mm. h. GN
47744-48 480x280 13 1/1
47744-60 555x360 10
47744-62 555x360 20





Rosette

art. ø mm.
47744-10 240



Venetian cane

art. mm.
47744-19 555x360

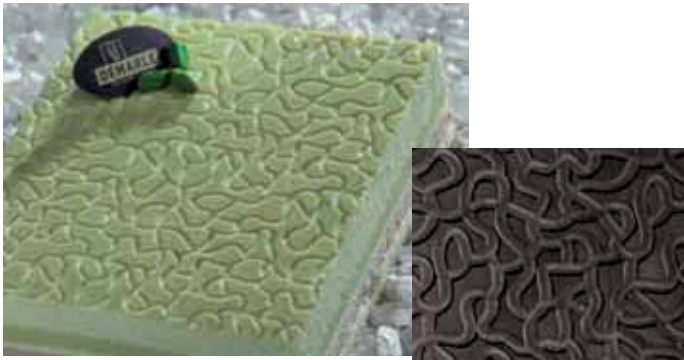

Labyrinth

art. mm.
47744-21 600x400



Snowflake

art. mm.
47744-63 240



Buche1

art. mm. N
47744-71 275x185



Buche2

art. mm. N
47744-70 275x185



Bubbles

art. mm. N
47744-36 600x400

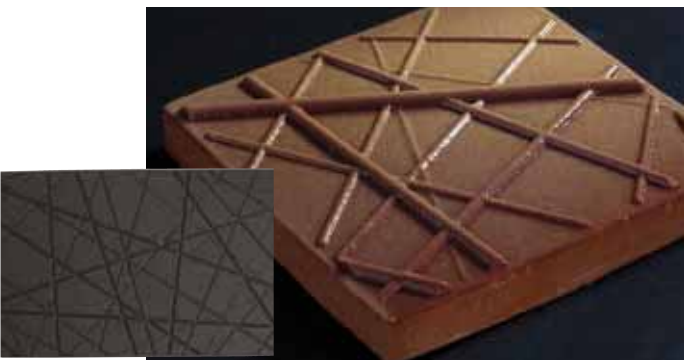

Mikado

art. mm. N
47744-37 600x400

BIGNE' - PUFFS - WINDBEUTEL - CHOUX - BOLLOS

Supporto alveolare Silform® per cottura di pasta bigné.
Questa gamma è stata sviluppata in particolare per la pasta di bigné. Grazie alle impronte preformate, preparare bigné uguali e regolari diventa facile. Non è più indispensabile né spennellare con tuorlo né forare la pasta. Grazie alle proprietà antiaderenti del Silform®, l'estrazione è impeccabile. La base del bigné sarà chiara e netta conferendogli così una perfetta stabilità. Silform® for Choux Pastry.

This range has been developed especially for cream puffs dough. The pre-formed shapes make easy obtaining perfect, regular and same size cream puffs. Neither greasing the sheet nor spiking the dough is required before baking. The non-stick property of the material allows an easy and perfect extraction of the pastries. The base of the puff will be clear and plain for perfect stability.



Paris-Brest

art.	ø mm.	h.	ml.	pcs
41760-27	80	15	50	24



Baby choux

art.	ø mm.	h.	ml.	pcs
41760-22	30	5	4	59



Oval choux

art.	mm.	h.	ml.	pcs
41760-26	90x60	15	56	25



Big choux

art.	mm.	h.	ml.	pcs
41759-01	67	15	48	28



Eclairs

art.	mm.	h.	ml.	pcs	
41760-20	125x25	5	15	18	right handed



Eclairs

art.	mm.	h.	ml.	pcs	
41760-21	125x25	5	15	18	left-handed





*
ARCTURUS GROUP

www.hotel.paderno.it
www.hotel.sambonet.it

XA9032 - Ed. 10/2017

